



ELECTROUSTIC
DISTRIBUTION OF CONNECTIVITY SOLUTIONS

Breath of fresh air with Lapp

Quality and innovation from a single source



LAPP GROUP

The Lapp Group



Headquarters in Stuttgart



Lapp-Center in Stuttgart

The Lapp Group provides a complete range of cables for all manner of industries and markets. Sourcing from a single supplier means competent advice and consistently high quality down to the last detail for designers, planners and manufacturers. Not only that, they can also be sure that all components are perfectly harmonised and enjoy fast, hassle-free ordering. Lapp Group products are manufactured in the Lapp Group production plants.

Over 40.000 different standard products are currently available off the shelf. In addition, special cables are developed and produced to create individual customer solutions.

To contact your local Lapp Group representative please visit www.lappgroup.com/worldwide

Power and control cables

Wide range use

- PVC sheath and coloured cores
- PVC sheath and numbered cores
- Halogen-free
- PVC sheath, approved
- Halogen-free
- PVC sheath, approved

Harsh use conditions

- Increased mechanical and chemical resistance

Wide range use

- PVC sheath, approved

Harsh use conditions

- Increased mechanical and chemical resistance

Special applications

- Windmills

Power chain applications

- Wide range use, approved

Special applications

- Oil & Gas industry

Expanded ambient temperatures

- Silicone cables (-50°C up to +180°C)
- FEP cables (-100°C up to +205°C)
- PTFE cables (-190°C up to +260°C)
- E-cross linked single cores (-55°C up to +125°C)
- Silicone single cores (-50°C up to +180°C)

Power chain applications

- Torsion, articulated robot

Harsh use conditions

- Rubber cables

Control Cabinet Single Cores

- Wide range use

Building Installation

- Cables for direct burial

Control Cabinet Single Cores

- Harmonized and approved

Harnessed cables

- Harnessed ground straps

Data communication systems

Data cables low frequency

- DIN colour code
- Halogen-free
- UL/CSA approved
- Highly flex.
- Highly flexible and UL/CSA approved
- Cable for sensor / actuator components
- Installation cable for industrial electronics

Cables for CC-Link

- Cables for CC-Link

Cables for CAN UL/CSA-approved

- Stationary application/highly flexible application

Telephone cables

- Halogen-free installation and fire alarm cables

Data communication systems for ETHERNET-Technology

Accessories for INDUSTRIAL networking

- LAN cables for industrial cabling

Optical transmission systems

For communication technology

- Duplex Jumper and Pigtails
- POF cables
- GOF cables

EPIC® Industrial connectors

- EPIC® KITS

Cable glands

- SKINTOP® cable glands polyamide metric
- SKINTOP® cable glands polyamide metric
- SKINTOP® bending protection
- SKINTOP® cable glands nickel plated brass metric
- SKINTOP® MS-M
- SKINTOP® EMC/Earthing
- SKINTOP® cable gland accessories metric
- SKINDICHT® counter nuts
- SKINTOP® multiple seal / dust protection
- SKINDICHT® cable glands plastic or metal metric
- SKINDICHT® special seal cable glands
- SKINDICHT® cable gland accessories metric
- SKINTOP® Counter nuts
- SKINDICHT® Blind plugs

Protective Cable Conduit Systems and Cable Carrier Systems

- Protective cable conduit systems parallelly corrugated
- SILVYN® RILL
- Protective cable conduit systems metal
- Protective cable conduit system SILVYN® SSUE
- Protective cable conduit systems liquid-tight
- Protective cable conduit system SILVYN® LCC-2 / LCCH-2
- Cable Marking
- Marking Guide
- Appendix
- Selection Tables
- Technical Tables



Source: PowerWind GmbH

Lapp brings a breath of fresh air for wind turbines

Wind energy plays an important role in the Lapp Group. To reflect the importance of this industry, the SBU Wind (Strategic Business Unit Wind) has been set up, and specialises in products and services for the industry.

Our customers can rely on 50 years of experience, marked by the very highest levels of quality and innovation. A range of over 40,000 items worldwide is available to our customers and shows Lapp's all-round expertise, not just in the wind energy sector.

No matter which cables our customers choose for their wind turbines, they can count on the very highest standards in terms of function, reliability and service life every time.

Many of the products from Lapp's standard range have already proved their worth in wind energy.

For example, the ÖLFLEX® CLASSIC 110 has been in continuous use in the drip loop for more than 10 years. The high quality that Lapp demands from all its products meant that it has withstood the extreme requirements in the drip loop until this very day and is still doing its job.

We have summarised the products that are already being used in nacelles, towers or the drip loop for you in our new "Special wind energy catalogue".

Take advantage of the many sources of information:

- Our main catalogue 2008/2009 (E + D)
- Our special catalogues on our homepages at www.lappgroup.com/en/wind.
- Market-specific products on the relevant homepages of our worldwide subsidiaries
- Your personal sales office
- Our worldwide product managers
- SBU Wind Managers – Strategic Business Unit Wind Managers – in many countries, who deal specifically with the needs of this sector.

We wish you every success in selecting your products.

Lapp is a single source for system products

For nacelle and tower:

- Halogen-free control and data cables
- Halogen-free cable glands
- Complete UL/CSA range:
Listed with UL/CSA, MTW, **NEW!**
WTTTC (Wind Turbine Tray Cable
for 1000 V outdoor installation)
and AWM approved cables.
- Flexible rectangular or circular connector
systems including modular systems
- Marking systems for every temperature
range and application with CAD
integration
- Practically tested cable systems for
connections between slip ring and pitch
control in the hub
- Circular and flat braids for lightning
protection

For drip loop:

- Torsion-resistant control and data cables
($\pm 150^\circ$ / metre), screened and
standard
- Torsion-resistant ETHERNET data cables
($\pm 180^\circ$ / metre)
- Torsion-resistant UL and MIL, listed fibre
optic cables ($\pm 110^\circ$ / metre)
- Torsion-resistant power cables
($\pm 150^\circ$ / metre)



Source: PowerWind GmbH



Source: PowerWind GmbH

Our international brands



ÖLFLEX® Power- and control cables

ÖLFLEX® is used in machinery, machine tools, system and appliance engineering, measuring, control, heating and air conditioning technologies. For permanent connections or in cable chains, halogen-free

or internationally certified, you can choose from our comprehensive range of standard products.



UNITRONIC® Data communication systems

Lapp produces a full range of data cables for fast and secure transfers of large volumes of data. From machine electronics and bus systems to super-fast LAN data

networks or highly-versatile applications: We have the data cables you need for virtually any situation.

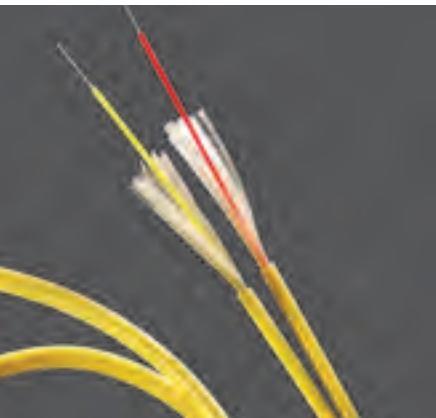

HITRONIC® Optical transmission systems

HITRONIC® fibre optic cables are designed to transfer large volumes of data. Communications media via fibre optics are fast, efficient, and secure. Not even electromagnetic interference can affect HITRONIC®

fibre optic cable. The HITRONIC® range of products includes cables for office communications, industrial applications, simplex, duplex, hybrid wiring, or cable chain applications.



SKINTOP® Cable glands

SKINTOP® cable glands guarantee secure connections every time. Simply thread the cable and twist. That's all! Your cables are perfectly centered, secured, hermetically sealed, and ready for action. Choose from

a wide range of models in plastic or brass, for EX and EMC applications, halogen-free types or anti-kink protection, metric, PG or NPT.

Our international brands

SILVYN® Protective cable conduit systems and cable carrier systems

In many applications cables have to be additionally protected against mechanical and chemical stress. For this type of application, Lapp Group can supply the universal **SILVYN®** protective cable conduit program. Cable conduits manufactured from metal or plastic material, which can be used with matching glands to form a perfect

system connection. The complete system results in all round protection for cables in indoor and outdoor installations. With **SILVYN® CHAIN**, Lapp Group's widely variable programme of power chains we offer both cable protection and guidance for highly dynamic applications.



FLEXIMARK® Cable marking products

Labels on single cores, cables, and control cabinets need to remain legible for years to come. This is the best way to keep things well organized and avoid potential problems.

From plastic to durable stainless steel, manual or electronic identification, with **FLEXIMARK®** you can be sure that your labels will last a lifetime.



EPIC® Industrial connectors

When we talk about secure connections, you can take us at our word. **EPIC®** industrial connectors produce an absolutely secure connection in combination with ÖLFLEX® cables. We provide the right contact for all

your needs: From rectangular or circular connectors, to housings, inserts, contacts and accessories, bus or fibre optic cable applications.



ETHERLINE® Data communication systems for ETHERNET-Technology

The Lapp Group is now in a position to offer comprehensive system solutions in the field of industrial networking. Its Factory Automation division supplies active network components that are used to supplement existing cable and plug technologies. These include services and security systems incor-

porating firewall solutions, in addition to distribution components such as switches, routers, cables and plug connectors. For its industrial customers, all of this means that a solution from the Lapp Group represents a considerable step forward in terms of security, safety and availability.



The Lapp Group worldwide

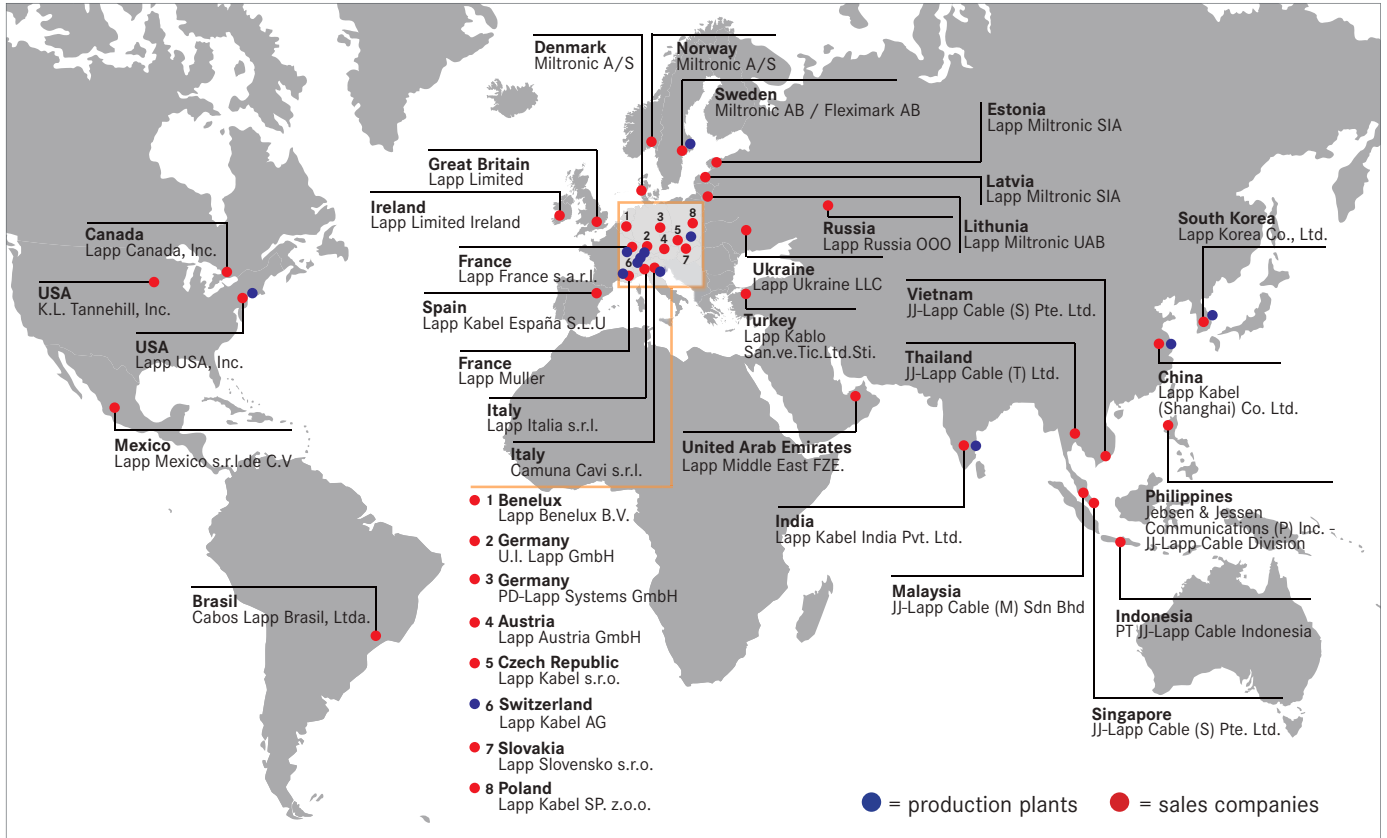

The Lapp Group around the world

The Lapp Group is an internationally active family business with headquarters in Stuttgart. Around the world, 3.000 employees in 17 production sites, 39 distribution companies and more than 100 agencies are involved in production, marketing and providing advice and service to customers.

“Think global, act local” is seen less as a slogan, but more as part of the company philosophy. After all, a strong customer focus is something we achieve all the time. This by no means contradicts our clear commitment to Stuttgart and to Germany. In addition to Germany, there are six other production sites in Europe.

With the acquisition of other business skills, the Lapp Group intends to expand its range of products and to open up new markets.

Three other production sites in Asia – with the emphasis on the boom country of India – and two in the USA support the export industry in Germany and Europe and help our customers exploit these markets.

On the one hand this provides the greatest possible proximity to customers, while on the other enables local requirements and regulations to be taken into account. Further benefits ensue, e.g. the elimination of transportation costs without having to sacrifice

the high quality reputation of “Made by Lapp”.

Lapp’s own Centers of Competence for the advanced training of employees and customers, e.g. in India, Thailand and Russia, round off our range of services.

Larger companies, such as those in Russia, India, China, Canada and Mexico, have their own warehouses. The other companies are quickly and reliably supplied from the relevant central stores.

www.lappgroup.com/worldwide

The Lapp Group worldwide



Algeria
CABELMAT EURL
14, Cité Mimouni, Lotissement 18,
Villa No. 14
16411 Bordj El Kifane
Tel.: +213 20/38 82 20
Fax: +213 20/38 82 20
info@cablemat.net



Argentina
NAKASE SRL
Calle 49 N° 5764/66
B1653A0X
Villa Ballester
1870 Buenos Aires
Tel.: +54 11/4 76 84 24 21 22
Fax: +54 11/4 76 84 24 21 11
ventas@nakase.com
www.nakase.com.ar



Armenia
AH-Building Technologies LLC
8 Tumanyan Street, Ap.3188
375002 Yerevan, ARMENIEN
Tel.: +374 10/51 91 88
Mobil: +374 91/40 04 87
Fax: +374 10/52 01 88
info@ahbt.am



Australia
DKSH Australia Pty Ltd.
14-17 Dansu Court Hallam
3803 Victoria, Australia
Tel.: +61 3/95 54 66 66
Fax: +61 3/95 54 66 88
info@dksh.com.au



Austria
Lapp Austria GmbH
Bremenstraße 8
4030 Linz
Tel.: +43 732/78 12 72
Fax: +43 732/78 12 72 33
sales@lappaustria.at
www.lappkabel.at



Azerbaijan
Ticeret Merkez - 4"
Gara Sheher 35
1025 Baku
Tel.: +994 12/4 90 65 94
Mobil: +994 5 03 55 01 02
Fax: +994 12/4 96 50 57
emil_it@office.az

Mikhail Ali-Zade
Aga-Neymatulla Str. 47A, apt. 6
1052 Baku
Tel.: +994 12/4 24 89 73
Fax: +994 12/4 49 92 70
ims.inc@azdata.net



Belarus
PNS-Professional Network Systems
Temirjaseva Str. 65a-19
220035 Minsk
Tel.: +375 17/2 50 44 21
Fax: +375 17/2 09 61 69
info@pns.by
www.pns.by



Benelux
Lapp Benelux BV
Van Dijkstraan 16, NL - 5581 WG Waalre
Postbus 74, NL - 5580 WG Waalre
Tel.: +31 (0)40/228 50 00 (NL)
Fax: +31 (0)40/228 50 10 (NL)
Tel.: +32 (0)78 35 30 60 (BE, L)
Fax: +32 (0)78 35 30 65 (BE, L)
info.lappbenelux@lappgroup.com
www.lappbenelux.com



Brazil
Cabos Lapp Brasil Ltda.
Av. Doutor Mauro Lindemberg
Monteiro, 684
Galpao 18-Osasco
CEP 06278-010 Sao Paulo
Tel.: +55 11/21 66 41 62
Fax: +55 11/21 66 41 65
vendas@lappbrasil.com.br
www.lappbrasil.com.br



Bulgaria
V & V Isomatic Ltd.
58, Dejan Belishki Str.
1404 Sofia
Tel.: +359 2/9 58 63 40
Fax: +359 2/9 58 22 70
v.v@techno-link.com
www.viv.isomatic.com



Canada
Lapp Canada Inc.
93 Skyway Avenue, Unit 111
M9W 6N6 Toronto Ontario
Tel.: +1 416/6 74 15 44
Fax: +1 416/6 74 99 50
sales@lappcanada.com
www.lappcanada.com



Chile
Desimat Chile
Av. Puerto Vespuccio 9670
Parque Industrial Puerto Santiago
Pudahuel, Santiago
Tel.: +56 2/5 85 12 00
Fax: +56 2/7 47 01 53
ventaschile@desimat.cl
www.desimat.cl



China
Lapp Group (Shanghai) Co. Ltd.
19F1 Zhaofeng Universe Building
1800 Zhongshan Road West
Shanghai PR 200233
Tel.: +86 21/64 40 08 33
Fax: +86 21/64 40 08 34
info@lappkabel.com.cn
www.lappkabel.com.cn



Colombia
Transmisiones Ltda.
Carrera 69 B No. 21 A 48
Bodega UE 28-9
Parque Industrial Salitre
Bogotá, D.C.
Tel.: +57 1/4 12 68 98
Fax: +57 1/31 53 31 52 21
info@transmisiones.de



Czech Republic
Lapp Group s.r.o.
Bartosova 315
76502 Otrokovice
Tel.: +420 573/50 10 11
Fax: +420 573/39 46 50
info@lappkabel.cz
www.lappkabel.cz



Denmark
Miltronc
Korskildeeng 6
2670 Greve
Tel.: +45 43/95 00 00
Fax: +45 43/95 00 09
info@miltronc.dk
www.miltronc.dk



Egypt
Arab Engineers Co.
113 El Thawra St., Heliopolis
Cairo
Tel.: +20 2/6 90 08 92
Fax: +20 2/4 18 71 05
cairo@arab-engineering.com
www.arab-engineering.com



Estonia
Lapp Miltronc SIA Eesti filiaali
Kastani pst. 10
44307 Rakvere
Tel.: +372 65/1 89 70
Fax: +372 65/1 89 71
info@lappmiltronc.ee
www.miltronc.ee



Finland
EPIC®
Energel Oy
Atomitie 1
00370 Helsinki
Tel.: +358 9/5 40 71 30
Fax: +358 9/54 07 13 30
energel@energel.com
www.energel.com



France
SKS Automaatio Oy
Martinkyläntie 50
P.O. Box 122
01721 Vantaa
Tel.: +358 2/07 64 61
Fax: +358 2/07 64 68 20
automaatio@sksf.fi
www.sks.fi



France
Lapp France s.a.r.l.
Technopôle Forbach-Sud
57600 Forbach
Tel.: +33 387/84 19 29
Fax: +33 387/84 17 94
lappfrance@lappgroup.com
www.lappfrance.fr



LAPP MULLER SAS
Z.A. du Grand Pont
83310 Grimaud
Tel.: +33 494/56 65 00
Fax: +33 494/4 34 87
info@mullercables.com
www.mullercables.com



Georgia
INSTA Ltd.
8, Zakariadze str.
0177 Tbilisi
Tel.: +995 322/0 20 20
Fax: +995 322/0 20 22
sales@insta.ge
www.insta.ge



Germany
U.I. Lapp GmbH
Schulze-Deitzsch-Straße 25
70565 Stuttgart
Tel.: +49 711/78 38 01
Fax: +49 711/78 38 26 40
info@lappkabel.de
www.lappgroup.com

Lapp Systems GmbH

Oskar-Lapp-Str. 5
70565 Stuttgart
Tel.: +49 711/78 38 04
Fax: +49 711/78 38 35 20
info@lappkabel.de
www.lappgroup.com

PD-Lapp Systems GmbH

Am Gewerbepark 7
01723 Wilsdruff
Tel.: +49 35204/2 05 85
Fax: +49 35204/2 04 86
info@pdlappsyste.ms.de
www.pdlappsyste.ms.de



Great Britain
Lapp Limited
Unit 3 Perivale Park
Horsenden Lane South
UB6 7RL Greenford Middlesex
Tel.: +44 20/87 58 78 00
Fax: +44 20/87 58 78 80
sales@lapplimited.com
www.lapplimited.com



Greece
Dimoulas Special Cables S.A.
100-102 Lenorman Str.
10444 Athens
Tel.: +30 21/05 15 76 10
Fax: +30 21/05 15 76 11
info@dimoulas.gr
www.dimoulas.gr



Hong Kong
Worldtex & Co.
Unit 11, 11/F, Tins Enterprises Centre
777 Lai Chi Kok Rd.
Cheung Sha Wan
Kowloon, Hong Kong
Tel.: +85 22/7 81 18 60
Fax: +85 22/7 81 47 33
info@worldtex-co.com.hk



Hungary
Lapp Austria GmbH m.k.k.
Neumann János u.1
2040 Budaörs
Tel.: +36 23 50/12 50
Fax: +36 23 50/12 59
sales@lappgroup.hu
www.lappgroup.hu



India
Lapp India Pvt. Ltd.
Plot No.98 J&K
Jigani Industrial Area
II Phase, Bangalore South- 560 105
Tel.: +91 8110-41 48 00
Fax: +91 80-27 82 54 79
custcare@lappindia.com
www.lappindia.com



Indonesia
PT. JJ-LAPP Cable Indonesia
Graha INTI FAUZI, 7th Floor,
Jl. Buncit Raya
No. 22 Jakarta 12510, Indonesia
Tel.: +62 21/27 53 70 51
Fax: +62 21/27 53 70 52
sales_jjli@jjjsea.com
www.jj-lappcable.com



Iran
Iran Technical Supply Co.
3rd Floor No. 141 Sohrevardi
Shomali Ave.
15589 Teheran
Tel.: +98 218/8 76 37 31
Fax: +98 218/8 76 95 36
info@itsco-ir.com
www.itsco-ir.com



Ireland
Lapp Limited
Unit 7, Park West Drive
Park West Business Park - Nangor
Road
Dublin 12
Tel.: +353 1/6 23 70 77
Fax: +353 1/6 23 70 78
sales@lapplimited.com
www.lapplimited.com



Iceland
Johan Rönning HF
Sundaborg 15
104 Reykjavik
Tel.: +354 5/20 08 00
Fax: +354 5/20 08 88
ronning@ronning.is
www.ronning.is



Israel
Arrow Control Cables Ltd.
7, Zavitán street
49950 Nehalim
Tel.: +972 3/9 07 48 87
Fax: +972 3/9 07 48 89
info@arrowcables.com
www.arrowcables.com



Italy
Lapp Italia s.r.l.
Via Lavoratori Autobiandhi
1-Edificio 20
20033 Desio (Milano)
Tel.: +39 036/2 48 71
Fax: +39 036/2 48 73 30
lappitalia@lappitalia.it
www.lappitalia.it



Camuna Cavi s.r.l.
Via General Treboldi, 128
25048 Edolo (BS)
Tel.: +39 036/4 77 34 11
Fax: +39 036/4 77 01 20
info@camunacavi.it
www.camunacavi.it



Japan
K.Mecs Co., Ltd.
Headquarters Yusen Iwamotocho
Bldg. 3F
2-3-3 Iwamotocho, Chiyodaku
101-0032 Tokyo
Tel.: +81 3/58 25 53 33
Fax: +81 3/58 25 85 50
info@kmecs.co.jp
www.kmecs.com



Kazakhstan
Orion Kazakhstan
Mametojov 29/41
480003 Almaty
Tel.: +7 7272/79 89 28
Fax: +7 7272/71 08 71
office@orion-light.kz

The Lapp Group worldwide

SeaStarGroup

Off-22-23. Tengri Bldg 2, Azatyk Ave.
Opp KCS Bldg
465020 Atyrau
Tel.: +7 7122/32 04 27
Fax: +7 7122/32 12 54
sales@seastar.kz
www.seastar.kz



Korea

Lapp Korea Co., Ltd.
7F, SongWon Bldg.
92-2 Yuljun JangAn
SuWonCity, KyungGi
440-824 Korea
Tel.: +82 31/2 50 10 11
Fax: +82 31/2 50 10 19



Latvia

Lapp Miltronic SIA
Brivibas iela 155
1012 RIGA
Tel.: +371 7/50 19 00
Fax: +371 7/50 19 09
info@lappmiltronic.lv
www.miltronic.lv



Libya

Owya Company
Universal shipping agency
Ahmed Rafik Street
Third Floor
LY-Benghazi
Tel.: +218 61/9 08 07 79
Fax: +218 61/9 08 07 79
owya_sp@yahoo.com



Lithuania

LAPP Miltronic UAB
P. Vileisio 18N
LT-10306 Vilnius
Tel.: +370 5/2 78 03 90
Fax: +370 5/2 78 03 97
info@lappmiltronic.lt
www.lappmiltronic.lt



Macedonia

Siskon Doeel
Taskenska 4A
1000 Skopje
Tel.: +389 2/3 06 24 23
Fax: +389 2/3 06 12 50
siskon@mt.net.mk
www.siskon.com.mk



Malaysia

JJ-LAPP Cable (M) Sdn Bhd
16, Jalan 51A/225,
46100 Petaling Jaya Selangor,
Malaysia
Tel.: +603 7/8 61 62 88
Fax: +603 7/8 61 62 99
sales_jjlm@jjsea.com
www.jj-lappcable.com



Malta

G & E Electronics Ltd.
Genics Bldgs.
Giov. Papaffy Str.
B'KARA BKR 13
Tel.: +356 21/48 68 16
Fax: +356 21/49 71 03
info@gemalta.com
www.gemalta.com



Mexico

Lapp Mexico s de rl de C.V.
Metalurgia # 2730
Industrial El Alamo C.P.
44490 Tlaquepaque, Jalisco
Tel.: +52 33/36 66 02 50
Fax: +52 33/36 66 00 75
ventas@lappmexico.com
www.lappmexico.com



Republic of Moldova

Licuri srl
Bd. Moskova, 20
2045 mun. Chisinau
Tel.: +373 2/2 49 10 12
Fax: +373 2/2 40 47 77
lurie.Gurschi@skynet.md



Mongolia

MCS International Co. Ltd.
MCS Anun centera
Khan-Uul districta
3rd khoroov
Ulaanbaatar
Tel.: +976 1/1 34 63 63
Fax: +976 1/1 34 60 30
batiko@mcs.mn
www.mcs.mn



Morocco

Lasamari
Energie & Produits S.A.R.L.
Rue Touki Ahmed No. 24
BD. HASSAN II
RESIDENCE OUROK
CASABLANCA
Tel.: +212 2226/3421 / 17
Fax: +212 2226/3421
Lep@menara.ma



New Zealand

Engineering Computer Services Ltd.
530 Te Rapa Road
P.O. Box 20204
Hamilton
Tel.: +64 7/8 49 22 11
Fax: +64 7/8 49 22 20
garry@lappgroup.co.nz
www.lappgroup.co.nz



Norway

Miltronic A/S
Eikveien 11
3036 Drammen
Tel.: +47 32/26 13 00
Fax: +47 32/2 61 39 90
info@miltronic.no
www.miltronic.no



Peru

Desimat Peru SA. C.
Av. Velasco Astete 2371
Surco-Lima 33
Tel.: +51 1/2 75 27 65
Fax: +51 1/2 75 27 76
ventas@desimat.com.pe
www.desimat.com.pe



Philippines

JJ-LAPP Cable (P) Inc
Serverina Diamond Industrial
Estate, West Service Road,
KM 16 South Expressway
1700 Paranaque City
Tel.: +632 7/86 75 66
Fax: +632 7/86 75 44
sales_jjlp@jjsea.com
www.jj-lappcable.com



Poland

Lapp Group Sp. z o.o.
ul. Wroclawska 33 D
55-095 Mirkow-Dlugoleka
Tel.: +48 71/3 30 63 00
Fax: +48 71/3 30 63 06
info@lapppolska.pl
www.lapppolska.pl



Portugal

Policabos S.A.
Soluções Técnicas de Condutores,
S.A.
Rua Maria Lamas, Lote 19 -
Bloco B - Piso 1
Parque Comercial Serra das Minas
2635-432 Rio de Mouro
Tel.: +351 21/9 17 86 40
Fax: +351 21/9 17 86 49
policabos@policabos.pt
www.policabos.pt



Rumania

Coelco Trade s.r.l.
Autostrada Bucuresti-Pitesti Km 13.5
Hala M
061076 Dragomiresti, Jud. Ilfov
Tel.: +40 21/4 11 96 21
Fax: +40 21/4 11 97 81
office@coelco.ro
www.coelco.ro



Russia

Lapp Russia OOO
Leninskaya St., 141
443041 Samara
Tel.: +7 8462/73 17 17
Fax: +7 8462/76 02 91
lapprossia@lapprossia.ru
www.lapprossia.ru



Serbia

Vesimpex d.o.o.
Petra Konjovica 12v,
Poslovni centar- Rakovica, ulaz C
11000 Beograd
Tel.: +381 11/3 51 06 83
Fax: +381 11/3 51 06 85
info@vesimpex.co.yu
www.vesimpex.co.yu



Singapore

JJ-LAPP Cable (S) Pte Ltd
No.9 Tuas South St 3
Singapore 638017
Tel.: +65 6/5 08 62 00
Fax: +65 6/8 63 12 71
sales_jjls@jjsea.com
www.jj-lappcable.com



Slovakia

Lapp Slovensko s.r.o.
Piaristicka 2
94901 Nitra
Tel.: +421 37/6 57 80 97
Fax: +421 37/6 57 80 97
info@lappkabel.sk



Slovenia

FINEA TRADE d.o.o.
Limbuška cesta 2
2000 Maribor
Tel.: +386 2/4 21 35 55
Fax: +386 2/4 21 35 71
elektro@finea-trade.si
www.finea-trade.si



South Africa

Lapp Cable SA
51 Brunton Circle
Foundersview South Modderfontein
1645 Gauteng
Tel.: +27 11/2 01 32 00
Fax: +27 11/6 09 58 50
info@lappcable.co.za
www.lappcable.co.za



Spain

Lapp Group Espana S.L.U.
Avda. de les Garrigues, 34-36,
Poligono Mas Blau II, Nave 1
08820 El Prat de Llobregat
(Barcelona)
Tel.: +34 93/4 79 62 71
Fax: +34 93/4 79 62 72
info@lappkabel.es
www.lappkabel.es



Sweden

Miltronic AB
Kungshagsvägen 7
P.O. Box 1022
61129 Nyköping
Tel.: +46 15/57 77 00
Fax: +46 15/57 77 01
info@miltronic.se
www.miltronic.se



Switzerland

Fleximark AB
Kungshagsvägen 9
P.O. Box 1022
61129 Nyköping
Tel.: +46 15/57 77 90
Fax: +46 15/57 77 91
info@fleximark.se
www.fleximark.se



Switzerland

EPIC®
Bachofen AG
Ackerstraße 42
8610 Uster
Tel.: +41 44/9 44 11 11
Fax: +41 44/9 44 12 33
info@bachofen.ch
www.bachofen.ch

Volland AG
Ifangstrasse 103
8153 Rümlang
Tel.: +41 18/17 97 97
Fax: +41 18/17 97 00
info@volland.ch
www.volland.ch



Taiwan

DKSH Taiwan Ltd
Hanover High Tech Square
10F, #22, Lane 407, Sec. 2
Ti Ding Blvd
Nei Hu District, Taipei
Tel.: +886 2/87 52 66 66
Fax: +886 2/87 51 86 88
vincent.wu@dksh.com



Thailand

JJ-LAPP Cable (T) Ltd
23/110-117 Sorachai Building
25-29th FL
Soi Sukhumvit 63 (Ekamai),
Sukhumvit Road, Klongton Nua,
Wattana, Bangkok 10110,
Thailand
Tel.: +66 2/7 87 82 88
Fax: +66 2/7 87 82 99
sales_jjlt@jjsea.com
www.jj-lappcable.com



Turkey

LAPP KABLO Sa.ve.Tic.Ltd.Sti.
Atatürk Bulvarı Ayanoglu Is
merk. No.1
34758 Atasehir-Kadiköy-Istanbul
Tel.: +90 216/4 56 56 99
Fax: +90 216/4 56 56 89
info@lapp.com.tr
www.lapp.com.tr



Ukraine

Lapp Ukraine LLC
201 - 203, Kharkivske shose
02121 Kiev
Tel.: +38 44/4 95 60 00
Fax: +38 44/4 90 76 30
info@lappukraine.com
www.lappukraine.com



United Arab Emirates

Lapp Middle East FZE
P.O.Box 18454
Dubai
Tel.: +971 4/8 86 07 44
Fax: +971 4/8 86 07 42
lappme@lappgroup.com
www.lappgroup.com



Uruguay

Reprinter Ltda.
Calle Dublin 2030
11500 Montevideo
Tel.: +598 2/6 00 73 43
Fax: +598 2/6 00 86 58
reprinter@multi.com.uy



USA

Lapp U.S.A., Inc.
29, Hanover Road
Florham Park, NJ 07932
Tel.: +1 973/6 60 97 00
Fax: +1 973/6 60 97 91
sales@lappusa.com
www.lappusa.com



USA

Lapp Tannehill, Inc.
8675 Eagle Creek Parkway Suite 900
MN55378 Savage
Tel.: +1 952/8 81 67 00
Fax: +1 952/8 81 07 43
sales@lapptannehill.com
www.kltannehill.com



Uzbekistan

Elektro-Potential LLC
2b,G.Mavlyanov str.
100084 Tashkent
Tel.: +99 898/3 00 38 21
Fax: +99 871/1 24 92 86
mz1958@yandex.ru



Venezuela

Somerinca C.A.
3era Transversal Dos Caminos
Quinta Corazon de Jesus
1070 Caracas
Tel.: +58 212/2 37 30 03
Fax: +58 212/2 39 93 41
klocmoeller@cantv.net



Vietnam

JJ-Lapp Cable (S) Pte Ltd Vietnam Rep. Office
Melinh Point Tower, Unit 906, 9th
Floor,
2 Ngo Duc Ke St, Dist.1
Ho Chi Minh City
Tel.: +84 8/4 10 34 30
Fax: +84 8/4 10 34 29
sales_jjlv@jjsea.com
www.jj-lappcable.com

You will find our actual
contact details at
www.lappgroup.com/worldwide

Lapp – The partner for wind energy worldwide

Sign of the times / Looking for partners at a global level

Wind energy plays a very important role these days. There is no other branch of industry that has recorded similar growth rates or comparable advances in its development. In the beginning the manufacturers serve the local market followed by an increasing export rising as high as 75 %. The next logical step is globalization with the establishment of own production sites in the major markets like Europe, China, India and the USA.

The development is continuing and is far from over. And wherever manufacturers and operators can be found, the Lapp Group is never far away.

As an example, Lapp's subsidiary in the USA produces market-specific cables such as the ÖLFLEX® 190 with MTW listing. These cables are the first choice for American wind turbine manufacturers.

There is no doubt that the industry will continue to change and will need to adapt to local markets. The answers to this challenge are provided by the Lapp Group every day, as a global player in more than 120 countries. Benefit from this expertise and choose a global specialist with local knowledge to ensure the cost reducing product choice on a global level. Talk to us – Cost is about more than just the price.



Source: PowerWind GmbH



Lapp RFID – New product highlights by Lapp

The latest innovation from Lapp Kabel is ready for launch under the motto „Lapp products learn how to talk“. Lapp Kabel has combined

its cable and connector technology with an RFID system.

What is RFID?

RFID stands for „Radio Frequency Identification“. This technology uses radio waves to transfer data. The scanner does not have to contact the RFID tag and tags can still be read even if they are beyond the line of sight of the scanner.

In its most basic form, an RFID system consists of at least 3 components:

- Transponder
- Reader/Scanner
- IT system

The word „transponder“ is made up from the words „trans(mitter)“ and „(res)ponder“. The transponder is the component which actually holds the data in the RFID system. It consists of an antenna, a microchip and a housing. It is designed to accept and store data or to allow data to be read out from it.

The writing/reading device is often combined in one unit. It can be a handheld device, a mobile phone or a device specially developed for RFID technology. These devices are used to write data to the transponder or read out data from it.

The IT system allows the data to be processed and, for example, incorporated into an inventory management system.

RFID is often compared to barcode technology, which has been in use for many years. In actual fact, RFID has some important advantages compared to barcode technology:

Non-contact data reading beyond the line of sight

Since RFID is based on radio technology, data can be transferred without the need for the scanner to contact the tag. RFID tags can still be read even if they are beyond the line of sight of the scanner, unlike barcodes.

Simultaneous reading and writing of data

A barcode system requires a database which supplies the relevant data. This means that a connection to the corresponding database is always required to identify a barcode. With an RFID transponder, identification data can be stored on the chip itself. This data is thus definitively assigned to the product.

Resistant to external influences

External influences such as dirt or moisture have no effect on RFID transponders. Barcodes may however be rendered illegible and thus unusable in similar circumstances.

Bulk scanning

RFID allows multiple transponders to be scanned in one operation.

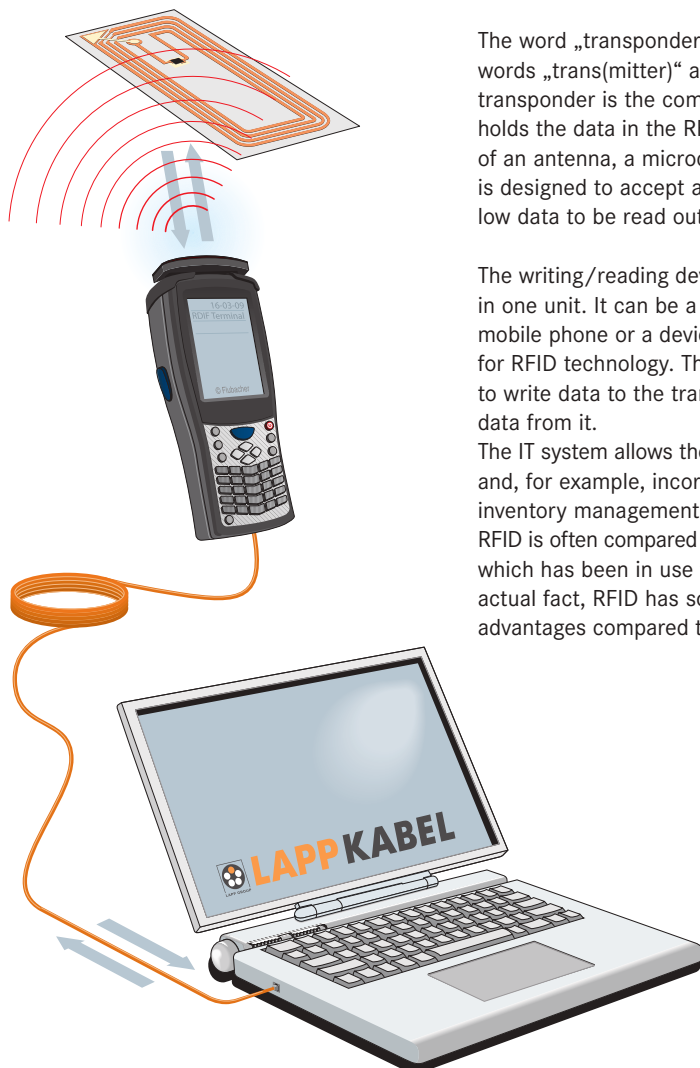

Lapp products learn how to talk

Cables and connectors with RFID

All of the aforementioned advantages of RFID have now been combined with high-quality products from Lapp Kabel. RFID chips and RFID sensors are integrated into the cable and connector during production. This has no effect on the high flexibility and physical durability of the components. This innovation allows the cables and connectors to be used for new applications, especially in the field of light and sound engineering:

Identification

It is often the case that several companies are contracted to work on setting up the same event. Whereas one company will be responsible for ensuring sound quality, another company will be in charge of the lighting. Naturally, the companies sometimes use the same infrastructure. Cables and connectors are often disassembled and then reassembled elsewhere, making it hard to keep track of them. RFID offers a solution to this problem by definitively identifying all of the components. An RFID chip is used to identify the company the component belongs to, preventing any mix-ups.

Inventory management

Due to the large quantities of cables and connectors in use, a lot of effort is put into handling these products. By connecting the products to an inventory management system using modern RFID technology, inventory management processes can be optimised significantly. The potential for manual data entry errors is minimised considerably, which in turn reduces process costs.

Storage of measurement logs

The law requires regular checking of cables and connectors used for mobile power supply applications. Since RFID transponders can store data and are rewritable, they can be used to store measurement logs i.e. the latest measurement logs can be stored directly on the component that has been checked. This allows the data to be accessed at any time and place as required.

Temperature and moisture measurement

Along with RFID chips, Lapp has also developed RFID sensors which can be integrated into a cable. These sensors can be used to monitor certain aspects of a cable. These include, for example, temperature and moisture measurement.

Lapp is delighted to help you innovate for success with RFID. Our consulting engineers are available to discuss your initial requirements.



ÖLFLEX®

Power- and control cables

ÖLFLEX® control and data cables have been used world wide for 50 years. They have also been used from the very beginning in the wind industry. Over the last 30 years more than 140 types of ÖLFLEX® control and data cables have been used in wind turbines. In the current catalog you will find the ones that are used in substantial quantities.

Today Lapp offers a ranges control and data cables including cold flexible, bending, torsion resistant and halogen-free cables for the wind industry.

Many of the products from Lapp's standard range have already proved their worth in wind energy. For example, the ÖLFLEX® CLASSIC 110 has been in continuous use in the drip loop for more than 10 years. The high quality that Lapp demands from all its products meant that it has withstood the extreme requirements in the drip loop until this very day and is still doing its job.

New in the range:

ÖLFLEX® TORSION FRNC – the cold, torsion and oil resistant with optimum fire properties and certification for North America. It is ideal for high flexibility applications in the loop in wind turbines. This is one of the easiest cables to assemble for torsional loads on the market thanks to its easy insulation stripping.

Fast and easy assembly and installation = Lower costs.



ÖLFLEX® CLASSIC 100



Info

- Customised colour option and printing of the outer sheath on request



Benefits

- Space saving installation due to small cable diameters
- High electrical performance due to 4kV test voltage
- Increased flexibility due short-twisted conductor layers

Application range

- Plant engineering and construction
Industrial machinery
Air conditioning installations
Power station
- Dry or damp interiors under medium mechanical load conditions
- Fixed installation as well as occasional flexing at free, non-continuously recurring movement without tensile load

Product features

- Flame retardant according to IEC 60332-1-2
- Good chemical resistance see Appendix T1

Approvals (Norm references)



Design

- Fine strands of bare copper wires
- PVC insulation LAPP P8/1
- Cores twisted in layers
- PVC outer sheath, grey (RAL 7001)

Technical data

- Core identification code**
Up to 5 cores: According to VDE 0293-308 Appendix T9)
Starting at 6 cores: ÖLFLEX® colour code see Appendix T 7
- Based on**
IEC 60227-5
HD 21.5 S3; VDE 0281 Part 5
HD 21.13 S1; VDE 0281 Part 13
- Specific insulation resistance**
> 20 GOhm x cm
- Conductor stranding**
Fine wire in accordance to VDE 0295 Class 5 / IEC 60228 Class 5
- Minimum bending radius**
Occasional flexing: 15 x cable diameter
Fixed installation: 4 x cable diameter
- Rated voltage**
Up to 1.5 mm²: U0/U: 300/500 V
Starting at 2.5 mm²: U0/U: 450/750 V
Fixed, protected installation:
U0/U: 600/1000 V
- Test voltage**
4000 V
- Protective conductor**
G = with protective conductor GN/YE
X = without protective conductor
- Range of temperature**
Occasional flexing: -5°C up to +70°C
Fixed installation: -40°C up to +80°C

Part number	Number of cores and mm² per conductor	Outer diameter in mm approx.	Copper index kg/km	Weight kg/km approx.
ÖLFLEX® CLASSIC 100; U0/U: 300/500 V				
0010000	2 X 0.5	5.4	9.6	42
0010001	3 G 0.5	5.7	14.4	50
00101223	3 X 0.5	5.7	15.0	50
00100023	4 G 0.5	6.2	19.2	60
00101233	4 X 0.5	6.2	19.2	60
00100033	5 G 0.5	6.7	24.0	71
00101243	5 X 0.5	6.7	24.0	71
0010004	6 G 0.5	6.7	29.0	73
0010005	7 G 0.5	6.7	33.6	81
0010006	8 G 0.5	8.0	38.4	97
0010007	10 G 0.5	8.6	48.0	116
0010008	12 G 0.5	8.9	58.0	133
0010009	14 G 0.5	9.5	67.0	151
0010010	16 G 0.5	10.0	76.0	169
0010011	21 G 0.5	11.7	99.0	223
0010012	24 G 0.5	12.4	114.0	254
0010016	40 G 0.5	15.4	192.0	404
0010021	2 X 0.75	6.2	14.4	56
0010022	3 G 0.75	6.5	21.6	67
00101253	3 X 0.75	6.5	21.6	67
00100233	4 G 0.75	7.1	28.8	81
00101263	4 X 0.75	7.1	28.8	81
00100243	5 G 0.75	8.0	36.0	99
00101273	5 X 0.75	8.0	36.0	99
0010025	6 G 0.75	7.3	43.3	104
0010026	7 G 0.75	7.3	50.4	109
0010027	8 G 0.75	8.8	56.0	123
0010028	9 G 0.75	9.4	63.0	144
0010029	10 G 0.75	9.6	72.0	153
0010030	12 G 0.75	9.9	86.4	176
0010031	15 G 0.75	10.9	108.0	229
0010032	18 G 0.75	11.7	129.6	268
0010033	21 G 0.75	13.0	151.0	293
0010034	25 G 0.75	13.8	180.0	374
0010036	40 G 0.75	17.3	288.0	571
0010037	50 G 0.75	19.2	360.0	698
0010041	2 X 1	6.5	19.2	64
0010042	3 G 1	6.9	29.0	78



Wide range use

PVC sheath and coloured cores

Part number	Number of cores and mm ² per conductor	Outer diameter in mm approx.	Copper index kg/km	Weight kg/km approx.
00102033	3 X 1	6.9	28.0	78
00100433	4 G 1	7.7	38.4	97
00102043	4 X 1	7.7	38.4	97
00100443	5 G 1	8.4	48.0	105
00102053	5 X 1	8.4	48.0	105
0010045	6 G 1	8.0	58.0	124
0010046	7 G 1	8.0	67.0	131
0010047	8 G 1	9.5	77.0	146
0010049	10 G 1	10.2	96.0	183
0010050	12 G 1	10.5	115.0	220
0010052	16 G 1	11.8	154.0	282
0010053	18 G 1	12.7	173.0	315
0010054	20 G 1	13.4	192.0	350
0010056	25 G 1	14.7	240.0	449
0010063	2 X 1.5	7.5	29.0	87
0010064	3 G 1.5	8.1	43.0	109
00101283	3 X 1.5	8.1	43.0	109
00100653	4 G 1.5	8.9	58.0	133
00101293	4 X 1.5	8.9	58.0	133
00100663	5 G 1.5	10.0	72.0	163
00101303	5 X 1.5	10.0	72.0	163
0010068	7 G 1.5	8.9	101.0	166
0010069	8 G 1.5	10.6	115.0	205
0010071	12 G 1.5	12.0	173.0	307
0010072	14 G 1.5	12.7	202.0	349
0010074	18 G 1.5	14.4	259.0	465
0010076	25 G 1.5	16.9	360.0	655
ÖLFLEX® CLASSIC 100; U0/U: 450/750 V				
0010086	2 X 2.5	8.9	48.0	128
0010087	3 G 2.5	9.6	72.0	162
00100933	3 X 2.5	9.6	72.0	162
00100883	4 G 2.5	10.7	96.0	203
00100893	5 G 2.5	11.8	120.0	242
0010091	7 G 2.5	13.1	168.0	321
0010092	8 G 2.5	15.8	192.0	385
0010100	2 X 4	10.6	76.8	187
0010210	3 G 4	11.8	115.2	255
00101013	4 G 4	12.7	154.0	297
00101023	5 G 4	13.9	192.0	355
0010103	7 G 4	15.4	269.0	471
0010105	3 G 6	12.6	173.0	318
00101063	4 G 6	13.8	230.0	394
00101073	5 G 6	15.6	288.0	489
0010108	7 G 6	17.3	403.0	651
0010301	3 G 10	15.9	288.0	516
00101093	4 G 10	17.6	384.0	650
00101103	5 G 10	19.7	480.0	792
0010111	7 G 10	21.7	672.0	1,058
0010302	3 G 16	18.3	461.0	911
00101123	4 G 16	20.4	614.0	1,087
00101133	5 G 16	22.8	768.0	1,370
0010303	3 G 25	23.0	720.0	1,388
00101153	4 G 25	25.4	960.0	1,582
00101163	5 G 25	28.5	1,200.0	1,998
0010304	3 G 35	25.6	1,008.0	1,766
00101173	4 G 35	28.5	1,344.0	2,106
00101183	5 G 35	31.9	1,680.0	2,635
0010305	3 G 50	31.0	1,440.0	2,556
00101193	4 G 50	34.5	1,920.0	2,943
00103133	5 G 50	38.6	2,400.0	3,936
0010306	3 G 70	35.3	2,016.0	3,182
00101203	4 G 70	39.4	2,688.0	4,092
00103143	5 G 70	44.1	3,360.0	4,800
0010307	3 G 95	41.3	2,736.0	4,675
00101213	4 G 95	45.8	3,648.0	5,538
00103153	5 G 95	50.0	4,560.0	5,600
0010308	3 G 120	46.6	3,456.0	5,626
00103093	4 G 120	51.9	4,608.0	6,994
00103123	4 G 185	61.9	7,104.0	8,300

Copper price basis: EUR 150 / 100 kg

Please find our standard lengths at: www.lappkabel.de/en/cable-standardlengths

Packaging size: Coil ≤ 30 kg and ≤ 250 m, otherwise drum

Please specify the desired packaging size (e.g. 1 x 500 m drum or 5 x 100 m coils)

Single lengths for sizes: ≥ 5G50 max. 500m; ≥ 5G95 max. 400; ≥ 3G120 max. 500m; ≥ 4G120 max. 300; ≥ 4G185 max. 250m

■ Comparable products

- UNITRONIC® 100
- ÖLFLEX® CLASSIC 100 BK POWER 0,6/1kV see page 16
- ÖLFLEX® CLASSIC 130 H BK 0,6/1kV see page 29

■ Accessories

- SKINTOP® CLICK see page 109
- TY - FAST® standard cable ties
- STAR STRIP stripping tool

ÖLFLEX® CLASSIC 100 CY



Info

- EMC compliant



Benefits

- Space saving installation due to small cable diameters
- High electrical performance due to 4kV test voltage

Application range

- Plant engineering and construction
Industrial machinery
Air conditioning installations
- Conveying and transport systems
- Servo drives
- In EMI critical environment (electromagnetic interference)

Product features

- Flame retardant according to IEC 60332-1-2

- Good chemical resistance see Appendix T1
- High coverage degree of the screen low transfer impedance (max. 250 Ω/km at 30 MHz)

Approvals (Norm references)



Design

- Fine strands of bare copper wires
- PVC insulation LAPP P8/1
- PVC inner sheath, grey
- Screen made of tinned copper wire braid
- PVC outer sheath, transparent

Technical data



Core identification code
Up to 5 cores: According to VDE 0293-308 Appendix T9)
Starting at 6 cores: ÖLFLEX® colour code see Appendix T7



Based on
IEC 60227-5
HD 21.5 S3; VDE 0281 Part 5
HD 21.13 S1; VDE 0281 Part 13



Specific insulation resistance
> 20 GΩm x cm



Conductor stranding
Fine wire in accordance to VDE 0295 Class 5 / IEC 60228 Class 5



Minimum bending radius
Occasional flexing: 20 x cable diameter
Fixed installation: 6 x cable diameter



Rated voltage
Up to 1.0 mm²: U0/U: 300/500 V
Starting at 1.5 mm²: U0/U: 450/750 V
Fixed, protected installation:
U0/U: 600/1000 V



Test voltage
4000 V



Protective conductor
G = with protective conductor GN/YE
X = without protective conductor



Range of temperature
Occasional flexing: -5°C up to +70°C
Fixed installation: -40°C up to +80°C

Part number	Number of cores and mm² per conductor	Outer diameter in mm approx.	Copper index kg/km	Weight kg/km approx.
ÖLFLEX® CLASSIC 100 CY; U0/U: 300/500 V				
0035001	2 X 0.5	7.0	41.0	75
0035002	3 G 0.5	7.3	46.0	83
00350033	4 G 0.5	7.9	55.0	99
00352013	5 G 0.5	8.4	66.0	112
0035202	7 G 0.5	8.9	80.0	132
0035004	2 X 0.75	7.4	46.0	86
0035005	3 G 0.75	7.9	57.0	100
00350063	4 G 0.75	8.4	64.0	115
00350163	5 G 0.75	8.9	77.0	130
0035203	7 G 0.75	9.7	102.0	161
0035220	2 X 1	7.9	56.0	98
0035221	3 G 1	8.2	65.0	111
00352223	4 G 1	8.7	78.0	130
00352233	5 G 1	9.5	89.0	153
0035204	7 G 1	10.2	113.0	185
ÖLFLEX® CLASSIC 100 CY; U0/U: 450/750 V				
0035000	2 X 1.5	9.9	65.0	132
0035458	3 G 1.5	10.3	79.0	170
00354593	4 G 1.5	11.3	97.0	204
00354603	5 G 1.5	12.6	116.0	246
0035461	7 G 1.5	13.9	149.0	320
0035011	3 G 2.5	11.8	146.0	211
00350173	4 G 2.5	13.5	167.0	310
00350123	5 G 2.5	14.6	200.0	326

Part number	Number of cores and mm² per conductor	Outer diameter in mm approx.	Copper index kg/km	Weight kg/km approx.
0035289	7 G 2.5	15.9	288.0	444
00350183	4 G 4	15.1	237.0	403
00350133	5 G 4	16.5	328.0	478
00350193	4 G 6	16.6	318.0	524
00350143	5 G 6	18.2	441.0	624
0034953	3 G 10	18.9	414.0	690
00350213	4 G 10	21.1	558.0	843
00352903	5 G 10	23.1	714.0	1,004
0034954	3 G 16	21.7	607.0	910
00350223	4 G 16	23.9	804.0	1,395
00350153	5 G 16	26.8	1,050.0	1,812
0034955	3 G 25	26.6	936.0	1,330
00350233	4 G 25	29.4	1,289.0	1,903
00350243	5 G 25	32.6	1,446.0	2,374
0034956	3 G 35	29.4	1,258.0	1,370
00350253	4 G 35	32.4	1,693.0	2,489
00350263	5 G 35	36.0	1,975.0	2,771
0034952	3 G 50	35.1	1,748.0	2,590
00350273	4 G 50	38.8	2,342.0	3,362
00350283	4 G 70	43.7	3,035.0	3,719
00350293	4 G 95	50.4	4,055.0	5,849
00354303	4 G 120	56.8	5,225.0	7,509
00354313	4 G 150	62.2	6,300.0	7,800
00354323	4 G 185	67.8	7,753.0	9,866

Copper price basis: EUR 150 / 100 kg
Please find our standard lengths at: www.lappkabel.de/en/cable-standardlengths
Packaging size: Coil ≤ 30 kg and ≤ 250 m, otherwise drum
Please specify the desired packaging size (e.g. 1 x 500 m drum or 5 x 100 m coils)
Single lengths for sizes: ≥ 4G50 max. 500m; ≥ 4G95 max. 400m; ≥ 4G120 max. 300m; ≥ 4G150 max. 250m

Comparable products

- ÖLFLEX® SERVO 9YSLCY-JB UL/CSA
- ÖLFLEX® SERVO 2YSLCY-JB

Accessories

- 3M Scotch 1183 screening tape
- SKINTOP® MS-SC-M BRUSH see page 115

Wide range use

PVC sheath and coloured cores

ÖLFLEX® CLASSIC 100 BK POWER 0,6/1kV



Info

- Down to -30°C

Benefits

- Space saving installation due to small cable diameters
- High electrical performance due to 4kV test voltage

Application range

- Plant engineering and construction
Industrial machinery
Air conditioning installations
Paint-spray lines
- Stage technology
- Fixed installation as well as occasional flexing at free, non-continuously recurring movement without tensile load
- Outdoor use suitable considering the temperature range

- Suitable for direct burial

Product features

- Flame retardant according to IEC 60332-1-2
- UV resistant and weather proof
- Flexible down to -30°C

Approvals (Norm references)



Design

- Fine strands of bare copper wires
- Core insulation: PVC, cold-resistant
- PVC outer sheath, cold-resistant, black (RAL 9005)

Technical data

- Core identification code**
Up to 5 cores: According to VDE 0293-308 Appendix T9)
Starting at 6 cores: ÖLFLEX® colour code see Appendix T 7
- Specific insulation resistance**
> 20 GOhm x cm
- Conductor stranding**
Fine wire in accordance to VDE 0295 Class 5 / IEC 60228 Class 5
- Minimum bending radius**
Occasional flexing: 15 x cable diameter
Fixed installation: 4 x cable diameter
- Rated voltage**
U_i/U: 600/1000 V
- Test voltage**
4000 V
- Protective conductor**
G = with protective conductor GN/YE
X = without protective conductor
- Range of temperature**
Occasional flexing: -30°C up to +70°C
Fixed installation: -40°C up to +80°C

Part number	Number of cores and mm ² per conductor	Outer diameter in mm approx.	Copper index kg/km	Weight kg/km approx.
ÖLFLEX® CLASSIC 100 BK POWER 0,6/1 kV				
1120450	2 X 0.5	7.9	9.6	56
1120451	3 G 0.5	8.2	14.4	68
1120452	4 G 0.5	8.8	19.2	100
1120453	5 G 0.5	9.4	24.0	117
1120454	7 G 0.5	10.1	34.0	138
1120455	12 G 0.5	12.5	58.0	200
1120456	2 X 1	8.6	19.2	98
1120457	3 G 1	9.0	29.0	112
1120458	4 G 1	9.6	38.0	131
1120459	5 G 1	10.4	48.0	152
1120460	7 G 1	11.1	67.0	196
1120461	12 G 1	14.0	115.0	286
1120462	2 X 1.5	9.6	29.0	123
1120463	3 G 1.5	10.1	43.0	144
1120464	4 G 1.5	10.8	58.0	170
1120465	5 G 1.5	11.7	72.0	199
1120466	7 G 1.5	12.6	101.0	261
1120467	12 G 1.5	16.1	173.0	399
1120468	2 X 2.5	10.8	48.8	147
1120469	3 G 2.5	11.3	72.0	182
1120470	4 G 2.5	12.2	96.0	225
1120471	5 G 2.5	13.3	120.0	266
1120472	7 G 2.5	14.4	168.0	354
1120473	12 G 2.5	18.7	288.0	540
1120474	4 G 4	13.8	154.0	324
1120475	4 G 6	15.1	230.0	442
1120476	4 G 10	18.7	384.0	707
1120477	4 G 16	21.3	614.0	1,100
1120478	4 G 25	26.2	960.0	1,600
1120479	4 G 35	29.1	1,344.0	2,400
1120480	4 G 50	35.6	1,920.0	3,400
1120481	4 G 70	40.7	2,688.0	5,050
1120482	4 G 95	46.8	3,648.0	6,010
1120483	4 G 120	53.5	4,608.0	7,500

Copper price basis: EUR 150 / 100 kg
 Please find our standard lengths at: www.lappkabel.de/en/cable-standardlengths
 Packaging size: Coil ≤ 30 kg and ≤ 250 m, otherwise drum
 Please specify the desired packaging size (e.g. 1 x 500 m drum or 5 x 100 m coils)
 Further sizes as well as screened types on request

Comparable products

- ÖLFLEX® CLASSIC 130 H BK 0,6/1kV see page 29
- ÖLFLEX® CLASSIC 110 BLACK 0,6/1kV see page 20

Accessories

- Stainless steel - Box Starter - Set
- SKINTOP® MS-M see page 113

ÖLFLEX® CLASSIC 110



Info

- **Change to an improved version:**
 - without talcum
 - additional meter marking



Benefits

- Space saving installation due to small cable diameters
- High electrical performance due to 4kV test voltage

Application range

- Plant engineering and construction
 - Industrial machinery
 - Air conditioning installations
 - Power station
 - Stage technique
- Fixed installation as well as occasional flexing at free, non-continuously recurring movement without tensile load
- Dry or damp interiors under medium mechanical load conditions

Product features

- Flame retardant according to IEC 60332-1-2
- Good chemical resistance see Appendix T1

Approvals (Norm references)



Design

- Fine strands of bare copper wires
- PVC insulation LAPP P8/1
- Cores twisted in layers
- PVC outer sheath, grey (RAL 7001)

Technical data

- Core identification code**
Black with white numbers acc. to VDE 0293
- Specific insulation resistance**
> 20 GOhm x cm
- Conductor stranding**
Fine wire in accordance to VDE 0295 Class 5 / IEC 60228 Class 5
- Minimum bending radius**
Occasional flexing: 15 x cable diameter
Fixed installation: 4 x cable diameter
- Rated voltage**
U₀/U: 300/500 V
- Test voltage**
4000 V
- Protective conductor**
G = with protective conductor GN/YE
X = without protective conductor
- Range of temperature**
Occasional flexing: -5°C up to +70°C
Fixed installation: -40°C up to +80°C
- VDE tested**
VDE Reg. No. 7030 for sizes up to and including 60 cores

Part number	Number of cores and mm ² per conductor	Available as standard length only (*)	Standard lengths, meter							Outer diameter in mm approx.	Copper index kg/km	Weight kg/km approx.
			25	50	100	200	300	500	1000			
ÖLFLEX® CLASSIC 110; U₀/U: 300/500 V												
1119752	2 X 0.5	•			100	200	300	500	1000	4.8	9.6	35
1119003	3 G 0.5	•			100	200	300	500	1000	5.1	14.4	42
1119753	3 X 0.5	•			100	200	300	500	1000	5.1	14.4	42
1119004	4 G 0.5	•			100	200	300	500	1000	5.7	19.2	54
1119754	4 X 0.5	•			100	200	300	500	1000	5.7	19.2	54
1119005	5 G 0.5	•			100	200	300	500	1000	6.2	24.0	63
1119755	5 X 0.5	•			100	200	300	500	1000	6.2	24.0	63
1119007	7 G 0.5	•		50	100	200	300	500	1000	6.7	33.6	81
1119757	7 X 0.5	•		50	100	200	300	500	1000	6.7	33.6	81
1119010	10 G 0.5	•		50	100	200	300	500	1000	8.6	48.0	116
1119012	12 G 0.5	•		50	100	200	300	500	1000	8.9	58.0	131
1119014	14 G 0.5	•		50	100			500	1000	9.5	67.0	153
1119018	18 G 0.5	•		50	100			500	1000	10.5	86.4	188
1119021	21 G 0.5	•		50	100			500	1000	11.7	101.0	221
1119025	25 G 0.5	•		50	100			500	1000	12.4	120.0	261
1119030	30 G 0.5	•		50	100			500	1000	13.3	144.0	304
1119035	35 G 0.5	•		50	100			500	1000	14.5	168.0	256
1119040	40 G 0.5	•		50	100			500	1000	15.4	192.0	400
1119052	52 G 0.5	•		50	100			500		17.3	250.0	517
1119061	61 G 0.5	•		50	100			500		18.5	293.0	603
1119065	65 G 0.5	•		50	100			500		19.6	312.0	644
1119080	80 G 0.5	•		50	100			500		21.1	384.0	780
1119100	100 G 0.5	•		50	100			500		23.6	480.0	975
1119802	2 X 0.75	•			100	200	300	500	1000	5.4	14.4	45
1119103	3 G 0.75	•			100	200	300	500	1000	5.7	21.6	55
1119803	3 X 0.75	•			100	200	300	500	1000	5.7	21.6	55
1119104	4 G 0.75	•			100	200	300	500	1000	6.2	28.8	66
1119804	4 X 0.75	•			100	200	300	500	1000	6.2	28.8	66
1119105	5 G 0.75	•		50	100	200	300	500	1000	6.7	36.0	79
1119805	5 X 0.75	•		50	100	200	300	500	1000	6.7	36.0	79
1119107	7 G 0.75	•		50	100	200	300	500	1000	7.3	50.0	101
1119807	7 X 0.75	•		50	100	200	300	500	1000	7.3	50.0	101
1119109	9 G 0.75	•		50	100	200	300	500	1000	9.4	65.0	137
1119110	10 G 0.75	•		50	100	200	300	500	1000	9.6	72.0	150
1119112	12 G 0.75	•		50	100	200	300	500	1000	9.9	86.0	171
1119812	12 X 0.75	•		50	100	200	300	500	1000	9.9	86.0	171
1119115	15 G 0.75	•		50	100			500	1000	10.9	108.0	209
1119117	15 X 0.75	•		50	100			500	1000	10.9	108.0	209
1119116	16 G 0.75	•		50	100			500	1000	11.1	115.2	220
1119118	18 G 0.75	•		50	100			500	1000	11.7	130.0	244
1119121	21 G 0.75	•		50	100			500	1000	13.0	151.0	286
1119125	25 G 0.75	•		50	100			500	1000	13.8	180.0	337
1119126	26 G 0.75	•		50	100			500	1000	14.2	187.2	350
1119134	34 G 0.75	•		50	100			500	1000	15.9	245.0	448
1119141	41 G 0.75	•		50	100			500	1000	17.4	296.0	538
1119150	50 G 0.75	•		50	100			500		19.2	360.0	648
1119151	51 G 0.75	•		50	100			500		19.2	367.0	646
1119161	61 G 0.75	•		50	100			500		20.5	439.0	779
1119165	65 G 0.75	•		50	100			500		21.8	468.0	832
1119180	80 G 0.75	•		50	100			500		23.6	576.0	1,019
1119200	100 G 0.75	•		50	100			500		26.4	718.0	1,271
1119852	2 X 1	•			100	200	300	500	1000	5.7	19.2	53
1119203	3 G 1	•			100	200	300	500	1000	6.0	28.8	65



Wide range use

PVC sheath and numbered cores

Part number	Number of cores and mm ² per conductor	Available as standard length only (*)	Standard lengths, meter						Outer diameter in mm approx.	Copper index kg/km	Weight kg/km approx.	
			25	50	100	200	300	500				1000
1119853	3 X 1	•			100	200	300	500	1000	6.0	28.8	65
1119204	4 G 1	•		50	100	200	300	500	1000	6.5	38.4	79
1119854	4 X 1	•		50	100	200	300	500	1000	6.5	38.4	79
1119205	5 G 1	•		50	100	200	300	500	1000	7.1	48.0	94
1119855	5 X 1	•		50	100	200	300	500	1000	7.1	48.0	94
1119206	6 G 1	•		50	100	200	300	500	1000	8.0	58.0	113
1119207	7 G 1	•		50	100	200	300	500	1000	8.0	67.0	126
1119857	7 X 1	•		50	100	200	300	500	1000	8.0	67.0	126
1119208	8 G 1	•		50	100	200	300	500	1000	9.5	77.0	149
1119209	9 G 1	•		50	100	200	300	500	1000	10.0	86.0	164
1119210	10 G 1	•		50	100	200	300	500	1000	10.2	96.0	180
1119212	12 G 1	•		50	100	200	300	500	1000	10.5	115.0	205
1119862	12 X 1	•		50	100	200	300	500	1000	10.5	115.0	205
1119214	14 G 1	•		50	100			500	1000	11.2	134.0	238
1119216	16 G 1	•		50	100			500	1000	11.8	153.6	266
1119218	18 G 1	•		50	100			500	1000	12.7	173.0	320
1119868	18 X 1	•		50	100			500	1000	12.7	173.0	320
1119220	20 G 1	•		50	100			500	1000	13.4	192.0	330
1119870	20 X 1	•		50	100			500	1000	13.4	192.0	330
1119225	25 G 1	•		50	100			500	1000	14.7	240.0	408
1119226	26 G 1	•		50	100			500	1000	15.1	249.0	424
1119234	34 G 1	•		50	100			500	1000	17.1	326.0	551
1119236	36 G 1	•		50	100			500	1000	17.4	346.0	578
1119241	41 G 1	•		50	100			500	1000	18.8	394.0	661
1119242	42 G 1	•		50	100			500	1000	19.1	403.2	695
1119250	50 G 1	•		50	100			500		20.6	480.0	797
1119256	56 G 1	•		50	100			500		21.4	538.0	888
1119261	61 G 1	•		50	100			500		22.1	586.0	958
1119265	65 G 1	•		50	100			500		23.6	624.0	1,033
1119280	80 G 1	•		50	100			500		25.3	768.0	1,251
1119300	100 G 1	•		50	100			500		28.3	960.0	1,560
1119902	2 X 1.5	•			100	200	300	500	1000	6.3	29.0	68
1119303	3 G 1.5	•	25	50	100	200	300	500	1000	6.7	43.0	84
1119903	3 X 1.5	•		50	100	200	300	500	1000	6.7	43.0	84
1119304	4 G 1.5	•	25	50	100	200	300	500	1000	7.2	58.0	104
1119904	4 X 1.5	•		50	100	200	300	500	1000	7.2	58.0	104
1119305	5 G 1.5	•	25	50	100	200	300	500	1000	8.1	72.0	128
1119905	5 X 1.5	•		50	100	200	300	500	1000	8.1	72.0	128
1119306	6 G 1.5	•		50	100	200	300	500	1000	8.4	86.4	157
1119307	7 G 1.5	•	25	50	100	200	300	500	1000	8.9	101.0	166
1119907	7 X 1.5	•		50	100	200	300	500	1000	8.9	101.0	166
1119308	8 G 1.5	•		50	100			500	1000	10.6	115.0	210
1119313	8 X 1.5	•		50	100			500	1000	10.6	115.0	210
1119309	9 G 1.5	•		50	100			500	1000	11.4	130.0	221
1119310	10 G 1.5	•		50	100			500	1000	11.6	143.0	243
1119311	11 G 1.5	•		50	100			500	1000	11.6	158.0	258
1119312	12 G 1.5	•	25	50	100			500	1000	12.0	173.0	279
1119912	12 X 1.5	•		50	100			500	1000	12.0	173.0	279
1119314	14 G 1.5	•		50	100			500	1000	12.7	202.0	323
1119316	16 G 1.5	•		50	100			500	1000	13.4	230.4	361
1119318	18 G 1.5	•	25	50	100			500	1000	14.4	259.0	407
1119321	21 G 1.5	•		50	100			500	1000	15.7	302.0	469
1119325	25 G 1.5	•	25	50	100			500	1000	16.9	360.0	560
1119326	26 G 1.5	•		50	100			500	1000	17.3	374.4	582
1119332	32 G 1.5	•		50	100			500	1000	18.7	461.0	704
1119334	34 G 1.5	•		50	100			500	1000	19.4	490.0	746
1119341	41 G 1.5	•		50	100			500	1000	21.3	591.0	895
1119350	50 G 1.5	•		50	100			500		23.5	720.0	1,089
1119361	61 G 1.5	•		50	100			500		25.2	878.0	1,309
1119365	65 G 1.5	•		50	100			500		26.7	936.0	1,398
1119952	2 X 2.5	•	25	50	100	200	300	500	1000	7.5	48.0	101
1119403	3 G 2.5	•	25	50	100	200	300	500	1000	8.1	72.0	132
1119404	4 G 2.5	•	25	50	100	200	300	500	1000	8.9	96.0	163
1119405	5 G 2.5	•	25	50	100	200	300	500	1000	10.0	120.0	200
1119407	7 G 2.5	•	25	50	100			500	1000	11.1	168.0	267
1119412	12 G 2.5	•	25	50	100			500	1000	14.8	288.0	445
1119414	14 G 2.5	•		50	100			500	1000	15.8	336.0	515
1119418	18 G 2.5	•	25	50	100			500	1000	17.8	432.0	648
1119425	25 G 2.5	•	25	50	100			500	1000	20.8	600.0	890
1119434	34 G 2.5	•		50	100			500	1000	24.4	816.0	1,208
1119450	50 G 2.5	•		50	100			500		29.4	1,200.0	1,754
1119503	3 G 4	•	25	50	100			500	1000	9.9	115.0	201
1119504	4 G 4	•	25	50	100			500	1000	10.8	154.0	249
1119505	5 G 4	•	25	50	100			500	1000	12.1	192.0	294
1119507	7 G 4	•	25	50	100			500	1000	13.4	269.0	407
1119511	11 G 4	•		50	100			500	1000	17.6	422.0	634
1119512	12 G 4	•		50	100			500	1000	18.1	461.0	660
1119603	3 G 6	•	25	50	100			500	1000	11.7	172.8	289
1119604	4 G 6	•	25	50	100			500	1000	13.0	230.0	365
1119605	5 G 6	•	25	50	100			500	1000	14.5	288.0	447
1119607	7 G 6	•	25	50	100			500	1000	16.0	403.0	600
1119613	3 G 10	•	25	50	100			500	1000	14.6	288.0	466
1119614	4 G 10	•	25	50	100			500	1000	16.2	384.0	590
1119615	5 G 10	•	25	50	100			500	1000	18.1	480.0	722
1119617	7 G 10	•	25	50	100			500	1000	20.0	672.0	968
1119624	4 G 16	•		50	100			500		18.8	614.0	1,087
1119625	5 G 16	•		50	100			500		21.2	768.0	1,370
1119627	7 G 16	•		50	100			500		23.4	1,075.0	1,779
1119634	4 G 25	•		50	100			500		23.5	960.0	1,582
1119635	5 G 25	•		50	100			500		26.4	1,200.0	1,998
1119636	7 G 25	•		50	100			500		29.1	1,680.0	2,825
1119644	4 G 35	•		50	100			500		26.4	1,344.0	2,106
1119645	5 G 35	•		50	100			500		29.6	1,680.0	2,635

Copper price basis: EUR 150 / 100 kg

Packaging size: Coil ≤ 30 kg and ≤ 250 m, otherwise drum

Please specify the desired packaging size (e.g. 1 x 500 m drum or 5 x 100 m coils)

Comparable products

- ÖLFLEX® 191 see page 35

Accessories

- SKINTOP® CLICK see page 109

ÖLFLEX® CLASSIC 110 CY



Info

- EMC compliant
- VDE Reg. No. 7030

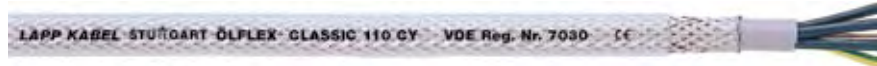

Benefits

- Space saving installation due to small cable diameters
- High electrical performance due to 4kV test voltage

Application range

- Plant engineering and construction
Industrial machinery
Air conditioning installations
- Conveying and transport systems
- In EMI critical environment (electromagnetic interference)

Product features

- Flame retardant according to IEC 60332-1-2
- Good chemical resistance see Appendix T1

- High coverage degree of the screen low transfer impedance (max. 250 Ω/km at 30 MHz)

Approvals (Norm references)



- Remark: A RoHS-non-compliant version is marketed under ÖLFLEX® 110 CY with VDE-REG.-Nr. 8067. To order this, please add appendix <1> to the above stated part numbers. This does not affect the above given further technical data or description.

Design

- Fine strands of bare copper wires
- PVC insulation LAPP P8/1
- PVC inner sheath, grey
- Screen made of tinned copper wire braid
- PVC outer sheath, transparent

Technical data

- Core identification code**
Black with white numbers acc. to VDE 0293
- Specific insulation resistance**
> 20 GΩhm x cm
- Conductor stranding**
Fine wire in accordance to VDE 0295 Class 5 / IEC 60228 Class 5
- Minimum bending radius**
Occasional flexing: 20 x cable diameter
Fixed installation: 6 x cable diameter
- Rated voltage**
U₀/U: 300/500 V
- Test voltage**
4000 V
- Protective conductor**
G = with protective conductor GN/YE
X = without protective conductor
- Range of temperature**
Occasional flexing: -5°C up to +70°C
Fixed installation: -40°C up to +80°C
- VDE tested**
VDE Reg. No. 7030 for sizes up to and including 60 cores

Part number	Number of cores and mm ² per conductor	Outer diameter in mm approx.	Copper index kg/km	Weight kg/km approx.
ÖLFLEX® CLASSIC 110 CY; U₀/U: 300/500 V				
1135752	2 X 0.5	7.0	41.0	75
1135003	3 G 0.5	7.3	45.5	83
1135753	3 X 0.5	7.3	45.5	83
1135004	4 G 0.5	7.9	55.0	99
1135754	4 X 0.5	7.9	55.0	99
1135005	5 G 0.5	8.4	66.0	112
1135755	5 X 0.5	8.4	66.0	112
1135007	7 G 0.5	8.9	80.5	132
1135757	7 X 0.5	8.9	80.5	132
1135012	12 G 0.5	11.3	138.5	202
1135762	12 X 0.5	11.3	138.5	202
1135018	18 G 0.5	13.3	156.4	289
1135025	25 G 0.5	15.2	250.0	378
1135030	30 G 0.5	16.1	297.0	429
1135040	40 G 0.5	18.2	343.0	542
1135802	2 X 0.75	7.4	46.0	86
1135103	3 G 0.75	7.9	57.9	100
1135803	3 X 0.75	7.9	57.9	100
1135104	4 G 0.75	8.4	64.0	115
1135804	4 X 0.75	8.4	64.0	115
1135105	5 G 0.75	8.9	77.4	130
1135805	5 X 0.75	8.9	77.4	130
1135107	7 G 0.75	9.7	102.0	161
1135807	7 X 0.75	9.7	102.0	161
1135112	12 G 0.75	12.3	177.0	247
1135812	12 X 0.75	12.3	177.0	247
1135118	18 G 0.75	14.5	243.0	356
1135818	18 X 0.75	14.5	243.0	356
1135125	25 G 0.75	16.6	307.3	465
1135134	34 G 0.75	18.9	323.2	601
1135840	40 X 0.75	20.5	369.4	734
1135141	41 G 0.75	20.6	488.0	728
1135852	2 X 1	7.9	56.0	98
1135203	3 G 1	8.2	65.3	111
1135853	3 X 1	8.2	65.3	111
1135204	4 G 1	8.7	78.1	130
1135854	4 X 1	8.7	78.1	130
1135205	5 G 1	9.5	89.4	153
1135207	7 G 1	10.2	113.3	185
1135212	12 G 1	13.3	188.1	307
1135216	16 G 1	14.6	216.0	390
1135218	18 G 1	15.5	286.0	418
1135225	25 G 1	17.5	388.5	544

Part number	Number of cores and mm ² per conductor	Outer diameter in mm approx.	Copper index kg/km	Weight kg/km approx.
1135234	34 G 1	20.3	505.0	738
1135241	41 G 1	22.0	578.0	864
1135250	50 G 1	23.8	688.0	1,011
1135902	2 X 1.5	8.5	65.0	117
1135303	3 G 1.5	8.9	83.0	136
1135903	3 X 1.5	8.9	83.0	136
1135304	4 G 1.5	9.6	100.0	163
1135904	4 X 1.5	9.6	100.0	163
1135305	5 G 1.5	10.3	125.0	188
1135905	5 X 1.5	10.3	125.0	188
1135307	7 G 1.5	11.3	149.0	237
1135907	7 X 1.5	11.3	149.0	237
1135312	12 G 1.5	14.8	280.0	393
1135318	18 G 1.5	17.2	389.0	538
1135325	25 G 1.5	20.1	535.0	745
1135334	34 G 1.5	22.8	702.0	964
1135341	41 G 1.5	24.7	844.6	1,123
1135350	50 G 1.5	27.1	1,006.0	1,372
1135402	2 X 2.5	9.9	112.0	202
1135403	3 G 2.5	10.3	146.0	192
1135404	4 G 2.5	11.3	167.0	233
1135405	5 G 2.5	12.6	200.0	283
1135407	7 G 2.5	13.9	288.0	371
1135412	12 G 2.5	17.6	477.3	585
1135502	2 X 4	11.4	120.0	247
1135504	4 G 4	13.4	237.0	347
1135505	5 G 4	14.7	280.0	413
1135602	2 X 6	13.6	180.0	353
1135604	4 G 6	15.8	318.0	485
1135605	5 G 6	17.0	441.0	702
1135607	7 G 6	18.8	530.0	950
1135702	2 X 10	16.4	256.0	492
1135615	3 G 10	17.4	362.4	507
1135614	4 G 10	19.0	558.0	735
1135616	5 G 10	21.2	595.0	847
1135617	7 G 10	23.2	796.0	1,039
1135622	2 X 16	18.6	390.0	698
1135624	4 G 16	22.2	804.0	1,395
1135623	5 G 16	26.7	935.0	1,440
1135626	4 G 25	28.7	1,161.0	1,730
1135627	5 G 25	31.6	1,400.0	2,090
1135625	4 G 35	32.0	1,543.0	2,210
1135628	5 G 35	35.5	1,901.0	2,710

Copper price basis: EUR 150 / 100 kg
 Please find our standard lengths at: www.lappkabel.de/en/cable-standardlengths
 Packaging size: Coil ≤ 30 kg and ≤ 250 m, otherwise drum
 Please specify the desired packaging size (e.g. 1 x 500 m drum or 5 x 100 m coils)

Comparable products

- ÖLFLEX® CLASSIC 110 CY BLACK 0,6/1 kV see page 21

Accessories

- SKINTOP® MS-SC-M BRUSH see page 115

Wide range use

PVC sheath and numbered cores

ÖLFLEX® CLASSIC 110 BLACK 0,6/1kV

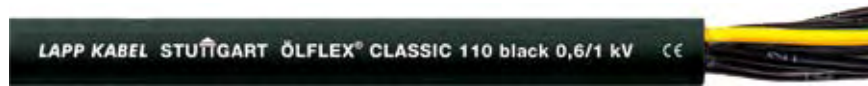

Info

- Suitable for outdoor applications

Benefits

- High electrical performance due to 4kV test voltage

Application range

- Plant engineering and construction
Industrial machinery
Air conditioning installations
Power station
Stage technique
- Fixed installation as well as occasional flexing at free, non-continuously recurring movement without tensile load
- Outdoor use suitable considering the temperature range

- Suitable for direct burial

Product features

- Flame retardant according to IEC 60332-1-2
- UV resistant and weather proof

Approvals (Norm references)



Design

- Fine strands of bare copper wires
- PVC insulation LAPP P8/1
- PVC outer sheath, black (RAL 9005)

Technical data



Core identification code
Black with white numbers acc. to VDE 0293
Based on
Cores accordance to VDE 0281 (H07V-K)
Sheath according to Italian standard CEI-UNEL 35755 + 35756



Specific insulation resistance
> 20 GOhm x cm



Conductor stranding
Fine wire in accordance to VDE 0293
Class 5 / IEC 60228 Class 5



Minimum bending radius
Occasional flexing: 15 x cable diameter
Fixed installation: 4 x cable diameter



Rated voltage
U₀/U: 600/1000 V



Test voltage
4000 V



Protective conductor
G = with protective conductor GN/YE
X = without protective conductor



Range of temperature
Occasional flexing: -5°C up to +70°C
Fixed installation: -40°C up to +80°C

Part number	Number of cores and mm² per conductor	Outer diameter in mm approx.	Copper index kg/km	Weight kg/km approx.
ÖLFLEX® CLASSIC 110 BK U0/U: 600/1000 V				
1120232	2 X 0.75	8.3	14.4	81
1120233	3 G 0.75	8.7	21.6	93
1120234	3 X 0.75	8.7	21.6	93
1120235	4 G 0.75	9.2	29.0	108
1120237	5 G 0.75	9.9	36.0	126
1120241	7 G 0.75	10.7	51.0	162
1120248	12 G 0.75	13.4	86.0	236
1120251	18 G 0.75	15.4	130.0	334
1120259	41 G 0.75	21.6	296.0	713
1120266	2 X 1	8.6	19.2	98
1120267	3 G 1	9.0	29.0	112
1120268	3 X 1	9.0	29.0	112
1120269	4 G 1	9.6	38.4	131
1120270	4 X 1	9.6	38.4	131
1120271	5 G 1	10.4	48.0	152
1120274	7 G 1	11.1	67.0	196
1120280	12 G 1	14.0	115.0	286
1120284	18 G 1	16.1	173.0	419
1120290	25 G 1	18.6	240.0	572
1120294	34 G 1	21.3	326.0	764
1120298	41 G 1	23.2	394.0	891
1120306	2 X 1.5	9.6	29.0	123
1120307	3 G 1.5	10.1	43.0	144
1120308	3 X 1.5	10.1	43.0	144
1120309	4 G 1.5	10.8	58.0	170
1120311	5 G 1.5	11.7	72.0	199
1120314	7 G 1.5	12.6	101.0	261
1120320	12 G 1.5	16.1	173.0	399
1120322	14 G 1.5	17.0	202.0	372
1120324	18 G 1.5	18.8	259.0	547
1120328	25 G 1.5	21.7	360.0	770

Part number	Number of cores and mm² per conductor	Outer diameter in mm approx.	Copper index kg/km	Weight kg/km approx.
1120330	34 G 1.5	24.9	490.0	996
1120333	50 G 1.5	29.8	720.0	1,427
1120339	2 X 2.5	10.8	48.0	147
1120340	3 G 2.5	11.3	72.0	182
1120342	4 G 2.5	12.2	96.0	225
1120343	4 X 2.5	12.2	96.0	225
1120344	5 G 2.5	13.3	120.0	266
1120346	7 G 2.5	14.4	168.0	354
1120349	12 G 2.5	18.7	288.0	540
1120350	14 G 2.5	19.8	336.0	542
1120351	18 G 2.5	22.0	432.0	788
1120353	25 G 2.5	25.8	600.0	1,094
1120360	4 G 4	13.8	154.0	324
1120361	5 G 4	15.1	192.0	385
1120362	7 G 4	16.4	269.0	513
1120366	4 G 6	15.1	230.0	442
1120367	5 G 6	16.8	288.0	526
1120368	7 G 6	18.2	403.0	705
1120370	4 G 10	18.7	384.0	707
1120371	5 G 10	20.7	480.0	881
1120374	4 G 16	21.3	614.0	1,100
1120375	5 G 16	23.6	768.0	1,600
1120376	7 G 16	26.2	1,075.0	1,890
1120378	4 G 25	26.2	960.0	1,600
1120379	5 G 25	29.0	1,200.0	2,050
1120382	4 G 35	29.1	1,344.0	2,400
1120383	5 G 35	32.5	1,680.0	2,900
1120385	4 G 50	35.6	1,920.0	3,400
1120387	4 G 70	40.7	2,688.0	5,050
1120389	4 G 95	46.8	3,648.0	6,010
1120390	4 G 120	53.5	4,608.0	7,500

Copper price basis: EUR 150 / 100 kg
Please find our standard lengths at: www.lappkabel.de/en/cable-standardlengths
Packaging size: Coil ≤ 30 kg and ≤ 250 m, otherwise drum
Please specify the desired packaging size (e.g. 1 x 500 m drum or 5 x 100 m coils)

Comparable products

- ÖLFLEX® CLASSIC 100 BK POWER 0,6/1kV see page 16
- ÖLFLEX® CLASSIC 130 H BK 0,6/1kV see page 29

Accessories

- SKINTOP® MS-M see page 113
- Cable shears KT 4 and KT 5

ÖLFLEX® CLASSIC 110 CY BLACK 0,6/1 kV



Info

- Suitable for outdoor applications
- EMC compliant



Benefits

- Space saving installation due to small cable diameters
- High electrical performance due to 4kV test voltage

Application range

- Plant engineering and construction
Industrial machinery
Air conditioning installations
Power station
- In EMI critical environment (electromagnetic interference)
- Fixed installation as well as occasional flexing at free, non-continuously recurring movement without tensile load
- Outdoor use suitable considering the temperature range
- Suitable for direct burial

Product features

- Flame retardant according to IEC 60332-1-2
- UV resistant and weather proof
- High coverage degree of the screen
low transfer impedance
(max. 250 Ω/km at 30 MHz)

Approvals (Norm references)



Design

- Fine strands of bare copper wires
- PVC insulation LAPP P8/1
- PVC inner sheath, black
- Screen made of tinned copper wire braid
- PVC outer sheath, black (RAL 9005)

Technical data

- Core identification code**
Black with white numbers acc. to VDE 0293
- Based on**
Cores accordance to VDE 0281 (H07V-K)
Sheath according to Italian standard CEI-UNEL 35755 + 35756
- Specific insulation resistance**
> 20 GOhm x cm
- Conductor stranding**
Fine wire in accordance to VDE 0295
Class 5 / IEC 60228 Class 5
- Minimum bending radius**
Occasional flexing: 20 x cable diameter
Fixed installation: 6 x cable diameter
- Rated voltage**
U₀/U: 600/1000 V
- Test voltage**
4000 V
- Protective conductor**
G = with protective conductor GN/YE
X = without protective conductor
- Range of temperature**
Occasional flexing: -5°C up to +70°C
Fixed installation: -40°C up to +80°C

Part number	Number of cores and mm² per conductor	Outer diameter in mm approx.	Copper index kg/km	Weight kg/km approx.
ÖLFLEX® CLASSIC 110 CY BK U0/U: 600/1000V				
1121232	2 X 0.75	10.5	46.0	183
1121233	3 G 0.75	10.9	56.0	210
1121235	4 G 0.75	11.4	67.0	238
1121236	4 X 0.75	11.4	67.0	238
1121237	5 G 0.75	12.1	78.0	272
1121241	7 G 0.75	12.9	97.0	315
1121247	12 G 0.75	15.8	168.0	464
1121251	18 G 0.75	18.0	229.0	616
1121254	25 G 0.75	20.7	296.0	762
1121266	2 X 1	10.8	52.0	198
1121267	3 G 1	11.2	66.0	228
1121268	3 X 1	11.2	66.0	228
1121269	4 G 1	11.8	79.0	261
1121270	4 X 1	11.8	79.0	261
1121271	5 G 1	12.6	93.0	300
1121274	7 G 1	13.3	117.0	335
1121280	12 G 1	16.4	204.0	522
1121284	18 G 1	18.7	280.0	687
1121290	25 G 1	21.6	369.0	884
1121306	2 X 1.5	11.8	69.0	243
1121307	3 G 1.5	12.3	87.0	273
1121308	3 X 1.5	12.3	87.0	273
1121309	4 G 1.5	13.0	102.0	290
1121310	4 X 1.5	13.0	102.0	290
1121311	5 G 1.5	13.9	125.0	352

Part number	Number of cores and mm² per conductor	Outer diameter in mm approx.	Copper index kg/km	Weight kg/km approx.
1121314	7 G 1.5	15.0	180.0	448
1121320	12 G 1.5	18.7	281.0	690
1121324	18 G 1.5	21.8	391.0	938
1121328	25 G 1.5	25.1	518.0	1,180
1121340	3 G 2.5	13.5	123.0	354
1121342	4 G 2.5	14.6	168.0	413
1121344	5 G 2.5	15.7	204.0	515
1121346	7 G 2.5	17.0	265.0	619
1121349	12 G 2.5	21.7	421.0	936
1121360	4 G 4	16.2	238.0	587
1121361	5 G 4	17.7	302.0	689
1121362	7 G 4	19.0	396.0	828
1121367	4 G 6	17.7	318.0	715
1121368	5 G 6	19.2	419.0	862
1121369	7 G 6	21.2	559.0	1,105
1121372	4 G 10	21.7	574.0	1,188
1121373	5 G 10	23.0	612.0	1,020
1121377	4 G 16	24.3	809.0	1,656
1121378	5 G 16	26.7	935.0	1,440
1121381	4 G 25	29.8	1,165.0	2,179
1121382	5 G 25	31.6	1,400.0	2,090
1121385	4 G 35	32.7	1,683.0	2,893
1121388	4 G 50	39.6	2,368.0	4,094
1121391	4 G 70	44.5	3,261.0	5,467
1121394	4 G 95	51.0	4,055.0	5,849
1121397	4 G 120	58.1	5,225.0	7,509

Copper price basis: EUR 150 / 100 kg
 Please find our standard lengths at: www.lappkabel.de/en/cable-standardlengths
 Packaging size: Coil ≤ 30 kg and ≤ 250 m, otherwise drum
 Please specify the desired packaging size (e.g. 1 x 500 m drum or 5 x 100 m coils)

Comparable products

- ÖLFLEX® CLASSIC 135 CH BK 0,6/1kV

Accessories

- SKINTOP® MS-SC-M BRUSH see page 115



Wide range use

PVC sheath and numbered cores

ÖLFLEX® CLASSIC 115 CY



Info

- EMC compliant
- Slim and light, without inner sheath

Benefits

- Space saving installation due to small cable diameters

- Good chemical resistance see Appendix T1

Application range

- Measurement and control technology
- Office machines and systems for data processing

Approvals (Norm references)



Product features

- Flame retardant according to IEC 60332-1-2

Design

- Fine strands of bare copper wires
- PVC insulation LAPP P8/1
- Screen made of tinned copper wire braid
- PVC outer sheath, grey (RAL 7001)

Technical data

Core identification code
Black with white numbers acc. to VDE 0293

Based on
HD 21.13 S1; VDE 0281 Part 13

Specific insulation resistance
> 20 GOhm x cm

Conductor stranding
Fine wire in accordance to VDE 0295 Class 5 / IEC 60228 Class 5

Minimum bending radius
Occasional flexing: 20 x cable diameter
Fixed installation: 6 x cable diameter

Rated voltage
U_c/U: 300/500 V

Test voltage
Core/core: 4000 V
Core/screen: 2000 V

Protective conductor
G = with protective conductor GN/YE
X = without protective conductor

Range of temperature
Occasional flexing: -5°C up to +70°C
Fixed installation: -40°C up to +80°C

Part number	Number of cores and mm ² per conductor	Outer diameter in mm approx.	Copper index kg/km	Weight kg/km approx.
ÖLFLEX® CLASSIC 115 CY; U0/U: 300/500 V				
1136752	2 X 0.5	5.8	36.0	45
1136003	3 G 0.5	6.1	43.0	59
1136753	3 X 0.5	6.1	43.0	59
1136004	4 G 0.5	6.5	49.0	83
1136754	4 X 0.5	6.5	49.0	83
1136005	5 G 0.5	7.0	57.0	96
1136755	5 X 0.5	7.0	57.0	96
1136007	7 G 0.5	7.5	69.0	136
1136757	7 X 0.5	7.5	69.0	136
1136012	12 G 0.5	9.9	104.0	200
1136762	12 X 0.5	9.9	104.0	200
1136018	18 G 0.5	11.5	141.0	275
1136768	18 X 0.5	11.5	141.0	275
1136025	25 G 0.5	13.4	211.0	350
1136775	25 X 0.5	13.4	211.0	350
1136802	2 X 0.75	6.2	43.0	56
1136103	3 G 0.75	6.5	52.0	70
1136803	3 X 0.75	6.5	52.0	70
1136104	4 G 0.75	7.0	61.0	95
1136804	4 X 0.75	7.0	61.0	95
1136105	5 G 0.75	7.7	72.0	130
1136805	5 X 0.75	7.7	72.0	130
1136107	7 G 0.75	8.3	89.0	168
1136807	7 X 0.75	8.3	89.0	168
1136112	12 G 0.75	10.9	138.0	232
1136118	18 G 0.75	12.7	211.0	315
1136125	25 G 0.75	14.8	280.0	435
1136825	25 X 0.75	14.8	280.0	435
1136852	2 X 1	6.5	51.0	84
1136203	3 G 1	6.8	62.0	110
1136853	3 X 1	6.8	62.0	110
1136204	4 G 1	7.3	74.0	130
1136854	4 X 1	7.3	74.0	130
1136205	5 G 1	8.1	88.0	156
1136855	5 X 1	8.1	88.0	156

Part number	Number of cores and mm ² per conductor	Outer diameter in mm approx.	Copper index kg/km	Weight kg/km approx.
1136207	7 G 1	8.8	112.0	192
1136857	7 X 1	8.8	112.0	192
1136212	12 G 1	11.5	185.0	285
1136218	18 G 1	13.9	268.0	395
1136225	25 G 1	15.9	354.0	656
1136902	2 X 1.5	7.1	65.0	97
1136303	3 G 1.5	7.5	82.0	125
1136903	3 X 1.5	7.5	82.0	125
1136304	4 G 1.5	8.2	100.0	165
1136904	4 X 1.5	8.2	100.0	165
1136305	5 G 1.5	8.9	119.0	193
1136905	5 X 1.5	8.9	119.0	193
1136307	7 G 1.5	9.9	154.0	245
1136907	7 X 1.5	9.9	154.0	245
1136312	12 G 1.5	13.0	268.0	365
1136318	18 G 1.5	15.6	373.0	553
1136325	25 G 1.5	17.9	530.0	734
1136334	34 G 1.5	20.8	683.0	944
1136403	3 G 2.5	8.9	118.0	188
1136404	4 G 2.5	9.9	147.0	236
1136405	5 G 2.5	11.0	176.0	270
1136407	7 G 2.5	11.9	253.0	340
1136412	12 G 2.5	16.0	355.0	589
1136418	18 G 2.5	19.0	569.0	978
1136425	25 G 2.5	22.2	827.0	1,358
1136504	4 G 4	11.6	248.0	305
1136507	7 G 4	14.4	355.0	500
1136604	4 G 6	14.2	343.0	440
1136607	7 G 6	17.0	505.0	672
1136614	4 G 10	17.2	535.0	710
1136615	5 G 10	19.5	592.0	824
1136624	4 G 16	20.2	800.0	1,050
1136625	5 G 16	22.6	895.0	1,285
1136634	4 G 25	25.1	1,075.0	1,570
1136635	5 G 25	28.0	1,400.0	1,976
1136638	4 G 35	30.4	1,576.0	2,070

Copper price basis: EUR 150 / 100 kg

Please find our standard lengths at: www.lappkabel.de/en/cable-standardlengths

Packaging size: Coil ≤ 30 kg and ≤ 250 m, otherwise drum

Please specify the desired packaging size (e.g. 1 x 500 m drum or 5 x 100 m coils)

Comparable products

- ÖLFLEX® ROBUST 215 C see page 43
- ÖLFLEX® CLASSIC 110 CY see page 19

Accessories

- 3M Scotch 1183 screening tape
- SKINTOP® MS-SC-M BRUSH see page 115

ÖLFLEX® CLASSIC 100 H



Info

- **Amendment: out-phased product!**
<Trimmed size range>
- **Sizes with conductor cross section smaller than 35 mm² see ÖLFLEX® CLASSIC 130 H BK 0,6/1kV**

Application range

- Public buildings
- Airport, railway station
- Plant engineering and construction
Industrial machinery
Air conditioning installations
- Particularly where human and animal life as well as valuable property are exposed to high risk of fire hazards

Product features

- Flame retardant according to IEC 60332-1-2 (flame spread on single cable)
- No flame propagation acc. to IEC 60332-3-24 respectively IEC 60332-3-25 (Flame spread on vertical cable or wire bundle)

- Halogen-free according to IEC 60754-1 (amount of halogen acid gas)
Corrosiveness of combustion gases according to IEC 60754-2 (degree of acidity)
- Oil resistant according to SEV TB 20 B

Approvals (Norm references)



Design

- Fine strands of bare copper wires
- Core insulation: Halogen-free
- Special blended halogen-free outer sheath grey (RAL 7001)

Technical data

- Core identification code**
Coloured according to VDE 0293-308 see Appendix T9
- Based on**
HD 21.13 S1; VDE 0281 Part 13
HD 21.5; VDE 0281 Part 5
- Specific insulation resistance**
> 20 GOhm x cm
- Conductor stranding**
Fine wire in accordance to VDE 0295
Class 5 / IEC 60228 Class 5
- Minimum bending radius**
Occasional flexing: 15 x cable diameter
Fixed installation: 4 x cable diameter
- Rated voltage**
U0/U: 450/750
fixed, protected installation:
U0/U: 600/1000 V
- Test voltage**
4000 V
- Protective conductor**
G = with protective conductor GN/YE
X = without protective conductor
- Range of temperature**
Occasional flexing: -30°C up to +70°C
Fixed installation: -40°C up to +80°C

Part number	Number of cores and mm ² per conductor	Outer diameter in mm approx.	Copper index kg/km	Weight kg/km approx.
00141173	4 G 35	32.8	1,344.0	2,060
00141183	5 G 35	37.6	1,680.0	2,577
00141193	4 G 50	38.0	1,920.0	2,811
00141203	4 G 70	42.8	2,688.0	3,968
00141213	4 G 95	47.1	3,648.0	4,957
00141223	4 G 120	52.4	4,608.0	6,391

Copper price basis: EUR 150 / 100 kg
 Please find our standard lengths at: www.lappkabel.de/en/cable-standardlengths
 Packaging size: Coil ≤ 30 kg and ≤ 250 m, otherwise drum
 Please specify the desired packaging size (e.g. 1 x 500 m drum or 5 x 100 m coils)
 Single lengths for sizes: ≥ 4G50 max. 500m; ≥ 4G120 max. 400m

Comparable products

- ÖLFLEX® CLASSIC 130 H BK 0,6/1kV see page 29

Accessories

- SKINTOP® ST-HF-M see page 110



Source: PowerWind GmbH



Wide range use

Halogen-free

ÖLFLEX® CLASSIC 110 H

VDE certified characteristics



Info

- New improved version !
- High flexibility and oil resistance

Application range

- Public buildings
- Airport, railway station
- Plant engineering and construction
Industrial machinery
Air conditioning installations
Stage technique
- Particularly where human and animal life as well as valuable property are exposed to high risk of fire hazards

- Halogen-free according to IEC 60754-1 (amount of halogen acid gas)
Corrosiveness of combustion gases according to IEC 60754-2 (degree of acidity)
- Low smoke density acc. to IEC 61034
- Oil resistant acc. to VDE 0473 part 811-2-1 and UL OIL RES I and UL OIL RES II

Approvals (Norm references)



Product features

- Flame retardant according to IEC 60332-1-2 (flame spread on single cable)
- No flame propagation acc. to IEC 60332-3-24 respectively IEC 60332-3-25 (Flame spread on vertical cable or wire bundle)

Design

- Fine strands of bare copper wires
- Core insulation: Halogen-free
- Special blended halogen-free outer sheath grey (RAL 7001)

Technical data

- Core identification code**
Black with white numbers acc. to VDE 0293
- Based on**
HD 21.13 S1; VDE 0281 Part 13
HD 21.5; VDE 0281 Part 5
- Specific insulation resistance**
> 20 GOhm x cm
- Conductor stranding**
Fine wire in accordance to VDE 0295
Class 5 / IEC 60228 Class 5
- Minimum bending radius**
Occasional flexing: 10 x cable diameter
Fixed installation: 4 x cable diameter
- Rated voltage**
U₀/U: 300/500 V
- Test voltage**
4000 V
- Protective conductor**
G = with protective conductor GN/YE
X = without protective conductor
- Range of temperature**
Occasional flexing: -30°C up to +70°C
Fixed installation: -40°C up to +80°C

Part number	Number of cores and mm² per conductor	Outer diameter in mm approx.	Copper index kg/km	Weight kg/km approx.
ÖLFLEX® CLASSIC 110 H U0/U: 300/500 V				
10019900	2 X 0.5	4.9	9.6	41
10019901	3 G 0.5	5.2	14.4	49
10019902	3 X 0.5	5.2	14.4	49
10019903	4 G 0.5	5.8	19.2	58
10019904	4 X 0.5	5.8	19.2	58
10019905	5 G 0.5	6.3	24.0	69
10019906	7 G 0.5	6.9	33.6	87
10019907	12 G 0.5	9.1	57.6	141
10019910	2 X 0.75	5.5	14.4	51
10019911	3 G 0.75	5.8	21.6	61
10019912	3 X 0.75	5.8	21.6	61
10019913	4 G 0.75	6.3	28.8	73
10019914	4 X 0.75	6.3	28.8	73
10019915	5 G 0.75	6.9	36.0	87
10019916	5 X 0.75	6.9	36.0	87
10019917	7 G 0.75	7.5	50.4	111
10019918	7 X 0.75	7.5	50.4	111
10019919	9 G 0.75	9.6	64.8	150
10019920	12 G 0.75	10.1	86.4	186
10019921	18 G 0.75	12.0	129.6	265
10019922	25 G 0.75	14.1	180.0	365
10019960	2 X 1	5.8	19.2	59
10019961	3 G 1	6.1	28.8	72
10019962	3 X 1	6.1	28.8	72
10019963	4 G 1	6.6	38.4	87
10019964	4 X 1	6.6	38.4	87
10019965	5 G 1	7.3	48.0	104
10019967	7 G 1	8.1	67.2	138
10019968	8 G 1	9.7	76.8	164
10019969	12 G 1	10.7	115.2	225
10019970	14 G 1	11.4	134.4	261
10019971	18 G 1	12.9	172.8	328
10019972	25 G 1	15.0	240.0	445

Part number	Number of cores and mm² per conductor	Outer diameter in mm approx.	Copper index kg/km	Weight kg/km approx.
10019973	41 G 1	19.2	393.6	719
10019930	2 X 1.5	6.4	28.8	76
10019931	3 G 1.5	6.8	43.2	94
10019980	3 X 1.5	6.8	43.2	94
10019932	4 G 1.5	7.4	57.6	115
10019933	5 G 1.5	8.3	72.0	142
10019934	7 G 1.5	9.0	100.8	184
10019981	8 G 1.5	10.8	115.2	218
10019982	9 G 1.5	11.6	129.6	245
10019935	12 G 1.5	12.2	172.8	308
10019936	14 G 1.5	13.0	201.6	357
10019937	18 G 1.5	14.6	259.2	449
10019938	25 G 1.5	17.2	360.0	617
10019927	34 G 1.5	19.8	489.6	821
10019944	2 X 2.5	7.6	48.0	113
10019945	3 G 2.5	8.3	72.0	146
10019946	4 G 2.5	9.0	96.0	180
10019947	5 G 2.5	10.1	120.0	221
10019948	7 G 2.5	11.2	168.0	295
10019949	12 G 2.5	15.1	288.0	491
10019950	4 G 4	10.8	153.6	268
10019951	5 G 4	12.1	192.0	328
10019952	7 G 4	13.4	268.8	438
10019953	4 G 6	13.0	230.4	391
10019954	5 G 6	14.5	288.0	478
10019975	7 G 6	16.0	403.2	638
10019851	4 G 10	16.2	384.0	635
10019852	5 G 10	18.1	480.0	775
10019849	4 G 16	18.8	614.4	930
10019853	5 G 16	21.2	768.0	1,147
10019854	4 G 25	23.5	960.0	1,442
10019855	5 G 25	26.4	1,200.0	1,773
10019856	4 G 35	26.6	1,344.0	1,917

Copper price basis: EUR 150 / 100 kg
 Please find our standard lengths at: www.lappkabel.de/en/cable-standardlengths
 Packaging size: Coil ≤ 30 kg and ≤ 250 m, otherwise drum
 Please specify the desired packaging size (e.g. 1 x 500 m drum or 5 x 100 m coils)

Comparable products

- ÖLFLEX® CLASSIC 130 H see page 28
- ÖLFLEX® CLASSIC 130 H BK 0,6/1kV see page 29

Accessories

- SKINTOP® ST-HF-M see page 110
- MULTICRIMP 6 crimping pliers

ÖLFLEX® CLASSIC 110 CH
VDE certified characteristics



Info

- New improved version !
- High flexibility and oil resistance
- EMC compliant

Application range

- Public buildings
- Airport, railway station
- Plant engineering and construction
Industrial machinery
Air conditioning installations
- Particularly where human and animal life as well as valuable property are exposed to high risk of fire hazards
- In EMI critical environment (electromagnetic interference)

Product features

- Flame retardant according to IEC 60332-1-2 (flame spread on single cable)
- No flame propagation acc. to IEC 60332-3-24 respectively IEC 60332-3-25 (Flame spread on vertical cable or wire bundle)

- Halogen-free according to IEC 60754-1 (amount of halogen acid gas)
Corrosiveness of combustion gases according to IEC 60754-2 (degree of acidity)
- Low smoke density acc. to IEC 61034
- Oil resistant acc. to VDE 0473 part 811-2-1 and UL OIL RES I and UL OIL RES II

Approvals (Norm references)



Design

- Fine strands of bare copper wires
- Core insulation: Halogen-free
- Halogen-free inner sheath, grey
- Screen made of tinned copper wire braid
- Special blended halogen-free outer sheath grey (RAL 7001)

Technical data

- Core identification code**
Black with white numbers acc. to VDE 0293
- Based on**
HD 21.13 S1; VDE 0281 Part 13
HD 21.5; VDE 0281 Part 5
- Specific insulation resistance**
> 20 GOhm x cm
- Conductor stranding**
Fine wire in accordance to VDE 0295
Class 5 / IEC 60228 Class 5
- Minimum bending radius**
Occasional flexing: 10 x cable diameter
Fixed installation: 6 x cable diameter
- Rated voltage**
U₀/U: 300/500 V
- Test voltage**
4000 V
- Protective conductor**
G = with protective conductor GN/YE
X = without protective conductor
- Range of temperature**
Occasional flexing: -30°C up to +70°C
Fixed installation: -40°C up to +80°C

Part number	Number of cores and mm² per conductor	Outer diameter in mm approx.	Copper index kg/km	Weight kg/km approx.
ÖLFLEX® CLASSIC 110 CH U0/U: 300/500 V				
10035030	2 X 0.5	7.1	29.1	85
10035031	3 G 0.5	7.4	35.1	95
10035032	3 X 0.5	7.4	35.1	95
10035033	4 G 0.5	8.0	41.4	111
10035034	4 X 0.5	8.0	41.4	111
10035035	5 G 0.5	8.6	48.0	126
10035036	7 G 0.5	9.1	59.9	148
10035037	12 G 0.5	11.5	91.4	226
10035040	2 X 0.75	7.7	35.4	101
10035041	3 G 0.75	8.0	43.8	114
10035042	3 X 0.75	8.0	43.8	114
10035043	4 G 0.75	8.5	52.8	130
10035044	4 X 0.75	8.5	52.8	130
10035045	5 G 0.75	9.3	62.3	153
10035046	5 X 0.75	9.3	62.3	153
10035047	7 G 0.75	9.9	79.5	183
10035048	7 X 0.75	9.9	79.5	183
10035050	12 G 0.75	12.5	123.2	280
10035051	18 G 0.75	14.8	188.6	399
10035052	25 G 0.75	16.9	247.5	522
10035055	2 X 1	8.0	41.4	112
10035056	3 G 1	8.4	52.1	127
10035057	3 X 1	8.4	52.1	127
10035058	4 G 1	8.9	73.5	157
10035059	4 X 1	8.9	73.5	157
10035060	5 G 1	9.7	83.2	171
10035061	7 G 1	10.3	97.2	210
10035062	12 G 1	13.6	168.7	347
10035063	18 G 1	15.7	235.4	474
10035064	25 G 1	17.8	312.0	611

Part number	Number of cores and mm² per conductor	Outer diameter in mm approx.	Copper index kg/km	Weight kg/km approx.
10035065	41 G 1	22.4	508.0	969
10035067	2 X 1.5	8.6	53.2	134
10035068	3 G 1.5	9.0	69.1	155
10035069	3 X 1.5	9.0	69.1	155
10035070	4 G 1.5	9.8	85.8	186
10035071	5 G 1.5	10.5	102.8	215
10035072	7 G 1.5	11.4	134.2	269
10035073	12 G 1.5	15.0	232.8	445
10035074	18 G 1.5	17.4	327.8	610
10035075	25 G 1.5	20.4	463.2	843
10035089	3 G 2.5	10.5	102.8	220
10035090	4 G 2.5	11.4	129.4	265
10035091	5 G 2.5	12.7	157.5	322
10035092	7 G 2.5	14.0	223.0	422
10035093	12 G 2.5	17.9	360.5	659
10035094	4 G 4	13.6	207.6	390
10035095	5 G 4	14.9	251.5	463
10035096	7 G 4	16.2	333.9	588
10035097	4 G 6	15.8	294.8	516
10035098	5 G 6	17.3	356.1	616
10035099	7 G 6	18.8	479.3	792
10035380	4 G 10	19.1	461.1	789
10035381	5 G 10	21.4	586.6	998
10035382	4 G 16	22.3	727.6	1,154
10035383	5 G 16	24.5	888.7	1,389
10035384	4 G 25	27.0	1,123.9	1,807
10035385	5 G 25	30.1	1,405.0	2,140
10035386	4 G 35	30.4	1,529.2	2,321
0035388	4 G 50	42.4	2,162.0	3,741
0035390	4 G 70	47.6	2,973.0	5,054
0035392	4 G 95	51.7	3,966.0	6,427

Copper price basis: EUR 150 / 100 kg
 Please find our standard lengths at: www.lappkabel.de/en/cable-standardlengths
 Packaging size: Coil ≤ 30 kg and ≤ 250 m, otherwise drum
 Please specify the desired packaging size (e.g. 1 x 500 m drum or 5 x 100 m coils)
 Single lengths for sizes: ≥ 4G50 max. 500m

Comparable products

- ÖLFLEX® CLASSIC 135 CH see page 32
- ÖLFLEX® CLASSIC 135 CH BK 0,6/1kV

Accessories

- SKINTOP® MS-SC-M BRUSH see page 115
- SKINTOP® ST-HF-M see page 110

Wide range use

Halogen-free

ÖLFLEX® 120 H



Info

- Amendment: out-phased product! <Trimmed size range>
- Further sizes see alternative option ÖLFLEX® CLASSIC 110 H

■ Application range

- Public buildings
- Airport, railway station
- Plant engineering and construction
Industrial machinery
Air conditioning installations
- Particularly where human and animal life as well as valuable property are exposed to high risk of fire hazards

- Halogen-free according to IEC 60754-1 (amount of halogen acid gas)
Corrosiveness of combustion gases according to IEC 60754-2 (degree of acidity)
- Flexible down to -25°C

■ Approvals (Norm references)



■ Product features

- Flame retardant according to IEC 60332-1-2 (flame spread on single cable)

■ Design

- Fine strands of bare copper wires
- Core insulation: Halogen-free
- Special blended halogen-free outer sheath grey (RAL 7001)

■ Technical data

- Core identification code**
Black with white numbers acc. to VDE 0293
- Based on**
HD 21.13 S1; VDE 0281 Part 13
- Specific insulation resistance**
> 10 GOhm x cm
- Conductor stranding**
Fine wire in accordance to VDE 0295
Class 5 / IEC 60228 Class 5
- Minimum bending radius**
Occasional flexing: 15 x cable diameter
Fixed installation: 4 x cable diameter
- Rated voltage**
U_c/U: 300/500 V
- Test voltage**
4000 V
- Protective conductor**
G = with protective conductor GN/YE
X = without protective conductor
- Range of temperature**
Occasional flexing: -25°C up to +70°C
Fixed installation: -40°C up to +70°C

Part number	Number of cores and mm ² per conductor	Outer diameter in mm approx.	Copper index kg/km	Weight kg/km approx.
ÖLFLEX® 120 H U0/U: 300/500 V				
1021902	2 X 1.5	6.3	29.0	63
1021303	3 G 1.5	6.7	43.0	79
1021304	4 G 1.5	7.2	58.0	98
1021305	5 G 1.5	8.1	72.0	120
1021307	7 G 1.5	8.9	101.0	158
1021312	12 G 1.5	12.0	173.0	265
1021318	18 G 1.5	14.4	259.0	388
1021325	25 G 1.5	16.9	360.0	535
1021403	3 G 2.5	8.1	72.0	124
1021404	4 G 2.5	8.9	96.0	154
1021405	5 G 2.5	10.0	120.0	189
1021407	7 G 2.5	11.1	168.0	254
1021412	12 G 2.5	14.8	288.0	425
1021504	4 G 4	10.8	154.0	236
1021604	4 G 6	13.0	230.0	350

Copper price basis: EUR 150 / 100 kg

Please find our standard lengths at: www.lappkabel.de/en/cable-standardlengths

Packaging size: Coil ≤ 30 kg and ≤ 250 m, otherwise drum

Please specify the desired packaging size (e.g. 1 x 500 m drum or 5 x 100 m coils)

■ Comparable products

- ÖLFLEX® CLASSIC 110 H see page 24
- ÖLFLEX® CLASSIC 130 H see page 28
- ÖLFLEX® CLASSIC 130 H BK 0,6/1kV see page 29

■ Accessories

- SKINTOP® ST-HF-M see page 110

ÖLFLEX® 120 CH



Info

- Amendment: out-phased product! <Trimmed size range>
- Further sizes see alternative option ÖLFLEX® CLASSIC 110 CH

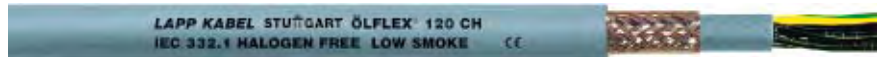

Application range

- Public buildings
- Airport, railway station
- Plant engineering and construction
Industrial machinery
Air conditioning installations
- Particularly where human and animal life as well as valuable property are exposed to high risk of fire hazards
- In EMI critical environment (electromagnetic interference)

Product features

- Flame retardant according to IEC 60332-1-2 (flame spread on single cable)
- Halogen-free according to IEC 60754-1 (amount of halogen acid gas)
Corrosiveness of combustion gases according to IEC 60754-2 (degree of acidity)

- Flexible down to -25°C
- High coverage degree of the screen low transfer impedance (max. 250 Ω/km at 30 MHz)

Approvals (Norm references)



Design

- Fine strands of bare copper wires
- Core insulation: Halogen-free
- Halogen-free inner sheath, grey
- Screen made of tinned copper wire braid
- Special blended halogen-free outer sheath grey (RAL 7001)

Technical data

- Core identification code**
Black with white numbers acc. to VDE 0293
- Based on**
HD 21.13 S1; VDE 0281 Part 13
- Specific insulation resistance**
> 10 GΩhm x cm
- Conductor stranding**
Fine wire in accordance to VDE 0295 Class 5 / IEC 60228 Class 5
- Minimum bending radius**
Occasional flexing: 20 x cable diameter
Fixed installation: 6 x cable diameter
- Rated voltage**
U₀/U: 300/500 V
- Test voltage**
4000 V
- Protective conductor**
G = with protective conductor GN/YE
X = without protective conductor
- Range of temperature**
Occasional flexing: -25°C up to +70°C
Fixed installation: -40°C up to +70°C

Part number	Number of cores and mm ² per conductor	Outer diameter in mm approx.	Copper index kg/km	Weight kg/km approx.
ÖLFLEX® 120 CH U0/U: 300/500 V				
1022902	2 X 1.5	8.5	65.0	113
1022303	3 G 1.5	8.9	83.0	131
1022304	4 G 1.5	9.6	100.0	158
1022305	5 G 1.5	10.3	125.0	182
1022307	7 G 1.5	11.3	196.0	230
1022312	12 G 1.5	14.8	280.0	383
1022318	18 G 1.5	17.2	389.0	525
1022325	25 G 1.5	20.1	535.0	727
1022403	3 G 2.5	10.3	146.0	186
1022404	4 G 2.5	11.3	167.0	226
1022405	5 G 2.5	12.6	200.0	275
1022407	7 G 2.5	13.9	288.0	361
1022504	4 G 4	13.4	237.0	337
1022604	4 G 6	15.8	318.0	474

Copper price basis: EUR 150 / 100 kg

Please find our standard lengths at: www.lappkabel.de/en/cable-standardlengths

Packaging size: Coil ≤ 30 kg and ≤ 250 m, otherwise drum

Please specify the desired packaging size (e.g. 1 x 500 m drum or 5 x 100 m coils)

Comparable products

- ÖLFLEX® CLASSIC 110 CH see page 25
- ÖLFLEX® CLASSIC 135 CH see page 32
- ÖLFLEX® CLASSIC 135 CH BK 0,6/1kV

Accessories

- SKINTOP® CLICK see page 109
- SKINTOP® MS-SC-M see page 114



Source: PowerWind GmbH



Wide range use

Halogen-free

ÖLFLEX® CLASSIC 130 H

VDE certified characteristics



Info

- Now with additional flame test acc. to NF C 32-070 categorie C1
- For UL AWM version please add "A" to the common part number

Application range

- Public buildings
- Airport, railway station
- Plant engineering and construction
Industrial machinery
Air conditioning installations
Stage technique
- Particularly where human and animal life as well as valuable property are exposed to high risk of fire hazards

- No flame propagation according to NF C 32-070 category C1
- Halogen-free according to IEC 60754-1 (amount of halogen acid gas)
Corrosiveness of combustion gases according to IEC 60754-2 (degree of acidity)
- Low smoke density acc. to IEC 61034

Approvals (Norm references)



Product features

- Flame retardant according to IEC 60332-1-2 (flame spread on single cable)
- No flame propagation acc. to IEC 60332-3-24 respectively IEC 60332-3-25 (Flame spread on vertical cable or wire bundle)

Design

- Fine strands of bare copper wires
- Core insulation: Halogen-free
- Special blended halogen-free outer sheath grey (RAL 7001)

Technical data

Core identification code
Black with white numbers acc. to VDE 0293

Based on
VDE 0281 Part 14

Specific insulation resistance
>10 MOhm x km

Conductor stranding
Fine wire in accordance to VDE 0295 Class 5 / IEC 60228 Class 5

Minimum bending radius
Occasional flexing: 15 x cable diameter
Fixed installation: 4 x cable diameter

Rated voltage
U₂/U₁: 300/500 V

Test voltage
4000 V

Protective conductor
G = with protective conductor GN/YE
X = without protective conductor

Range of temperature
Occasional flexing: -15°C to +70°C
Fixed installation: -40°C up to +70°C

Part number	Number of cores and mm ² per conductor	Outer diameter in mm approx.	Copper index kg/km	Weight kg/km approx.
ÖLFLEX® CLASSIC 130 H				
1123000	2 X 0.5	4.8	9.6	36
1123001	3 G 0.5	5.1	14.4	42
1123002	3 X 0.5	5.1	14.4	42
1123003	4 G 0.5	5.7	19.2	55
1123004	4 X 0.5	5.7	19.2	55
1123005	5 G 0.5	6.2	24.0	65
1123006	5 X 0.5	6.2	24.0	65
1123008	7 G 0.5	6.8	33.6	80
1123009	7 X 0.5	6.8	33.6	80
1123010	8 G 0.5	8.0	38.4	103
1123012	10 G 0.5	8.6	48.0	112
1123013	12 G 0.5	8.9	57.6	128
1123017	18 G 0.5	10.6	86.4	189
1123020	25 G 0.5	12.8	120.0	260
1123021	30 G 0.5	13.2	144.0	294
1123032	2 X 0.75	5.4	14.4	47
1123033	3 G 0.75	5.7	21.6	56
1123034	3 X 0.75	5.7	21.6	56
1123035	4 G 0.75	6.2	28.8	69
1123036	4 X 0.75	6.2	28.8	69
1123037	5 G 0.75	6.8	36.0	83
1123038	5 X 0.75	6.8	36.0	83
1123041	7 G 0.75	7.4	50.4	104
1123042	7 X 0.75	7.4	50.4	104
1123046	10 G 0.75	9.6	72.0	149
1123047	12 G 0.75	9.9	86.4	172
1123048	12 X 0.75	9.9	86.4	172
1123051	18 G 0.75	11.8	129.6	252
1123054	25 G 0.75	14.4	180.0	352
1123056	34 G 0.75	16.3	244.8	466
1123066	2 X 1	5.7	19.2	55
1123067	3 G 1	6.0	28.8	67
1123068	3 X 1	6.0	28.8	67
1123069	4 G 1	6.6	38.4	83
1123070	4 X 1	6.6	38.4	83
1123071	5 G 1	7.2	48.0	100
1123072	5 X 1	7.2	48.0	100
1123074	7 G 1	8.0	67.2	130
1123075	7 X 1	8.0	67.2	130
1123076	8 G 1	9.5	76.8	164
1123078	10 G 1	10.3	96.0	183
1123080	12 G 1	10.6	115.2	212

Part number	Number of cores and mm ² per conductor	Outer diameter in mm approx.	Copper index kg/km	Weight kg/km approx.
1123081	12 X 1	10.6	115.2	212
1123083	16 G 1	11.9	153.6	275
1123084	18 G 1	12.7	172.8	314
1123090	25 G 1	15.3	240.0	429
1123094	34 G 1	17.3	326.4	570
1123106	2 X 1.5	6.3	28.8	72
1123107	3 G 1.5	6.7	43.2	88
1123108	3 X 1.5	6.7	43.2	88
1123109	4 G 1.5	7.3	57.6	110
1123110	4 X 1.5	7.3	57.6	110
1123111	5 G 1.5	8.1	72.0	135
1123112	5 X 1.5	8.1	72.0	135
1123114	7 G 1.5	8.9	100.8	174
1123115	7 X 1.5	8.9	100.8	174
1123116	8 G 1.5	10.7	115.2	223
1123118	10 G 1.5	11.6	144.0	250
1123120	12 G 1.5	12.0	172.8	289
1123124	18 G 1.5	13.4	259.2	433
1123128	25 G 1.5	17.4	360.0	596
1123130	34 G 1.5	19.6	489.6	786
1123139	2 X 2.5	7.6	48.0	110
1123140	3 G 2.5	8.1	72.0	137
1123142	4 G 2.5	8.9	96.0	174
1123144	5 G 2.5	10.0	120.0	217
1123146	7 G 2.5	11.1	168.0	283
1123149	12 G 2.5	14.9	288.0	467
1123151	18 G 2.5	17.8	432.0	696
1123153	25 G 2.5	21.3	600.0	969
1123159	3 G 4	9.9	115.2	213
1123160	4 G 4	10.8	153.6	267
1123161	5 G 4	12.1	192.0	331
1123162	7 G 4	13.4	268.8	432
1123166	3 G 6	11.7	172.8	303
1123167	4 G 6	13.0	230.4	388
1123168	5 G 6	14.5	288.0	480
1123169	7 G 6	16.0	403.2	626
1123172	4 G 10	16.2	384.0	601
1123173	5 G 10	18.1	480.0	735
1123177	4 G 16	18.8	614.4	917
1123178	5 G 16	21.2	768.0	1,148
1123181	4 G 25	23.5	960.0	1,418
1123182	5 G 25	28.4	1,200.0	1,769
1123185	4 G 35	26.4	1,344.0	1,905

Copper price basis: EUR 150 / 100 kg
Please find our standard lengths at: www.lappkabel.de/en/cable-standardlengths
Packaging size: Coil ≤ 30 kg and ≤ 250 m, otherwise drum
Please specify the desired packaging size (e.g. 1 x 500 m drum or 5 x 100 m coils)

Comparable products

- ÖLFLEX® CLASSIC 130 H BK 0,6/1kV see page 29

Accessories

- SKINTOP® ST-HF-M see page 110

New

ÖLFLEX® CLASSIC 130 H BK 0,6/1kV



Info

- Colour coded up to 5 cores
- Numbered cores from 6 up



Application range

- Public buildings
- Airport, railway station
- Plant engineering and construction
Industrial machinery
Air conditioning installations
- Particularly where human and animal life as well as valuable property are exposed to high risk of fire hazards
- Outdoor use (temporary) accordance to HD 516 S2 see Appendix A respectively VDE 0298-300

Product features

- Flame retardant according to IEC 60332-1-2 (flame spread on single cable)
- No flame propagation acc. to IEC 60332-3-24 respectively IEC 60332-3-25 (Flame spread on vertical cable or wire bundle)

- Halogen-free according to IEC 60754-1 (amount of halogen acid gas)
Corrosiveness of combustion gases according to IEC 60754-2 (degree of acidity)
- Low smoke density acc. to IEC 61034
- UV resistant

Approvals (Norm references)



Design

- Fine strands of bare copper wires
- Core insulation: Halogen-free
- Special halogen-free outer sheath black (RAL 9005)

Technical data

- Core identification code**
Up to 5 cores: According to VDE 0293-308 Appendix T9)
Starting at 6 cores: Black with white numbers
- Based on**
HD 21.14 S1
VDE 0281 Part 14
- Specific insulation resistance**
> 20 GOhm x cm
- Conductor stranding**
Fine wire in accordance to VDE 0295 Class 5 / IEC 60228 Class 5
- Minimum bending radius**
Occasional flexing: 15 x cable diameter
Fixed installation: 4 x cable diameter
- Rated voltage**
U₀/U: 600/1000 V
- Test voltage**
4000 V
- Protective conductor**
G = with protective conductor GN/YE
X = without protective conductor
- Range of temperature**
Occasional flexing: -15°C to +70°C
Fixed installation: -40°C up to +70°C

Part number	Number of cores and mm² per conductor	Outer diameter in mm approx.	Copper index kg/km	Weight kg/km approx.
ÖLFLEX® CLASSIC 130 H 0,6/1kV - coloured cores				
1123410	2 X 1	8.6	19.2	107
1123411	3 G 1	9.0	28.8	123
1123412	4 G 1	9.6	38.4	144
1123413	5 G 1	10.4	48.0	167
ÖLFLEX® CLASSIC 130 H 0,6/1kV - numbered cores				
1123414	7 G 1	11.1	67.2	206
1123415	12 G 1	14.0	115.2	314
1123416	18 G 1	16.1	172.8	428
1123417	25 G 1	18.6	240.0	569
ÖLFLEX® CLASSIC 130 H 0,6/1kV - coloured cores				
1123418	2 X 1.5	9.6	28.8	137
1123419	3 G 1.5	10.1	43.2	161
1123420	4 G 1.5	10.8	57.6	190
1123421	5 G 1.5	11.7	72.0	221
ÖLFLEX® CLASSIC 130 H 0,6/1kV - numbered cores				
1123422	7 G 1.5	12.6	100.8	276
1123423	12 G 1.5	16.1	172.8	427
1123424	18 G 1.5	18.8	259.2	596
1123425	25 G 1.5	21.7	360.0	799
ÖLFLEX® CLASSIC 130 H 0,6/1kV - coloured cores				

Part number	Number of cores and mm² per conductor	Outer diameter in mm approx.	Copper index kg/km	Weight kg/km approx.
1123426	2 X 2.5	10.8	48.0	184
1123427	3 G 2.5	11.3	72.0	219
1123428	4 G 2.5	12.2	96.0	262
1123429	5 G 2.5	13.3	120.0	307
ÖLFLEX® CLASSIC 130 H 0,6/1kV - numbered cores				
1123430	7 G 2.5	14.4	168.0	390
1123431	12 G 2.5	18.7	288.0	624
1123432	18 G 2.5	22.0	432.0	879
1123433	25 G 2.5	25.8	600.0	1,212
ÖLFLEX® CLASSIC 130 H 0,6/1kV - coloured cores				
1123434	3 G 4	12.6	115.2	290
1123435	4 G 4	13.7	153.6	351
1123436	5 G 4	14.9	192.0	416
1123437	3 G 6	13.9	172.8	377
1123438	4 G 6	15.1	230.4	463
1123439	5 G 6	16.8	288.0	559
1123440	4 G 10	18.7	384.0	757
1123441	5 G 10	20.7	480.0	915
1123442	4 G 16	21.3	614.4	1,070
1123443	5 G 16	23.6	768.0	1,296
1123444	4 G 25	26.2	960.0	1,631

Copper price basis: EUR 150 / 100 kg
Please find our standard lengths at: www.lappkabel.de/en/cable-standardlengths
Packaging size: Coil ≤ 30 kg and ≤ 250 m, otherwise drum
Please specify the desired packaging size (e.g. 1 x 500 m drum or 5 x 100 m coils)

Comparable products

- ÖLFLEX® CLASSIC 110 H see page 24
- ÖLFLEX® CLASSIC 130 H see page 28

Accessories

- SKINTOP® ST-HF-M see page 110



Wide range use

PVC sheath, approved

ÖLFLEX® 140

Standard type H05VV5-F (HD 21.13 S1)



Info

- For CCC (China Compulsory Certification) version please add "C" to the common part number

Application range

- Plant engineering and construction
 - Industrial machinery
 - Air conditioning installations
- Machine tools
- For fixed installation under medium-mechanical load conditions as well as occasional flexing at free, non-continuously recurring movement without tensile load or compulsory guidance

- Increased oil resistance

Approvals (Norm references)



Design

- Fine strands of bare copper wires
- PVC core insulation
- PVC outer sheath, increased oil resistance grey (RAL 7001)

Product features

- Flame retardant according to IEC 60332-1-2

Technical data

- Core identification code**
Black with white numbers acc. to VDE 0293
- Approvals**
HD 21.13 S1
VDE 0281 Teil 13
- Specific insulation resistance**
> 20 GOhm x cm
- Conductor stranding**
Fine wire in accordance to VDE 0295
Class 5 / IEC 60228 Class 5
- Minimum bending radius**
Occasional flexing: 12.5 x cable diameter
Fixed installation: 4 x cable diameter
- Rated voltage**
U_i/U: 300/500 V
- Test voltage**
3000 V
- Protective conductor**
G = with protective conductor GN/YE
X = without protective conductor
- Range of temperature**
Occasional flexing: -5°C up to +70°C
Fixed installation: -40°C up to +70°C

Part number	Number of cores and mm ² per conductor	Outer diameter mm min./max.	Copper index kg/km	Weight kg/km approx.
ÖLFLEX® 140 H05VV5-F				
0011000	3 G 0.50	5.5 - 7.0	14.4	62.4
0011104	4 G 0.50	6.2 - 7.9	19.2	68.2
0011001	5 G 0.50	6.8 - 8.6	24.0	87.1
0011002	7 G 0.50	8.3 - 10.4	33.6	118.7
0011003	12 G 0.50	10.4 - 12.9	58.0	198.0
0011004	18 G 0.50	12.3 - 15.3	86.4	266.9
0011005	25 G 0.50	14.8 - 18.3	120.0	380.4
0011006	34 G 0.50	17.2 - 21.2	163.2	509.0
0011009	3 G 0.75	6.0 - 7.6	21.6	75.6
0011204	4 G 0.75	6.6 - 8.3	28.8	83.9
0011010	5 G 0.75	7.4 - 9.3	36.0	113.3
0011011	7 G 0.75	9.0 - 11.3	50.0	145.0
0011012	12 G 0.75	11.0 - 13.7	86.0	244.9
0011013	18 G 0.75	13.2 - 16.4	130.0	327.7
0011014	25 G 0.75	15.8 - 19.5	180.0	466.4
0011015	34 G 0.75	18.4 - 22.6	245.0	626.5
0011241	41 G 0.75	20.1 - 24.7	296.0	748.0
0011018	3 G 1.00	6.3 - 8.0	28.8	89.3
0011304	4 G 1.00	6.9 - 8.7	38.4	98.6
0011019	5 G 1.00	7.8 - 9.8	48.0	132.1
0011020	7 G 1.00	9.5 - 11.8	67.0	169.3
0011021	12 G 1.00	11.8 - 14.6	115.0	285.9
0011022	18 G 1.00	14.0 - 17.2	173.0	405.2
0011023	25 G 1.00	16.8 - 20.7	240.0	569.5
0011024	34 G 1.00	19.6 - 24.0	326.0	741.7
0011341	41 G 1.00	27.4 - 26.2	394.0	886.0
0011027	3 G 1.50	7.4 - 9.4	43.0	109.8
0011404	4 G 1.50	8.2 - 10.2	58.0	140.7
0011028	5 G 1.50	9.1 - 11.4	72.0	168.0
0011029	7 G 1.50	11.3 - 14.1	101.0	224.2
0011030	12 G 1.50	13.8 - 17.0	173.0	361.7
0011031	18 G 1.50	16.5 - 20.3	259.0	518.3
0011032	25 G 1.50	19.8 - 24.3	360.0	729.9
0011033	34 G 1.50	23.1 - 28.2	490.0	946.6
0011036	3 G 2.50	9.0 - 11.2	72.0	162.4
0011504	4 G 2.50	10.1 - 12.5	96.0	203.3
0011037	5 G 2.50	11.0 - 13.7	120.0	251.1
0011038	7 G 2.50	13.6 - 16.8	168.0	326.0
0011039	12 G 2.50	16.8 - 20.6	288.0	553.3
0011045	14 G 2.50	18.3 - 22.7	336.0	611.0
0011040	18 G 2.50	20.2 - 24.8	432.0	795.2
0011041	25 G 2.50	24.2 - 29.6	600.0	1,109.6

Copper price basis: EUR 150 / 100 kg
 Please find our standard lengths at: www.lappkabel.de/en/cable-standardlengths
 Packaging size: Coil ≤ 30 kg and ≤ 250 m, otherwise drum
 Please specify the desired packaging size (e.g. 1 x 500 m drum or 5 x 100 m coils)

Comparable products

- ÖLFLEX® 150 QUATTRO see page 33

Accessories

- SKINTOP® CLICK see page 109

ÖLFLEX® 140 CY

Standard type H05VVC4V5-K (HD 21.13 S1)



Info

- For CCC (China Compulsory Certification) version please add "C" to the common part number
- EMC compliant

Application range

- Plant engineering and construction
Industrial machinery
Air conditioning installations
- Machine tools
- For fixed installation under medium mechanical load conditions as well as occasional flexing at free, non-continuously recurring movement without tensile load or compulsory guidance
- In EMI critical environment (electromagnetic interference)

Product features

- Flame retardant according to IEC 60332-1-2
- Increased oil resistance

- High coverage degree of the screen
low transfer impedance
(max. 250 Ω/km at 30 MHz)

Approvals (Norm references)



Design

- Fine strands of bare copper wires
- PVC core insulation
- PVC inner sheath, grey
- Screen made of tinned copper wire braid
- PVC outer sheath, increased oil resistance grey (RAL 7001)

Technical data

- Core identification code**
Black with white numbers acc. to VDE 0293
- Approvals**
HD 21.13 S1
VDE 0281 Teil 13
- Specific insulation resistance**
> 20 GOhm x cm
- Conductor stranding**
Fine wire in accordance to VDE 0295
Class 5 / IEC 60228 Class 5
- Minimum bending radius**
Occasional flexing: 20 x cable diameter
Fixed installation: 6 x cable diameter
- Rated voltage**
U₀/U: 300/500 V
- Test voltage**
3000 V
- Protective conductor**
G = with protective conductor GN/YE
X = without protective conductor
- Range of temperature**
Occasional flexing: -5°C up to +70°C
Fixed installation: -40°C up to +70°C

Part number	Number of cores and mm ² per conductor	Outer diameter mm min./max.	Copper index kg/km	Weight kg/km approx.
ÖLFLEX® 140 CY H05VVC4V5-K				
0035700	3 G 0.50	8.0 - 10.0	47.0	111.3
0035701	4 G 0.50	8.5 - 10.7	58.0	132.7
0035702	5 G 0.50	9.3 - 11.6	69.0	162.7
0035703	7 G 0.50	10.8 - 13.5	86.0	207.7
0035704	12 G 0.50	13.1 - 16.2	142.0	295.0
0035710	3 G 0.75	8.3 - 10.4	55.0	129.4
0035711	4 G 0.75	9.1 - 11.3	67.0	163.6
0035712	5 G 0.75	9.7 - 12.1	77.4	188.6
0035713	7 G 0.75	11.5 - 14.3	109.0	246.9
0035714	12 G 0.75	13.8 - 17.1	166.0	354.3
0035715	18 G 0.75	16.1 - 19.8	257.3	517.0
0035716	25 G 0.75	18.7 - 23.0	318.6	677.8
0035717	34 G 0.75	21.4 - 26.2	409.4	860.6
0035720	3 G 1.00	8.8 - 11.0	62.0	144.8
0035721	4 G 1.00	9.4 - 11.7	78.3	180.8
0035722	5 G 1.00	10.3 - 12.8	91.0	209.0
0035723	7 G 1.00	12.2 - 15.1	118.0	273.0
0035724	12 G 1.00	14.5 - 17.9	198.0	427.6
0035725	18 G 1.00	16.9 - 20.8	303.6	598.6
0035726	25 G 1.00	19.8 - 24.2	411.9	791.8
0035727	34 G 1.00	22.6 - 27.7	516.3	1,003.9
0035730	3 G 1.50	9.7 - 12.1	83.0	189.7
0035731	4 G 1.50	10.7 - 13.2	97.8	221.6
0035732	5 G 1.50	11.8 - 14.7	118.0	261.8
0035733	7 G 1.50	14.1 - 17.4	218.0	356.7
0035734	12 G 1.50	16.7 - 20.6	309.7	559.4
0035735	18 G 1.50	19.5 - 24.0	411.4	767.6
0035736	25 G 1.50	22.9 - 28.0	546.5	1,049.0
0035740	3 G 2.50	11.3 - 14.0	115.0	241.5
0035741	4 G 2.50	12.6 - 15.5	163.0	298.3
0035742	5 G 2.50	13.9 - 17.2	191.0	363.7
0035743	7 G 2.50	16.5 - 20.3	288.9	487.2
0035744	12 G 2.50	19.8 - 24.3	516.6	743.6

Copper price basis: EUR 150 / 100 kg
Please find our standard lengths at: www.lappkabel.de/en/cable-standardlengths
Packaging size: Coil ≤ 30 kg and ≤ 250 m, otherwise drum
Please specify the desired packaging size (e.g. 1 x 500 m drum or 5 x 100 m coils)

Comparable products

- ÖLFLEX® 150 CY QUATTRO see page 34

Accessories

- SKINTOP® MS-SC-M see page 114
- SKINTOP® MS-SC-M BRUSH see page 115
- KMK Marking labels



Wide range use

Halogen-free

ÖLFLEX® CLASSIC 135 CH

VDE certified characteristics



Info

- Now with additional flame test acc. to NF C 32-070 categorie C1
- For UL AWM version please add "A" to the common part number

Application range

- Public buildings
- Airport, railway station
- Plant engineering and construction
Industrial machinery
Air conditioning installations
- Particularly where human and animal life as well as valuable property are exposed to high risk of fire hazards
- In EMI critical environment (electromagnetic interference)

- No flame propagation according to NF C 32-070 category C1
- Halogen-free according to IEC 60754-1 (amount of halogen acid gas)
Corrosiveness of combustion gases according to IEC 60754-2 (degree of acidity)
- Low smoke density acc. to IEC 61034

Approvals (Norm references)



Product features

- Flame retardant according to IEC 60332-1-2 (flame spread on single cable)
- No flame propagation acc. to IEC 60332-3-24 respectively IEC 60332-3-25 (Flame spread on vertical cable or wire bundle)

Design

- Fine strands of bare copper wires
- Core insulation: Halogen-free
- Halogen-free plastic foil wrapping
- Screen made of tinned copper wire braid
- Special blended halogen-free outer sheath grey (RAL 7001)

Technical data

- Core identification code**
Black with white numbers acc. to VDE 0293
- Based on**
VDE 0281 Part 14
- Specific insulation resistance**
>10 MΩm x km
- Conductor stranding**
Fine wire in accordance to VDE 0295 Class 5 / IEC 60228 Class 5
- Minimum bending radius**
Occasional flexing: 20 x cable diameter
Fixed installation: 6 x cable diameter
- Rated voltage**
U_c/U: 300/500 V
- Test voltage**
Core/core: 4000 V
Core/screen: 2000 V
- Protective conductor**
G = with protective conductor GN/YE
X = without protective conductor
- Range of temperature**
Occasional flexing: -15°C to +70°C
Fixed installation: -40°C up to +70°C

Part number	Number of cores and mm² per conductor	Outer diameter in mm approx.	Copper index kg/km	Weight kg/km approx.
ÖLFLEX® CLASSIC 135 CH				
1123200	2 X 0.5	5.8	36.0	51
1123201	3 G 0.5	6.1	43.0	61
1123202	3 X 0.5	6.1	43.0	61
1123203	4 G 0.5	6.5	49.0	72
1123204	4 X 0.5	6.5	49.0	72
1123205	5 G 0.5	7.0	57.0	85
1123206	5 X 0.5	7.0	57.0	85
1123208	7 G 0.5	7.6	69.0	103
1123209	7 X 0.5	7.6	69.0	103
1123213	12 G 0.5	9.9	104.0	165
1123217	18 G 0.5	11.6	141.0	236
1123220	25 G 0.5	13.6	224.0	324
1123232	2 X 0.75	6.2	43.0	60
1123233	3 G 0.75	6.5	52.0	77
1123234	3 X 0.75	6.5	52.0	77
1123235	4 G 0.75	7.0	61.0	87
1123236	4 X 0.75	7.0	61.0	87
1123237	5 G 0.75	7.7	72.0	106
1123238	5 X 0.75	7.7	72.0	106
1123241	7 G 0.75	8.3	89.0	129
1123242	7 X 0.75	8.3	89.0	129
1123247	12 G 0.75	10.9	138.0	211
1123248	12 X 0.75	10.9	138.0	211
1123251	18 G 0.75	12.7	211.0	307
1123254	25 G 0.75	15.0	280.0	413
1123266	2 X 1	6.5	51.0	79
1123267	3 G 1	6.8	62.0	88
1123268	3 X 1	6.8	62.0	88
1123269	4 G 1	7.4	74.0	106
1123270	4 X 1	7.4	74.0	106
1123271	5 G 1	8.1	88.0	124
1123272	5 X 1	8.1	88.0	124
1123274	7 G 1	8.8	112.0	155
1123275	7 X 1	8.8	112.0	155
1123280	12 G 1	11.5	185.0	250
1123281	12 X 1	11.5	185.0	250

Part number	Number of cores and mm² per conductor	Outer diameter in mm approx.	Copper index kg/km	Weight kg/km approx.
1123284	18 G 1	13.8	268.0	368
1123290	25 G 1	16.1	354.0	493
1123291	25 X 1	16.1	354.0	493
1123306	2 X 1.5	7.1	65.0	91
1123307	3 G 1.5	7.5	82.0	112
1123308	3 X 1.5	7.5	82.0	112
1123309	4 G 1.5	8.2	100.0	141
1123310	4 X 1.5	8.2	100.0	141
1123311	5 G 1.5	8.9	119.0	161
1123312	5 X 1.5	8.9	119.0	161
1123314	7 G 1.5	9.9	154.0	206
1123315	7 X 1.5	9.9	154.0	206
1123320	12 G 1.5	13.0	268.0	355
1123324	18 G 1.5	15.5	373.0	517
1123328	25 G 1.5	18.1	530.0	705
1123339	2 X 2.5	8.3	96.0	128
1123340	3 G 2.5	9.0	118.0	157
1123342	4 G 2.5	9.9	147.0	201
1123344	5 G 2.5	11.0	176.0	248
1123346	7 G 2.5	11.9	253.0	313
1123349	12 G 2.5	15.5	385.0	524
1123359	3 G 4	10.7	178.0	231
1123360	4 G 4	11.7	248.0	291
1123361	5 G 4	12.9	269.0	361
1123362	7 G 4	14.2	371.0	468
1123366	3 G 6	12.5	240.0	318
1123367	4 G 6	13.9	343.0	437
1123368	5 G 6	15.4	441.0	510
1123369	7 G 6	16.9	510.0	662
1123372	4 G 10	17.4	535.0	685
1123373	5 G 10	19.5	592.0	824
1123374	7 G 10	21.5	820.0	1,067
1123377	4 G 16	20.2	736.0	1,036
1123378	5 G 16	22.6	895.0	1,285
1123381	4 G 25	25.1	1,129.0	1,663
1123382	5 G 25	28.0	1,400.0	1,976
1123385	4 G 35	28.4	1,546.0	2,052

Copper price basis: EUR 150 / 100 kg

Please find our standard lengths at: www.lappkabel.de/en/cable-standardlengths

Packaging size: Coil ≤ 30 kg and ≤ 250 m, otherwise drum

Please specify the desired packaging size (e.g. 1 x 500 m drum or 5 x 100 m coils)

Comparable products

- ÖLFLEX® CLASSIC 110 CH see page 25
- ÖLFLEX® CLASSIC 135 CH BK 0,6/1kV

Accessories

- SKINTOP® MS-SC-M see page 114
- SKINTOP® ST-HF-M see page 110

ÖLFLEX® 150 QUATTRO



Info

- For CCC (China Compulsory Certification) version please add "C" to the common part number



Benefits

- Broad application range due to multiple approvals

Application range

- Plant engineering and construction
Industrial machinery
Air conditioning installations
- Machine tools
- For fixed installation under medium mechanical load conditions as well as occasional flexing at free, non-continuously recurring movement without tensile load or compulsory guidance
- Amendment: Single conductor or multi-conductor Type AWM (Appliance Wiring Material) shall be permitted for industrial machinery (US) when part of a listed assembly suitable for the intended use only. NFPA 79 Edition 2007 §12.2.7.3 (Electrical Standard for Industrial Machinery)

Product features

- Flame retardant according to IEC 60332-1-2 and UL 1581 §1061 Cable Flame Test
- Increased oil resistance

Approvals (Norm references)



Design

- Fine strands of bare copper wires
- PVC core insulation
- PVC outer sheath, increased oil resistance grey (RAL 7001)

Technical data

- Core identification code**
Black with white numbers acc. to VDE 0293
- Approvals**
Standard type H05VV5-F (HD 21.13 S1)
UL AWM Style 21098
CSA AWM I A/B II A/B
- Specific insulation resistance**
> 20 GOhm x cm
- Conductor stranding**
Fine wire in accordance to VDE 0295
Class 5 / IEC 60228 Class 5
- Minimum bending radius**
Occasional flexing: 12.5 x cable diameter
Fixed installation: 4 x cable diameter
- Rated voltage**
HAR U₀/U: 300/500 V
UL/CSA: 600 V
- Test voltage**
3000 V
- Protective conductor**
G = with protective conductor GN/YE
X = without protective conductor
- Range of temperature**
Occasional flexing:
HAR: -5°C up to +70°C
UL/CSA: -5°C up to +90°C
Fixed installation:
HAR: -40°C up to +70°C
UL/CSA: -40°C up to +90°C

Part number	Number of cores and mm² per conductor	AWG	Outer diameter in mm approx.	Copper index kg/km	Weight kg/km approx.
ÖLFLEX® 150 QUATTRO					
0015002	2 X 0.5	21	5.9	9.6	47
0015003	3 G 0.5	21	6.2	14.4	62
0015004	4 G 0.5	21	6.8	19.2	68
0015005	5 G 0.5	21	7.4	24.0	87
0015007	7 G 0.5	21	9.1	33.6	118
0015012	12 G 0.5	21	11.1	58.0	198
0015018	18 G 0.5	21	14.2	86.4	328
0015025	25 G 0.5	21	16.0	120.0	380
0015034	34 G 0.5	21	18.1	164.0	509
0015041	41 G 0.5	21	19.7	197.0	595
0015102	2 X 0.75	19	6.3	14.4	61
0015103	3 G 0.75	19	6.7	21.6	75
0015104	4 G 0.75	19	7.2	28.8	83
0015105	5 G 0.75	19	8.1	36.0	113
0015107	7 G 0.75	19	9.9	50.0	145
0015112	12 G 0.75	19	12.0	86.0	244
0015118	18 G 0.75	19	14.4	130.0	327
0015125	25 G 0.75	19	17.5	180.0	466
0015134	34 G 0.75	19	19.7	245.0	626
0015141	41 G 0.75	19	21.6	296.0	748
0015202	2 X 1	18	6.7	19.2	80
0015203	3 G 1	18	7.1	28.8	89
0015204	4 G 1	18	7.7	38.4	98
0015205	5 G 1	18	8.7	48.0	132
0015206	6 G 1	18	9.7	57.6	150
0015207	7 G 1	18	11.5	67.0	169

Part number	Number of cores and mm² per conductor	AWG	Outer diameter in mm approx.	Copper index kg/km	Weight kg/km approx.
0015212	12 G 1	18	13.0	115.0	285
0015218	18 G 1	18	15.4	173.0	405
0015225	25 G 1	18	18.7	240.0	569
0015234	34 G 1	18	21.3	326.0	741
0015241	41 G 1	18	23.1	394.0	886
0015250	50 G 1	18	25.2	480.0	1,072
0015261	61 G 1	18	28.5	586.0	1,266
0015262	65 G 1	18	28.8	624.0	1,410
0015302	2 X 1.5	16	7.5	28.8	95
0015303	3 G 1.5	16	8.1	43.0	109
0015304	4 G 1.5	16	8.9	58.0	140
0015305	5 G 1.5	16	10.0	72.0	168
0015307	7 G 1.5	16	12.3	101.0	224
0015312	12 G 1.5	16	14.8	173.0	361
0015318	18 G 1.5	16	17.8	259.0	518
0015325	25 G 1.5	16	21.5	360.0	729
0015334	34 G 1.5	16	24.7	490.0	946
0015341	41 G 1.5	16	26.8	591.0	1,136
0015361	61 G 1.5	16	31.4	879.0	1,638
0015402	2 X 2.5	14	8.9	48.0	159
0015403	3 G 2.5	14	9.6	72.0	170
0015404	4 G 2.5	14	10.7	96.0	210
0015405	5 G 2.5	14	11.8	120.0	257
0015407	7 G 2.5	14	14.5	168.0	340
0015412	12 G 2.5	14	17.7	288.0	580
0015418	18 G 2.5	14	21.4	432.0	850
0015425	25 G 2.5	14	25.8	600.0	1,175

Copper price basis: EUR 150 / 100 kg
Please find our standard lengths at: www.lappkabel.de/en/cable-standardlengths
Packaging size: Coil ≤ 30 kg and ≤ 250 m, otherwise drum
Please specify the desired make-up (e.g. 1 x 600 m drum or 8 x 75 m coils)
VDE certification covers the size range up to and including 60 cores

Comparable products

- ÖLFLEX® 140 see page 30
- ÖLFLEX® 191 see page 35

Accessories

- SKINTOP® CLICK see page 109
- SKINTOP® ST-M see page 107



Wide range use

PVC sheath, approved

ÖLFLEX® 150 CY QUATTRO



Info

- For CCC (China Compulsory Certification) version please add "C" to the common part number
- EMC compliant

Benefits

- Broad application range due to multiple approvals

Application range

- Plant engineering and construction
 - Industrial machinery
 - Air conditioning installations
- In EMI critical environment (electromagnetic interference)
- For fixed installation under medium mechanical load conditions as well as occasional flexing at free, non-continuously recurring movement without tensile load or compulsory guidance
- Amendment: Single conductor or multi-conductor Type AWM (Appliance Wiring Material) shall be permitted for industrial machinery (US) when part of a listed assembly suitable for the intended use only. NFPA 79 Edition 2007 §12.2.7.3 (Electrical Standard for Industrial Machinery)

Product features

- Flame retardant according to IEC 60332-1-2 and UL 1581 § 1061 Cable Flame Test
- Increased oil resistance
- High coverage degree of the screen low transfer impedance (max. 250 Ω/km at 30 MHz)

Approvals (Norm references)



Design

- Fine strands of bare copper wires
- PVC core insulation
- PVC inner sheath, grey
- Screen made of tinned copper wire braid
- PVC outer sheath, increased oil resistance grey (RAL 7001)

Technical data

- Core identification code**
Black with white numbers acc. to VDE 0293
- Approvals**
Standard type H05VV4V5-K (HD 21.13 S1)
UL AWM Style 21098
CSA AWM I A/B II A/B
- Specific insulation resistance**
> 20 GΩm x cm
- Conductor stranding**
Fine wire in accordance to VDE 0295
Class 5 / IEC 60228 Class 5
- Minimum bending radius**
Occasional flexing: 20 x cable diameter
Fixed installation: 6 x cable diameter
- Rated voltage**
HAR U₀/U: 300/500 V
UL/CSA: 600 V
- Test voltage**
3000 V
- Protective conductor**
G = with protective conductor GN/YE
X = without protective conductor
- Range of temperature**
Occasional flexing:
HAR: -5°C up to +70°C
UL/CSA: -5°C up to +90°C
Fixed installation:
HAR: -40°C up to +70°C
UL/CSA: -40°C up to +90°C

Part number	Number of cores and mm ² per conductor	AWG	Outer diameter in mm approx.	Copper index kg/km	Weight kg/km approx.
ÖLFLEX® 150 CY QUATTRO					
0015602	2 X 0.75	19	8.5	40.0	109
0015603	3 G 0.75	19	8.9	68.0	125
0015604	4 G 0.75	19	9.6	70.0	157
0015605	5 G 0.75	19	10.3	77.0	180
0015607	7 G 0.75	19	12.3	93.0	226
0015612	12 G 0.75	19	14.4	155.0	325
0015702	2 X 1	18	8.9	46.4	121
0015703	3 G 1	18	9.5	76.0	145
0015704	4 G 1	18	10.1	80.0	180
0015705	5 G 1	18	11.1	95.0	203
0015707	7 G 1	18	13.1	118.0	273
0015712	12 G 1	18	15.8	195.0	425
0015802	2 X 1.5	16	9.9	59.2	151
0015803	3 G 1.5	16	10.3	84.0	159
0015804	4 G 1.5	16	11.3	94.0	211
0015805	5 G 1.5	16	12.6	122.0	241
0015807	7 G 1.5	16	14.9	143.0	306
0015812	12 G 1.5	16	17.6	254.0	480
0015903	3 G 2.5	14	11.8	120.0	245
0015904	4 G 2.5	14	13.1	170.0	295
0015905	5 G 2.5	14	14.6	205.0	365
0015907	7 G 2.5	14	17.3	241.0	480

Copper price basis: EUR 150 / 100 kg

Please find our standard lengths at: www.lappkabel.de/en/cable-standardlengths

Packaging size: Coil ≤ 30 kg and ≤ 250 m, otherwise drum

Please specify the desired make-up (e.g. 1 x 600 m drum or 8 x 75 m coils)

Comparable products

- ÖLFLEX® 140 CY see page 31
- ÖLFLEX® 191 CY see page 36

Accessories

- SKINTOP® MS-SC-M see page 114
- SKINTOP® MS-SC-M BRUSH see page 115



Info

- Conductor cross section up to AWG 4/0 (120mm²)

Benefits

- High electrical performance due to 4kV test voltage
- Wide range of application opportunities

Application range

- Plant engineering and construction
Industrial machinery
Air conditioning installations
- Machine tools
- For fixed installation under medium mechanical load conditions as well as occasional flexing at free, non-continuously recurring movement without tensile load or compulsory guidance
- Amendment: Single conductor or multi-conductor Type AWM (Appliance Wiring Material) shall be permitted for industrial machinery (US) when part of a listed assembly suitable for the intended use only. NFPA 79 Edition 2007 §12.2.7.3 (Electrical Standard for Industrial Machinery)



Product features

- Flame retardant according to IEC 60332-1-2 and UL 1581 §1061 Cable Flame Test
- Increased oil resistance
- Fulfils metrical and AWG specification of conductor cross section

Approvals (Norm references)



Design

- Fine strands of bare copper wires
- PVC core insulation
- PVC outer sheath, increased oil resistance grey (RAL 7001)

Technical data

- Core identification code**
Black with white numbers acc. to VDE 0293
- Approvals**
UL AWM Style 21098
CSA AWM I A/B II A/B
- Specific insulation resistance**
> 20 GOhm x cm
- Conductor stranding**
Fine wire in accordance to VDE 0295
Class 5 / IEC 60228 Class 5
- Minimum bending radius**
Occasional flexing: 15 x cable diameter
Fixed installation: 4 x cable diameter
- Rated voltage**
HAR U₀/U: 300/500 V
UL/CSA: 600 V
- Test voltage**
4000 V
- Protective conductor**
G = with protective conductor GN/YE
X = without protective conductor
- Range of temperature**
Occasional flexing:
HAR: -5°C up to +70°C
UL/CSA: -5°C up to +90 °C
Fixed installation:
HAR: -40°C up to +70°C
UL/CSA: -40°C up to +90°C

Part number	Number of cores and mm ² per conductor	AWG	Outer diameter in mm approx.	Copper index kg/km	Weight kg/km approx.
ÖLFLEX® 191					
0011106	18 G 0.5	21	12.1	86.4	267
0011218	2 X 0.75	19	5.9	14.4	51
0011219	3 G 0.75	19	6.3	21.6	61
0011220	4 G 0.75	19	6.8	28.8	74
0011221	5 G 0.75	19	7.5	36.0	88
0011222	7 G 0.75	19	8.3	50.4	116
0011223	9 G 0.75	19	10.5	64.8	152
0011224	12 G 0.75	19	11.2	86.4	194
0011225	18 G 0.75	19	13.3	129.6	275
0011226	25 G 0.75	19	16.1	180.0	383
0011113	3 G 1	18	6.7	28.8	66
0011114	4 G 1	18	7.2	38.4	81
0011115	5 G 1	18	8.1	48.0	95
0011116	7 G 1	18	8.9	67.2	125
0011117	12 G 1	18	12.0	115.2	211
0011118	18 G 1	18	14.4	172.8	309
0011119	25 G 1	18	17.3	240.0	413
0011136	2 X 1.5	16	6.9	28.8	74
0011137	3 G 1.5	16	7.3	44.0	91
0011138	4 G 1.5	16	8.2	58.0	112
0011139	5 G 1.5	16	9.0	72.0	136
0011140	7 G 1.5	16	10.0	101.0	179
0011125	9 G 1.5	16	12.7	129.6	230
0011142	12 G 1.5	16	13.4	173.0	313

Copper price basis: EUR 150 / 100 kg
Please find our standard lengths at: www.lappkabel.de/en/cable-standardlengths
Packaging size: Coil ≤ 30 kg and ≤ 250 m, otherwise drum
Please specify the desired make-up (e.g. 1 x 600 m drum or 8 x 75 m coils)

Part number	Number of cores and mm ² per conductor	AWG	Outer diameter in mm approx.	Copper index kg/km	Weight kg/km approx.
0011143	18 G 1.5	16	16.1	260.0	444
0011144	25 G 1.5	16	19.5	360.0	620
0011150	3 G 2.5	14	8.4	72.0	138
0011151	4 G 2.5	14	9.1	96.0	182
0011152	5 G 2.5	14	10.2	120.0	216
0011153	7 G 2.5	14	11.4	168.0	286
0011160	3 G 4	12	10.0	115.2	232
0011161	4 G 4	12	10.9	154.0	295
0011162	5 G 4	12	12.2	192.0	354
0011167	7 G 4	12	13.5	268.8	540
0011165	4 G 6	10	13.0	231.0	398
0011166	5 G 6	10	14.5	288.0	479
0011169	4 G 10	8	16.7	384.0	648
0011170	5 G 10	8	18.7	480.0	782
0011172	4 G 16	6	21.4	615.0	1,040
0011173	5 G 16	6	24.1	768.0	1,254
0011175	4 G 25	4	25.6	960.0	1,501
0011176	5 G 25	4	28.8	1,200.0	1,853
0011178	4 G 35	2	28.9	1,344.0	2,119
0011179	5 G 35	2	32.4	1,680.0	2,606
0011205	4 G 50	1	35.7	1,920.0	2,898
0011206	4 G 70	2/0	43.0	2,688.0	4,052
0011207	4 G 95	3/0	47.2	3,648.0	5,430
0011208	4 G 120	4/0	54.2	4,608.0	6,290

Comparable products

- ÖLFLEX® 150 QUATTRO see page 33
- ÖLFLEX® CONTROL TM see page 39
- ÖLFLEX® TRAY II see page 41
- ÖLFLEX® CONTROL M see page 48

Accessories

- SKINTOP® CLICK see page 109
- SKINTOP® ST-M see page 107
- Cable shears KT 4 and KT 5



Wide range use

PVC sheath, approved

ÖLFLEX® 191 CY



Info

- Conductor cross section up to AWG 4/0 (120mm²)
- EMC compliant

Benefits

- High electrical performance due to 4kV test voltage
- Wide range of application opportunities

Application range

- Plant engineering and construction
Industrial machinery
Air conditioning installations
- In EMI critical environment (electromagnetic interference)
- For fixed installation under medium-mechanical load conditions as well as occasional flexing at free, non-continuously recurring movement without tensile load or compulsory guidance
- Amendment: Single conductor or multi-conductor Type AWM (Appliance Wiring Material) shall be permitted for industrial machinery (US) when part of a listed assembly suitable for the intended use only. NFPA 79 Edition 2007 §12.2.7.3 (Electrical Standard for Industrial Machinery)

Product features

- Flame retardant according to IEC 60332-1-2 and UL 1581 §1061 Cable Flame Test
- Increased oil resistance
- High coverage degree of the screen low transfer impedance (max. 250 Ω/km at 30 MHz)

Approvals (Norm references)



Design

- Fine strands of bare copper wires
- PVC core insulation
- PVC inner sheath, grey
- Screen made of tinned copper wire braid
- PVC outer sheath, increased oil resistance grey (RAL 7001)

Technical data

- Core identification code**
Black with white numbers acc. to VDE 0293
- Approvals**
UL AWM Style 21098
CSA AWM I A/B II A/B
- Specific insulation resistance**
> 20 GΩm x cm
- Conductor stranding**
Fine wire in accordance to VDE 0295 Class 5 / IEC 60228 Class 5
- Minimum bending radius**
Occasional flexing: 20 x cable diameter
Fixed installation: 6 x cable diameter
- Rated voltage**
HAR U₀/U: 300/500 V
UL/CSA: 600 V
- Test voltage**
4000 V
- Protective conductor**
G = with protective conductor GN/YE
X = without protective conductor
- Range of temperature**
Occasional flexing:
HAR: -5°C up to +70°C
UL/CSA: -5°C up to +90 °C
Fixed installation:
HAR: -40°C up to +70°C
UL/CSA: -40°C up to +90°C

Part number	Number of cores and mm ² per conductor	AWG	Outer diameter in mm approx.	Copper index kg/km	Weight kg/km approx.
ÖLFLEX® 191 CY					
3023436	3 G 0.5	21	7.9	46.9	122
3025753	4 G 0.5	21	9.0	47.4	162
0011230	2 X 0.75	19	8.1	38.4	102
0011231	3 G 0.75	19	8.5	47.2	115
0011232	4 G 0.75	19	9.0	55.8	131
0011233	5 G 0.75	19	9.9	66.4	155
0011234	7 G 0.75	19	10.5	85.9	187
0011235	12 G 0.75	19	14.0	145.0	312
0011236	18 G 0.75	19	16.1	198.3	413
0011237	25 G 0.75	19	18.9	261.5	548
0011202	2 X 1	18	8.0	48.0	126
0011180	3 G 1	18	8.4	55.8	122
0011181	4 G 1	18	9.6	80.8	157
0011182	5 G 1	18	10.1	89.4	183
0011183	7 G 1	18	10.7	99.9	207
0011184	12 G 1	18	14.6	175.7	342
0011185	18 G 1	18	16.5	241.7	472
0011186	25 G 1	18	19.2	341.7	648
0011302	2 X 1.5	16	8.9	64.7	156
0011187	3 G 1.5	16	9.3	89.1	166
0011188	4 G 1.5	16	10.1	96.6	191
0011189	5 G 1.5	16	11.0	111.2	222
0011190	7 G 1.5	16	11.8	145.2	270

Part number	Number of cores and mm ² per conductor	AWG	Outer diameter in mm approx.	Copper index kg/km	Weight kg/km approx.
0011191	12 G 1.5	16	16.0	257.0	464
0011192	18 G 1.5	16	18.8	382.8	679
0011193	25 G 1.5	16	22.9	546.2	952
0011194	3 G 2.5	14	10.9	111.1	221
0011195	4 G 2.5	14	11.9	140.6	269
0011196	5 G 2.5	14	12.9	167.3	325
0011197	7 G 2.5	14	14.1	240.0	421
30010542	12 G 2.5	14	19.3	414.9	769
30010543	18 G 2.5	14	23.9	626.1	1,102
30010544	4 G 4	12	13.6	236.7	462
30010545	5 G 4	12	16.7	277.8	535
30010546	7 G 4	12	18.6	393.4	735
30010548	4 G 6	10	16.9	317.1	574
3023130	5 G 6	10	19.0	413.7	737
30010547	7 G 6	10	20.7	563.8	950
3023131	4 G 10	8	21.0	550.4	946
30010639	4 G 16	6	29.6	819.1	1,660
3023132	4 G 25	4	32.0	1,165.0	2,047
30010928	4 G 35	2	36.7	1,683.0	3,261
3026535	4 G 50	1	42.0	2,342.0	3,362
3025946	4 G 70	2/0	47.4	3,229.0	4,490
3025947	4 G 95	3/0	50.0	4,010.0	5,540
3026536	4 G 120	4/0	56.6	5,012.0	6,960

Copper price basis: EUR 150 / 100 kg
Please find our standard lengths at: www.lappkabel.de/en/cable-standardlengths
Packaging size: Coil ≤ 30 kg and ≤ 250 m, otherwise drum
Please specify the desired make-up (e.g. 1 x 600 m drum or 8 x 75 m coils)

Comparable products

- ÖLFLEX® 150 CY QUATTRO see page 34
- ÖLFLEX® CONTROL TM CY see page 40
- ÖLFLEX® TRAY II CY see page 42

Accessories

- SKINTOP® MS-SC-M see page 114
- SKINTOP® MS-SC-M BRUSH see page 115
- Cable shears KT 4 and KT 5

ÖLFLEX® ROBUST 200



Info

- Robust and weatherproofed
- High chemical resistance

Benefits

- Wide range of application opportunities

Application range

- Machine tool manufacture, medical technology, laundries, car washing equipment, chemical industry, composting plants, sewage works
- Food and beverage industry, especially for production- and processing equipment of milk and meat products
- In environment where exposed to oils, fats, waxes (vegetable- or animal-based or synthetic) or their emulsions
- For indoor and outdoor use

Product features

- Halogen free materials



- High dielectric strength and low mutual capacitance

- Good resistance to hot and cold water as well as to water-soluble cleaning agents (tensides, soaps,...)

- UV resistant and weather proof
- Flexible down to -40 °C

Approvals (Norm references)



Design

- Fine strands of bare copper wires
- Core insulation: TPE, halogen-free
- Cores twisted in layers in short lay lengths
- Robust outer sheath made of special halogen-free TPE, black (RAL 9005)

Technical data

Core identification code
Up to 5 cores: According to VDE 0293-308 Appendix T9)
Starting at 6 cores: Black with white numbers

Based on
HD 22.10 (VDE 0282 Part 10)

Specific insulation resistance
> 20 GOhm x cm

Conductor stranding
Fine wire in accordance to VDE 0295 Class 5 / IEC 60228 Class 5

Minimum bending radius
Occasional flexing: 10 x cable diameter
Fixed installation: 4 x cable diameter

Rated voltage
U₀/U: 450/750 V

Test voltage
4000 V

Protective conductor
G = with protective conductor GN/YE
X = without protective conductor

Range of temperature
Occasional flexing: -40°C up to +80°C
Fixed installation: -50°C up to +80°C

Part number	Number of cores and mm ² per conductor	Outer diameter in mm approx.	Copper index kg/km	Weight kg/km approx.
ÖLFLEX® ROBUST 200				
0021800	2 X 1	8.0	19.2	65
0021801	3 G 1	8.4	29.0	79
0021802	4 G 1	9.2	38.4	96
0021803	5 G 1	10.0	48.0	113
0021805	2 X 1.5	8.6	29.0	78
0021806	3 G 1.5	9.1	43.0	97
0021807	4 G 1.5	9.9	58.0	122
0021808	5 G 1.5	10.8	72.0	146
0021809	7 G 1.5	13.5	101.0	208
0021810	2 X 2.5	9.8	48.0	114
0021811	3 G 2.5	10.4	72.0	144
0021812	4 G 2.5	11.5	96.0	181
0021813	5 G 2.5	13.1	120.0	222
0021814	7 G 2.5	15.9	168.0	312
0021816	3 G 4	12.4	115.2	215
0021817	4 G 4	14.0	154.0	273
0021818	5 G 4	15.8	192.0	333
0021822	4 G 6	15.7	230.0	378
0021823	5 G 6	17.2	288.0	463
0021825	4 G 10	19.4	384.0	633
0021826	5 G 10	21.4	480.0	770
0021828	4 G 16	22.4	614.0	885
0021829	5 G 16	24.6	768.0	1,100
0021831	4 G 25	27.0	960.0	1,365
0021833	4 G 35	29.7	1,344.0	1,773
0021836	4 G 50	36.2	1,920.0	3,454

Copper price basis: EUR 150 / 100 kg
Please find our standard lengths at: www.lappkabel.de/en/cable-standardlengths
Packaging size: Coil ≤ 30 kg and ≤ 250 m, otherwise drum
Please specify the desired packaging size (e.g. 1 x 500 m drum or 5 x 100 m coils)
Single lengths for sizes: ≥ 4G16 max. 600m; ≥ 4G25 max. 300m; ≥ 4G50 max. 250m

Comparable products

- ÖLFLEX® ROBUST 210 see page 38
- ÖLFLEX® ROBUST 215 C see page 43
- ÖLFLEX® FD ROBUST
- ÖLFLEX® FD ROBUST C

Accessories

- Stainless steel - Box Starter - Set
- SKINTOP® MS-M see page 113
- SKINTOP® ST-HF-M see page 110



Harsh use conditions

Increased mechanical and chemical resistance

ÖLFLEX® ROBUST 210



Benefits

- Wide range of application opportunities

Application range

- Machine tool manufacture, medical technology, laundries, car washing equipment, chemical industry, composting plants, sewage works
- Food and beverage industry, especially for production- and processing equipment of milk and meat products
- In environment where exposed to oils, fats, waxes (vegetable- or animal-based or synthetic) or their emulsions
- For indoor and outdoor use

Product features

- Halogen free materials

- High dielectric strength and low mutual capacitance
- Good resistance to hot and cold water as well as to water-soluble cleaning agents (tensides, soaps,...)
- UV resistant and weather proof
- Flexible down to -40 °C

Approvals (Norm references)



Design

- Fine strands of bare copper wires
- Core insulation: TPE, halogen-free
- Cores twisted in layers in short lay lengths
- Robust outer sheath made of special halogen-free TPE, black (RAL 9005)

Technical data

- Core identification code**
Black with white numbers acc. to VDE 0293
- Based on**
VDE 0250/0281
- Specific insulation resistance**
> 20 GOhm x cm
- Conductor stranding**
Fine wire in accordance to VDE 0295
Class 5 / IEC 60228 Class 5
- Minimum bending radius**
Occasional flexing: 15 x cable diameter
Fixed installation: 4 x cable diameter
- Rated voltage**
U₀/U: 300/500 V
- Test voltage**
4000 V
- Protective conductor**
G = with protective conductor GN/YE
X = without protective conductor
- Range of temperature**
Occasional flexing: -40°C up to +80°C
Fixed installation: -50°C up to +80°C

Part number	Number of cores and mm² per conductor	Outer diameter in mm approx.	Copper index kg/km	Weight kg/km approx.
ÖLFLEX® ROBUST 210				
0021880	2 X 0.5	4.9	10.0	27
0021881	3 G 0.5	5.2	15.0	33
0021882	3 X 0.5	5.2	15.0	33
0021883	4 G 0.5	5.8	19.2	41
0021884	4 X 0.5	5.8	19.2	41
0021885	5 G 0.5	6.3	24.0	49
0021886	5 X 0.5	6.3	24.0	49
0021888	7 G 0.5	6.9	33.6	64
0021889	7 X 0.5	6.9	33.6	64
0021890	10 G 0.5	8.8	48.0	92
0021891	12 G 0.5	9.1	58.0	106
0021892	18 G 0.5	10.8	86.4	151
0021893	25 G 0.5	12.7	120.0	210
0021897	2 X 0.75	5.5	14.4	35
0021898	3 G 0.75	5.8	21.6	44
0021899	3 X 0.75	5.8	21.6	44
0021900	4 G 0.75	6.3	28.8	54
0021901	4 X 0.75	6.3	28.8	54
0021902	5 G 0.75	6.9	36.0	65
0021903	5 X 0.75	6.9	36.0	65
0021904	7 G 0.75	7.5	50.0	85
0021905	7 X 0.75	7.5	50.0	85
0021907	12 G 0.75	10.1	86.0	144
0021908	18 G 0.75	12.0	130.0	208
0021909	25 G 0.75	14.1	180.0	288
0021910	34 G 0.75	16.3	245.0	386
0021911	41 G 0.75	17.8	296.0	464
0021912	50 G 0.75	19.6	360.0	560
0021913	2 X 1	5.8	19.2	42
0021914	3 G 1	6.1	28.8	53
0021915	3 X 1	6.1	28.8	53
0021916	4 G 1	6.6	38.4	66
0021917	4 X 1	6.6	38.4	66
0021918	5 G 1	7.3	48.0	80
0021919	5 X 1	7.3	48.0	80
0021920	7 G 1	8.1	67.0	107
0021921	10 G 1	10.4	96.0	154

Part number	Number of cores and mm² per conductor	Outer diameter in mm approx.	Copper index kg/km	Weight kg/km approx.
0021922	12 G 1	10.7	115.0	178
0021923	18 G 1	12.9	173.0	262
0021924	25 G 1	15.0	240.0	357
0021925	34 G 1	17.5	326.0	484
0021926	41 G 1	19.2	394.0	582
0021927	50 G 1	21.0	480.0	703
0021928	2 X 1.5	6.4	29.0	56
0021929	3 G 1.5	6.8	43.0	72
0021930	3 X 1.5	6.8	43.0	72
0021931	4 G 1.5	7.4	58.0	91
0021932	4 X 1.5	7.4	58.0	91
0021933	5 G 1.5	8.3	72.0	112
0021934	5 X 1.5	8.3	72.0	112
0021936	7 G 1.5	9.0	101.0	149
0021937	7 X 1.5	9.0	101.0	149
0021938	10 G 1.5	11.8	143.0	215
0021940	12 G 1.5	12.2	173.0	251
0021941	18 G 1.5	14.6	259.0	369
0021942	25 G 1.5	17.2	360.0	510
0021943	34 G 1.5	19.8	490.0	683
0021945	50 G 1.5	24.0	720.0	999
0021946	2 X 2.5	7.6	48.0	86
0021947	3 G 2.5	8.3	72.0	115
0021949	4 G 2.5	9.0	96.0	144
0021951	5 G 2.5	10.1	120.0	178
0021953	7 G 2.5	11.2	168.0	241
0021954	12 G 2.5	15.1	288.0	405
0021963	3 G 4	10.1	115.0	180
0021964	4 G 4	11.1	157.0	228
0021965	5 G 4	12.4	192.0	280
0021966	7 G 4	13.6	269.0	377
0021967	4 G 6	13.3	230.0	332
0021968	5 G 6	14.8	288.0	407
0021969	4 G 10	16.5	384.0	541
0021970	5 G 10	18.4	480.0	664
0021971	4 G 16	18.8	614.0	806
0021972	4 G 25	23.5	960.0	1,218
0021973	4 G 35	26.4	1,344.0	1,658

Copper price basis: EUR 150 / 100 kg

Please find our standard lengths at: www.lappkabel.de/en/cable-standardlengths

Packaging size: Coil ≤ 30 kg and ≤ 250 m, otherwise drum

Please specify the desired packaging size (e.g. 1 x 500 m drum or 5 x 100 m coils)

Single lengths for sizes: ≥ 4G16 max. 600m; ≥ 4G25 max. 300m; ≥ 4G50 max. 250m

Comparable products

- ÖLFLEX® ROBUST 200 see page 37
- ÖLFLEX® ROBUST 215 C see page 43
- ÖLFLEX® FD ROBUST
- ÖLFLEX® FD ROBUST C

Accessories

- Stainless steel - Box Starter - Set
- SKINTOP® MS-M see page 113
- SKINTOP® ST-HF-M see page 110

ÖLFLEX® CONTROL TM



Info

- According to NFPA 79 Edition 2007 "Electrical Standard for Industrial Machinery" USA

Benefits

- Broad application range due to multiple approvals
- CE-compliant usage in Europe due to metric adapted sizes of the AWG conductors
- Cost saving, easy installation due to re-noucement of closed raceways (suitable for open wiring)

Application range

- Industrial machinery; plant engineering
- Machine tools UL MTW (Machine Tool Wiring) conforming
- TC-ER (Tray Cable Exposed Run) approval for open wiring between cable tray and industrial machines/plants acc. to NEC 336.10(7)
- Wind Turbines: USA Wind Turbine Tray Cable (WTTC)
- Class 1, Div. 2 per NEC "National Electrical Code" Art. 336, 392, 501

Product features

- Flame retardant according to CSA FT4 UL Vertical-Tray Flame Test
- Oil resistant according to UL OIL RES I
- Water resistant UL Wet Approval 75 °C

Approvals (Norm references)



Design

- Finely stranded bare copper wires metric adapted AWG sizes
- Core insulation: PVC with nylon jacket (PA skin)
- Special blended PVC outer sheath, grey (RAL 7001)

Technical data

Core identification code
Black cores with white numbers

Approvals
UL MTW and UL TC-ER
c(UL) Type TC and CIC FT4
UL/CSA AWM I/II A/B FT4
NOM (Normas Oficiales Mexicanas)

Specific insulation resistance
> 20 GOhm x cm

Conductor stranding
Finely stranded bare copper wires
metric adapted AWG sizes

Minimum bending radius
6 x cable diameter

Rated voltage
UL/CSA: 600 V (TC, MTW, CIC), WTTC 1000V
UL/CSA: 1000 V (AWM)
HAR U₀/U: 300/500 V

Test voltage
2000 V

Protective conductor
G = with protective conductor GN/YE
X = without protective conductor

Range of temperature
Occasional flexing: -5°C to +90°C
(AWM +105°C)
Fixed installation: -40°C up to +90 °C
(AWM +105°C)

Part number	Number of cores and mm ² per conductor	AWG	Outer diameter in mm approx.	Copper index kg/km	Weight kg/km approx.
ÖLFLEX® CONTROL TM					
281803	3 G 1	18	7.4	28.8	82
281804	4 G 1	18	8.0	38.4	95
281805	5 G 1	18	8.6	48.0	112
281807	7 G 1	18	9.3	67.0	144
281812	12 G 1	18	12.0	115.0	247
281818	18 G 1	18	14.9	173.0	365
281825	25 G 1	18	16.7	240.0	464
281602	2 X 1.5	16	7.3	28.8	74
281603	3 G 1.5	16	8.1	43.0	100
281604	4 G 1.5	16	8.8	58.0	119
281605	5 G 1.5	16	9.5	72.0	141
281607	7 G 1.5	16	10.3	101.0	183
281609	9 G 1.5	16	11.9	129.6	247
281612	12 G 1.5	16	14.2	173.0	328
281618	18 G 1.5	16	16.2	259.0	403
281625	25 G 1.5	16	18.6	360.0	464
281403	3 G 2.5	14	9.1	72.0	125
281404	4 G 2.5	14	9.8	96.0	155
281405	5 G 2.5	14	10.7	120.0	185
281407	7 G 2.5	14	11.6	168.0	244
281203	3 G 4	12	10.6	115.0	135
281204	4 G 4	12	11.5	154.0	220
281205	5 G 4	12	12.6	192.0	269
281207	7 G 4	12	14.6	269.0	482
281004	4 G 6	10	14.5	231.0	382
281005	5 G 6	10	15.8	288.0	457
280804	4 G 10	8	19.5	384.0	615
280805	5 G 10	8	22.6	480.0	771
280604	4 G 16	6	22.8	615.0	864

Copper price basis: EUR 150 / 100 kg
Please find our standard lengths at: www.lappkabel.de/en/cable-standardlengths
Packaging size: Coil ≤ 30 kg and ≤ 250 m, otherwise drum
Please specify the desired make-up (e.g. 1 x 610 m drum or 8 x 76 m coils)

Comparable products

- ÖLFLEX® TRAY II see page 41
- ÖLFLEX® CONTROL M see page 48

Accessories

- SKINTOP® MS-M see page 113
- SKINTOP® ST-M see page 107



Wide range use

PVC sheath, approved

New

ÖLFLEX® CONTROL TM CY

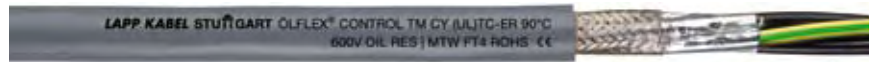

Info

- According to NFPA 79 Edition 2007 "Electrical Standard for Industrial Machinery" USA
- EMC compliant

Benefits

- Broad application range due to multiple approvals
- CE-compliant usage in Europe due to metric adapted sizes of the AWG conductors
- Cost saving, easy installation due to renouncement of closed raceways (suitable for open wiring)

Application range

- Industrial machinery; plant engineering
- Machine tools UL MTW (Machine Tool Wiring) conforming
- TC-ER (Tray Cable Exposed Run) approval for open wiring between cable tray and industrial machines/plants acc. to NEC 336.10(7)
- Wind Turbines: USA Wind Turbine Tray Cable (WTTC)
- Class 1, Div. 2 per NEC "National Electrical Code" Art. 336, 392, 501

Product features

- Flame retardant according to CSA FT4 UL Vertical-Tray Flame Test
- Oil resistant according to UL OIL RES I
- Water resistant UL Wet Approval 75 °C
- High coverage degree of the screen low transfer impedance (max. 250 Ω/km at 30 MHz)

Approvals (Norm references)



Design

- Finely stranded bare copper wires metric adapted AWG sizes
- Core insulation: PVC with nylon jacket (PA skin)
- Aluminum-plated foil
- Screen made of tinned copper wire braid
- Special blended PVC outer sheath, grey (RAL 7001)

Technical data

- Core identification code**
Black cores with white numbers
- Approvals**
UL MTW and UL TC-ER
c(UL) Type TC and CIC FT4
UL/CSA AWM I/II A/B FT4
NOM (Normas Oficiales Mexicanas)
- Specific insulation resistance**
> 20 GOhm x cm
- Conductor stranding**
Finely stranded bare copper wires metric adapted AWG sizes
- Minimum bending radius**
Fixed installation: 6 x cable diameter
- Rated voltage**
UL/CSA: 600 V (TC, MTW, CIC), WTTC 1000V
UL/CSA: 1000 V (AWM)
HAR U_o/U: 300/500 V
- Test voltage**
2000 V
- Protective conductor**
G = with protective conductor GN/YE
X = without protective conductor
- Range of temperature**
Occasional flexing: -5 °C to + 90 °C (AWM +105 °C)
Fixed installation: -40 °C up to +90 °C (AWM +105 °C)

Part number	Number of cores and mm ² per conductor	AWG	Outer diameter in mm approx.	Copper index kg/km	Weight kg/km approx.
ÖLFLEX® CONTROL TM CY					
281803CY	3 G 1	18	8.1	49.5	119
281804CY	4 G 1	18	8.6	60.2	137
281805CY	5 G 1	18	9.3	81.4	149
281807CY	7 G 1	18	10.0	101.1	193
281812CY	12 G 1	18	12.8	161.4	330
281818CY	18 G 1	18	15.5	228.2	438
281825CY	25 G 1	18	17.5	326.4	574
281602CY	2 X 1.5	16	8.3	49.7	115
281603CY	3 G 1.5	16	8.8	65.0	144
281604CY	4 G 1.5	16	9.4	81.9	173
281605CY	5 G 1.5	16	10.2	99.1	189
281607CY	7 G 1.5	16	11.1	140.4	246
281612CY	12 G 1.5	16	15.0	225.2	426
281618CY	18 G 1.5	16	17.2	321.7	552
281625CY	25 G 1.5	16	19.4	453.6	750
281403CY	3 G 2.5	14	9.7	105.7	180
281404CY	4 G 2.5	14	10.4	135.6	223
281405CY	5 G 2.5	14	11.5	160.3	268
281407CY	7 G 2.5	14	12.4	213.0	327
281204CY	4 G 4	12	12.3	198.5	315
281205CY	5 G 4	12	14.2	242.7	388
281207CY	7 G 4	12	15.3	323.4	499
281004CY	4 G 6	10	15.3	284.6	552
281005CY	5 G 6	10	16.7	348.8	613
280804CY	4 G 10	8	18.5	458.4	857
280604CY	4 G 16	6	22.9	723.6	1,208

Copper price basis: EUR 150 / 100 kg
 Please find our standard lengths at: www.lappkabel.de/en/cable-standardlengths
 Packaging size: Coil ≤ 30 kg and ≤ 250 m, otherwise drum
 Please specify the desired make-up (e.g. 1 x 610 m drum or 8 x 76 m coils)

Comparable products

- ÖLFLEX® TRAY II CY see page 42

Accessories

- SKINTOP® MS-SC-M see page 114

ÖLFLEX® TRAY II



Info

- According to NFPA 79 Edition 2007 "Electrical Standard for Industrial Machinery" USA

Benefits

- Broad application range due to multiple approvals
- Cost saving, easy installation due to re-noucement of closed raceways (suitable for open wiring)

Application range

- Industrial machinery; plant engineering
- TC-ER (Tray Cable Exposed Run) approval for open wiring between cable tray and industrial machines/plants acc. to NEC 336.10(7)
- Wind Turbines: USA Wind Turbine Tray Cable (WTTC)
- Class 1, Div. 2 per NEC "National Electrical Code" Art. 336, 392, 501
- Outdoor use suitable

Product features

- Flame retardant according to CSA FT4 UL Vertical-Tray Flame Test
- Oil resistant according to UL OIL RES I
- Water resistant UL Wet Approval 75 °C
- UV resistant UL SUN RES

Approvals (Norm references)



Design

- Fine strands of bare copper wires
- Core insulation: PVC with nylon jacket (PA skin)
- Special blended PVC outer sheath, black (RAL 9005)

Technical data

Core identification code
Black cores with white numbers

Approvals
UL MTW and UL TC-ER
c(UL) Type TC and CIC FT4
UL/CSA AWM I/II A/B FT4
NOM (Normas Oficiales Mexicanas)

Specific insulation resistance
> 20 GOhm x cm

Conductor stranding
Fine copper wire strands

Minimum bending radius
5 x cable diameter

Rated voltage
UL/CSA: 600 V (TC, MTW, CIC), WTTC 1000V
UL/CSA: 1000 V (AWM)
HAR U_o/U: 300/500 V

Test voltage
2000 V

Protective conductor
G = with protective conductor GN/YE
X = without protective conductor

Range of temperature
Fixed installation: -25°C up to +90°C

Part number	Number of cores and AWG per conductor	mm ²	Outer diameter in mm approx.	Copper index kg/km	Weight kg/km approx.
ÖLFLEX® Tray II					
221803	3GAWG18	1.0	7.5	28.8	85.0
221804	4GAWG18	1.0	8.1	38.4	98.0
221805	5GAWG18	1.0	8.9	48.0	115.0
221807	7GAWG18	1.0	9.5	67.0	149.0
221809	9GAWG18	1.0	11.1	87.0	167.0
221812	12GAWG18	1.0	12.1	115.0	255.0
221818	18GAWG18	1.0	14.8	173.0	365.0
221825	25GAWG18	1.0	17.0	240.0	479.0
221603	3GAWG16	1.5	8.1	43.0	103.0
221604	4GAWG16	1.5	8.7	58.0	124.0
221605	5GAWG16	1.5	9.5	72.0	146.0
221607	7GAWG16	1.5	10.2	101.0	189.0
221608	8GAWG16	1.5	11.0	116.0	203.0
221609	9GAWG16	1.5	11.8	130.0	255.0
221612	12GAWG16	1.5	13.3	173.0	328.0
221618	18GAWG16	1.5	16.2	259.0	431.0
221625	25GAWG16	1.5	18.7	360.0	592.0
221641	41GAWG16	1.5	24.5	591.0	931.0
221650	50GAWG16	1.5	26.7	720.0	1,132.0
221403	3GAWG14	2.5	8.8	72.0	130.0
221404	4GAWG14	2.5	9.6	96.0	159.0
221405	5GAWG14	2.5	10.4	120.0	191.0
221407	7GAWG14	2.5	11.3	168.0	252.0
221409	9GAWG14	2.5	13.1	216.0	335.0
221412	12GAWG14	2.5	15.5	288.0	459.0
221418	18GAWG14	2.5	17.8	432.0	654.0
221425	25GAWG14	2.5	20.5	600.0	874.0
221204	4GAWG12	4.0	11.4	153.0	226.0
221205	5GAWG12	4.0	12.5	192.0	279.0
221207	7GAWG12	4.0	14.5	269.0	384.0
221004	4GAWG10	6.0	15.1	231.0	394.0
221005	5GAWG10	6.0	16.5	288.0	472.0
221007	7GAWG10	6.0	17.9	405.0	661.0
220804	4GAWG8	10.0	19.5	384.0	615.0
220805	5GAWG8	10.0	22.6	480.0	771.0
220604	4GAWG6	16.0	22.8	615.0	864.0
220605	5GAWG6	16.0	24.9	768.0	1,080.0
220404	4GAWG4	25.0	27.7	960.0	1,418.0
220204	4GAWG2	35.0	32.0	1,344.0	2,077.0

Copper price basis: EUR 150 / 100 kg
Please find our standard lengths at: www.lappkabel.de/en/cable-standardlengths
Packaging size: Coil ≤ 30 kg and ≤ 250 m, otherwise drum
Please specify the desired make-up (e.g. 1 x 610 m drum or 8 x 76 m coils)

Comparable products

- ÖLFLEX® CONTROL TM see page 39
- ÖLFLEX® CONTROL M see page 48

Accessories

- SKINTOP® MS-M see page 113
- SKINTOP® ST-M see page 107



Wide range use

PVC sheath, approved

ÖLFLEX® TRAY II CY



Info

- According to NFPA 79 Edition 2007 "Electrical Standard for Industrial Machinery" USA
- EMC compliant

Benefits

- Broad application range due to multiple approvals
- Cost saving, easy installation due to re-noucement of closed raceways (suitable for open wiring)

- Oil resistant according to UL OIL RES I
- Water resistant UL Wet Approval 75 °C
- UV resistant UL SUN RES

Approvals (Norm references)



Application range

- Industrial machinery; plant engineering
- TC-ER (Tray Cable Exposed Run) approval for open wiring between cable tray and industrial machines/plants acc. to NEC 336.10(7)
- Wind Turbines: USA Wind Turbine Tray Cable (WTTC)
- Class 1, Div. 2 per NEC "National Electrical Code" Art. 336, 392, 501
- Outdoor use suitable

Design

- Fine strands of bare copper wires
- Core insulation: PVC with nylon jacket (PA skin)
- Aluminum-plated foil
- Screen made of tinned copper wire braid
- Special blended PVC outer sheath, black (RAL 9005)

Product features

- Flame retardant according to CSA FT4 UL Vertical-Tray Flame Test

Technical data

Core identification code
Black cores with white numbers

Approvals
UL MTW and UL TC-ER
c(UL) Type TC and CIC FT4
UL/CSA AWM I/II A/B FT4
NOM (Normas Oficiales Mexicanas)

Specific insulation resistance
> 20 GOhm x cm

Conductor stranding
Fine copper wire strands

Minimum bending radius
5 x cable diameter

Rated voltage
UL/CSA: 600 V (TC, MTW, CIC), WTTC 1000V
UL/CSA: 1000 V (AWM)
HAR U_o/U: 300/500 V

Test voltage
2000 V

Protective conductor
G = with protective conductor GN/YE
X = without protective conductor

Range of temperature
Fixed installation: -25°C up to +90°C

Part number	Number of cores and AWG per conductor	mm ²	Outer diameter in mm approx.	Copper index kg/km	Weight kg/km approx.
ÖLFLEX® Tray II CY					
2218030	3GAWG18	1.0	8.2	35.1	119.0
2218040	4GAWG18	1.0	8.8	55.2	137.0
2218050	5GAWG18	1.0	9.4	65.8	149.0
2218070	7GAWG18	1.0	10.1	86.9	193.0
2218120	12GAWG18	1.0	12.9	149.3	330.0
2218180	18GAWG18	1.0	15.6	214.2	438.0
2218250	25GAWG18	1.0	17.9	354.2	574.0
2216030	3GAWG16	1.5	8.8	59.8	144.0
2216040	4GAWG16	1.5	9.5	74.5	173.0
2216050	5GAWG16	1.5	10.2	93.5	189.0
2216070	7GAWG16	1.5	11.1	130.5	246.0
2216120	12GAWG16	1.5	14.1	213.8	426.0
2216180	18GAWG16	1.5	17.0	312.4	515.0
2216250	25GAWG16	1.5	19.5	415.6	708.0
2214030	3GAWG14	2.5	9.5	91.2	180.0
2214040	4GAWG14	2.5	10.4	125.7	223.0
2214050	5GAWG14	2.5	11.2	150.1	268.0
2214070	7GAWG14	2.5	12.1	201.2	327.0
2214120	12GAWG14	2.5	16.3	333.6	595.0
2214180	18GAWG14	2.5	18.6	487.6	784.0
2214250	25GAWG14	2.5	21.4	685.1	1,048.0
2212040	4GAWG12	4.0	12.2	186.4	315.0
2212050	5GAWG12	4.0	13.3	232.6	388.0
2212070	7GAWG12	4.0	15.3	310.2	499.0
2210040	4GAWG10	6.0	15.9	271.7	552.0
2210070	7GAWG10	6.0	18.8	457.4	856.0
2208040	4GAWG8	10.0	20.3	438.6	857.0
2206040	4GAWG6	16.0	23.6	699.0	1,208.0
2204040	4GAWG4	25.0	28.8	1,296.8	1,982.0
2202040	4GAWG2	35.0	33.3	1,899.5	2,903.0

Copper price basis: EUR 150 / 100 kg
 Please find our standard lengths at: www.lappkabel.de/en/cable-standardlengths
 Packaging size: Coil ≤ 30 kg and ≤ 250 m, otherwise drum
 Please specify the desired make-up (e.g. 1 x 610 m drum or 8 x 76 m coils)

Comparable products

- ÖLFLEX® CONTROL TM CY see page 40

Accessories

- SKINTOP® MS-SC-M see page 114

ÖLFLEX® ROBUST 215 C



Info

- Robust and weatherproofed
- High chemical resistance
- EMC compliant

Benefits

- Wide range of application opportunities

Application range

- Machine tool manufacture, medical technology, laundries, car washing equipment, chemical industry, composting plants, sewage works
- Food and beverage industry, especially for production- and processing equipment of milk and meat products
- In environment where exposed to oils, fats, waxes (vegetable- or animal-based or synthetic) or their emulsions
- For indoor and outdoor use
- In EMI critical environment (electromagnetic interference)

Product features

- Halogen free materials



- High dielectric strength and low mutual capacitance
- Good resistance to hot and cold water as well as to water-soluble cleaning agents (tensides, soaps,...)
- UV resistant and weather proof
- Flexible down to -40 °C

Approvals (Norm references)



Design

- Fine strands of bare copper wires
- Core insulation: TPE, halogen-free
- Cores twisted in layers in short lay lengths
- Halogen-free plastic foil wrapping
- Screen made of tinned copper wire braid
- Robust outer sheath made of special halogen-free TPE, black (RAL 9005)

Technical data

- Core identification code**
Black with white numbers acc. to VDE 0293
- Based on**
VDE 0250/0281
- Specific insulation resistance**
> 20 GOhm x cm
- Conductor stranding**
Fine wire in accordance to VDE 0295 Class 5 / IEC 60228 Class 5
- Minimum bending radius**
Occasional flexing: 20 x cable diameter
Fixed installation: 6 x cable diameter
- Rated voltage**
U₀/U: 300/500 V
- Test voltage**
Core/core: 4000 V
Core/screen: 2000 V
- Protective conductor**
G = with protective conductor GN/YE
X = without protective conductor
- Range of temperature**
Occasional flexing: -40°C up to +80°C
Fixed installation: -50°C up to +80°C

Part number	Number of cores and mm² per conductor	Outer diameter in mm approx.	Copper index kg/km	Weight kg/km approx.
ÖLFLEX® ROBUST 215 C				
0022700	2 X 0.5	5.9	36.0	42
0022701	3 G 0.5	6.2	43.0	52
0022702	3 X 0.5	6.2	43.0	52
0022703	4 G 0.5	6.6	49.0	59
0022704	4 X 0.5	6.6	49.0	59
0022705	5 G 0.5	7.1	57.0	68
0022706	5 X 0.5	7.1	57.0	68
0022708	7 G 0.5	7.7	69.0	85
0022709	7 X 0.5	7.7	69.0	85
0022711	12 G 0.5	10.1	104.0	136
0022712	18 G 0.5	11.8	141.0	189
0022713	25 G 0.5	13.7	211.0	265
0022717	2 X 0.75	6.3	43.0	50
0022718	3 G 0.75	6.6	52.0	60
0022719	3 X 0.75	6.6	52.0	60
0022720	4 G 0.75	7.1	61.0	72
0022721	4 X 0.75	7.1	61.0	72
0022722	5 G 0.75	7.9	72.0	88
0022723	5 X 0.75	7.9	72.0	88
0022724	7 G 0.75	8.5	89.0	110
0022725	7 X 0.75	8.5	89.0	110
0022727	12 G 0.75	11.1	138.0	177
0022728	18 G 0.75	13.0	211.0	247
0022729	25 G 0.75	15.1	280.0	347
0022730	34 G 0.75	17.5	380.0	460
0022733	2 X 1	6.6	51.0	60
0022734	3 G 1	6.9	62.0	70
0022735	3 X 1	6.9	62.0	70
0022736	4 G 1	7.4	74.0	85

Part number	Number of cores and mm² per conductor	Outer diameter in mm approx.	Copper index kg/km	Weight kg/km approx.
0022737	4 X 1	7.4	74.0	85
0022738	5 G 1	8.3	88.0	103
0022739	5 X 1	8.3	88.0	103
0022740	7 G 1	8.9	112.0	131
0022742	12 G 1	11.7	185.0	213
0022743	18 G 1	14.1	268.0	321
0022744	25 G 1	16.2	354.0	425
0022748	2 X 1.5	7.2	65.0	71
0022749	3 G 1.5	7.6	82.0	90
0022750	3 X 1.5	7.6	82.0	90
0022751	4 G 1.5	8.4	100.0	114
0022752	4 X 1.5	8.4	100.0	114
0022753	5 G 1.5	9.1	119.0	136
0022754	5 X 1.5	9.1	119.0	136
0022756	7 G 1.5	10.0	154.0	177
0022757	7 X 1.5	10.0	154.0	177
0022760	12 G 1.5	13.4	268.0	290
0022761	18 G 1.5	15.8	373.0	435
0022762	25 G 1.5	18.2	530.0	579
0022763	34 G 1.5	21.2	683.0	797
0022767	3 G 2.5	9.1	118.0	134
0022768	4 G 2.5	10.0	147.0	169
0022769	5 G 2.5	11.1	176.0	207
0022770	7 G 2.5	12.0	253.0	270
0022774	4 G 4	11.9	190.0	258
0022776	4 G 6	14.5	290.0	392
0022777	4 G 10	17.5	458.0	602
0022778	4 G 16	20.2	736.6	928
0022771	4 G 25	25.1	1,126.7	1,411
0022780	4 G 35	28.0	1,540.0	1,883

Copper price basis: EUR 150 / 100 kg
 Please find our standard lengths at: www.lappkabel.de/en/cable-standardlengths
 Packaging size: Coil ≤ 30 kg and ≤ 250 m, otherwise drum
 Please specify the desired packaging size (e.g. 1 x 500 m drum or 5 x 100 m coils)
 Single lengths for sizes: ≥ 4G16 max. 600m; ≥ 4G25 max. 300m; ≥ 4G50 max. 250m

Comparable products

- ÖLFLEX® FD ROBUST C
- ÖLFLEX® CLASSIC 135 CH BK 0,6/1kV

Accessories

- 3M Scotch 1183 screening tape
- SKINTOP® MS-SC-M see page 114
- SKINTOP® MS-SC-M BRUSH see page 115

Harsh use conditions

Increased mechanical and chemical resistance

ÖLFLEX® CLASSIC 400 P

PVC insulated, numbered, PUR sheath



Info

- High mechanical strength
- Slim and light, without inner sheath

Benefits

- Protected against water and dirt
- Space saving installation due to small cable diameters

Application range

- Production plants
- Measurement, control and electrical applications
- Outdoor use only in accordance with the indicated temperature range
- Especially in wet area of machine tools and transfer lines under normal mechanical stress.

Product features

- Increased oil resistance
- Abrasion and cut resistant
- Low adhesive surface

Approvals (Norm references)



Design

- Fine strands of bare copper wires
- Core insulation: Special-PVC
- Special polyurethane sheath (PUR)
- Silver grey (RAL 7001)
- DESINA® conformant, black (RAL 9005)

Technical data

- Core identification code**
Black with white numbers acc. to VDE 0293
- Based on**
Based on VDE 0281 und 0282
- Specific insulation resistance**
> 20 GOhm x cm
- Conductor stranding**
Fine wire in accordance to VDE 0295 Class 5 / IEC 60228 Class 5
- Minimum bending radius**
Occasional flexing: 12.5 x cable diameter
Fixed installation: 4 x cable diameter
- Rated voltage**
U₀/U: 300/500 V
- Test voltage**
4000 V
- Protective conductor**
G = with protective conductor GN/YE
X = without protective conductor
- Range of temperature**
Occasional flexing: -5°C up to +70°C
Fixed installation: -40°C up to +80°C

Part number	Number of cores and mm² per conductor	Outer diameter in mm approx.	Copper index kg/km	Weight kg/km approx.
ÖLFLEX® CLASSIC 400 P, U0/U: 300/500 V, grey				
1312802	2 X 0.5	4.8	10.0	32
1312003	3 G 0.5	5.1	15.0	39
1312803	3 X 0.5	5.1	15.0	39
1312004	4 G 0.5	5.7	19.2	50
1312804	4 X 0.5	5.7	19.2	50
1312005	5 G 0.5	6.2	24.0	59
1312805	5 X 0.5	6.2	24.0	59
1312007	7 G 0.5	6.7	34.0	76
1312807	7 X 0.5	6.7	34.0	76
1312010	10 G 0.5	8.6	48.0	109
1312012	12 G 0.5	8.9	57.6	125
1312018	18 G 0.5	10.5	87.0	180
1312025	25 G 0.5	12.4	120.0	250
1312034	34 G 0.5	14.3	164.0	333
1312041	41 G 0.5	15.7	197.0	400
1312852	2 X 0.75	5.4	14.4	41
1312103	3 G 0.75	5.7	21.6	51
1312853	3 X 0.75	5.7	21.6	51
1312104	4 G 0.75	6.2	28.8	62
1312854	4 X 0.75	6.2	28.8	62
1312105	5 G 0.75	6.7	36.0	74
1312855	5 X 0.75	6.7	36.0	74
1312107	7 G 0.75	7.3	50.0	97
1312857	7 X 0.75	7.3	50.0	97
1312110	10 G 0.75	9.6	72.0	142
1312112	12 G 0.75	9.9	86.4	163
1312118	18 G 0.75	11.7	129.6	234
1312125	25 G 0.75	13.8	180.0	324
1312134	34 G 0.75	15.9	244.8	431
1312141	41 G 0.75	17.4	295.2	529
1312902	2 X 1	5.7	19.2	48
1312203	3 G 1	6.0	28.8	61
1312903	3 X 1	6.0	28.8	61
1312204	4 G 1	6.5	38.4	74
1312904	4 X 1	6.5	38.4	74
1312205	5 G 1	7.1	48.0	89
1312905	5 X 1	7.1	48.0	89
1312207	7 G 1	8.0	67.0	120
1312210	10 G 1	10.2	96.0	171
1312212	12 G 1	10.5	115.0	197

Part number	Number of cores and mm² per conductor	Outer diameter in mm approx.	Copper index kg/km	Weight kg/km approx.
1312218	18 G 1	12.7	173.0	289
1312225	25 G 1	14.7	240.0	393
1312234	34 G 1	17.1	326.4	532
1312241	41 G 1	18.8	393.6	638
1312952	2 X 1.5	6.3	29.0	63
1312303	3 G 1.5	6.7	43.0	79
1312953	3 X 1.5	6.7	43.0	79
1312304	4 G 1.5	7.2	58.0	98
1312954	4 X 1.5	7.2	58.0	98
1312305	5 G 1.5	8.1	72.0	121
1312955	5 X 1.5	8.1	72.0	121
1312307	7 G 1.5	8.9	101.0	159
1312957	7 X 1.5	8.9	101.0	159
1312312	12 G 1.5	12.0	173.0	268
1312318	18 G 1.5	13.4	259.5	392
1312325	25 G 1.5	16.9	360.0	541
1312334	34 G 1.5	19.4	489.6	722
1312341	41 G 1.5	21.3	590.4	867
1312403	3 G 2.5	8.1	72.0	132
1312404	4 G 2.5	8.9	96.0	163
1312405	5 G 2.5	10.0	120.0	200
1312407	7 G 2.5	11.1	168.0	267
1312412	12 G 2.5	14.8	288.0	445
1312504	4 G 4	10.8	154.0	237
1312505	5 G 4	12.1	192.0	291
1312507	7 G 4	13.4	269.0	391
1312604	4 G 6	13.0	230.4	350
1312605	5 G 6	14.5	288.0	430
1312607	7 G 6	16.0	403.0	580
1312614	4 G 10	16.2	384.0	567
1312615	5 G 10	18.1	480.0	695
1312617	7 G 10	20.0	672.0	937
1312624	4 G 16	18.8	614.4	1,064
ÖLFLEX® CLASSIC 400 P DESINA: U0/U: 300/500 V, black				
1312970	4 G 1.5	7.2	58.0	98
1312981	7 G 1.5	8.8	101.0	159
1312983	11 G 1.5	11.6	158.0	228
1312973	4 G 2.5	8.9	96.0	163
1312975	4 G 6	13.0	230.4	350
1312976	4 G 10	16.2	384.0	567
1312978	4 G 25	23.5	940.0	1,582

Copper price basis: EUR 150 / 100 kg
 Please find our standard lengths at: www.lappkabel.de/en/cable-standardlengths
 Packaging size: Coil ≤ 30 kg and ≤ 250 m, otherwise drum
 Please specify the desired packaging size (e.g. 1 x 500 m drum or 5 x 100 m coils)
 DESINA® is a registered trademark of the Association of German Machine Tool Manufacturers

Comparable products

- ÖLFLEX® 440 P see page 45
- ÖLFLEX® 491 P see page 47

Accessories

- SKINTOP® cable glands polyamide metric see page 107
- FLEXIMARK® cable and component marking

ÖLFLEX® 440 P

TPE-insulated, numbered, PUR sheath, approved

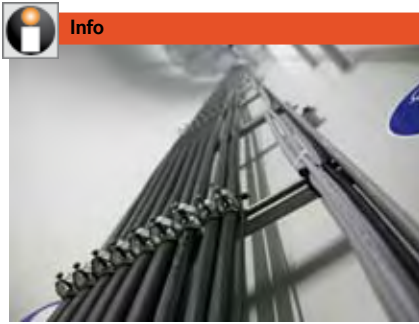

Source: PowerWind GmbH

Benefits

- Protected against water and dirt
- Fire: low corrosive smoke emission
- Cold flexible
- Wear-resistant

Application range

- Construction machinery
- Machine tools
- Especially in wet area of machine tools and transfer lines under normal mechanical stress.
- Production plants
- For indoor- and outdoor use

Product features

- Oil resistant and adhesion-free
- Abrasion and cut resistant
- Hydrolysis resistant
- Halogen-free
- Flame retardant (IEC 60332-1-2)

Approvals (Norm references)



Design

- Fine strands of tinned copper wires
- Core insulation: TPE
- Special polyurethane sheath (PUR)
- Silver grey (RAL 7001)

Technical data

- Core identification code**
Black with white numbers acc. to VDE 0293
- Specific insulation resistance**
> 20 GOhm x cm
- Conductor stranding**
Fine wire according to VDE 0295 Class 5/ IEC 60228 Class 5
- Minimum bending radius**
Occasional flexing: 15 x cable diameter
Static:
4 x cable diameter
- Rated voltage**
U0/U:
300/500 V
- Test voltage**
3000 V
- Protective conductor**
G = with protective conductor GN/YE
X = without protective conductor
- Range of temperature**
Flexing: -40°C up to +90°C
Fixed installation: -50°C up to +90°C
- VDE tested**
VDE Reg. No. 6582
4 - 6mm²: based on VDE 0281/0282

Part number	Number of cores and mm² per conductor	Outer diameter in mm approx.	Copper index kg/km	Weight kg/km approx.
ÖLFLEX® 440 P				
0012800	2 X 0.5	5.9	10.0	39
0012801	3 G 0.5	6.2	14.0	46
0012802	4 G 0.5	6.9	19.0	56
0012803	5 G 0.5	7.4	24.0	65
0012804	7 G 0.5	9.1	34.0	92
0012805	12 G 0.5	11.3	58.0	149
0012806	18 G 0.5	13.2	86.0	207
0012807	25 G 0.5	15.0	120.0	274
0012813	2 X 0.75	6.4	14.0	48
0012814	3 G 0.75	6.8	22.0	58
0012815	4 G 0.75	7.4	29.0	67
0012816	5 G 0.75	8.6	36.0	88
0012817	7 G 0.75	10.0	50.0	119
0012818	12 G 0.75	12.4	86.0	193
0012819	18 G 0.75	14.4	130.0	269
0012820	25 G 0.75	17.2	180.0	378
0012825	2 X 1	6.8	19.0	57
0012826	3 G 1	7.2	29.0	69
0012827	4 G 1	8.2	38.0	90
0012828	5 G 1	9.0	48.0	107

Copper price basis: EUR 150 / 100 kg
 Please find our standard lengths at: www.lappkabel.de/en/cable-standardlengths
 Packaging size: Coil ≤ 30 kg and ≤ 250 m, otherwise drum
 Please specify the desired packaging size (e.g. 1 x 500 m drum or 5 x 100 m coils)

Comparable products

- ÖLFLEX® ROBUST 210 see page 38
- ÖLFLEX® CLASSIC 400 P see page 44
- ÖLFLEX® 491 P see page 47

Accessories

- SKINTOP® ST-M see page 107
- Conductor end sleeves

Part number	Number of cores and mm² per conductor	Outer diameter in mm approx.	Copper index kg/km	Weight kg/km approx.
0012829	7 G 1	11.1	67.0	151
0012830	12 G 1	13.2	115.0	233
0012831	18 G 1	15.4	173.0	328
0012832	25 G 1	19.0	240.0	479
0012833	34 G 1	21.8	326.0	616
0012834	41 G 1	23.4	394.0	727
0012837	2 X 1.5	7.4	29.0	73
0012838	3 G 1.5	8.3	43.0	96
0012839	4 G 1.5	9.0	58.0	118
0012840	5 G 1.5	9.8	72.0	140
0012841	7 G 1.5	12.2	101.0	197
0012842	12 G 1.5	14.5	173.0	309
0012843	18 G 1.5	17.6	259.0	458
0012844	25 G 1.5	20.7	360.0	635
0012846	41 G 1.5	26.3	590.0	1,003
0012850	3 G 2.5	9.7	72.0	142
0012851	4 G 2.5	11.0	96.0	184
0012852	5 G 2.5	12.1	120.0	220
0012853	7 G 2.5	14.2	168.0	294
0012854	12 G 2.5	17.8	288.0	489

Harsh use conditions

Increased mechanical and chemical resistance

ÖLFLEX® 440 CP

TPE-insulated, numbered, shielded, PUR sheath, approved



Info

- All-weather control cable
- High mechanical strength
- MUD res. acc. IEC61892-4 Annex D

Benefits

- Protected against water and dirt
- Fire: low corrosive smoke emission
- Cold flexible
- Wear-resistant
- EMC compliant

- Abrasion and cut resistant
- Hydrolysis resistant
- Halogen-free
- Flame retardant (IEC 60332-1-2)

Approvals (Norm references)



Application range

- Construction machinery
- Machine tools
- Especially in wet area of machine tools and transfer lines under normal mechanical stress.
- Production plants
- For indoor- and outdoor use

Design

- Fine strands of tinned copper wires
- Core insulation: TPE
- Inner sheath: TPE
- Screen made of tinned copper wire braid
- Special polyurethane sheath (PUR)
- Silver grey (RAL 7001)

Product features

- Oil resistant and adhesion-free

Technical data

- Core identification code**
Black with white numbers acc. to VDE 0293
- Specific insulation resistance**
> 20 GOhm x cm
- Conductor stranding**
Fine wire in accordance with VDE 0295, Class 5
- Minimum bending radius**
Occasional flexing: 15 x cable diameter
- Rated voltage**
300/500 V
- Test voltage**
3000 V
- Protective conductor**
G = with protective conductor GN/YE
X = without protective conductor
- Range of temperature**
Flexing: -40°C up to +90°C
Fixed installation: -50°C up to +90°C
- VDE tested**
VDE Reg. No. 6582
4 - 6mm²: based on VDE 0281/0282

Part number	Number of cores and mm ² per conductor	Outer diameter in mm approx.	Copper index kg/km	Weight kg/km approx.
ÖLFLEX® 440 CP				
0012901	3 G 0.5	8.3	44.0	100
0012902	4 G 0.5	8.8	52.0	120
0012903	5 G 0.5	9.7	61.0	139
0012904	7 G 0.5	11.2	75.0	175
0012906	12 G 0.5	13.7	131.0	276
0012907	18 G 0.5	15.7	168.0	376
0012908	25 G 0.5	18.5	212.0	485
0012911	2 X 0.75	8.4	45.0	104
0012912	3 G 0.75	8.7	52.0	119
0012913	4 G 0.75	9.5	67.0	142
0012914	5 G 0.75	10.2	75.0	165
0012915	7 G 0.75	11.9	96.0	210
0012917	12 G 0.75	14.5	160.0	331
0012919	25 G 0.75	20.3	283.0	596
0012925	2 X 1	8.7	49.0	117
0012926	3 G 1	9.3	60.0	132
0012927	4 G 1	9.9	78.0	163
0012928	5 G 1	10.8	88.0	187
0012929	7 G 1	12.8	115.0	255
0012931	12 G 1	15.4	201.0	419
0012932	18 G 1	17.7	267.0	546
0012933	25 G 1	21.5	351.0	738
0012934	34 G 1	23.8	498.0	972
0012940	2 X 1.5	9.5	68.0	159
0012941	3 G 1.5	9.9	83.0	180
0012942	4 G 1.5	10.8	102.0	217
0012943	5 G 1.5	11.6	119.0	265
0012944	7 G 1.5	14.2	186.0	331
0012945	12 G 1.5	16.8	264.0	554
0012946	18 G 1.5	20.0	379.0	782
0012947	25 G 1.5	23.5	534.0	1,059
0012949	41 G 1.5	28.9	803.0	1,579
0012950	3 G 2.5	11.4	121.0	264
0012951	4 G 2.5	12.6	145.0	307
0012952	5 G 2.5	14.0	205.0	413
0012953	7 G 2.5	16.4	259.0	533
0012954	12 G 2.5	21.0	407.0	795

Copper price basis: EUR 150 / 100 kg
 Please find our standard lengths at: www.lappkabel.de/en/cable-standardlengths
 Packaging size: Coil ≤ 30 kg and ≤ 250 m, otherwise drum
 Please specify the desired packaging size (e.g. 1 x 500 m drum or 5 x 100 m coils)

Comparable products

- ÖLFLEX® CLASSIC 400 CP
- ÖLFLEX® FD 855 CP

Accessories

- SKINTOP® MS-SC-M see page 114
- Conductor end sleeves

ÖLFLEX® 491 P

PVC insulated, numbered, PUR sheath, approved



Info

- For export orientated users
- High mechanical strength

Benefits

- Protected against water and dirt
- Wear-resistant

Application range

- Devices
- Appliances
- Especially in wet area of machine tools and transfer lines under normal mechanical stress.
- Outdoor use only in accordance with the indicated temperature range

Product features

- Increased oil resistance
- Abrasion and cut resistant



- Low adhesive surface

- Flame retardant in accordance with UL/CSA FT1 and IEC 60332.1-2

Approvals (Norm references)



- USA: Acc. NFPA79 Ed 08 in industrial machinery as part of a listed assembly only.

Design

- Fine strands of bare copper wires
- PVC insulation LAPP P8/1
- Special polyurethane sheath (PUR)
- DESINA® conformant, black (RAL 9005)
- Silver grey (RAL 7001)

Technical data

- Core identification code**
Black with white numbers acc. to VDE 0293
- Approvals**
In accordance with UL-AWM Style 20234 cUL AWM II A/B FT1
- Specific insulation resistance**
> 20 GOhm x cm
- Conductor stranding**
Fine wire according to VDE 0295 Class 5/ IEC 60228 Class 5
- Minimum bending radius**
For flexible applications: 15 x D
For fixed installation: 4 X D
- Rated voltage**
In accordance with HAR U0: 300/500 V
UL + CSA U: 600 V
- Test voltage**
Test voltage: 4000 V
- Protective conductor**
G = with protective conductor GN/YE
X = without protective conductor
- Range of temperature**
For flexible applications: -5°C up to 80°C
For fixed installation: -40°C to 80°C

Part number	Number of cores and mm ² per conductor	AWG	Outer diameter in mm approx.	Copper index kg/km	Weight kg/km approx.
ÖLFLEX® 491 P BK (black)					
0013009	3 G 1	18	7.7	27.0	73
0013017	3 G 1.5	16	8.3	44.0	100
0013018	4 G 1.5	16	9.0	58.0	123
0013019	5 G 1.5	16	9.8	72.0	150
0013020	7 G 1.5	16	10.7	101.0	197
0013021	12 G 1.5	16	13.8	173.4	344
0013023	25 G 1.5	16	20.0	360.0	682
0013024	3 G 2.5	14	9.2	72.0	152
0013025	4 G 2.5	14	9.9	96.0	200
ÖLFLEX® 491 P GY (grey)					
0013208	2 X 1	18	7.3	19.2	62
0013210	4 G 1	18	8.2	35.0	89
0013212	7 G 1	18	9.7	61.0	138
0013213	12 G 1	18	12.5	105.0	232
0013214	18 G 1	18	14.8	157.0	340
0013215	25 G 1	18	17.8	218.0	454
0013223	3 G 1.5	16	8.3	44.0	100
0013220	4 G 1.5	16	9.0	57.6	123
0013222	7 G 1.5	16	10.7	101.0	197
0013225	12 G 1.5	16	13.8	173.0	344
0013226	18 G 1.5	16	16.6	260.0	488
0013227	25 G 1.5	16	20.0	360.0	682

Copper price basis: EUR 150 / 100 kg
 Please find our standard lengths at: www.lappkabel.de/en/cable-standardlengths
 Packaging size: Coil ≤ 30 kg and ≤ 250 m, otherwise drum
 Please specify the desired packaging size (e.g. 1 x 500 m drum or 5 x 100 m coils)
 DESINA® is a registered trademark of the Association of German Machine Tool Manufacturers

Comparable products

- ÖLFLEX® CLASSIC 400 P see page 44
- ÖLFLEX® FD 891 P

Accessories

- SKINTOP® ST-M see page 107
- Cable Marking Products



Harsh use conditions

Increased mechanical and chemical resistance

ÖLFLEX® CONTROL M



Info

- According to NFPA 79 Edition 2007 "Electrical Standard for Industrial Machinery" USA
- Increased oil resistance

Benefits

- Broad application range due to multiple approvals
- CE-compliant usage in Europe due to metric adapted sizes of the AWG conductors
- Cost saving, easy installation due to renouncement of closed raceways (suitable for open wiring)

Application range

- Industrial machinery; plant engineering
- Machine tools UL MTW (Machine Tool Wiring) conforming
- Direct usage inside metal processing cabins of machine tools due to increased oil- and wet rating
- TC-ER (Tray Cable Exposed Run) approval for open wiring between cable tray and industrial machines/plants acc. to NEC 336.10(7)
- Wind Turbines: USA Wind Turbine Tray Cable (WTTCC)

Product features

- Flame retardant according to CSA FT4 UL Vertical-Tray Flame Test
- Increased oil resistant according to UL OIL RES I and UL OIL RES II
- Water resistant UL Wet Approval 75 °C

Approvals (Norm references)



Design

- Finely stranded bare copper wires metric adapted AWG sizes
- Core insulation: PVC with nylon jacket (PA skin)
- Special blended PVC outer sheath, grey (RAL 7001)

Technical data



Core identification code

Black cores with white numbers
Alternatively available:
B=blue cores, R= red cores, Y= yellow cores with printed numbers



Approvals

UL MTW and UL TC-ER
c(UL) Type TC and CIC FT4
UL/CSA AWM I/II A/B FT4
NOM (Normas Oficiales Mexicanas)



Specific insulation resistance

> 20 GOhm x cm



Conductor stranding

Finely stranded bare copper wires metric adapted AWG sizes



Minimum bending radius

5 x cable diameter



Rated voltage

UL/CSA: 600 V (TC, MTW, CIC), WTTCC 1000V
UL/CSA: 1000 V (AWM)
HAR U₀/U₁: 300/500 V



Test voltage

2000 V



Protective conductor

G = with protective conductor GN/YE
X = without protective conductor



Range of temperature

Occasional flexing: -10°C to +90°C
(AWM +105 °C)
Fixed installation: -40°C up to +90 °C
(AWM +105°C)

Part number	Number of cores and mm² per conductor	AWG	Outer diameter in mm approx.	Copper index kg/km	Weight kg/km approx.
ÖLFLEX® CONTROL M					
431803	3 G 1	18	7.6	28.8	85
431804	4 G 1	18	8.1	38.4	98
431805	5 G 1	18	8.8	48.0	115
431807	7 G 1	18	9.5	67.0	149
431812	12 G 1	18	12.1	115.0	255
431818	18 G 1	18	14.9	173.0	365
431825	25 G 1	18	16.9	240.0	479
431603	3 G 1.5	16	8.3	43.0	103
431604	4 G 1.5	16	8.9	58.0	124
431605	5 G 1.5	16	9.7	72.0	146
431607	7 G 1.5	16	10.5	101.0	189
431609	9 G 1.5	16	12.1	230.0	255
431612	12 G 1.5	16	14.3	173.0	328
431618	18 G 1.5	16	16.6	259.0	431
431625	25 G 1.5	16	18.8	360.0	592
431403	3 G 2.5	14	8.8	72.0	130
431404	4 G 2.5	14	9.6	96.0	159
431405	5 G 2.5	14	10.8	120.0	191
431407	7 G 2.5	14	11.8	168.0	252
431204	4 G 4	12	11.7	153.0	226
431205	5 G 4	12	12.8	192.0	279
431207	7 G 4	12	14.8	269.0	384
431004	4 G 6	10	15.0	231.0	394
431005	5 G 6	10	16.3	288.0	472
430804	4 G 10	8	18.4	384.0	615
430604	4 G 16	6	22.8	615.0	864

Copper price basis: EUR 150 / 100 kg
Please find our standard lengths at: www.lappkabel.de/en/cable-standardlengths
Packaging size: Coil ≤ 30 kg and ≤ 250 m, otherwise drum
Coil 100 m; 35 mm² and larger: 50 m

Comparable products

- ÖLFLEX® CONTROL TM see page 39
- ÖLFLEX® TRAY II see page 41

Accessories

- SKINTOP® MS-M see page 113
- SKINTOP® ST-M see page 107

New

ÖLFLEX® TORSION FRNC

Cold- and oil resistant cables for flexible application under torsionally load - 0,6/1 kV



Info

- Torsion resistant and very flexible
- Improved characteristics in case of fire
- Internationally approved

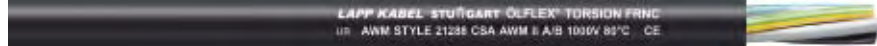

ÖLFLEX® TORSION D FRNC

Screened cold- and oil resistant cables for flexible application under torsionally load - 0,6/1 kV



Info

- Screened EMC compatible version



Benefits

- The special construction compensates reliably the permanent torsional movements inside of windmills between the nacelle and the tower
- The high flexibility and the good dismantle and stripping properties enable easy space-saving cable installation and fast processing
- Saltwater resistant for On- and Off-Shore application
- **FRNC = Flame Retardant Non Corrosive**
 - Reduction of flame propagation and density and toxicity of smoke gases in event of fire
 - Minimisation of damage to buildings and production facilities
 - Safety for maintenance staff resp. in areas with high personnel concentration
- The copper wrapping of the screened D version assures EMC and protects against electromagnetic interference

Application range

- For fixed, flexible as well as torsionally moved applications in the field of machinery building and wind power plant engineering
- Especially for the so-called loop-installation between the rotating nacelle and the stationary windmill tower to connect the generator and control units

Product features

- Torsion resistant up to +/-150° /mtr

- Good weather-, abrasion-, temperature- and UV resistance
- Good resistance against hydraulic and gear oils
- Halogen free and flame retardant
- Considering economic minimum quantities also customized designs are possible

Approvals (Norm references)



- UL AWM Style 21288 / CSA AWM II A/B
- Fire behaviour :
 - Halogen free (IEC 60754-1)
 - Corrosivity of gases (IEC 60754-2)
 - Smoke density (IEC 61034-2)
 - Flame retardant (IEC 60332-1-2)
 - No flame propagation (IEC 60332-3-24 resp. IEC 60332-3-25)
 - Complies with CSA FT4 flame test
- Oil resistant acc. to VDE 0473 part 811-2-1 and UL OIL RES I and UL OIL RES II

Design

- Super fine wired conductor of plain copper
- Core insulation of halogen free polyolefin polymer
- Cores torsion optimized twisted into layers
- Optional screening (D) of helically tinned copper wire wrapping
- Outer sheath of halogen free special compound, colour black (RAL 9005)

Technical data

- **Core identification code**
Control and connection cables:
Colour coded according to VDE 0293-308, see Appendix T9
Starting at 6 cores: Black with white numbers
Paired signal cables: DIN 47100
- **Approvals**
UL AWM Style 21288
CSA AWM II A/B
- **Specific insulation resistance**
> 20 GOhm x cm
- **Conductor stranding**
Extra fine wire in acc. to VDE 0295 Cl.6 / IEC 60228 Cl.6
- **Minimum bending radius**
Flexible use: 10 x outer diameter
Fixed installed : 6 x outer diameter
- **Rated voltage**
nach VDE: U_c/U₀ 0,6/1,0 kV
Working voltage acc. UL/CSA: 1000V
- **Test voltage**
ÖLFLEX® TORSION FRNC
C/C: 4000 V
ÖLFLEX® TORSION D FRNC
C/C: 4000 V
C/S: 2000 V
- **Protective conductor**
G = with protective conductor GN/YE
X = without protective conductor
- **Range of temperature**
Flexible use: -40°C up to +90°C (UL +80°C)
Static use: -40°C up to +90°C (UL +80°C)

Part number	Number of cores and mm² per conductor	Outer diameter in mm approx.	Copper index kg/km	Weight kg/km approx.
ÖLFLEX® TORSION FRNC				
1150199	12 G 0.75	12.4	86.4	237
1150377	14 G 0.75	13.0	100.8	291
1150201	18 G 0.75	14.6	129.6	323
1150204	25 G 0.75	17.8	180.0	480
1150208	50 G 0.75	24.2	360.0	886
1150373	12 G 1	13.2	115.2	274
1150378	16 G 1	14.8	153.6	392
1150271	3 G 1.5	9.0	43.2	131
1150272	4 G 1.5	9.7	57.6	156
1150273	5 G 1.5	10.6	72.0	183
1150275	7 G 1.5	12.6	100.8	253
1150279	12 G 1.5	15.3	172.8	386
1150374	25 G 1.5	22.8	360.0	837
1150375	32 G 1.5	24.5	460.8	994
1150311	3 G 2.5	10.4	72.0	181
1150312	4 G 2.5	11.3	96.0	242
1150313	5 G 2.5	12.4	120.0	258
1150315	7 G 2.5	15.0	168.0	372

Part number	Number of cores and mm² per conductor	Outer diameter in mm approx.	Copper index kg/km	Weight kg/km approx.
1150322	19 G 2.5	23.9	456.0	925
1150376	25 G 2.5	26.8	600.0	1,183
1150351	4 G 4	13.0	153.6	313
1150352	5 G 4	14.3	192.0	370
1150356	4 G 6	14.4	230.4	401
1150357	5 G 6	16.0	288.0	486
1150361	4 G 10	18.4	384.0	658
1150362	5 G 10	20.5	480.0	799
1150366	4 G 16	22.2	614.4	1,061
1150367	5 G 16	24.4	768.0	1,188
1150371	4 G 25	26.9	960.0	1,526
1150372	5 G 25	29.9	1,200.0	1,881
ÖLFLEX® TORSION D FRNC - screened				
1150111	4 x 2 x 0.5	11.9	71.0	205
1150115	12 x 2 x 0.5	18.3	188.0	518
1150121	4 x 2 x 0.75	12.7	90.0	232
1150125	12 x 2 x 0.75	19.8	258.0	603
1150221	18 G 0.75	15.2	180.0	402
1150228	50 G 0.75	24.9	470.0	1,079

Copper price basis: EUR 150 / 100 kg
 Please find our standard lengths at: www.lappkabel.de/en/cable-standardlengths
 Packaging size: Coil ≤ 30 kg and ≤ 250 m, otherwise drum
 Please specify the desired packaging size (e.g. 1 x 500 m drum or 5 x 100 m coils)



Power chain applications

Wide range use, approved

ÖLFLEX® FD 90 CY

Screened, PVC- insulated, PVC sheath, single core, approved



Info

- Multi-Standard: many countries, one cable
- EMC compliant

Benefits

- Multi-Standard= less part varieties= cost savings
- Easy laying
- Wide range of application opportunities

- Designed for operation under a minimum bending radius of at least 7.5 times the cable diameter

Approvals (Norm references)



- For travel distances up to 10 m.
- Usage in Power Chains: Please comply with the assembly guidelines Appendix T3
- USA: Acc. NFPA79 Ed 08 in industrial machinery as part of a listed assembly only.
- Multi standard cables with mm² and AWG/ KCMIL (MCM) sizes normally have special conductor strands, which means that one of the specified conductor cross-sections works out greater than the specified nominal value.

Application range

- In power chains or moving machine parts
- For internal wiring of electric and electronic equipment in switch cabinets
- Specially designed power circuits of servo motors driven by frequency converters as well as main spindle drives in machine tools
- This cable can also substitute multi-core shielded servo drive cables where space requirements or minimum bending radii present problems
- Test systems of the automotive industry, vehicles and stationary fuel cell systems

Design

- Extra fine strands of plain copper wires (Class 6)
- Core insulation: PVC
- Nonwoven wrapping
- Screen made of tinned copper wire braid
- Nonwoven wrapping
- PVC outer sheath, orange (RAL 2003)

Product features

- Oil resistant
- Low adhesive surface
- Flame retardant in accordance with IEC 60332-1-2 and CSA FT 1

Technical data

Core identification code
Black, other colours on request.

Approvals
UL-AWM-Style 10107 VW-1
CSA AWM IA/B IIA/B FT 1

Based on
VDE 0250, 0281

Specific insulation resistance
> 20 GOhm x cm

Conductor stranding
Extra fine wire in according to VDE 0295 Class 6 / IEC 60228 Class 6

Minimum bending radius
For flexible applications: 7.5 x outside diameter
Fixed installation: 3 x outer diameter

Rated voltage
IEC: 600/1000 V
UL & CSA: 600 V

Test voltage
4000 V

Protective conductor
X = without protective conductor

Range of temperature
Occasional flexing: -5 °C to +90 °C
Fixed installation: -40 °C up to +90 °C

Part number	Number of cores and mm ² per conductor	AWG	Outer diameter in mm approx.	Core colour	Copper index kg/km	Weight kg/km approx.
ÖLFLEX® FD 90 CY						
0026651	1 X 10	8	10.2	black	127.6	227
0026653	1 X 16	6	11.7	black	186.2	297
0026655	1 X 25	4	13.0	black	257.8	410
0026657	1 X 35	2	15.6	black	400.7	607
0026659	1 X 50	1	17.7	black	554.8	808
0026661	1 X 70	2/0	20.0	black	775.6	1,081
0026663	1 X 95	3/0	21.7	black	1,028.1	1,382
0026665	1 X 120	4/0	24.8	black	1,282.4	1,752
0026667	1 X 150	250	27.0	black	1,410.4	1,924
0026669	1 X 185	350	30.0	black	1,935.0	2,611
0026671	1 X 240	450	32.7	black	2,526.0	3,372
0026673	1 X 300	500	35.6	black	3,128.8	4,105

Copper price basis: EUR 150 / 100 kg
 Please find our standard lengths at: www.lappkabel.de/en/cable-standardlengths
 Packaging size: Coil ≤ 30 kg and ≤ 250 m, otherwise drum
 Please specify the desired packaging size (e.g. 1 x 500 m drum or 5 x 100 m coils)
 DESINA® is a registered trademark of the Association of German Machine Tool Manufacturers

Accessories

- SKINTOP® MS-SC-M see page 114
- SKINTOP® MS-SC-M BRUSH see page 115
- SILVYN® CHAIN Cable protection and guiding systems

ÖLFLEX® PETRO 125 P plus

Oil- and UV resistant / voltage rating 0,6/1 kV

ÖLFLEX® PETRO 125 BP plus

Oil- and UV resistant, bronze-armoured / voltage rating 0,6/1 kV



Info

- Mineral oil and Mud tested according to IEC 61892-4, Annex D
- Halogen-free and highly flame retardant
- Armoured against mechanical stress

Benefits

- In case of fire the formation of toxic gases and the spreading of the fire is reduced
- The bronze armouring braid of the BP version protects against mechanical stress and prevents sparking

Application range

- For on- and offshore applications as for instance marine vessels or stationary and mobile drilling rigs
- For electrical connection of pumping stations, compressors, generators or also emergency power supply respectively emergency lighting in harsh environmental conditions
- Due to the outstanding mechanical, thermal and physical properties the product also is useful in other industries

Product features

- Cable sheath material complies with the requirements for drilling fluids as per IEC 61892-4, Annex D
- Halogen-free and highly flame retardant
- Excellent moisture, UV- and mechanical abrasion resistance

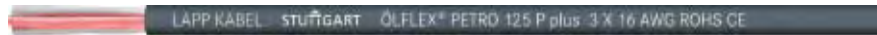

- Considering economic minimum quantities also customized designs are possible
- No stock item

Approvals (Norm references)



- Oil and Mud resistant according to NEK 606:2004 respectively IEC 61892-4, Annex D

Design

ÖLFLEX® PETRO 125 P plus

- Multi wired strands of tinned copper
- Core insulation: Based on Polyolefin
- Cores twisted in layers
- Outer sheath of TPE based compound

ÖLFLEX® PETRO 125 BP plus

- Multi wired strands of tinned copper
- Core insulation: Based on Polyolefin
- Cores twisted in layers
- Inner sheath made of TPE
- Armouring of bronze wire braiding
- Plastic foil wrapping
- Outer sheath of TPE based compound

Technical data



Core identification code

Up to 5 cores:
According to UL 1309 App. A: BK, WH, RD, GN, OG
Above 5 cores:
black with numbers



Fire test

Flame retardant in accordance with IEC 60 332-1-2 or IEC 60 332-3-22 Cat. A



Conductor stranding

Multi wired AWG sizes according ASTM



Rated voltage

U₀/U 600/1000 V



Test voltage

4000 V



Range of temperature

Static use: -40°C up to +125°C

Part number	Number of cores and AWG per conductor	Conductor cross section in mm ²	Outer diameter in mm approx.	Copper index kg/km	Weight kg/km approx.
ÖLFLEX® PETRO 125 P plus - multi core cables					
0023101	3 X 16 AWG	1.5	9.6	37.6	134
0023102	4 X 16 AWG	1.5	10.4	50.2	161
0023103	5 X 16 AWG	1.5	11.2	62.7	193
0023111	3 X 14 AWG	2.5	10.2	54.2	162
0023112	4 X 14 AWG	2.5	11.1	72.2	197
0023113	5 X 14 AWG	2.5	13.3	90.3	271
0023121	3 X 12 AWG	4	11.3	88.5	216
0023122	4 X 12 AWG	4	12.3	118.0	267
0023123	5 X 12 AWG	4	13.4	147.5	323
0023131	3 X 10 AWG	6	13.1	154.6	321
0023132	4 X 10 AWG	6	14.3	206.1	401
0023135	4 X 8 AWG	10	17.2	282.4	565
0023140	4 X 6 AWG	16	19.7	465.6	820
0023145	4 X 4 AWG	25	25.5	801.4	1,397
0023150	4 X 2 AWG	35	29.6	1,144.8	1,933
ÖLFLEX® PETRO 125 BP plus - bronze armoured cables					
0023201	3 X 16 AWG	1.5	13.8	37.6	308
0023202	4 X 16 AWG	1.5	14.6	50.2	349
0023203	5 X 16 AWG	1.5	15.5	62.7	394
0023211	3 X 14 AWG	2.5	14.5	54.2	347
0023212	4 X 14 AWG	2.5	15.3	72.2	396
0023213	5 X 14 AWG	2.5	16.3	90.3	451
0023221	3 X 12 AWG	4	15.6	88.5	418
0023222	4 X 12 AWG	4	16.6	118.0	485
0023223	5 X 12 AWG	4	17.7	37.6	569
0023231	3 X 10 AWG	6	17.4	154.6	552
0023232	4 X 10 AWG	6	18.6	206.1	651

Copper price basis: EUR 150 / 100 kg
Please find our standard lengths at: www.lappkabel.de/en/cable-standardlengths
Packaging size: Coil ≤ 30 kg and ≤ 250 m, otherwise drum
Please specify the desired packaging size (e.g. 1 x 500 m drum or 5 x 100 m coils)



Expanded ambient temperatures

Silicone cables (-50°C up to +180°C)

ÖLFLEX® HEAT 180 SiHF

Silicone cables with extended temperature range



Info

- The classic for multisided use
- For thermal class H applications

Benefits

- Good flexibility ease the installation where space is limited
- Possess still insulating properties after combustion due to remaining SiO₂ ash on the conductor

Application range

- Areas with high ambient temperatures where insulating and sheath materials of conventional cables will embrittle after a short while
- Typical fields of application
 - Steel-, cement-, ceramic and iron works
 - Bakery equipment and industrial furnaces
 - Electric motor industry
 - Sauna/solarium construction
 - Thermal and heating elements
 - Lighting technology
 - Ventilator engineering
 - Air conditioning technology
 - Galvanization technology
 - Polymer processing
 - Generator and transformer building
 - Wind turbine engineering

Product features

- Halogen-free and flame retardant (IEC 60332-1-2)
- Reduced smoke density
- Resistant against a multitude of oils, alcohols, vegetable and animal fats and chemical media

Approvals (Norm references)



Design

- Fine strands of tinned copper wires
- Core insulation: Based on Silicone
- Cores twisted in layers
- Silicone based outer sheath, colour redbrown

Technical data

- Core identification code**
Colour coded according to VDE 0293-308, see Appendix T9
Starting at 6 cores: Black with white numbers
- Based on**
VDE regulation VDE 0250
- Specific insulation resistance**
>200 GOhm x cm
- Conductor stranding**
Fine wire according to VDE 0295 Class 5/ IEC 60228 Class 5
- Minimum bending radius**
For flexible applications:
15 x cable diameter
Fixed installation:
4 x cable diameter
- Rated voltage**
U_i/U 300/500 V
- Test voltage**
2000 V
- Protective conductor**
G = with protective conductor GN/YE
X = without protective conductor
- Range of temperature**
-50 °C up to +180 °C
(adequate ventilation provided)

Part number	Number of cores and mm ² per conductor	Outer diameter mm	Copper index kg/km	Weight kg/km approx.
ÖLFLEX® HEAT 180 SiHF				
0046001	2 X 0.75	6.4	14.4	53.4
0046002	3 G 0.75	6.8	21.6	63.7
00460033	4 G 0.75	7.6	28.8	83.6
00460043	5 G 0.75	8.5	36.0	101.2
0046005	6 G 0.75	9.2	43.2	116.8
0046006	7 G 0.75	9.2	50.4	124.9
0046007	2 X 1	6.6	19.2	59.9
0046008	3 G 1	7.0	29.0	78.2
00460093	4 G 1	7.9	38.4	94.5
00460103	5 G 1	8.8	48.0	116.0
0046012	7 G 1	9.5	67.0	144.2
0046013	2 X 1.5	7.6	29.0	81.7
0046014	3 G 1.5	8.0	43.0	98.3
00460153	4 G 1.5	8.8	58.0	122.4
00460163	5 G 1.5	9.6	72.0	148.0
0046018	7 G 1.5	10.4	101.0	187.3
0046039	12 G 1.5	14.0	173.0	315.0
0046040	16 G 1.5	16.2	230.4	446.0
0046041	20 G 1.5	17.5	288.0	566.0

Part number	Number of cores and mm ² per conductor	Outer diameter mm	Copper index kg/km	Weight kg/km approx.
0046042	24 G 1.5	19.8	345.6	722.0
0046019	2 X 2.5	8.8	48.0	135.0
0046020	3 G 2.5	9.7	72.0	152.3
00460213	4 G 2.5	10.6	96.0	188.7
00460223	5 G 2.5	11.6	120.0	229.3
0046024	7 G 2.5	12.6	168.0	293.4
0046025	2 X 4	10.8	76.8	181.4
0046026	3 G 4	11.5	115.0	224.0
00460273	4 G 4	12.6	154.0	294.8
00460283	5 G 4	14.0	192.0	359.4
0046030	7 G 4	15.6	269.0	480.0
0046031	2 X 6	12.4	116.0	274.2
0046032	3 G 6	13.2	173.0	338.4
00460333	4 G 6	14.7	230.0	442.1
00460343	5 G 6	16.6	288.0	535.1
0046036	7 G 6	18.6	403.0	685.5
00460373	4 G 10	19.4	384.0	707.1
00460453	5 G 10	21.6	480.0	866.6
00460383	4 G 16	22.0	614.0	987.5

Copper price basis: EUR 150 / 100 kg

Please find our standard lengths at: www.lappkabel.de/en/cable-standardlengths

Packaging size: Coil ≤ 30 kg and ≤ 250 m, otherwise drum

Please specify the desired packaging size (e.g. 1 x 500 m drum or 5 x 100 m coils)

Comparable products

- ÖLFLEX® HEAT 180 H05SS-F EWKF see page 53
- ÖLFLEX® HEAT 180 EWKF

ÖLFLEX® HEAT 180 H05SS-F EWKF

Harmonized silicone cables with increased mechanical performance



Info

- International use combined with proved EWKF quality
- For thermal class H applications

Benefits

- European wide use due to HARmonization
- Notch and tear resistant silicone compounds reduce mechanical damage
- In harsh applications longer durability than conventional H05SS-F standardized cables
- Good flexibility ease the installation where space is limited
- Possess still insulating properties after combustion due to remaining SiO2 ash on the conductor

Application range

- Areas with high ambient temperatures and additionally high mechanical stress
- Typical fields of application
 - Steel-, cement-, ceramic and iron works
 - Bakery equipment and industrial furnaces
 - Electric motor industry
 - Sauna/solarium construction
 - Thermal and heating elements
 - Lighting technology
 - Ventilator engineering
 - Air conditioning technology
 - Galvanization technology
 - Polymer processing
 - Generator and transformer building
 - Wind turbine engineering

Product features

- Halogen-free and flame retardant (IEC 60332-1-2)
- Reduced smoke density
- Good hydrolysis and UV resistance
- Resistant against a multitude of oils, alcohols, vegetable and animal fats and chemical media
- EWKF Formula: Increased initial tear propagation and notch resistance

Approvals (Norm references)



- HD 22.15 S1 (H05SS-F)

Design

- Fine strands of tinned copper wires
- Core insulation: Based on EWKF silicone
- Cores twisted together
- Notch resistant silicone based EWKF outer sheath, colour black (RAL 9005)

Technical data

- Core identification code**
Colour coded according to VDE 0293-308, see Appendix T9
- Approvals**
HD 22.15 S1 (H05SS-F)
- Specific insulation resistance**
>200 GOhm x cm
- Conductor stranding**
Fine wire according to VDE 0295 Class 5/ IEC 60228 Class 5
- Minimum bending radius**
For flexible applications:
15 x cable diameter
- Rated voltage**
U₀/U 300/500 V
- Test voltage**
2000 V
- Protective conductor**
G = with protective conductor GN/YE
X = without protective conductor
- Range of temperature**
-50 °C up to +180 °C
(adequate ventilation provided)

Part number	Number of cores and mm² per conductor	Outer diameter mm	Copper index kg/km	Weight kg/km approx.
ÖLFLEX® HEAT 180 H05SS-F EWKF				
0046900	2 X 0.75	6.4	14.4	54.0
0046901	3 G 0.75	7.0	21.6	67.0
00469023	4 G 0.75	7.6	28.8	87.0
00469033	5 G 0.75	8.5	36.0	105.0
0046904	2 X 1	6.8	19.2	63.0
0046905	3 G 1	7.2	28.8	81.0
00469063	4 G 1	7.9	38.4	98.0
00469073	5 G 1	8.8	48.0	121.0
0046908	2 X 1.5	8.4	28.8	84.0
0046909	3 G 1.5	8.9	43.2	103.0
00469103	4 G 1.5	9.9	57.6	128.0
00469113	5 G 1.5	10.9	72.0	154.0
0046912	2 X 2.5	9.8	48.0	141.0
0046913	3 G 2.5	10.4	72.0	158.0
00469143	4 G 2.5	11.6	96.0	195.0
00469153	5 G 2.5	12.9	120.0	241.0
0046916	3 G 4	12.3	115.2	239.0
00469173	4 G 4	13.7	153.6	312.0
0046919	3 G 6	14.0	172.8	345.0
00469203	4 G 6	15.6	230.4	451.0

Copper price basis: EUR 150 / 100 kg
 Please find our standard lengths at: www.lappkabel.de/en/cable-standardlengths
 Packaging size: Coil ≤ 30 kg and ≤ 250 m, otherwise drum
 Please specify the desired packaging size (e.g. 1 x 500 m drum or 5 x 100 m coils)

Comparable products

- ÖLFLEX® HEAT 180 EWKF
- ÖLFLEX® HEAT 180 EWKF C see page 55



Expanded ambient temperatures

Silicone cables (-50°C up to +180°C)

ÖLFLEX® HEAT 180 UL/CSA

UL/CSA approved silicone cables (AWM)



Info

- For the use in the USA and in Canada
- UL AWM Style 4476 150°C/600V

New

ÖLFLEX® HEAT 180 C UL/CSA

Screened UL/CSA approved silicone cables (AWM)



Info

- Screened EMC compatible version

Benefits

- UL and CSA approval for export-oriented appliance and apparatus builders
- Thicker cable design meets the requirements of the FT-1 Vertical Flame Test and is thus also approved for installation in accordance with UL outside of apparatus and appliances
- Good flexibility ease the installation where space is limited
- The copper braid of the C- version protects against electromagnetic interference

Application range

- Areas with high ambient temperatures where insulating and sheath materials of conventional cables will embrittle after a short while
- Typical fields of application
 - Steel-, cement-, ceramic and iron works
 - Bakery equipment and industrial furnaces
 - Electric motor industry
 - Sauna/solarium construction
 - Thermal and heating elements
 - Lighting technology
 - Ventilator engineering
 - Air conditioning technology
 - Galvanization technology
 - Polymer processing
 - Generator and transformer building
 - Wind turbine engineering

Product features

- Metric flexible conductor design
- Halogen-free and flame retardant (IEC 60332-1-2)
- Reduced smoke density
- Good hydrolysis and UV resistance
- Resistant against a multitude of oils, alcohols, vegetable and animal fats and chemical media

Approvals (Norm references)



- UL AWM 4476 and CSA AWM II A/B
- Also available on request as special product with AWM rating 200°C/600 V
- Multi-conductor Type AWM cables (Appliance Wiring Material) shall be permitted for industrial machinery (US) when part of a listed assembly suitable for the intended use only. NFPA 79 Edition 2007 §12.2.7.3

Design

- Fine strands of tinned copper wires
- Silicone based core insulation
- Cores twisted together
- Optional copper screen braid (C-version)
- Silicone based outer sheath, colour black

Technical data



Core identification code

Colour coded according to VDE 0293-308, see Appendix T9
Starting at 6 cores: Black with white numbers



Approvals

UL AWM Style 4476 (Construction B)
CSA AWM II A/B



Specific insulation resistance

>200 GOhm x cm



Conductor stranding

Fine wire in accordance to VDE 0295
Class 5 / IEC 60228 Class 5



Minimum bending radius

ÖLFLEX® HEAT 180 UL/CSA
Occasional flexing: 15 x cable diameter
Fixed installation: 4 x cable diameter
ÖLFLEX® HEAT 180 C UL/CSA
Occasional flexing: 20 x cable diameter
Fixed installation: 6 x cable diameter



Rated voltage

VDE U0/U: 300/500 V
Operating voltage UL/CSA: 600 V



Test voltage

2000 V



Protective conductor

G = with protective conductor GN/YE
X = without protective conductor



Range of temperature

VDE: -50°C up to +180°C
According to UL/CSA: up to +150°C
(adequate ventilation provided)

Part number	Number of cores and mm ² per conductor	AWG	Outer diameter mm	Copper index kg/km	Weight kg/km approx.
ÖLFLEX® HEAT 180 UL/CSA					
0046600	2 X 0.5	20	7.6	9.8	72.0
0046601	3 G 0.5	20	8.0	14.7	83.0
0046602	4 G 0.5	20	8.7	19.6	99.0
0046603	5 G 0.5	20	9.4	24.5	119.0
0046604	7 G 0.5	20	10.2	34.3	142.0
0046612	2 X 1	18	8.4	19.2	93.0
0046613	3 G 1	18	8.9	28.8	110.0
0046614	4 G 1	18	9.6	38.4	133.0
0046615	5 G 1	18	10.6	48.0	160.0
0046616	7 G 1	18	11.4	67.2	195.0
0046617	12 G 1	18	15.2	115.2	345.0
0046618	2 X 1.5	16	9.0	28.8	113.0
0046619	3 G 1.5	16	9.5	43.2	135.0
0046620	4 G 1.5	16	10.4	57.6	165.0
0046621	5 G 1.5	16	11.4	72.0	200.0
0046622	7 G 1.5	16	12.3	100.8	246.0
0046623	12 G 1.5	16	16.5	172.8	437.0
0046625	18 G 1.5	16	19.2	259.2	613.0
0046626	25 G 1.5	16	23.4	360.0	904.0
0046628	2 X 2.5	14	9.8	48.0	146.0
0046629	3 G 2.5	14	10.5	72.0	178.0
0046630	4 G 2.5	14	11.4	96.0	220.0
0046631	5 G 2.5	14	12.5	120.0	269.0
0046633	3 G 4	12	11.8	115.2	246.0
0046634	4 G 4	12	12.9	153.6	307.0
0046635	5 G 4	12	14.5	192.0	389.0
0046636	3 G 6	10	15.2	172.8	396.0

Part number	Number of cores and mm ² per conductor	AWG	Outer diameter mm	Copper index kg/km	Weight kg/km approx.
0046637	4 G 6	10	16.8	230.4	495.0
0046638	5 G 6	10	18.4	288.0	608.0
ÖLFLEX® HEAT 180 C UL/CSA - screened					
0046701	3 G 0.5	20	8.6	43.4	100.0
0046702	4 G 0.5	20	9.3	55.4	122.0
0046703	5 G 0.5	20	10.0	60.2	137.0
0046708	2 X 1	18	9.0	48.2	104.0
0046709	3 G 1	18	9.5	65.0	131.0
0046710	4 G 1	18	10.2	74.6	152.0
0046711	5 G 1	18	11.0	91.5	181.0
0046712	7 G 1	18	11.9	117.9	228.0
0046716	2 X 1.5	16	9.6	65.0	126.0
0046717	3 G 1.5	16	10.1	79.4	152.0
0046718	4 G 1.5	16	10.9	101.1	186.0
0046719	5 G 1.5	16	11.8	122.7	222.0
0046720	7 G 1.5	16	12.8	158.7	281.0
0046721	12 G 1.5	16	16.9	245.2	431.0
0046723	18 G 1.5	16	19.6	346.1	600.0
0046724	25 G 1.5	16	23.9	495.7	833.0
0046728	3 G 2.5	14	11.0	115.5	197.0
0046729	4 G 2.5	14	11.9	146.7	244.0
0046730	5 G 2.5	14	12.9	177.9	291.0
0046734	3 G 4	12	12.3	165.9	261.0
0046735	4 G 4	12	13.4	211.5	325.0
0046736	5 G 4	12	14.9	257.2	389.0
0046740	4 G 6	10	17.2	302.8	482.0
0046741	5 G 6	10	18.7	367.6	580.0
0046742	4 G 10	8	22.8	508.4	802.0

Copper price basis: EUR 150 / 100 kg

Please find our standard lengths at: www.lappkabel.de/en/cable-standardlengths

Packaging size: Coil ≤ 30 kg and ≤ 250 m, otherwise drum

Please specify the desired packaging size (e.g. 1 x 500 m drum or 5 x 100 m coils)

ÖLFLEX® HEAT 180 EWKF C

Screened silicone cables with increased mechanical properties



Info

- Proven notch resistant EWKF quality
- EMC compliant

Benefits

- Longer durability in harsh applications than conventional silicone cables
- Notch and tear resistant outer sheath material reduces mechanical damage
- Copper braiding assures EMC and screens against electromagnetic interference
- Good flexibility ease the installation where space is limited
- The use of EWKF silicone often can avoid the use of a steel wire armoured version

Application range

- Areas with high ambient temperatures and additionally high mechanical stress
- Typical fields of application
 - Steel-, cement-, ceramic and iron works
 - Bakery equipment and industrial furnaces
 - Electric motor industry
 - Sauna/solarium construction
 - Thermal and heating elements
 - Lighting technology
 - Ventilator engineering
 - Air conditioning technology
 - Galvanization technology
 - Polymer processing
 - Generator and transformer building
 - Wind turbine engineering

Product features

- Halogen-free and flame retardant (IEC 60332-1-2)
- Reduced smoke density
- Good hydrolysis and UV resistance
- Resistant against a multitude of oils, alcohols, vegetable and animal fats and chemical media
- EWKF Formula: Increased initial tear propagation and notch resistance

Approvals (Norm references)



Design

- Fine strands of tinned copper wires
- Cores twisted together
- Core insulation: Based on Silicone
- Silicone based inner sheath
- Tinned copper screen braiding, interleaved plastic foil wrapping
- Notch resistant silicone based EWKF outer sheath, colour black (RAL 9005)

Technical data

- Core identification code**
Up to 5 cores: According to VDE 0293-308 Appendix T9)
Starting at 6 cores: Black with white numbers
- Specific insulation resistance**
>200 GOhm x cm
- Conductor stranding**
Fine wire according to VDE 0295 Class 5/ IEC 60228 Class 5
- Minimum bending radius**
For flexible applications:
20 x cable diameter
Fixed installation: 6 x cable diameter
- Rated voltage**
U₀/U 300/500 V
- Test voltage**
2000 V
- Protective conductor**
G = with protective conductor GN/YE
X = without protective conductor
- Range of temperature**
-50 °C up to +180 °C
(adequate ventilation provided)

Part number	Number of cores and mm² per conductor	Outer diameter mm	Copper index kg/km	Weight kg/km approx.
ÖLFLEX® HEAT 180 EWKF C				
0046301	2 X 0.75	8.6	37.5	104.0
0046302	3 G 0.75	8.9	46.1	118.0
00463033	4 G 0.75	10.2	57.3	152.0
00463043	5 G 0.75	10.9	67.3	176.0
0046307	2 X 1	9.0	43.0	116.0
0046308	3 G 1	9.7	55.7	142.0
00463093	4 G 1	10.9	67.8	175.0
00463103	5 G 1	11.6	80.3	203.0
0046312	7 G 1	12.3	113.9	250.0
0046313	2 X 1.5	10.8	58.0	166.0
0046314	3 G 1.5	11.2	74.0	188.0
00463153	4 G 1.5	12.0	91.4	222.0
00463163	5 G 1.5	12.9	121.7	273.0
0046318	7 G 1.5	14.2	157.2	341.0
0046320	3 G 2.5	12.8	121.2	271.0
00463213	4 G 2.5	13.9	150.9	328.0
00463223	5 G 2.5	15.0	180.5	387.0
00463273	4 G 4	16.0	218.0	448.0
00463283	5 G 4	17.2	262.9	531.0
0046330	3 G 6	16.4	240.5	489.0
00463313	4 G 6	17.9	304.7	591.0
00463323	5 G 6	19.4	370.0	706.0

Copper price basis: EUR 150 / 100 kg
 Please find our standard lengths at: www.lappkabel.de/en/cable-standardlengths
 Packaging size: Coil ≤ 30 kg and ≤ 250 m, otherwise drum
 Please specify the desired packaging size (e.g. 1 x 500 m drum or 5 x 100 m coils)

Comparable products

- ÖLFLEX® HEAT 180 H05SS-F EWKF see page 53
- ÖLFLEX® HEAT 180 EWKF

Accessories

- SKINTOP® MS-SC-M see page 114
- SKINTOP® MS-SC
- SKINTOP® MS-SC-M BRUSH see page 115



Expanded ambient temperatures

FEP cables (-100°C up to +205°C)

ÖLFLEX® HEAT 205 MC



Info

- Highest chemical resistance

ÖLFLEX® HEAT 205 PTFE/FEP



Info

- EMC compliant

Benefits

- Thin outer diameters for maximum space and weight saving
- Low outgassing behaviour

Application range

- Various fields of industry wherever very high temperatures, aggressive chemical media or tight spaces rule out the use of conventional cables
- Typical fields of application
 - Industrial furnace construction
 - Foundries
 - Chemical industry
 - Power plant engineering
 - Paint shop line technology
 - Heating elements
 - Polymer processing
 - Wind turbine engineering

Product features

- -Outstanding resistance against acids, solvents, lacquers, petrol, oils and many other chemical media
- Difficult to inflame
- High dielectric strength and high abrasion resistance
- Low water absorption
- Resistant to microbes
- Adhesion free insulation
- Weather and ozone resistant
- Hydrophobic and dirt-repellent
- High elongation and tear resistance
- Resistant against hydraulic fluids

Approvals (Norm references)



Design

- **ÖLFLEX® HEAT 205 MC**
 - Fine wired strands of tinned copper wires
 - Core insulation: Based on FEP
 - Cores twisted together
 - FEP based outer sheath, colour black
- **ÖLFLEX® HEAT 205 PTFE/FEP**
 - Fine wired strands of tinned copper wires
 - Core insulation: Based on PTFE
 - Cores twisted together
 - Copper braiding, tinned
 - Outer sheath of FEP, colour white

Technical data



Core identification code
ÖLFLEX® HEAT 205 MC

Up to 5 cores:
Colour coded acc. to VDE 0293-308
Starting at 7 cores:
ÖLFLEX® colour code, see Appendix T7

ÖLFLEX® HEAT 205 PTFE/FEP

Blue, red, grey, black



Conductor stranding

Fine wire in accordance with VDE 0295, Class 5 / IEC 60228 Class 5 from 0.5 mm²



Minimum bending radius

For flexible applications:

15 x cable diameter

Fixed installation:

4 x cable diameter



Rated voltage

U_n/U 300/500 V



Test voltage

ÖLFLEX® HEAT 205 MC

2500 V

ÖLFLEX® HEAT 205 PTFE/FEP

C/C : 2500 V

C/S : 2000 V



Protective conductor

G = with protective conductor GN/YE

X = without protective conductor



Range of temperature

Fixed installation:

-100°C up to +205°C

Part number	Number of cores and mm ² per conductor	Outer diameter mm	Copper index kg/km	Weight kg/km approx.
ÖLFLEX® HEAT 205 MC				
0091200	2 X 0.25	3.1	5.0	17.2
0091201	3 G 0.25	3.3	7.5	22.2
00912023	4 G 0.25	3.6	10.0	27.5
0091210	2 X 0.5	3.7	9.8	21.6
0091211	3 G 0.5	3.9	14.7	32.8
00912123	4 G 0.5	4.3	19.6	44.4
0091220	2 X 0.75	4.3	14.4	31.5
0091221	3 G 0.75	4.6	21.6	46.1
00912223	4 G 0.75	5.1	29.0	57.9
0091230	2 X 1	4.7	19.0	41.6
0091231	3 G 1	5.0	29.0	55.6

Part number	Number of cores and mm ² per conductor	Outer diameter mm	Copper index kg/km	Weight kg/km approx.
00912323	4 G 1	5.5	38.0	70.0
0091100	3 G 1.5	5.8	43.0	70.0
00911033	4 G 1.5	6.3	58.0	98.0
00911013	5 G 1.5	7.0	72.0	117.0
0091102	7 G 1.5	7.6	101.0	184.0
0091236	3 G 2.5	6.9	72.0	86.0
00912353	4 G 2.5	7.6	96.0	115.0
00912373	5 G 2.5	8.4	120.0	144.0
00912423	4 G 4	9.3	154.0	180.0
00912433	5 G 4	10.3	192.0	225.0
ÖLFLEX® HEAT 205 PTFE/FEP				
30016373	4 X 0.75	5.9	49.0	78.0

Copper price basis: EUR 150 / 100 kg

Please find our standard lengths at: www.lappkabel.de/en/cable-standardlengths

Packaging size: Coil ≤ 30 kg and ≤ 250 m, otherwise drum

Please specify the desired packaging size (e.g. 1 x 500 m drum or 5 x 100 m coils)

Comparable products

ÖLFLEX® HEAT 205 MC

- ÖLFLEX® HEAT 260 MC see page 57

ÖLFLEX® HEAT 260 MC

Unscreened version for most extreme loads



ÖLFLEX® HEAT 260 C MC

Copper screened version for most extreme loads



Info

- Excellent chemical, thermal and electrical performance

Info

- Failure-free transmission in EMC critically environments

Benefits

- Space and weight saving installation due to thin cable diameters
- Stress tearing resistant under heavy thermal fluctuations
- Low outgassing behaviour
- Copper braiding of screened version complies with EMC requirements and protects against electromagnetic interference

Application range

- Various fields of industry wherever very high temperatures, aggressive chemical media or tight spaces rule out the use of conventional cables
- The use of ÖLFLEX® HEAT 260 in harsh environments like for instance in paint shop lines is a proved solution
- Typical fields of application
 - Industrial furnace construction
 - Foundries
 - Chemical industry
 - Power plant engineering
 - Paint shop line technology
 - Heating elements
 - Polymer processing
 - Wind turbine engineering

Product features

- -Outstanding resistance against acids, alkalis, solvents, synthetic liquids, lacquers, petrol, oils and many other chemical media
- Difficult to inflame
- High dielectric strength and high abrasion resistance
- Low water absorption
- Resistant to microbes
- Adhesion free insulation
- Weather and ozone resistant
- Hydrophobic and dirt-repellent
- High elongation resistance and tear strength
- Resists contact with liquid nitrogen
- Resistant against synthetic hydraulic fluids

Approvals (Norm references)



Design

ÖLFLEX® HEAT 260 MC

- Fine strands of nickel-plated copper wires
- Core insulation: Based on PTFE
- Cores twisted together
- PTFE based outer sheath, colour black

ÖLFLEX® HEAT 260 C MC

- Fine strands of nickel-plated copper wires
- Core insulation: Based on PTFE
- Cores twisted together
- Special wrapping
- Nickel plated copper braiding
- PTFE based outer sheath, colour black

Technical data

- Core identification code**
VDE 0293-308, see Appendix T9
- Specific insulation resistance**
> 1 TΩhm x cm
- Conductor stranding**
Fine wire according to VDE 0295 Class 5/ IEC 60228 Class 5
- Minimum bending radius**
For flexible applications:
15 x cable diameter
Fixed installation:
4 x cable diameter
- Rated voltage**
U₀/U 300/500 V
- Test voltage**
ÖLFLEX® HEAT 260 MC
2500 V
ÖLFLEX® HEAT 260 C MC
C/C : 2500 V
C/S : 2000 V
- Protective conductor**
G = with protective conductor GN/YE
X = without protective conductor
- Range of temperature**
Fixed installation:
-190°C up to +260°C
temporary: +300°C



Part number	Number of cores and mm² per conductor	Outer diameter mm	Copper index kg/km	Weight kg/km approx.
ÖLFLEX® HEAT 260 MC - unscreened				
0091300	2 X 0.5	3.9	9.6	22.0
0091301	3 G 0.5	4.1	14.4	33.0
0091302	4 G 0.5	4.5	19.2	45.0
0091305	2 X 0.75	4.2	14.4	32.0
0091306	3 G 0.75	4.4	21.6	47.0
0091307	4 G 0.75	5.1	28.8	58.0
0091310	2 X 1	4.8	19.2	42.0
0091311	3 G 1	5.1	28.8	56.0
0091312	4 G 1	5.8	38.4	71.0
0091315	3 G 1.5	5.6	43.2	72.0
0091316	4 G 1.5	6.1	57.6	98.0
0091317	5 G 1.5	7.0	72.0	118.0
0091320	3 G 2.5	7.1	72.0	87.0

Part number	Number of cores and mm² per conductor	Outer diameter mm	Copper index kg/km	Weight kg/km approx.
0091321	4 G 2.5	7.7	96.0	116.0
0091322	5 G 2.5	8.3	120.0	145.0
ÖLFLEX® HEAT 260 C MC - screened				
0091330	3 G 0.75	5.5	46.0	75.0
0091331	4 G 0.75	5.9	51.0	87.0
0091332	3 G 1	5.8	48.0	81.0
0091333	4 G 1	6.4	65.0	104.0
0091334	3 G 1.5	6.3	65.0	101.0
0091335	4 G 1.5	7.2	86.0	134.0
0091336	5 G 1.5	7.8	105.0	162.0
0091337	3 G 2.5	7.9	114.0	160.0
0091338	4 G 2.5	8.7	153.0	204.0
0091339	5 G 2.5	9.4	209.0	270.0

Copper price basis: EUR 150 / 100 kg
 Please find our standard lengths at: www.lappkabel.de/en/cable-standardlengths
 Packaging size: Coil ≤ 30 kg and ≤ 250 m, otherwise drum
 Please specify the desired packaging size (e.g. 1 x 500 m drum or 5 x 100 m coils)

Comparable products

ÖLFLEX® HEAT 260 MC

- ÖLFLEX® HEAT 205 MC see page 56



Expanded ambient temperatures

PTFE cables (-190°C up to +260°C)

ÖLFLEX® HEAT 260 GLS

Steel armoured PTFE cables for increased mechanical stress



Info

- Good thermal and mechanical performance
- Germanischer Lloyd approval

Benefits

- Close-meshed braid made of galvanised steel wires protects against mechanical damaging
- Thin outer diameters for maximum space and weight saving
- Germanischer Lloyd approval for use at ship diesel engines

Application range

- Extremely high temperatures in addition with mechanical stress require special insulated and armoured cables
- Main applications
 - Ship building
 - Signal systems
 - Monitoring devices
 - Diesel engines
 - Steam boiler units
 - Turbine manufacture

Product features

- Difficult to inflame
- Resistant to stress tearing under heavy temperature fluctuations
- High dielectric strength and high abrasion resistance
- High elongation resistance and tear strength
- Only suitable for installation in dry conditions

Approvals (Norm references)



Design

- Fine strands of nickel-plated copper wires
- PTFE core insulation
- Cores twisted together
- Impregnated glass fibre braiding
- Galvanised steel wire braiding

Technical data



Core identification code

Up to 5 cores:
colour coded according VDE 0293-308, see Appendix T9
7-core version:
gn/ye, bl, bn, bk, bk, bk, tr



Approvals

GL (Germanischer Lloyd)



Specific insulation resistance

> 1 TΩm x cm



Conductor stranding

Fine wire according to VDE 0295 Class 5/ IEC 60228 Class 5



Minimum bending radius

In fixed installations:
5 x cable diameter



Rated voltage

U₀ / U 300/500V
according to GL: 250 V



Test voltage

1500 V



Protective conductor

G = with protective conductor GN/YE
X = without protective conductor



Range of temperature

Fixed installation:
-190°C up to +260°C
In accordance with GL: +205 °C

Part number	Number of cores and mm ² per conductor	Outer diameter mm	Copper index kg/km	Weight kg/km approx.
ÖLFLEX® HEAT 260 GLS				
0091120	2 X 1.5	5.7	29.0	93.0
0091121	3 G 1.5	6.1	43.0	102.0
00911223	4 G 1.5	6.6	58.0	130.0
00911233	5 G 1.5	7.3	72.0	149.0
0091124	7 G 1.5	8.0	101.0	180.0

Copper price basis: EUR 150 / 100 kg

Please find our standard lengths at: www.lappkabel.de/en/cable-standardlengths

Packaging size: Coil ≤ 30 kg and ≤ 250 m, otherwise drum

Please specify the desired packaging size (e.g. 1 x 500 m drum or 5 x 100 m coils)

Comparable products

- ÖLFLEX® HEAT 180 GLS



Source: PowerWind GmbH

ÖLFLEX® HEAT 145 SC

Electron beam cross-linked cores for increased application requirements



Info

- Improved characteristics in case of fire
- For thermal class B applications

Benefits

- Safety in areas with high personnel concentration
- Reduction of flame propagation and density and toxicity of smoke gases in event of fire
- Minimizes damage to buildings and equipment caused by the formation of toxic acid fumes in fires
- Several approvals for maritime application

Application range

- Suitable for wiring respectively connection of lighting, heating appliances, switch gear cabinets and distributors in mechanical engineering and plant construction

Product features

- Halogen-free according to IEC 60754-1
- Flame retardant according to IEC 60332-1-2
- No flame propagation according to IEC 60332.3
- Good moisture, ozone- and UV resistance
- Abrasion resistant

Approvals (Norm references)



Design

- Fine strands of tinned copper wires
- Electron beam cross-linked polyolefin copolymer insulation

Technical data

- Core identification code**
see Footnote
- Approvals**
GL (Germanischer Lloyd)
DNV (Det Norske Veritas)
LR (Lloyd's Register of Shipping)
- Specific insulation resistance**
>2 TOhm x cm
- Conductor stranding**
Fine wire in accordance with VDE 0295, Class 5 / IEC 60228 Class 5 from 0.5 mm²
- Minimum bending radius**
Fixed installation:
4 x cable diameter
- Rated voltage**
Up to 1.0mm² U0/U 300/500 V
From 1.5mm² U0/U 450/750 V
0.6/1kV from 1.5mm² with fixed and protected installation
- Test voltage**
3500 V
- Range of temperature**
Fixed installation:
-55°C up to +125°C
Temporary: up to +145°C

Part number	Number of cores and mm ² per conductor	Outer diameter mm	Copper index kg/km	Weight kg/km approx.
ÖLFLEX® HEAT 145 SC 300/500 V				
0181...	0.25	1.6	2.4	5.0
0182...	0.5	1.9	4.8	8.0
0183...	0.75	2.2	7.2	11.0
0184...	1	2.5	9.6	14.0
ÖLFLEX® HEAT 145 SC 450/750 V				
0185...	1.5	3.0	14.4	21.0
0186...	2.5	3.7	24.0	33.0
0187...	4	4.2	38.4	49.0
0188...	6	4.8	57.6	69.0
0189...	10	6.3	96.0	120.0
0190...	16	7.3	154.0	180.0
0191...	25	9.6	240.0	290.0
0192...	35	11.7	336.0	400.0
0193...	50	13.0	480.0	570.0
0194...	70	15.0	672.0	800.0
0195...	95	17.3	912.0	1,040.0
0196...	120	19.2	1,152.0	1,310.0
0197...	150	21.4	1,440.0	1,640.0
0198...	185	23.6	1,776.0	2,050.0
0199...	240	26.7	2,304.0	2,620.0

Copper price basis: EUR 150 / 100 kg
 Please find our standard lengths at: www.lappkabel.de/en/cable-standardlengths
 Packaging size: Coil ≤ 30 kg and ≤ 250 m, otherwise drum
 Please specify the desired packaging size (e.g. 1 x 500 m drum or 5 x 100 m coils)
 Bitte ergänzen Sie die jeweilige Artikelnummer bei der Bestellung mit der Kennziffer für die Aderfarbe: 000 =GREENYELLOW / 001 =BLACK / 002 =BLUE / 003 =BROWN / 005 =YELLOW / 006 =GREEN / 007 =VIOLET / 009 =orange / 104 =RED / 105 =weiß / 106 =GREY / 114
 A few part number combinations are not yet included into our assortment. For valid combinations please see our Index of part numbers.
 Cross-Section 0.25mm² only available as 300 m box. Cross-Section 0.5mm² only available as 200 m box. Cross-Section 1.0 - 4mm² only available as 100 m box.

Comparable products

- ÖLFLEX® TRAFFIC 3GKW
- H05Z-K, H07Z-K 110°C



Expanded ambient temperatures

Silicone single cores (-50°C up to +180°C)

ÖLFLEX® HEAT 180 SiF



Info

- Fine wired conductor

ÖLFLEX® HEAT 180 SiF/GL



Info

- Glass fibre protection braiding

ÖLFLEX® HEAT 180 SiD



Info

- Solid copper conductor

ÖLFLEX® HEAT 180 SiZ



Info

- Twin conductor

ÖLFLEX® HEAT 180 FZLSi



Info

- High voltage ignition wire

Application range

- Areas with high ambient temperatures where conventional core insulation materials will embrittle after a short while
- Typical fields of application
 - Switchgear cabinet building
 - Appliances and apparatus engineering
 - Electric motor industry
 - Sauna/solarium construction
 - Thermal and heating elements
 - Lighting technology
 - Ventilator engineering
 - Air-conditioning technology
 - Oven construction
 - Polymer processing
 - Generator and transformer building

Product features

- Halogen-free in accordance with IEC 60754-1
- Resistant against a multitude of oils, alcohols, vegetable and animal fats and chemical media

Approvals (Norm references)



ÖLFLEX® HEAT 180 FZLSi

- Underlies due to increased voltage rating not the CE Low Voltage Directive

Design

ÖLFLEX® HEAT 180 SiF

- Fine strands of tinned copper wires
- Silicone based insulation

ÖLFLEX® HEAT 180 SiF/GL

- Fine strands of tinned copper wires
- Silicone based insulation
- Impregnated glass fibre braiding

ÖLFLEX® HEAT 180 SiD

- Tinned solid copper wire conductor
- Silicone based insulation

ÖLFLEX® HEAT 180 SiZ

- Fine strands of tinned copper wires
- Silicone based insulation
- Cores parallel with separating strip

ÖLFLEX® HEAT 180 FZLSi

- Fine strands of tinned copper wires
- Silicone based insulation

Technical data

- Specific insulation resistance**
>200 GOhm x cm
- Conductor stranding**
ÖLFLEX® HEAT 180 SiF
Fine wire in accordance with VDE 0295, Class 5 / IEC 60228 Class 5 from 0.5 mm²
ÖLFLEX® HEAT 180 SiD
Solid copper conductor
- Minimum bending radius**
Fixed installation: 6 x core diameter
One bend at end of core: 3 x cable diameter
- Rated voltage**
ÖLFLEX® HEAT 180 SiF
U_i/U 300/500 V
ÖLFLEX® HEAT 180 FZLSi
10 kV
- Test voltage**
ÖLFLEX® HEAT 180 SiF
2000 V
ÖLFLEX® HEAT 180 FZLSi
20 kV
- Range of temperature**
-50 °C up to +180 °C
(adequate ventilation provided)
Temporary: +200 °C

Part number	Number of cores and mm ² per conductor	Outer diameter mm	Copper index kg/km	Weight kg/km approx.
ÖLFLEX® HEAT 180 SiF hook-up wire				
0047...	0.25	1.9	2.4	5.4
0048...	0.5	2.1	4.8	8.1
0049...	0.75	2.4	7.2	11.3
0050...	1	2.5	9.6	13.7
0051...	1.5	2.8	14.4	18.8
0052...	2.5	3.4	24.4	30.2
0053...	4	4.2	38.0	47.7
0054...	6	5.0	58.0	70.9
0055...	10	6.6	96.0	119.7
0056...	16	7.4	154.0	187.4
0057...	25	9.2	240.0	289.9
0058...	35	10.3	336.0	398.7

Part number	Number of cores and mm ² per conductor	Outer diameter mm	Copper index kg/km	Weight kg/km approx.
0059...	50	12.2	480.0	559.3
0060...	70	14.2	672.0	766.1
0061...	95	16.6	912.0	1,031.2
0062...	120	18.0	1,152.0	1,284.9
0063...	150	20.0	1,440.0	1,563.2
0064...	185	22.5	1,776.0	1,915.0
ÖLFLEX® HEAT 180 SiF/GL hook-up wire with glass fibre braiding				
0065102	0.5	2.6	4.8	12.6
0065103	0.75	2.9	7.2	16.0
0065104	1	3.0	9.6	18.4
0065105	1.5	3.3	14.4	23.7
0065106	2.5	3.9	24.0	35.6
0065107	4	4.7	38.0	53.3
0065108	6	5.7	58.0	77.3
0065109	10	7.6	96.0	129.2
0065110	16	8.8	154.0	198.6
0065111	25	10.9	240.0	302.5
0065112	35	12.1	336.0	413.0
0065113	50	14.0	480.0	578.0
ÖLFLEX® HEAT 180 SiD solid hook-up wire				
0068...	0.5	2.0	4.8	7.7
0069...	0.75	2.2	7.2	10.4
0070...	1	2.3	9.6	12.8
0071...	1.5	2.6	14.4	18.0
0072...	2.5	3.2	24.0	28.9
0073...	4	3.9	38.0	45.4
0074...	6	4.4	58.0	64.5
ÖLFLEX® HEAT 180 SiZ twin conductor				
0065201	2 x 0.5	2.1 x 4.2	9.6	16.1
0065202	2 x 0.75	2.3 x 4.6	14.4	21.5
ÖLFLEX® HEAT 180 FZLSi high-voltage ignition wire				
2510001	1 (32 x 0,2)	7.0	9.6	60.0

Copper price basis: EUR 150 / 100 kg

Please find our standard lengths at: www.lappkabel.de/en/cable-standardlengths

Packaging size: Coil ≤ 30 kg and ≤ 250 m, otherwise drum

Please specify the desired packaging size (e.g. 1 x 500 m drum or 5 x 100 m coils)

Please complete the part number at ÖLFLEX® HEAT 180 SiF and SiD with following colour code: 000 = GREEN/YELLOW; 001 = BLACK; 002 = BLUE; 003 = BROWN; 004 = BEIGE; 005 = YELLOW; 006 = GREEN; 007 = VIOLET; 008 = PINK; 009 = ORANGE; 104 = RED; 105 = WHITE; 106 = GREY; ÖLFLEX® HEAT 180 SiF/GL : Colour WHITE with natural colour glass fiber braiding; ÖLFLEX® HEAT 180 SiZ and FZLSi : Colour RED

Also available on large spools and non-returnable barrels.

A few part number combinations are not yet included into our assortment. For valid combinations please see our Index of part numbers.



Source: PowerWind GmbH



ÖLFLEX® ROBOT 900 DP

Screened TPE-PUR robot cable, for flexing and torsion load



Info

- Bending and torsion: All-in-once

Benefits

- Space saving installation due to small cable diameters
- Warehouse available High-Tec Robot cables!
- Protected against water and dirt
- Wear-resistant

- Oil resistant
- Low adhesive surface
- Flame retardant

Approvals (Norm references)



- Usage in Power Chains: Please comply with the assembly guidelines Appendix T3

Design

- Fine or superfine strands of plain copper wire
- Core insulation: TPE
- Cores twisted in layers
- PTFE tape wrapping
- Screened version (DP): layer of tinned copper wires
- Polyurethane sheath (PUR), black (RAL 9005)

Application range

- Plant engineering
- Machine tools
- Automated handling equipment
- Multi-axis articulated robots
- In power chains or moving machine parts

Product features

- Abrasion and cut resistant
- Hydrolysis resistant

Technical data



Core identification code

Up to 0.34 mm²: DIN 47100 cores
Starting at 0.50 mm²: black cores with white printed numbers



Mutual capacitance

C/C approx. 100 nF/km
C/S approx. 120 nF/km



Peak working voltage

0.34 mm²: 350 V (not for high current purposes)



Based on

VDE 0281/0282
VDE 0812



Specific insulation resistance

> 20 GOhm x cm



Inductivity

Approx 0.7 mH/km



Conductor stranding

Fine wire or superfine wire



Torsion

Torsion load max.
Without screening: +/- 360° /m with screening (DP) +/- 180° /m



Minimum bending radius

Flexing: 15 x outer diameter
Static:
4 x cable diameter



Rated voltage

48 V AC
Starting at 0.5 mm² U0/U: 300/500 V



Test voltage

Up to 0.34 mm²: 1500 V
Starting at 0.5 mm²: 3000 V



Protective conductor

G = with protective conductor GN/YE
X = without protective conductor



Range of temperature

Flexing: -40°C up to +80°C
Fixed installation: -50°C up to +80°C
Core insulation: Capable of temporary overload up to +120 °C

Part number	Number of cores and mm ² per conductor	Outer diameter in mm approx.	Copper index kg/km	Weight kg/km approx.
ÖLFLEX® ROBOT 900 DP				
0028100	12 X 0,14 DP	6.7	42.5	69
0028105	3 X 2 X 0,14 DP	5.9	17.0	44
0028126	25 X 0,25 DP	11.1	103.5	183
0028135	4 X 0,34 DP	5.7	21.3	46
0028136	5 X 2 X 0,34 DP	9.1	64.4	114
0028195	12 G 1,5 DP	14.0	259.0	395

Copper price basis: EUR 150 / 100 kg

Please find our standard lengths at: www.lappkabel.de/en/cable-standardlengths

Packaging size: Coil ≤ 30 kg and ≤ 250 m, otherwise drum

Please specify the desired packaging size (e.g. 1 x 500 m drum or 5 x 100 m coils)

Comparable products

- ÖLFLEX® ROBOT F1 UL/CSA

Accessories

- SILVYN® RILL PA 12 see page 132

ÖLFLEX® ROBOT 900 P

TPE-PUR robot cable, for flexing and torsion load



Benefits

- Space saving installation due to small cable diameters
- Warehouse available High-Tec Robot cables!
- Protected against water and dirt
- Wear-resistant

Application range

- Plant engineering
- Machine tools
- Automated handling equipment
- Multi-axis articulated robots
- In power chains or moving machine parts

Product features

- Abrasion and cut resistant

- Hydrolysis resistant
- Oil resistant
- Low adhesive surface
- Flame retardant

Approvals (Norm references)



- Usage in Power Chains: Please comply with the assembly guidelines Appendix T3

Design

- Fine or superfine strands of plain copper wire
- Core insulation: TPE
- Cores twisted in layers
- PTFE tape wrapping
- Polyurethane sheath (PUR), black (RAL 9005)

Technical data

- Core identification code**
Up to 0.34 mm²: DIN 47100 cores
Starting at 0.50 mm²: black cores with white printed numbers
- Mutual capacitance**
C/C approx. 100 nF/km
C/S approx. 120 nF/km
- Peak working voltage**
0.34 mm²: 350 V (not for high current purposes)
- Based on**
VDE 0281/0282
VDE 0812
- Specific insulation resistance**
> 20 GOhm x cm
- Inductivity**
Approx 0.7 mH/km
- Conductor stranding**
Fine wire or superfine wire
- Torsion**
Torsion load max.
Without screening: +/- 360° /m with screening (DP) +/- 180° /m
- Minimum bending radius**
Flexing: 15 x cable diameter
Static:
4 x cable diameter
- Rated voltage**
48 V AC
Starting at 0.5 mm² U₀/U: 300/500 V
- Test voltage**
Up to 0.34 mm²: 1500 V
Starting at 0.5 mm²: 3000 V
- Protective conductor**
G = with protective conductor GN/YE
X = without protective conductor
- Range of temperature**
Flexing: -40°C up to +80°C
Fixed installation: -50°C up to +80°C
Core insulation: Capable of temporary overload up to +120 °C

Part number	Number of cores and mm ² per conductor	Outer diameter in mm approx.	Copper index kg/km	Weight kg/km approx.
ÖLFLEX® ROBOT 900 P				
0028110	7 X 0.25	6.2	16.8	48
0028116	25 X 0.25	10.2	60.0	141
0028188	2 X 0.34	5.0	7.0	27
0028145	18 G 0.5	11.2	86.4	120
0028146	25 G 0.5	13.3	120.0	254
0028160	4 G 0.75	6.6	28.8	63
0028164	14 G 0.75	11.4	100.8	199
0028170	2 X 1	6.2	19.2	47
0028171	3 G 1	6.5	29.0	61
0028172	4 G 1	7.2	38.4	76
0028174	7 G 1	9.3	67.2	131
0028176	12 G 1	11.5	115.2	216
0028185	16 G 1,0 + (2 X 1 DP)	16.5	195.0	376
0028178	18 G 1	13.2	172.8	287
0028186	23 G 1,0 + (2 X 1 DP)	17.3	262.0	470
0028180	25 G 1	16.4	240.0	433
0028190	34 G 1	19.9	326.4	571
0028191	41 G 1	22.3	393.6	705



Power chain applications

Torsion, articulated robot

Part number	Number of cores and mm ² per conductor	Outer diameter in mm approx.	Copper index kg/km	Weight kg/km approx.
0028198	18 G 1.5	15.8	259.2	446
0028181	3 G 2.5	9.3	72.0	136
0028182	4 G 2.5	10.1	96.0	171
0028400	3 G 16	21.4	460.8	721
0028187	3 G 25	26.2	720.0	1,178
0028189	3 G 35	28.8	1,008.0	1,559

Copper price basis: EUR 150 / 100 kg

Please find our standard lengths at: www.lappkabel.de/en/cable-standardlengths

Packaging size: Coil ≤ 30 kg and ≤ 250 m, otherwise drum

Please specify the desired packaging size (e.g. 1 x 500 m drum or 5 x 100 m coils)

■ **Comparable products**

- ÖLFLEX® ROBOT F1 UL/CSA

■ **Accessories**

- SILVYN® RILL PA 12 see page 132



Source: PowerWind GmbH



Info

- Harmonized (HAR)
- International use



H05RR-F

Info

- Harmonized (HAR)
- International use



H05RN-F

Info

- Harmonized (HAR)
- International use



H07RN-F



Benefits

H05RR-F

- Light duty rubber-sheathed cable
- For light workshop devices with light to medium stress

H05RN-F

- Medium duty, rubber sheathed cable
- For lightweight workshop tools subject to medium loads

H07RN-F

- Heavy-duty, rubber-sheathed cable
- High stresses
- Allowed up to 1000 V (0.6/1 kV) alternating voltage within protected and fixed installation
- Arrangements from single core rubber-sheathed cables H07RN-F can be used for short-circuit and short-to-ground proof installation in accordance with VDE 0100 Part 520

Application range

H05RR-F

- Hand-held equipment
- Dry and damp interiors, as well as for temporary outdoor use
- Light & Sound technology

H05RN-F

- Hand-held equipment
- Dry and damp interiors, as well as outdoor use

H07RN-F

- Hand-held equipment
- Tools and agricultural machinery

- Dry and damp interiors, as well as outdoors and temporary in industrial water
- Light & Sound technology

Product features

H05RR-F

- Flame retardant

H05RN-F

- Flame retardant according to IEC 60332-1-2
- Oil resistant according to EN 60811-2-1

H07RN-F

- Flame retardant according to IEC 60332-1-2
- Oil resistant according to EN 60811-2-1

Approvals (Norm references)



Design

H05RR-F

- Copper wire acc. to HAR bare or tinned
- Core insulation: Rubber Type EI 4
- Outer jacket of rubber Type EM 3

H05RN-F

- Copper wire acc. to HAR bare or tinned
- Core insulation: Rubber Type EI 4
- Outer jacket of rubber Type EM 2

H07RN-F

- Copper wire acc. to HAR bare or tinned
- Core insulation: Rubber Type EI 4
- Outer jacket of rubber Type EM 2

Technical data

Core identification code
Up to 5 cores: According to VDE 0293-308 Appendix T9)
Starting at 6 cores: Black with white numbers

Approvals
VDE 0282 Part 4 / HD 22.4 S4

Specific insulation resistance
1 GOhm x cm

Conductor stranding
Fine wire according to VDE 0295 Class 5/ IEC 60228 Class 5

Minimum bending radius
Flexible use: 6 x outer diameter

Rated voltage
H05RR-F
U₀/U: 300/500 V
H05RN-F
U₀/U: 300/500 V
H07RN-F
U₀/U: 450/750 V
in protected and fixed installations:
U₀/U: 600/1000 V

Test voltage
H05RR-F
2000 V
H05RN-F
2000 V
H07RN-F
2500 V

Protective conductor
G = with protective conductor GN/YE
X = without protective conductor

Current rating
According to VDE 0298 part 4 Tab. 11 and 13

Range of temperature
Flexible use: -25°C up to +60°C

Part number	Number of cores and mm ² per conductor	Outer diameter in mm approx.	Copper index kg/km	Weight kg/km approx.
H05RR-F U₀/U: 300/500 V				
1600203	2 X 0.75	5.7 - 7.4	14.4	61
1600207	3 G 0.75	6.2 - 8.1	21.6	75
1600204	2 X 1	6.1 - 8.0	19.0	73
1600208	3 G 1	6.5 - 8.5	29.0	86
16002113	4 G 1	7.1 - 9.3	38.0	105
1600205	2 X 1.5	7.6 - 9.8	29.0	115
1600200	3 G 1.5	8.0 - 10.4	43.0	135
16002013	4 G 1.5	9.0 - 11.6	58.0	165
16002023	5 G 1.5	9.8 - 12.7	72.0	190
1600206	2 X 2.5	9.0 - 11.6	48.0	160
1600209	3 G 2.5	9.6 - 12.4	72.0	190
16002123	4 G 2.5	10.7 - 13.8	96.0	235
16002133	5 G 2.5	11.9 - 15.3	120.0	285



Harsh use conditions

Rubber cables

Part number	Number of cores and mm ² per conductor	Outer diameter in mm approx.	Copper index kg/km	Weight kg/km approx.
H05RN-F U0/U: 300/500 V (4 core version as S05RN-F)				
1600250	2 X 0.75	5.7 - 7.4	14.4	80
1600252	3 G 0.75	6.2 - 8.1	21.6	95
16002583	4 G 0.75	6.8 - 8.8	30.0	105
1600251	2 X 1	6.1 - 8.0	19.0	95
1600253	3 G 1	6.5 - 8.5	29.0	115
H07RN-F U0/U: 450/750 V				
1600117	3 G 1	8.3 - 10.7	29.0	130
1600199	2 X 1.5	8.5 - 11.0	29.0	135
1600103	3 G 1.5	9.2 - 11.9	43.0	165
16001233	4 G 1.5	10.2 - 13.1	58.0	200
16001043	5 G 1.5	11.2 - 14.4	72.0	240
1600151	7 G 1.5	14.0 - 17.5	101.0	385
1600148	12 G 1.5	17.6 - 22.4	173.0	516
1600259	19 G 1.5	20.7 - 26.3	274.0	800
1600166	24 G 1.5	24.3 - 30.7	346.0	882
1600263	25 G 1.5	25.1 - 25.9	360.0	918
1600187	2 X 2.5	10.2 - 13.1	48.0	195
1600118	3 G 2.5	10.9 - 14.0	72.0	235
16001053	4 G 2.5	12.1 - 15.5	96.0	290
16001293	5 G 2.5	13.3 - 17.0	120.0	345
1600152	7 G 2.5	16.5 - 20.0	168.0	520
1600154	12 G 2.5	20.6 - 26.2	288.0	810
1600156	19 G 2.5	25.5 - 31.0	456.0	1,200
1600157	24 G 2.5	28.8 - 36.4	576.0	1,650
1600186	2 X 4	11.8 - 15.1	77.0	270
1600119	3 G 4	12.7 - 16.2	115.0	320
16001063	4 G 4	14.0 - 17.9	154.0	395
16001303	5 G 4	15.6 - 19.9	192.0	485
1600161	7 G 4	21.0 - 21.8	268.8	681
1600120	3 G 6	14.1 - 18.0	173.0	495
16001073	4 G 6	15.7 - 20.0	230.0	610
16001313	5 G 6	17.5 - 22.2	288.0	760
1600121	3 G 10	19.1 - 24.2	288.0	880
16001083	4 G 10	20.9 - 26.5	384.0	1,060
16001093	5 G 10	22.9 - 29.1	480.0	1,300
1600122	3 G 16	21.8 - 27.6	461.0	1,090
16001103	4 G 16	23.8 - 30.1	614.0	1,345
16001113	5 G 16	26.4 - 33.3	768.0	1,680
16001123	4 G 25	28.9 - 36.6	960.0	1,995
16001133	5 G 25	32.0 - 40.4	1,200.0	2,470
1600124	3 G 35	29.3 - 37.1	1,008.0	1,900
16001143	4 G 35	32.5 - 41.1	1,344.0	2,645
16001363	5 G 35	37.0 - 45.0	1,680.0	2,810
16001153	4 G 50	37.7 - 47.5	1,920.0	3,635
1600126	5 G 50	40.0 - 50.8	2,400.0	4,050
16001163	4 G 70	42.7 - 54.0	2,688.0	4,830
16001283	4 G 95	48.4 - 61.0	3,648.0	6,320
16001323	4 G 120	53.0 - 66.0	4,608.0	6,830
16000883	4 G 150	58.0 - 73.0	5,760.0	8,320
1600141	4 G 185	64.0 - 80.0	7,104.0	9,800
1600183	4 G 240	72.0 - 91.0	9,216.0	12,100
Single core rubber cable H07RN-F U0/U: 450/750 V				
1600096	1 X 1.5	5.7 - 7.1	14.4	59
1600099	1 X 2.5	6.3 - 7.9	24.0	72
1600097	1 X 4	7.2 - 9.0	38.0	99
1600098	1 X 6	7.9 - 9.8	58.0	130
1600194	1 X 10	9.5 - 11.9	96.0	230
1600195	1 X 16	10.8 - 13.4	154.0	320
1600196	1 X 25	12.7 - 15.8	240.0	450
1600193	1 X 35	14.3 - 17.9	336.0	605
1600197	1 X 50	16.5 - 20.6	480.0	825
1600189	1 X 70	18.6 - 23.3	672.0	1,090
1600190	1 X 95	20.8 - 26.0	912.0	1,405
1600198	1 X 120	22.8 - 28.6	1,152.0	1,745
1600191	1 X 150	25.2 - 31.4	1,440.0	1,887
1600175	1 X 185	27.6 - 34.4	1,776.0	2,274
1600177	1 X 240	30.6 - 38.3	2,304.0	2,955
30015435	1 X 300	33.5 - 41.9	2,880.0	3,479

Copper price basis: EUR 150 / 100 kg

Please find our standard lengths at: www.lappkabel.de/en/cable-standardlengths

Packaging size: Coil ≤ 30 kg and ≤ 250 m, otherwise drum

Please specify the desired packaging size (e.g. 1 x 500 m drum or 5 x 100 m coils)

Cross-Section 5G35 and 5G50 without <HAR>

■ Comparable products

H05RN-F

- H07ZZ-F

H07RN-F

- H07ZZ-F
- ÖLFLEX® AQUA RN8

■ Accessories

H07RN-F

- EASY STRIP 2 stripping and cutting tool
- PWE 8.87 crimping pliers
- KS 20 cable shears
- SKINTOP® CLICK / CLICK-R see page 109

ÖLFLEX® H07BN4-F
Wind energy cable



Info

- Torsion resistant and very flexible

Benefits

- Special design for use in the tower

Application range

- Use in wind energy
- Mobile use as well as for fixed installation
- Dry and damp interiors, as well as outdoor use

Product features

- Flame retardant according to IEC 60332-1-2
- Torsion resistant up to +/-150°/mtr



- Oil resistant to most transmission oils
- Abrasion and cut resistant
- Cold flexible

Approvals (Norm references)



Design

- Strands of bare copper wires
- Core insulation: Rubber Type EI 7
- Outer jacket of special rubber compound based on EM 7

Technical data

	Approvals VDE 0282 Part 12 / HD 22.12
	Conductor stranding Extra fine wire in according to VDE 0295 Class 6 / IEC 60228 Class 6
	Minimum bending radius Flexible use: 6 x outer diameter Fixed installation: 5 x outer diameter
	Rated voltage U0/U: 450/750 V in protected and fixed installations: U0/U: 600/1000 V
	Test voltage 2500 V
	Current rating According to VDE 0298 Part 4
	Range of temperature Flexible use: -15°C up to +90°C Wind energy: -35°C up to +90°C Fixed installation: -35°C up to +90°C

Part number	Number of cores and mm ² per conductor	Outer diameter in mm approx.	Copper index kg/km	Weight kg/km approx.
ÖLFLEX® H07BN4-F				
1600715	1 X 95	22.4	912.0	1,230
1600716	1 X 120	24.3	1,152.0	1,490
1600717	1 X 150	27.2	1,440.0	1,875
1600718	1 X 185	29.3	1,776.0	2,190
1600719	1 X 240	32.6	2,304.0	2,900
1600720	1 X 300	36.0	2,880.0	3,400
1600721	1 X 400	40.0	3,840.0	4,400

Copper price basis: EUR 150 / 100 kg
Please find our standard lengths at: www.lappkabel.de/en/cable-standardlengths

Accessories

- V 1311 pressing pliers, hydraulic
- STAR STRIP stripping tool
- Cable shears KT 4 and KT 5



Source: PowerWind GmbH



Harsh use conditions

Rubber cables

NSGAFÖU



Benefits

- Suitable for high voltage
- Arrangements made of single core cables NSGAFÖU in accordance with VDE 0250 Part 602 with nominal voltage of at least U₀/U: 1,8/3,0 kV can be used for short-circuit and short-to-ground proof installation in acc. with VDE 0100 Part 520

Product features

- Flame retardant according to IEC 60332-1-2
- Oil resistant according to EN 60811-2-1

Approvals (Norm references)



Design

- Strands of tinned copper wires
- Core insulation: Rubber Type 3GI3
- Outer jacket of rubber Type 5GM3

Technical data

	Approvals VDE 0250 Part 602
	Conductor stranding Fine wire according to VDE 0295 Class 5/ IEC 60228 Class 5
	Minimum bending radius Flexible use: 10 x outer diameter Fixed installation: 6 x cable diameter
	Rated voltage U ₀ /U: 1,8 / 3,0 kV
	Test voltage 6000 V
	Current rating According to VDE 0298 Part 4, Table 15
	Range of temperature Flexible use: -25°C up to +90°C Fixed installation: -40°C up to +90°C

Application range

- Switch cabinets and equipment wiring
- Trains and buses
- Only for dry interiors

Part number	Conductor cross section in mm ²	Outer diameter in mm approx.	Copper index kg/km	Weight kg/km approx.
1600300	1.5	7.0	14.4	60
1600301	2.5	7.5	24.0	70
1600302	4	9.0	38.0	90
1600303	6	9.5	58.0	120
1600304	10	11.0	96.0	180
1600305	16	13.0	154.0	250
1600306	25	15.0	240.0	390
1600307	35	16.5	336.0	470
1600308	50	18.0	480.0	625
1600309	70	20.5	672.0	880
1600310	95	24.0	912.0	1,190
1600311	120	26.0	1,152.0	1,430
1600312	150	28.0	1,440.0	1,750
1600313	185	31.0	1,776.0	2,160
1600314	240	34.5	2,304.0	2,640
3026826	300	38.0	2,880.0	3,240

Copper price basis: EUR 150 / 100 kg
 Please find our standard lengths at: www.lappkabel.de/en/cable-standardlengths
 Packaging size: Coil ≤ 30 kg and ≤ 250 m, otherwise drum
 Please specify the desired packaging size (e.g. 1 x 500 m drum or 5 x 100 m coils)

Accessories

- V 1311 pressing pliers, hydraulic
- KS 20 cable shears

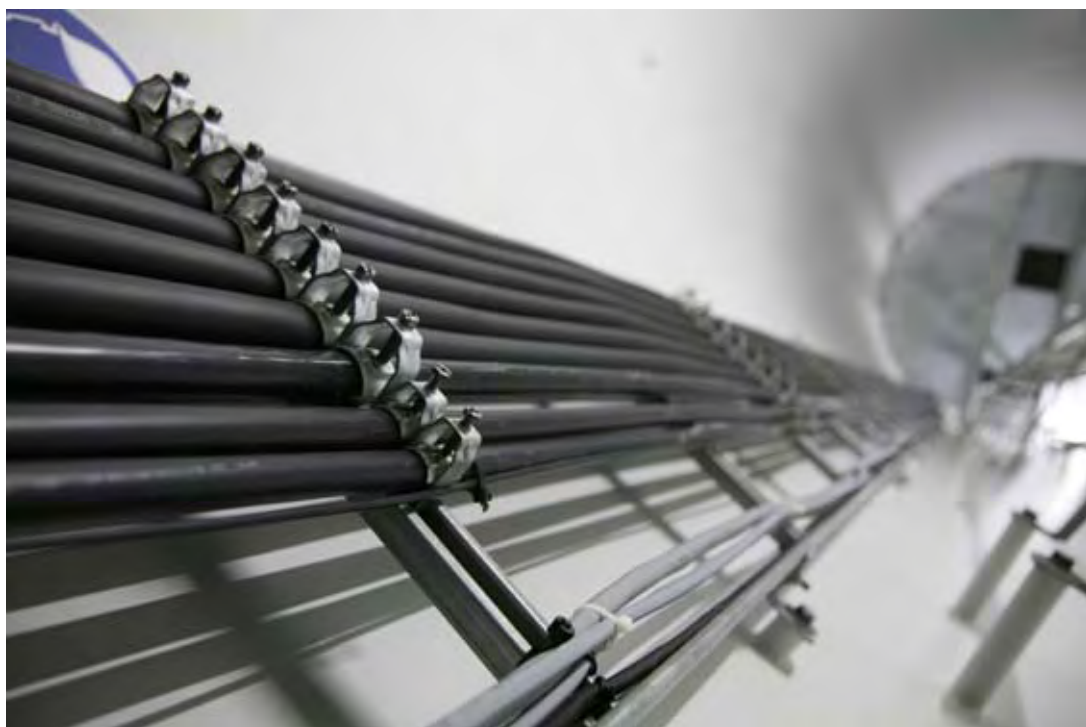

Source: PowerWind GmbH

H05V-K

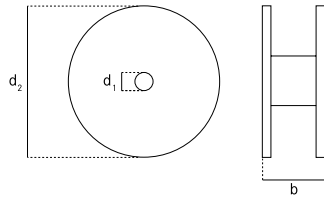

Application range

- Internal wiring of devices
- Protected laying in and on lights
- Signal systems in and on plaster in tubes

Product features

- Flame retardant according to IEC 60332-1-2

- Spool: d1=18mm; d2=200 mm; b=85 mm

Design

- Strands of bare copper wires
- Core insulation: Based on PVC

Technical data

	Approvals VDE 0281 / HD 21
	Specific insulation resistance > 20 GOhm x cm
	Conductor stranding Fine wire according to VDE 0295 Class 5 / IEC 60228 Class 5
	Rated voltage U ₀ /U: 300/500 V
	Test voltage 2000 V
	Current rating VDE 0298 Part 4
	Range of temperature Static: -30 °C up to +80 °C

Part number	Conductor cross section in mm ²	Outer diameter in mm approx.	m/Coil	m/Spool	Copper index kg/km
H05V-K					
4510..1S	0.5	2.1		250	4.8
4510..2S	0.75	2.4		250	7.2
4510..3S	1	2.6		250	9.6
4510..1	0.5	2.1	100		4.8
4510..2	0.75	2.4	100		7.2
4510..3	1	2.6	100		9.6

Copper price basis: EUR 150 / 100 kg

Please complete the part number with the following colour code: 00=GREEN/YELLOW; 01=BLACK; 02=BLUE (approx. RAL 5015); 03=BROWN; 04=RED; 05=WHITE; 06=GREY; 07=VIOLET; 08=PINK; 09=ORANGE; 10=TRANSPARENT (not harmonised, only X05V-K); 11=YELLOW; 12=GREEN; 14=DARKBLUE (approx. RAL 5010); 16=ULTRAMARINEBLUE (approx. RAL 5002); 92=DARKBLUE/WHITE (only coils)

A few part number combinations are not yet included into our assortment. For valid combinations please see our Index of part numbers.



H07V-K



Application range

- Laying in tubes, exposed and buried in plaster and in closed installation ducts
- For direct laying on racks, troughs and tubes only as equipotential binding conductor

Product features

- Flame retardant according to IEC 60332-1-2
- Spool: d1=18mm; d2=200 mm; b=85 mm

Design

- Strands of bare copper wires
- Core insulation: Based on PVC

Technical data

DIN VDE	Approvals VDE 0281 / HD 21
	Specific insulation resistance > 20 GOhm x cm
	Conductor stranding Fine wire according to VDE 0295 Class 5/ IEC 60228 Class 5
	Rated voltage U ₀ /U: 450/750 V
	Test voltage 2500 V
Amp.	Current rating VDE 0298 Part 4
	Range of temperature Static: -30°C up to +80°C

Part number	Conductor cross section in mm ²	Outer diameter in mm approx.	m/Coil	m/Spool	Copper index kg/km
H07V-K					
4520..1S	1.5	3.0		150	14.4
4520..2S	2.5	3.7		100	24.0
4520..1	1.5	3.0	100		14.4
4520..2	2.5	3.7	100		24.0
4520..3	4	4.3	100		38.4
4520..4	6	4.9	100		58.0
4520..5	10	6.5	100		96.0
4520..6	16	8.0	100		153.6
4521..1	25	9.8	100		240.0
4521..2	35	11.0	50		336.0
4521..3	50	13.0	50		480.0
4521..4	70	15.5	50		672.0
4521..5	95	17.0			912.0
4521..6	120	19.7			1,152.0
4521..7	150	21.3			1,440.0
4521..8	185	23.5			1,776.0
4521..9	240	27.4			2,304.0

Copper price basis: EUR 150 / 100 kg

Packaging size: Coil ≤ 30 kg, otherwise drum

Please complete the part number with the following colour code: 00=GREEN/YELLOW; 01=BLACK; 02=BLUE (approx. RAL 5015); 03=BROWN; 04=RED; 05=WHITE; 06=GREY; 07=VIOLET; 08=PINK; 09=ORANGE; 11=YELLOW (without HAR); 12=GREEN (without HAR); 14=DARKBLUE (approx. RAL 5010); 16=ULTRAMARINEBLUE (approx. RAL 5002); 92=DARKBLUE/WHITE (only coils)

A few part number combinations are not yet included into our assortment. For valid combinations please see our Index of part numbers.

Comparable products

- Multi-Standard single core UL(MTW)-CSA-HAR 1015
- Multi-Standard single core UL(MTW)-CSA-HAR 10269 see page 75

Accessories

- Mobile crimp tool crimping pliers
- DIN-assorted boxes conductor end sleeves
- PWE 8.87 crimping pliers
- FLEXIMARK® Collar Snap-on

NYY-J, NYY-O

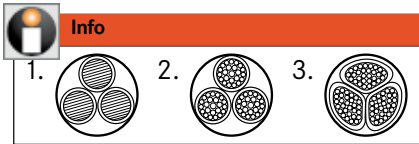

1. re = round conductor, single wire; 2. rm = round conductor, multi wire; 3. sm = sectorial conductor



Application range

- As a fixed installation power and control cable for the following applications:
- For indoor- and outdoor use
- Direct burial
- In concrete
- In water

Product features

- Flame retardant according to IEC 60332-1-2

Approvals (Norm references)



Design

- Conductor of bare copper wires
- Core insulation: Based on PVC
- Filling compound over the core assembly
- PVC based outer sheath

Technical data

- Core identification code**
Up to 5 cores: According to VDE 0293-308 Appendix T9)
Starting at 6 cores: Black with white numbers
- Approvals**
VDE 0276 Part 603 (for 1-5 cores)
VDE 0276 Part 627 (from 7 cores)
- Conductor stranding**
Single or multi-wire
- Minimum bending radius**
Single core: 15 x outer diameter
multi-core: 12 x outer diameter
- Rated voltage**
U₀/U: 0,6/1,0 kV
- Test voltage**
4000 V
- Range of temperature**
For installation: +5°C up to +50°C
Fixed installation: -40°C up to +70°C

Part number	Number of cores and mm ² per conductor	Outer diameter in mm approx.	Copper index kg/km	Weight kg/km approx.
NYY-J				
1550030	1 x 25,0 rm	13,0	240,0	380
1550038	1 x 35,0 rm	14,0	336,0	447
1550032	1 x 50,0 rm	15,0	480,0	650
1550033	1 x 70,0 rm	17,0	672,0	864
15500013	3 x 1,5 re	12,0	43,0	223
15500023	4 x 1,5 re	13,0	58,0	256
15500033	5 x 1,5 re	14,0	72,0	293
15500004	7 x 1,5 re	15,0	101,0	360
15500005	10 x 1,5 re	18,0	144,0	520
15500006	12 x 1,5 re	19,0	173,0	560
15500084	14 x 1,5 re	20,0	202,0	620
15500007	16 x 1,5 re	21,0	230,0	680
15500008	19 x 1,5 re	22,0	274,0	760
15500009	24 x 1,5 re	24,0	346,0	900
15500086	30 x 1,5 re	26,0	432,0	1,100
15500103	3 x 2,5 re	13,0	72,0	272
15500113	4 x 2,5 re	14,0	96,0	316
15500123	5 x 2,5 re	15,0	120,0	323
15500013	7 x 2,5 re	16,0	168,0	450
15500090	10 x 2,5 re	20,0	240,0	630
15500091	12 x 2,5 re	20,0	288,0	680
15500092	14 x 2,5 re	21,0	336,0	790
15500094	19 x 2,5 re	23,0	456,0	990
15500096	24 x 2,5 re	26,0	576,0	1,300
15500097	30 x 2,5 re	28,0	720,0	1,400
15500583	3 x 4,0 re	15,0	115,0	373
15500203	4 x 4,0 re	16,0	154,0	439
15500263	5 x 4,0 re	17,0	192,0	510
15500593	3 x 6,0 re	16,0	173,0	466
15500213	4 x 6,0 re	17,0	230,0	547
15500273	5 x 6,0 re	19,0	288,0	640
15500603	3 x 10,0 re	18,0	288,0	629
15500223	4 x 10,0 re	19,0	384,0	743
15500823	5 x 10,0 re	21,0	480,0	899
15500613	3 x 16,0 re	20,0	461,0	850
15500233	4 x 16,0 re	22,0	614,0	1,039
15500833	5 x 16,0 re	23,0	768,0	1,240
15500713	3 x 25,0 rm/ 16,0 re	25,0	874,0	1,595
15500243	4 x 25,0 rm	27,0	960,0	1,620
15500153	3 x 35,0 sm/ 16,0 re	27,0	1,162,0	1,718
15500753	4 x 35,0 sm	27,0	1,344,0	1,916
15500163	3 x 50,0 sm/ 25,0 rm	31,0	1,680,0	2,383
15500253	4 x 50,0 sm	31,0	1,920,0	2,639
15500173	3 x 70,0 sm/ 35,0 sm	33,0	2,352,0	3,196
15500763	4 x 70,0 sm	35,0	2,688,0	3,576
15500183	3 x 95,0 sm/ 50,0 sm	38,0	3,216,0	4,271
15500773	4 x 95,0 sm	40,0	3,648,0	4,746
15500723	3 x 120,0 sm/ 70,0 sm	41,0	4,128,0	5,281
15500783	4 x 120,0 sm	43,0	4,608,0	5,813
15500733	3 x 150,0 sm/ 70,0 sm	46,0	4,992,0	6,408
15500793	4 x 150,0 sm	48,0	5,760,0	7,263
15500743	3 x 185,0 sm/ 95,0 sm	50,0	6,240,0	7,909
15500803	4 x 185,0 sm	53,0	7,104,0	8,905
15500193	3 x 240,0 sm/ 120,0 sm	57,0	8,064,0	10,162
15500813	4 x 240,0 sm	60,0	9,216,0	11,430
NYY-O				
1550205	1 x 10,0 re	10,0	96,0	176
1550206	1 x 16,0 re	11,0	154,0	239
1550207	1 x 25,0 rm	13,0	240,0	380
1550208	1 x 35,0 rm	14,0	336,0	447



Building Installation

Cables for direct burial

Part number	Number of cores and mm ² per conductor	Outer diameter in mm approx.	Copper index kg/km	Weight kg/km approx.
1550209	1 x 50,0 rm	15.0	480.0	650
1550210	1 x 70,0 rm	17.0	672.0	864
1550211	1 x 95,0 rm	19.0	912.0	1,132
1550212	1 x 120,0 rm	21.0	1,152.0	1,405
1550213	1 x 150,0 rm	22.0	1,440.0	1,710
1550214	1 x 185,0 rm	24.0	1,776.0	2,086
1550215	1 x 240,0 rm	27.0	2,304.0	2,669
1550216	1 x 300,0 rm	30.0	2,880.0	3,305
1550218	1 x 500,0 rm	39.0	4,800.0	5,400
15502003	2 x 1,5 re	11.0	29.0	210
15502193	2 x 2,5 re	12.0	48.0	250
15502033	4 x 2,5 re	14.0	96.0	316
15502203	2 x 4,0 re	14.0	77.0	360
15502503	4 x 4,0 re	16.0	154.0	439
15502213	2 x 6,0 re	15.0	115.0	400
15502513	4 x 6,0 re	17.0	230.0	547
15502223	2 x 10,0 re	17.0	192.0	500
15502523	4 x 10,0 re	19.0	384.0	743
15502533	4 x 16,0 re	22.0	614.0	1,039
15502543	4 x 25,0 rm	27.0	960.0	1,620
15502553	4 x 35,0 sm	27.0	1,344.0	1,916
15502563	4 x 50,0 sm	31.0	1,920.0	2,639
15502573	4 x 70,0 sm	35.0	2,688.0	3,576
15502583	4 x 95,0 sm	40.0	3,648.0	4,746

Copper price basis: Excluding Copper

Please find our standard lengths at: www.lappkabel.de/en/cable-standardlengths

Packaging size: Coil ≤ 30 kg and ≤ 250 m, otherwise drum

Please specify the desired packaging size (e.g. 1 x 500 m drum or 5 x 100 m coils)

■ Comparable products

- NYCY see page 73
- NYCWY see page 73
- NAYY-J see page 74

■ Accessories

- V 1311 pressing pliers, hydraulic
- STAR STRIP stripping tool
- Cable shears KT 4 and KT 5



Source: PowerWind GmbH

NYCY



NYCWY



Application range

- As a fixed installation power and control cable for the following applications:
- For indoor- and outdoor use
- Direct burial
- In concrete
- In water

Approvals (Norm references)



Design

NYCY

- Conductor of bare copper wires

- Core insulation: Based on PVC
- Filling compound over the core assembly
- Concentric outside conductor of bare copper wires with counter spiral of copper band
- PVC based outer sheath

NYCWY

- Conductor of bare copper wires
- Core insulation: Based on PVC
- Filling compound over the core assembly
- Concentric outside conductor of bare copper wires, ceander-shaped, with counter spiral of copper band
- PVC based outer sheath

Technical data

Core identification code
Up to 5 cores: According to VDE 0293-308 Appendix T9)
Starting at 6 cores: Black with white numbers

Approvals
VDE 0276 Part 603 (for 1-5 cores)
VDE 0276 Part 627 (from 7 cores)

Conductor stranding
Single or multi-wire

Minimum bending radius
Fixed installation: 12 x outer diameter

Rated voltage
U₀/U: 0,6/1,0 kV

Test voltage
4000 V

Range of temperature
For installation: +5°C up to +50°C
Fixed installation: -40°C up to +70°C

Part number	Number of cores and mm ² per conductor	Outer diameter in mm approx.	Copper index kg/km	Weight kg/km approx.
NYCY				
15503003	2 x 1,5 re/ 1,5	14.0	52.0	245
15503103	3 x 1,5 re/ 1,5	14.0	66.0	280
15503203	4 x 1,5 re/ 1,5	15.0	81.0	302
1550330	7 x 1,5 re/ 2,5	17.0	133.0	450
1550332	12 x 1,5 re/ 2,5	20.0	205.0	580
1550337	24 x 1,5 re/ 6,0	26.0	413.0	1,100
15503113	3 x 2,5 re/ 2,5	15.0	104.0	316
15503213	4 x 2,5 re/ 2,5	16.0	128.0	360
1550350	7 x 2,5 re/ 2,5	18.0	200.0	530
1550355	16 x 2,5 re/ 6,0	23.0	451.0	950
15503223	4 x 4,0 re/ 4,0	18.0	200.0	485
15503233	4 x 6,0 re/ 6,0	19.0	297.0	616
NYCWY				
15505003	2 x 10,0 re/ 10,0	19.0	312.0	610
15505263	3 x 10,0 re/ 10,0	20.0	408.0	775
15505403	4 x 10,0 re/ 10,0	21.0	504.0	897
15505273	3 x 16,0 re/ 16,0	22.0	643.0	1,066
15505413	4 x 16,0 re/ 16,0	24.0	796.0	1,250
15505283	3 x 25,0 rm/ 25,0	26.0	1,003.0	1,584
15505423	4 x 25,0 rm/ 16,0	28.0	1,142.0	1,822
15505303	3 x 35,0 sm/ 35,0	26.0	1,402.0	1,710
15505433	4 x 35,0 sm/ 16,0	29.0	1,526.0	2,146
15505163	3 x 50,0 sm/ 50,0	30.0	2,000.0	2,368
15505443	4 x 50,0 sm/ 25,0	33.0	2,203.0	3,031
15505453	4 x 70,0 sm/ 35,0	38.0	3,082.0	4,056
15505143	3 x 95,0 sm/ 50,0	38.0	3,296.0	4,256
15505323	3 x 95,0 sm/ 95,0	39.0	3,791.0	4,600
15505463	4 x 95,0 sm/ 50,0	43.0	4,208.0	5,364
15505153	3 x 120,0 sm/ 70,0	41.0	4,236.0	5,314
15505473	4 x 120,0 sm/ 70,0	46.0	5,388.0	6,748
15505353	3 x 150,0 sm/ 70,0	45.0	5,100.0	6,344
15505483	4 x 150,0 sm/ 70,0	51.0	6,540.0	8,159
15505173	3 x 185,0 sm/ 95,0	50.0	6,383.0	8,054

Copper price basis: Excluding Copper
Please find our standard lengths at: www.lappkabel.de/en/cable-standardlengths
Packaging size: Coil ≤ 30 kg and ≤ 250 m, otherwise drum
Please specify the desired packaging size (e.g. 1 x 500 m drum or 5 x 100 m coils)

Comparable products

- NYJ, NYY-O see page 71

Accessories

NYCWY

- V 1311 pressing pliers, hydraulic
- Cable shears KT 4 and KT 5

New

NAYY-J



Application range

- As a fixed installation power and control cable for the following applications:
- For indoor- and outdoor use
- Direct burial
- In concrete
- In water

Product features

- Flame retardant according to IEC 60332-1-2
- Maximum tensile load for aluminium conductors is 30 N/mm²

Approvals (Norm references)



Design

- Conductor of aluminium
- Core insulation: Based on PVC
- Filling compound over the core assembly
- PVC based outer sheath

Technical data

- Core identification code**
According to VDE 0293-308 (table T9)
- Approvals**
VDE 0276 Part 603
- Conductor stranding**
Single wire
- Minimum bending radius**
Fixed installation: 12 x outer diameter
- Rated voltage**
U₀/U: 0,6/1,0 kV
- Test voltage**
4000 V
- Range of temperature**
For installation: +5°C up to +50°C
Fixed installation: -30°C to +70°C

Part number	Number of cores and mm ² per conductor	Outer diameter in mm approx.	Alu index kg/km	Weight kg/km approx.
NAYY-J				
1552010	4 x 35,0 re	28.2	406.0	1,170
1552011	4 x 50,0 se	29.8	580.0	1,305
1552012	4 x 70,0 se	34.2	812.0	1,730
1552013	4 x 95,0 se	38.6	1,102.0	2,205
1552014	4 x 120,0 se	41.9	1,392.0	2,655
1552015	4 x 150,0 se	45.6	1,740.0	3,150
1552016	4 x 185,0 se	50.8	2,146.0	3,925
1552017	4 x 240,0 se	59.6	2,784.0	4,880

Aluminium price basis: Excluding Aluminium
Please find our standard lengths at: www.lappkabel.de/en/cable-standardlengths

Comparable products

- NYY-J, NYY-O see page 71

Accessories

- V 1311 pressing pliers, hydraulic
- STAR STRIP stripping tool
- Tube Cable lugs and other connectors made of aluminium or bimetal AlCu are available on request



Source: PowerWind GmbH

Multi-Standard single core UL(MTW)-CSA-HAR 10269



Info

- Higher temperature range H07V2-K
- Higher voltage range according to UL



Multi-Standard single core UL(MTW)-CSA-HAR 10269

Benefits

- Usage on the most important global markets
- Reduced technical documentation expense
- Easier storage
- Increased economy in the production process

Application range

- Frequency converters
- Internal wiring of devices
- Control cabinet wiring

Product features

- Flame retardant according to IEC 60332-1-2

- Flame retardant according to UL VW1 / CSA FT1
- Oil resistant

Approvals (Norm references)



- NFPA 79 Edition 2007 conform

Design

- Strands of tinned copper wires
- Metrical cross section is the master size
- Core insulation: Based on Special PVC

Technical data

Approvals
 VDE 0281 / HD 21 (H07V2-K)
 UL: AWM Style 10269
 UL: MTW 1063
 CSA: TEW

Specific insulation resistance
 > 10 GOhm x cm

Conductor stranding
 Fine wire according to VDE 0295 Class 5 / IEC 60228 Class 5

Rated voltage
 HAR / IEC: U₀/U: 450/750 V
 UL (AWM): U: 1000 V
 UL (MTW): U: 600 V
 CSA (TEW): U: 600 V

Test voltage
 IEC: 2500 V AC
 UL: 4000 V AC
 Spark Test:
 10 kV, 22 - 2 AWG
 12,5 kV, 1 - 4/0 AWG

Range of temperature
 Fixed installation:
 HAR / IEC: -40°C up to +90°C
 UL (AWM): -40°C up to +105°C
 UL (MTW): -40°C to +90°C
 CSA (TEW): -40°C to +105°C

Part number	Conductor cross section in mm ²	Conductor cross section in AWG	Outer diameter in mm approx.	m/Coil	Copper index kg/km	Weight kg/km approx.
Multi-Standard single core UL(MTW)-CSA-HAR Style 10269						
41501..	0.5	22	2.5	100	4.8	10.0
41502..	0.75	20	2.7	100	7.2	12.5
41503..	1	18	2.9	100	9.6	16.0
41504..	1.5	16	3.1	100	14.4	20.0
41505..	2.5	14	3.7	100	24.0	31.0
41506..	4	12	4.4	100	38.4	45.0
41507..	6	10	4.9	100	58.0	63.0
41508..	10	8	6.8	100	96.0	120.0
41509..	16	6	8.9	100	154.0	185.0
41510..	25	4	10.1	100	240.0	260.0
41511..	35	2	11.4	50	336.0	360.0
41512..	50	1	14.0	50	480.0	535.0
41513..	70	2/0	15.8		672.0	735.0
41514..	95	3/0	18.1		912.0	930.0
41515..	120	4/0	19.4		1,152.0	1,160.0

Copper price basis: EUR 150 / 100 kg

Packaging size: Coil ≤ 30 kg, otherwise drum

Please complete the part number with the following colour code: 00=GREEN/YELLOW; 01=BLACK; 02=BLUE (approx. RAL 5015); 03=BROWN; 04=RED; 05=WHITE; 06=GREY; 07=VIOLET; 08=PINK; 09=ORANGE; 10=YELLOW (without HAR); 11=GREEN (without HAR); 14=DARKBLUE (approx. RAL 5010); 26=BLUE/WHITE (without HAR); 44=WHITE/BLUE (without HAR); 57=WHITE/YELLOW (without HAR); 85=WHITE/ORANGE (without HAR); Cross section 0,5mm²; 0,75mm²; 1,0mm²; 16mm²; 50mm² and 70mm² without HAR

A few part number combinations are not yet included into our assortment. For valid combinations please see our Index of part numbers.

Comparable products

- Multi-Standard single core UL(MTW)-CSA-HAR 1015

Accessories

- DIN-assorted boxes conductor end sleeves
- EASY STRIP 2 stripping and cutting tool
- PWE 8.87 crimping pliers
- FLEXIMARK® Collar Snap-on



Harnessed cables

Harnessed ground straps

Ground Straps / Flat Ground Straps

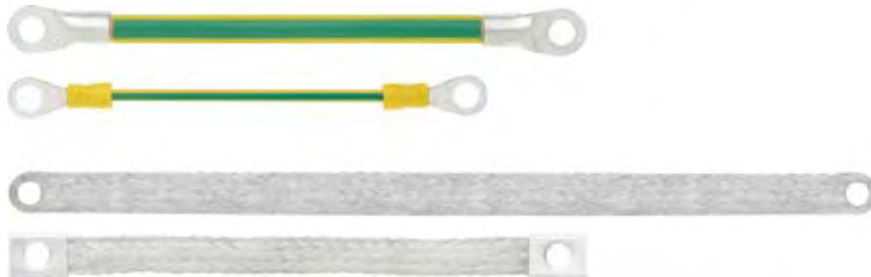

Application range

- Switch cabinet building
- The protective earth safety measure is prescribed by standard
- Fixed and moving metal parts such as doors in switch cabinet building must be earthed

Product features

- Fixed-lengths for M6 and M8 screws

Approvals (Norm references)



Design

- Ground Straps:
 - Strands of bare copper wires
 - PVC based core insulation
 - Harnessed with ring cable lugs
- Flat Ground Straps with sleeves:
 - Strands of tinned copper wires
 - Harnessed with pressed contact sleeves
- Flat Ground Straps with sleeves:
 - Strands of tinned copper wires
 - Welded ends

Technical data

- Core identification code**
Harnessed Ground Straps
green/yellow
- Conductor stranding**
Harnessed Ground Straps
IEC 60 228 Class 6
Harnessed Flat Ground Straps
IEC 60 228 Class 6, tinned
- Minimum bending radius**
Harnessed Ground Straps
7 x outer diameter
Harnessed Flat Ground Straps
5 x outer diameter
- Test voltage**
Harnessed Ground Straps
2500 V
- Range of temperature**
Harnessed Ground Straps
-30°C to +70°C
Harnessed Flat Ground Straps
-5°C to +70°C

Artikelnummer	Cross-section in mm ²	Type	For	Length in mm	Copper index kg/1000 pcs.	PU
Harnessed ground straps						
4571120	4	SZ 2564.000/EB	M6	170	6.5	5
4571121	16	SZ 2565.000/EB	M6	170	26.2	5
4571122	25	SZ 2566.000/EB	M6	170	40.8	5
4571123	4	SZ 2567.000/EB	M8	300	11.4	5
4571124	16	SZ 2568.000/EB	M8	300	46.2	5
4571125	25	SZ 2569.000/EB	M8	300	72.0	5
Harnessed Flat Ground Straps welded ends						
4571132	10	SZ 2412.210/FEP	M6	200	18.0	10
4571133	16	SZ 2412.216/FEP	M8	200	29.0	10
4571134	25	SZ 2412.225/FEP	M8	200	45.0	10
4571135	10	SZ 2412.310/FEP	M6	300	27.0	10
4571136	16	SZ 2412.316/FEP	M8	300	43.5	10
4571137	25	SZ 2412.325/FEP	M8	300	67.5	10
Harnessed Flat Ground Straps with sleeves						
4571126	10	SZ 2412.210/FEH	M6	200	18.0	10
4571127	16	SZ 2412.216/FEH	M8	200	29.0	10
4571128	25	SZ 2412.225/FEH	M8	200	45.0	10
4571129	10	SZ 2412.310/FEH	M6	300	27.0	10
4571130	16	SZ 2412.316/FEH	M8	300	43.5	10
4571131	25	SZ 2412.325/FEH	M8	300	67.5	10

Copper price basis: EUR 150 / 100 kg



Source: PowerWind GmbH

Fault free and efficient operation of wind turbines depends largely on continuous and reliable availability of data transmission.

Lapp offers you a strong brand with proven quality here.

UNITRONIC® data transmission systems

UNITRONIC® gives you reliability even for large data volumes. Lapp Kabel supplies an extensive range of data cables for fast and reliable transmission of large quantities of data. In addition, we offer tried and tested cable systems for reliable data communication between the slip ring and hub in wind turbine head stations.

UNITRONIC®

Data communication systems



UNITRONIC® LIYCY

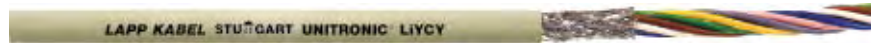

Application range

- Used for computer systems, MSR technology, office machinery, scales - screened cables with small dimensions.
- Dry and damp indoors

Product features

- Colour code in accordance with DIN 47100
- Flame retardant according to IEC 60332-1-2

Approvals (Norm references)



Design

- Bare copper wire stranded conductor
- PVC core insulation and outer sheath
- Screen made of tinned copper wire braid
- Colour: pebble grey (RAL 7032)

Technical data

- Core identification code**
DIN 47100 without colour repetition, see Appendix T9
- Mutual capacitance**
C/G approx. 140 nF/km
C/S approx. 150 nF/km
- Peak working voltage**
(not for power applications) 250 V
- Based on**
VDE 0812
- Specific insulation resistance**
> 20 GOhm x cm
- Inductivity**
approx. 0.65 mH/km
- Conductor stranding**
Strand, fine wire
0.34 mm², 7 wire
- Conductor resistance**
see Appendix T11
- Minimum bending radius**
For flexible applications:
15 x cable diameter
fixed installation:
6 x cable diameter
- Test voltage**
At 0.14 mm²: 1200 V
> 0.14 mm²: 1500 V
- Range of temperature**
Fixed installation: -40°C up to +80°C

Part number	Number of cores and mm ² per conductor	Outer diameter in mm approx.	Copper index kg/km	Weight kg/km approx.
UNITRONIC® LIYCY				
0034302	2 x 0.14	3.9	12.0	20.0
0034303	3 x 0.14	4.1	13.0	28.0
0034304	4 x 0.14	4.3	14.3	33.0
0034305	5 x 0.14	4.6	15.5	38.0
0034306	6 x 0.14	4.9	18.2	38.0
0034307	7 x 0.14	4.9	19.0	49.0
0034308	8 x 0.14	5.8	21.2	56.0
0034310	10 x 0.14	6.1	28.5	66.0
0034312	12 x 0.14	6.3	30.4	78.0
0034314	14 x 0.14	6.7	32.0	80.0
0034315	15 x 0.14	6.9	37.8	86.0
0034316	16 x 0.14	7.0	43.0	90.0
0034318	18 x 0.14	7.3	48.8	104.0
0034320	20 x 0.14	7.7	53.9	116.0
0034321	21 x 0.14	7.9	55.5	121.0
0034325	25 x 0.14	8.4	63.0	149.0
0034328	28 x 0.14	8.5	66.1	153.0
0034330	30 x 0.14	8.7	69.0	158.0
0034332	32 x 0.14	9.0	73.6	164.0
0034336	36 x 0.14	9.3	83.0	183.0
0034340	40 x 0.14	10.4	87.5	210.0
0034344	44 x 0.14	10.7	110.5	225.0
0034350	50 x 0.14	11.1	122.5	253.0
0034402	2 x 0.25	4.5	16.0	32.0
0034403	3 x 0.25	4.7	21.0	37.0
0034404	4 x 0.25	5.0	24.0	41.3
0034405	5 x 0.25	5.6	29.0	51.2
0034406	6 x 0.25	6.0	30.0	58.0
0034407	7 x 0.25	6.0	37.0	65.0
0034408	8 x 0.25	7.1	42.0	73.0
0034410	10 x 0.25	7.5	46.0	82.0
0034412	12 x 0.25	7.7	53.0	145.0
0034414	14 x 0.25	8.0	59.0	99.0
0034415	15 x 0.25	8.3	61.0	111.0
0034416	16 x 0.25	8.4	64.0	124.0
0034418	18 x 0.25	8.8	83.0	143.0
0034420	20 x 0.25	9.3	88.0	152.3
0034421	21 x 0.25	9.6	93.0	161.0
0034425	25 x 0.25	10.7	114.0	172.0
0034428	28 x 0.25	10.8	126.0	181.1
0034430	30 x 0.25	11.0	132.0	189.0
0034432	32 x 0.25	11.4	138.0	203.0
0034436	36 x 0.25	11.8	148.0	220.0
0034440	40 x 0.25	12.7	157.0	248.0
0034450	50 x 0.25	13.8	178.0	318.0
0034461	61 x 0.25	15.0	205.0	365.2
0034502	2 x 0.34	4.9	21.0	37.0
0034503	3 x 0.34	5.1	27.0	49.0
0034504	4 x 0.34	5.7	28.0	59.0
0034505	5 x 0.34	6.2	30.0	66.0
0034506	6 x 0.34	6.8	45.0	79.0
0034507	7 x 0.34	6.8	48.0	83.0
0034508	8 x 0.34	7.8	52.0	94.0
0034510	10 x 0.34	8.3	74.0	129.2
0034512	12 x 0.34	8.5	80.0	142.0

Part number	Number of cores and mm ² per conductor	Outer diameter in mm approx.	Copper index kg/km	Weight kg/km approx.
0034514	14 x 0.34	8.9	86.0	154.0
0034515	15 x 0.34	9.2	90.0	155.0
0034516	16 x 0.34	9.4	94.0	160.0
0034518	18 x 0.34	10.2	103.0	173.0
0034520	20 x 0.34	10.7	112.0	192.0
0034521	21 x 0.34	11.1	116.0	199.2
0034525	25 x 0.34	11.9	135.0	259.0
0034528	28 x 0.34	12.0	153.0	280.0
0034530	30 x 0.34	12.3	159.0	291.1
0034532	32 x 0.34	13.0	165.0	305.0
0034536	36 x 0.34	13.4	179.0	331.0
0034540	40 x 0.34	14.8	200.0	365.0
0034550	50 x 0.34	15.9	235.0	431.0
0034602	2 x 0.50	5.6	29.0	54.0
0034603	3 x 0.50	5.9	38.0	67.0
0034604	4 x 0.50	6.3	43.0	77.0
0034605	5 x 0.50	7.0	51.0	90.0
0034606	6 x 0.50	7.6	59.0	104.0
0034607	7 x 0.50	7.6	65.0	112.0
0034608	8 x 0.50	8.7	70.0	135.0
0034610	10 x 0.50	9.3	88.0	160.0
0034612	12 x 0.50	9.6	99.0	177.0
0034618	18 x 0.50	11.8	134.0	239.0
0034620	20 x 0.50	12.1	149.0	276.0
0034625	25 x 0.50	13.7	211.0	352.0
0034630	30 x 0.50	14.5	230.0	397.0
0034702	2 x 0.75	6.0	38.0	64.0
0034703	3 x 0.75	6.3	49.0	76.0
0034704	4 x 0.75	7.0	58.0	92.0
0034705	5 x 0.75	7.6	67.0	109.0
0034707	7 x 0.75	8.2	100.0	156.0
0034710	10 x 0.75	10.5	130.0	187.0
0034712	12 x 0.75	10.8	154.0	218.0
0034718	18 x 0.75	13.0	195.0	327.0
0034725	25 x 0.75	15.3	280.0	454.0
0034730	30 x 0.75	15.8	312.0	486.0
0034802	2 x 1.00	6.3	43.0	72.0
0034803	3 x 1.00	6.8	56.0	90.0
0034804	4 x 1.00	7.3	68.0	109.0
0034805	5 x 1.00	8.0	79.0	126.0
0034807	7 x 1.00	8.6	118.0	171.0
0034810	10 x 1.00	11.1	140.0	228.0
0034812	12 x 1.00	11.4	168.0	259.0
0034818	18 x 1.00	13.4	252.0	389.0
0034825	25 x 1.00	16.2	335.0	517.0
0034902	2 x 1.50	7.5	58.0	90.0
0034903	3 x 1.50	7.9	74.0	115.0
0034904	4 x 1.50	8.5	108.0	153.0
0034905	5 x 1.50	9.3	129.0	176.0
0034907	7 x 1.50	10.5	164.0	220.0
0034912	12 x 1.50	13.7	254.0	376.0
0034918	18 x 1.50	16.3	350.0	519.0
0034925	25 x 1.50	19.9	550.0	901.0

Copper price basis: EUR 150 / 100 kg
 Please find our standard lengths at: www.lappkabel.de/en/cable-standardlengths
 Packaging size: Coil ≤ 30 kg and ≤ 250 m, otherwise drum
 Please specify the desired packaging size (e.g. 1 x 500 m drum or 5 x 100 m coils)

- Comparable products**
- Li2YCY
 - Li5YC5Y

- Accessories**
- SKINTOP® MS-SC
 - Multipurpose shears A and B



Source: PowerWind GmbH



UNITRONIC® LiYY (TP)



Info

- TP = twisted pair

Benefits

- Highly resistant against acids, lyes and certain oils at room temperature

- Flame retardant according to IEC 60332-1-2

Approvals (Norm references)



Application range

- Electronic systems normally have little space available for cable installation. Short distances and small bending radius required.
- Dry and damp indoors

Design

- Bare copper wire stranded conductor
- PVC core insulation and outer sheath
- Twisted in pairs to considerably reduce decoupling. Often, no additional screening is required.
- Colour: pebble grey (RAL 7032)

Product features

- Colour code in accordance with DIN 47100

Technical data

- Core identification code**
DIN 47100, see Appendix T9
- Mutual capacitance**
Approx. 120 nF/km
- Peak working voltage**
(not for power applications)
at 0.14 mm²: 350 V
at >= 0.25 mm²: 500 V
- Based on**
VDE 0814: (DIN 47414)
or VDE 0812
- Specific insulation resistance**
> 20 GOhm x cm
- Coupling**
(1 kHz) approx. 300 pF at 100 m
- Inductivity**
approx. 0.65 mH/km
- Conductor stranding**
Fine copper wire strands
- Minimum bending radius**
For flexible applications: 10 x cable diameter
- Test voltage**
At 0.14 mm²: 1200 V
> 0.14 mm²: 1500 V
- Loop resistance**
2 x value in table conductor resistances, see Appendix T 11
- Range of temperature**
Fixed installation: -40°C up to +80°C
Flexing: -5°C up to +70°C

Part number	Number of pairs and conductor cross-section, mm ²	Outer diameter in mm approx.	Copper index kg/km	Weight kg/km approx.
UNITRONIC® LiYY (TP)				
0035101	2 x 2 x 0.14	4.8	5.4	25.5
0035102	3 x 2 x 0.14	4.9	8.0	32.0
0035103	4 x 2 x 0.14	5.5	10.7	38.5
0035104	5 x 2 x 0.14	5.7	13.4	45.5
0035105	6 x 2 x 0.14	6.2	16.1	51.0
0035108	10 x 2 x 0.14	8.0	26.9	77.5
0035110	12 x 2 x 0.14	8.2	32.3	94.5
0035113	16 x 2 x 0.14	9.1	43.0	110.5
0035160	2 x 2 x 0.25	6.1	9.6	38.0
0035161	3 x 2 x 0.25	6.2	14.4	48.0
0035162	4 x 2 x 0.25	6.9	19.2	59.0
0035163	6 x 2 x 0.25	7.8	28.8	80.0
0035164	8 x 2 x 0.25	9.2	38.4	98.0
0035165	10 x 2 x 0.25	10.3	48.0	115.0
0035170	2 x 2 x 0.5	7.9	19.2	72.0
0035171	3 x 2 x 0.5	8.0	28.8	83.0
0035172	4 x 2 x 0.5	8.7	38.4	115.0
0035174	8 x 2 x 0.5	12.2	76.8	206.0
0035175	10 x 2 x 0.5	13.2	96.0	247.0

Copper price basis: EUR 150 / 100 kg
 Please find our standard lengths at: www.lappkabel.de/en/cable-standardlengths
 Packaging size: Coil ≤ 30 kg and ≤ 250 m, otherwise drum
 Please specify the desired packaging size (e.g. 1 x 500 m drum or 5 x 100 m coils)

Comparable products

- For special applications with additional screening, we recommend the version UNITRONIC® LiYCY (TP)

UNITRONIC® LiYCY (TP)



UNITRONIC® LiYCY (TP)



Info

- TP = twisted pair

Benefits

- Data transmission with good screening, twisted pairs (TP) decouples the cable circuits

Application range

- Good protection against the capacitive influence due to electric fields (e.g. power cable)
- Dry and damp indoors

Product features

- Excellent screening against electrical interference
- Twisted core pairs are covered with an impervious copper braid

- Flame retardant according to IEC 60332-1-2

Approvals (Norm references)



Design

- Bare copper wire stranded conductor
- PVC core insulation and outer sheath
- TP structure
- Screen braiding made from tinned copper wire
- Colour: pebble grey (RAL 7032)

Technical data

- Core identification code**
DIN 47100, see Appendix T9
- Mutual capacitance**
C/C approx. 140 nF/km
C/S approx. 150 nF/km
- Peak working voltage**
(not for power applications)
at 0.14 mm²: 350 V
at >= 0.25 mm²: 500 V
- Based on**
VDE 0814: (DIN 47414)
or VDE 0812
- Specific insulation resistance**
> 20 GOhm x cm
- Coupling**
(1 kHz) approx. 300 pF at 100 m
- Inductivity**
approx. 0.65 mH/km
- Conductor stranding**
Fine copper wire strands
- Minimum bending radius**
Flexing:
15 x cable diameter
Fixed installation: 6 x cable diameter
- Test voltage**
At 0.14 mm²: 1200 V
> 0.14 mm²: 1500 V
- Loop resistance**
2 x value in table conductor resistances, see Appendix T 11
- Range of temperature**
Fixed installation: -40°C up to +80°C
Flexing: -5°C up to +70°C

Part number	Number of pairs and mm ² per conductor	Outer diameter in mm approx.	Copper index kg/km	Weight kg/km approx.
UNITRONIC® LiYCY (TP) MS				
0035131	2 x 2 x 0.14	5.7	18.5	39.0
0035141	3 x 2 x 0.14	5.8	23.0	48.0
0035132	4 x 2 x 0.14	6.2	26.6	54.0
0035133	6 x 2 x 0.14	7.1	48.5	85.0
0035150	8 x 2 x 0.14	8.2	53.7	97.0
0035134	10 x 2 x 0.14	8.7	59.0	110.0
0035135	12 x 2 x 0.14	8.9	66.0	142.0
0035136	16 x 2 x 0.14	10.2	79.0	154.0
0035142	20 x 2 x 0.14	11.3	97.0	184.0
0035137	25 x 2 x 0.14	12.5	113.0	238.0
0035800	2 x 2 x 0.25	7.0	28.0	54.0
0035801	3 x 2 x 0.25	7.1	39.6	66.0
0035802	4 x 2 x 0.25	7.6	44.9	81.0
0035803	6 x 2 x 0.25	8.5	69.5	115.0
0035804	8 x 2 x 0.25	10.3	76.9	130.0
0035805	10 x 2 x 0.25	11.0	102.0	158.0
0035806	12 x 2 x 0.25	11.3	120.0	190.0
0035807	16 x 2 x 0.25	12.5	146.5	238.0
0035808	25 x 2 x 0.25	16.1	205.0	344.0
0035810	2 x 2 x 0.5	8.6	48.1	93.0
0035811	3 x 2 x 0.5	8.7	73.7	129.0
0035812	4 x 2 x 0.5	9.4	82.0	146.0
0035813	6 x 2 x 0.5	11.1	110.0	198.0
0035814	8 x 2 x 0.5	13.1	139.0	259.0
0035816	12 x 2 x 0.5	14.9	198.3	354.0
0035817	16 x 2 x 0.5	16.5	240.0	459.0
0035820	2 x 2 x 0.75	8.5	58.0	106.0
0035821	3 x 2 x 0.75	9.4	84.0	140.0
0035822	4 x 2 x 0.75	10.7	108.0	179.0
0035827	5 x 2 x 0.75	11.1	126.0	215.0
0035823	6 x 2 x 0.75	12.1	146.0	246.0
0035824	8 x 2 x 0.75	14.7	180.0	305.0
0035825	12 x 2 x 0.75	16.2	261.0	456.0
0035830	2 x 2 x 1	10.3	84.0	142.0
0035831	3 x 2 x 1	10.4	96.0	173.0
0035832	4 x 2 x 1	11.3	121.0	212.0
0035836	5 x 2 x 1	11.8	161.0	266.0

Copper price basis: EUR 150 / 100 kg

Please find our standard lengths at: www.lappkabel.de/en/cable-standardlengths

Packaging size: Coil ≤ 30 kg and ≤ 250 m, otherwise drum

Please specify the desired packaging size (e.g. 1 x 500 m drum or 5 x 100 m coils)

Comparable products

- UNITRONIC® CY PiDY (TP)
- We recommend our UNITRONIC® CY PiDY (TP) if paired screening is required due to crosstalk attenuation.

Accessories

- SKINTOP® MS-SC-M see page 114
- Multipurpose shears A and B
- STAR STRIP stripping tool



UNITRONIC® PUR CP (TP)



Info

- TP = twisted pair

Benefits

- Twisted pair construction permits largely interference-free operation (decoupling).

Application range

- Everywhere, where robust and screened cables with small dimensions are necessary

Product features

- TP structure decouple circuits
- Copper braiding screens cable against electrical interference
- PUR outer sheath resistant against a multitude of oils

- Special notch and tear resistance
- Flame retardant according to IEC 60332-1-2

Approvals (Norm references)



Design

- Stranded bare conductor, PVC core insulation, core colours in accordance with DIN 47100, tin plated copper braid, PUR outer sheath, resistant to hydrolysis and microbes
- Colour: pebble grey (RAL 7032)

Technical data

- Core identification code**
DIN 47100 without colour repetition, see Appendix T9
- Mutual capacitance**
C/C approx. 140 nF/km
C/S approx. 150 nF/km
- Peak working voltage**
(not for power applications) 250 V
- Based on**
VDE 0814: (DIN 47414) or VDE 0812
- Insulation resistance**
> 20 GOhm x cm
- Coupling**
(1 kHz) approx. 300 pF at 100 m
- Inductivity**
approx. 0.65 mH/km
- Conductor stranding**
Fine copper wire strands
- Minimum bending radius**
Flexing:
15 x cable diameter
Fixed installation: 6 x cable diameter
- Test voltage**
At 0.14 mm²: 1200 V
> 0.14 mm²: 1500 V
- Loop resistance**
2 x value of table
Conductor resistances see Appendix T11
- Range of temperature**
Static:
-30°C up to +80°C
Flexing: -5°C up to +70°C

Part number	Number of pairs and conductor cross-section, mm ²	Outer diameter in mm approx.	Copper index kg/km	Weight kg/km approx.
UNITRONIC® PUR CP (TP)				
0032850	2 x 2 x 0.25	7.0	28.0	54.0
0032851	3 x 2 x 0.25	7.1	39.6	66.0
0032852	4 x 2 x 0.25	7.6	44.9	81.0
0032854	6 x 2 x 0.25	8.5	69.5	115.0
0032860	2 x 2 x 0.5	8.6	48.1	93.0
0032861	3 x 2 x 0.5	8.7	73.7	129.0
0032862	4 x 2 x 0.5	9.4	82.0	146.0
0032864	6 x 2 x 0.5	11.1	110.0	198.0
0032872	4 x 2 x 0.75	10.7	108.0	179.0
0032873	5 x 2 x 0.75	11.1	113.0	215.0

Copper price basis: EUR 150 / 100 kg
 Please find our standard lengths at: www.lappkabel.de/en/cable-standardlengths
 Packaging size: Coil ≤ 30 kg and ≤ 250 m, otherwise drum
 Please specify the desired packaging size (e.g. 1 x 500 m drum or 5 x 100 m coils)

Accessories

- SKINTOP® MS-SC-M see page 114
- SMARTSTRIP stripping tool

UNITRONIC® LiHH



Benefits

- Halogen-free data cable

Application range

- Suited for areas with a high density of people, e.g. public buildings or transport systems, as well as high-value property that must be protected in case of fire.
- Dry and damp indoors

Product features

- Robust outer sheath makes the cable resistant
- Have small outer diameters despite a high number of cores

- Flame retardant according to IEC 60332-1-2

Approvals (Norm references)



Design

- Stranded bare conductor, fine wire / 7-wire (only 0.34 mm²)
- Halogen-free core insulation
- Core colour code in accordance with DIN 47100 but no colour repetition
- Halogen-free outer sheath
- Colour: pebble grey (RAL 7032)

Technical data

- Core identification code**
DIN 47100, Appendix T9, without colour repetition
- Mutual capacitance**
Approx. 80 nF/km
- Peak working voltage**
(not for power applications) 250 V
- Based on**
VDE 0812
- Specific insulation resistance**
> 20 GOhm x cm
- Inductivity**
approx. 0.65 mH/km
- Conductor stranding**
Strand, fine wire
0.34 mm², 7 wire
- Conductor resistance**
see Appendix T11
- Minimum bending radius**
For flexible applications: 10 x cable diameter
- Test voltage**
1200 V
- Range of temperature**
Operation: -30 °C up to +70 °C

Part number	Number of cores and mm ² per conductor	Outer diameter in mm approx.	Copper index kg/km	Weight kg/km approx.
UNITRONIC® LiHH				
0037100	2 x 0.14	3.4	2.7	12.0
0037101	3 x 0.14	3.6	4.0	15.0
0037102	4 x 0.14	3.8	5.4	17.0
0037103	5 x 0.14	4.1	6.7	22.0
0037104	6 x 0.14	4.4	8.1	25.0
0037105	7 x 0.14	4.4	9.4	26.0
0037106	8 x 0.14	5.1	10.8	29.0
0037107	10 x 0.14	5.4	13.4	35.0
0037108	12 x 0.14	5.8	16.1	43.0
0037109	20 x 0.14	7.2	26.8	73.0
0037110	25 x 0.14	8.0	34.6	91.0
0037120	2 x 0.25	4.0	4.8	22.0
0037121	3 x 0.25	4.2	7.2	25.0
0037122	4 x 0.25	4.5	9.6	28.0
0037123	5 x 0.25	4.9	12.0	34.0
0037124	6 x 0.25	5.3	14.4	39.0
0037125	7 x 0.25	5.3	16.8	42.0
0037126	8 x 0.25	6.4	19.2	50.0
0037127	10 x 0.25	7.0	24.0	60.0
0037128	12 x 0.25	7.2	28.8	67.0
0037129	16 x 0.25	7.9	38.4	85.0

Part number	Number of cores and mm ² per conductor	Outer diameter in mm approx.	Copper index kg/km	Weight kg/km approx.
0037140	2 x 0.34	4.4	6.5	28.0
0037141	3 x 0.34	4.6	9.8	30.0
0037142	4 x 0.34	5.0	13.1	40.0
0037143	5 x 0.34	5.7	16.3	44.0
0037144	7 x 0.34	6.1	22.8	60.0
0037146	10 x 0.34	7.8	32.6	80.0
0037147	12 x 0.34	8.0	39.2	97.0
0037150	2 x 0.5	4.9	9.6	31.0
0037151	3 x 0.5	5.2	14.4	37.0
0037152	4 x 0.5	5.8	19.2	45.0
0037153	5 x 0.5	6.3	24.0	58.0
0037154	7 x 0.5	7.0	33.6	72.0
0037155	12 x 0.5	9.1	57.6	117.0
0037160	2 x 0.75	5.3	14.4	41.0
0037162	4 x 0.75	6.3	28.8	60.0
0037163	5 x 0.75	7.1	36.0	70.0
0037164	7 x 0.75	7.7	50.4	85.0
0037165	12 x 0.75	10.4	86.4	165.0
0037171	3 x 1	6.1	28.8	57.0
0037172	4 x 1	6.6	38.4	67.0
0037181	3 x 1.5	7.4	43.2	72.0
0037182	4 x 1.5	8.0	57.6	87.0

Copper price basis: EUR 150 / 100 kg
 Please find our standard lengths at: www.lappkabel.de/en/cable-standardlengths
 Packaging size: Coil ≤ 30 kg and ≤ 250 m, otherwise drum
 Please specify the desired packaging size (e.g. 1 x 500 m drum or 5 x 100 m coils)



UNITRONIC® LIHCH



Benefits

- Halogen-free data cable

Application range

- Suited for areas with a high density of people, e.g. public buildings or transport systems, as well as high-value property that must be protected in case of fire.

Product features

- Flame retardant according to IEC 60332-1-2

Approvals (Norm references)



Design

- Bare copper wire stranded conductor
- Halogen-free core insulation and outer sheath
- Core colour code in accordance with DIN 47100 but no colour repetition
- Screen made of tinned copper wire braid
- Colour: pebble grey (RAL 7032)

Technical data

- Core identification code**
DIN 47100 without colour repetition, see Appendix T9
- Mutual capacitance**
C/C approx. 80 nF/km
C/S approx. 120 nF/km
- Peak working voltage**
(not for power applications) 250 V
- Based on**
VDE 0812
- Insulation resistance**
> 20 GOhm x cm
- Coupling**
LIHCH (TP): At 1 kHz:
Approx. 300 pF/100 m
- Inductivity**
approx. 0.65 mH/km
- Conductor stranding**
Strand, fine wire
0.34 mm², 7 wire
- Conductor resistance**
see Appendix T11
- Minimum bending radius**
Flexing:
15 x cable diameter
Fixed installation: 6 x cable diameter
- Test voltage**
1200 V
- Loop resistance**
LIHCH (TP): 2x value in table T11
- Range of temperature**
Operation: -30 °C up to +70 °C

Part number	Number of cores and mm ² per conductor	Outer diameter in mm approx.	Copper index kg/km	Weight kg/km approx.
UNITRONIC® LIHCH				
0037302	2 x 0.14	4.1	12.0	22.0
0037303	3 x 0.14	4.3	14.1	25.0
0037304	4 x 0.14	4.5	15.9	29.0
0037306	6 x 0.14	5.1	22.0	35.0
0037307	7 x 0.14	5.1	24.0	38.0
0037308	8 x 0.14	6.0	26.0	41.0
0037312	12 x 0.14	6.5	30.4	78.0
0037316	16 x 0.14	7.2	43.0	90.0
0037325	25 x 0.14	8.7	63.0	149.0
0037402	2 x 0.25	4.7	15.0	25.0
0037403	3 x 0.25	4.9	18.0	30.0
0037404	4 x 0.25	5.2	22.0	35.0
0037406	6 x 0.25	6.2	30.0	49.0
0037407	7 x 0.25	6.2	32.0	52.0
0037408	8 x 0.25	7.3	35.0	58.0
0037410	10 x 0.25	7.7	42.0	81.0
0037425	25 x 0.25	10.9	114.0	172.0
0037502	2 x 0.34	5.1	17.0	30.0
0037503	3 x 0.34	5.3	21.0	35.0
0037504	4 x 0.34	5.9	25.0	42.0
0037505	5 x 0.34	6.4	30.0	53.0
0037507	7 x 0.34	7.0	42.0	73.0
0037508	8 x 0.34	8.0	45.0	84.0
0037510	10 x 0.34	8.5	63.0	101.0

Part number	Number of cores and mm ² per conductor	Outer diameter in mm approx.	Copper index kg/km	Weight kg/km approx.
0037516	16 x 0.34	9.6	94.0	160.0
0037525	25 x 0.34	12.1	144.0	259.0
0037602	2 x 0.5	5.8	29.0	38.0
0037603	3 x 0.5	6.1	35.0	47.0
0037604	4 x 0.5	6.5	45.0	67.0
0037605	5 x 0.5	7.2	50.0	76.0
0037606	6 x 0.5	7.8	59.0	84.0
0037607	7 x 0.5	7.8	68.0	91.0
0037608	8 x 0.5	8.9	75.0	135.0
0037610	10 x 0.5	9.5	93.0	131.0
0037612	12 x 0.5	9.8	99.0	177.0
0037618	18 x 0.5	11.7	134.0	239.0
0037625	25 x 0.5	13.9	211.0	352.0
0037702	2 x 0.75	6.2	35.0	45.0
0037703	3 x 0.75	6.5	46.0	69.0
0037704	4 x 0.75	7.2	56.0	80.0
0037705	5 x 0.75	7.8	70.0	99.0
0037707	7 x 0.75	8.3	90.0	120.0
0037802	2 x 1	6.5	43.0	72.0
0037803	3 x 1	7.0	56.0	90.0
0037804	4 x 1	7.5	68.0	109.0
0037807	7 x 1	8.8	118.0	171.0
0037902	2 x 1.5	7.7	58.0	90.0
0037903	3 x 1.5	8.1	74.0	115.0
0037905	5 x 1.5	9.5	129.0	176.0

Copper price basis: EUR 150 / 100 kg

Please find our standard lengths at: www.lappkabel.de/en/cable-standardlengths

Packaging size: Coil ≤ 30 kg and ≤ 250 m, otherwise drum

Please specify the desired packaging size (e.g. 1 x 500 m drum or 5 x 100 m coils)

Accessories

- SKINTOP® MS-SC-M see page 114
- Multipurpose shears A and B

UNITRONIC® UL/CSA



Info

- Types LiYY, LiYCY and LiYCY (TP)



Application range

- Wiring of devices, machines and plants intended for export to the North American market or countries in which largely UL-/CSA approved cables are used.

Product features

- Not for power application !
- Flame retardant according to IEC 60332-1

Approvals (Norm references)



Design

- Structure as for basic types LiYY, LiYCY and LiYCY (TP)
- Core insulation: Based on PVC, multi-coloured according to colour code DIN 47100, outer sheath PVC compound, outer sheath dark grey (chrome)

Technical data

- Approvals**
UL AWM Style 2464
CSA AWM I/II A
- Range of temperature**
Fixed installation: max. +80°C

Part number	Number of cores/pairs and AWG size	Number of cores/pairs and mm² per conductor	Outer diameter in mm approx.	Copper index kg/km	Weight kg/km approx.
UNITRONIC® LiYY UL/CSA					
0022403	3 x AWG26/7	3 x 0.14	3.8	4.0	19.7
0022404	4 x AWG26/7	4 x 0.14	4.0	5.3	23.0
0022405	5 x AWG26/7	5 x 0.14	4.3	7.0	25.0
0022408	8 x AWG26/7	8 x 0.14	5.1	11.2	34.0
0022412	12 x AWG26/7	12 x 0.14	5.7	17.0	47.0
0022416	16 x AWG26/7	16 x 0.14	6.3	22.4	58.0
0022421	21 x AWG26/7	21 x 0.14	7.1	29.4	63.0
0022502	2 x AWG24/7	2 x 0.23	4.0	4.1	26.2
0022505	5 x AWG24/7	5 x 0.23	4.8	10.3	39.4
0022508	8 x AWG24/7	8 x 0.23	5.7	16.5	52.5
0022512	12 x AWG24/7	12 x 0.23	6.6	24.7	72.2
0022602	2 x AWG22/7	2 x 0.34	4.8	6.7	32.8
0022603	3 x AWG22/7	3 x 0.34	5.0	10.2	35.0
0022604	4 x AWG22/7	4 x 0.34	5.4	13.3	45.9
0022605	5 x AWG22/7	5 x 0.34	5.9	16.6	55.8
0022607	7 x AWG22/7	7 x 0.34	6.4	23.3	68.9
0022608	8 x AWG22/7	8 x 0.34	7.0	26.6	75.5
0022612	12 x AWG22/7	12 x 0.34	8.5	40.8	103.0
0022616	16 x AWG22/7	16 x 0.34	9.5	53.2	131.2
0022624	24 x AWG22/7	24 x 0.34	11.3	81.6	190.0
0022632	2 x AWG20/7	2 x 0.5	5.3	11.2	29.0
0022642	2 x AWG19/19	2 x 0.75	5.9	15.0	48.0
UNITRONIC® LiYCY UL/CSA					
0044602	2 x AWG26/7	2 x 0.14	4.3	15.6	29.5
0044604	4 x AWG26/7	4 x 0.14	4.7	20.6	39.4
0044652	2 x AWG24/7	2 x 0.23	4.7	17.9	36.1
0044655	5 x AWG24/7	5 x 0.23	5.5	28.5	55.8
0044658	8 x AWG24/7	8 x 0.23	6.4	38.4	72.2
0044662	12 x AWG24/7	12 x 0.23	7.3	51.8	98.4
0044702	2 x AWG22/7	2 x 0.34	5.5	14.9	32.0
0044703	3 x AWG22/7	3 x 0.34	5.7	18.5	38.0
0044704	4 x AWG22/7	4 x 0.34	6.1	24.8	44.0
0044705	5 x AWG22/7	5 x 0.34	6.6	30.8	53.0
0044707	7 x AWG22/7	7 x 0.34	7.1	40.2	71.0
0044712	12 x AWG22/7	12 x 0.34	9.2	66.5	120.0
0044716	16 x AWG22/7	16 x 0.34	10.2	82.7	145.0
0044721	21 x AWG22/7	21 x 0.34	11.4	102.2	170.0
0044732	2 x AWG20/7	2 x 0.5	6.0	21.7	41.0
0044733	3 x AWG20/7	3 x 0.5	6.2	27.3	47.0
0044735	5 x AWG20/7	5 x 0.5	7.4	39.3	72.0
0044738	8 x AWG20/7	8 x 0.5	8.7	68.3	102.0
0044850	7 x AWG18/19	7 x 1	9.2	92.8	160.8
0044851	10 x AWG18/19	10 x 1	11.7	130.9	200.0
0044912	12 x AWG16/19	12 x 1.5	13.9	248.6	375.0
UNITRONIC® LiYCY (TP) UL/CSA					
0066202	2 x 2 x AWG26/7	2 x 2 x 0.14	5.7	25.3	45.9
0066204	4 x 2 x AWG26/7	4 x 2 x 0.14	6.4	34.4	52.5
0066205	5 x 2 x AWG26/7	5 x 2 x 0.14	7.0	39.5	68.9
0066208	8 x 2 x AWG26/7	8 x 2 x 0.14	7.9	53.0	95.1
0066210	10 x 2 x AWG26/7	10 x 2 x 0.14	8.8	71.4	111.6
0066212	12 x 2 x AWG26/7	12 x 2 x 0.14	9.1	78.2	124.7
0066216	16 x 2 x AWG26/7	16 x 2 x 0.14	10.1	118.3	150.9
0066232	2 x 2 x AWG24/7	2 x 2 x 0.23	6.1	24.5	57.0
0066233	3 x 2 x AWG24/7	3 x 2 x 0.23	6.4	26.8	62.0
0066234	4 x 2 x AWG24/7	4 x 2 x 0.23	6.9	33.5	70.0
0066235	5 x 2 x AWG24/7	5 x 2 x 0.23	7.5	46.3	91.0
0066238	2 x 2 x AWG22/7	2 x 2 x 0.34	7.4	24.7	45.0
0066239	3 x 2 x AWG22/7	3 x 2 x 0.34	7.8	34.4	64.0
0066240	4 x 2 x AWG22/7	4 x 2 x 0.34	8.7	41.5	75.0
0066242	2 x 2 x AWG20/7	2 x 2 x 0.5	8.2	49.7	93.0
0066243	3 x 2 x AWG20/7	3 x 2 x 0.5	8.9	58.4	102.0
0066244	4 x 2 x AWG20/7	4 x 2 x 0.5	9.8	71.5	120.0
0066262	2 x 2 x AWG19/19	2 x 2 x 0.75	9.0	64.2	140.0

Copper price basis: EUR 150 / 100 kg
 Please find our standard lengths at: www.lappkabel.de/en/cable-standardlengths
 Packaging size: Coil 152 m; Drum 305 m



UNITRONIC® 300 / UNITRONIC® 300 CY

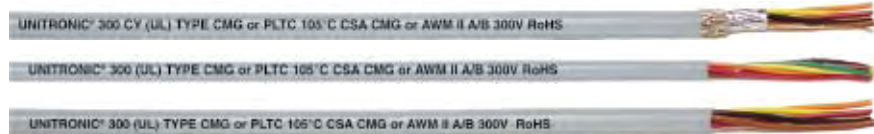

Info

- Unscreened + screened control and signal cables for industry
- PLTC = Power Limited Tray Cable

Benefits

- Several approvals, such as UL Type PLTC, UL CMG, UL Oil Res I, CSA CMG and CE.
- PLTC for open installation ("Exposed Run" / Open Wiring). Allows cabling without a cable duct.
- Cable UV resistant and approved for direct burial

Application range

- Control and signal cables for internal and external wiring

Approvals (Norm references)



Design

- Finely stranded tinned copper conductors
- PVC blended insulation
- UNITRONIC® 300 CY with overall foil tape wrap, drain wire, tinned copper braiding (75% coverage)
- Oil resistant grey PVC outer sheath

Technical data

- Core identification code**
see Data Sheet
- Approvals**
UL CMG, PLTC, Open Wiring, AWM 2464, Oil Res I
CSA CMG/FT4, CSA AWM II A/B, NOM SCFI 1994
- Minimum bending radius**
For installation: 4 x cable diameter
Screed: 6 x cable diameter
- Rated voltage**
According to UL: 300 V
IEC: not for power purposes
- Test voltage**
2000V
- Range of temperature**
-25°C to +105°C

Part number	Article designation	Number of cores and AWG size	Outer diameter in mm approx.	Copper index kg/km	Weight kg/km approx.
UNITRONIC® 300					
301602	UNITRONIC® 300	2 x AWG16	6.7	25.0	83.0
301802	UNITRONIC® 300	2 x AWG18	6.1	18.3	61.0
302006	UNITRONIC® 300	6 x AWG20	7.5	29.5	97.0
302015	UNITRONIC® 300	15 x AWG20	11.5	73.7	178.0
302020	UNITRONIC® 300	20 x AWG20	12.6	98.1	259.0
302025	UNITRONIC® 300	25 x AWG20	14.1	122.6	354.0
302204	UNITRONIC® 300	4 x AWG22	5.0	13.7	33.0
302210	UNITRONIC® 300	10 x AWG22	7.0	34.2	67.0
302215	UNITRONIC® 300	15 x AWG22	7.9	51.3	91.0
302220	UNITRONIC® 300	20 x AWG22	9.0	68.5	116.0
302225	UNITRONIC® 300	25 x AWG22	10.5	85.6	142.0
302410	UNITRONIC® 300	10 x AWG24	6.4	21.4	51.0
UNITRONIC® 300 CY					
301602S	UNITRONIC® 300 CY	2 x AWG16	7.6	50.6	101.0
301606S	UNITRONIC® 300 CY	6 x AWG16	9.9	105.7	210.0
301802S	UNITRONIC® 300 CY	2 x AWG18	6.8	37.2	75.0
301803S	UNITRONIC® 300 CY	3 x AWG18	7.3	49.1	85.0
301804S	UNITRONIC® 300 CY	4 x AWG18	7.9	59.6	104.0
301825S	UNITRONIC® 300 CY	25 x AWG18	16.8	278.4	448.0
302002S	UNITRONIC® 300 CY	2 x AWG20	6.3	28.3	60.0
302004S	UNITRONIC® 300 CY	4 x AWG20	7.3	40.2	88.0
302006S	UNITRONIC® 300 CY	6 x AWG20	8.4	55.1	119.0
302206S	UNITRONIC® 300 CY	6 x AWG22	6.4	20.5	68.0

Copper price basis: EUR 150 / 100 kg
 Please find our standard lengths at: www.lappkabel.de/en/cable-standardlengths
 Packaging size: Coil 152 m; Drum 305 m

Comparable products

- ÖLFLEX® TRAY II see page 41
- ÖLFLEX® TRAY II CY see page 42

- Universal strip stripping and cutting tool
- STAR STRIP stripping tool

UNITRONIC® FD



Application range

- Automated production processes require data transmission cables of ever more flexibility and durability
- UNITRONIC® FD series cables are especially suited for power chain use

Product features

- PVC outer sheath prevents mutual adhesion between several cables in the power chain
- Flame retardant according to IEC 60332-1-2

- Please observe the Installation Guidelines in Table T3.

Approvals (Norm references)



Design

- Stranded bare copper conductor, superfine
- PVC core insulation
- PVC outer sheath
- Colour: grey (RAL 7001)

Technical data

- Core identification code**
DIN 47100, see Appendix T9
- Mutual capacitance**
C/C approx. 140 nF/km
C/S approx. 150 nF/km
- Peak working voltage**
(not for power applications)
at 0.14 mm2: 350 V
at >= 0.25 mm2: 500 V
- Based on**
VDE 0812
- Specific insulation resistance**
> 20 GOhm x cm
- Inductivity**
approx. 0.65 mH/km
- Conductor stranding**
Strand, superfine wire in accordance with VDE 0295, single wire diameter 0.1 mm
- Conductor resistance**
see Appendix T11
- Minimum bending radius**
For flexible applications:
5 x cable diameter
- Test voltage**
1500 V
- Range of temperature**
Flexing: -5°C up to +70°C
fixed installation:
-40°C up to +70°C

Part number	Number of cores and mm ² per conductor	Outer diameter in mm max.	Copper index kg/km	Weight kg/km approx.
UNITRONIC® FD				
0027841	3 x 0.14	4.1	4.2	26.0
0027842	4 x 0.14	4.4	5.6	31.0
0027843	5 x 0.14	4.7	7.0	35.0
0027844	7 x 0.14	5.4	9.8	50.0
0027845	10 x 0.14	6.4	14.0	63.0
0027846	14 x 0.14	6.5	19.6	77.0
0027847	18 x 0.14	7.1	25.2	91.0
0027848	25 x 0.14	8.6	35.0	125.0
0027855	2 x 0.25	4.6	5.0	27.0
0027856	3 x 0.25	4.7	7.5	33.0
0027857	4 x 0.25	5.1	10.0	40.0
0027858	5 x 0.25	5.6	12.5	51.0
0027859	7 x 0.25	6.4	17.5	64.0
0027860	10 x 0.25	7.7	25.0	84.0
0027861	14 x 0.25	7.8	35.0	108.0
0027863	18 x 0.25	8.8	45.0	130.0
0027865	25 x 0.25	10.8	62.5	178.0
0027870	2 x 0.34	4.9	6.8	30.0
0027871	3 x 0.34	5.2	10.2	43.0
0027872	4 x 0.34	5.7	13.6	57.0
0027873	5 x 0.34	6.2	17.0	65.0
0027874	7 x 0.34	7.1	23.8	85.0
0027875	10 x 0.34	8.8	34.0	117.0
0027876	14 x 0.34	8.9	47.6	151.0
0027877	18 x 0.34	10.0	61.2	182.0
0027878	25 x 0.34	12.3	85.0	250.0

Copper price basis: EUR 150 / 100 kg
 Please find our standard lengths at: www.lappkabel.de/en/cable-standardlengths
 Packaging size: Coil ≤ 30 kg and ≤ 250 m, otherwise drum
 Please specify the desired packaging size (e.g. 1 x 500 m drum or 5 x 100 m coils)

Comparable products

- UNITRONIC® FD CY see page 88
- UNITRONIC® FD P plus UL/CSA see page 89

Accessories

- SILVYN® CHAIN



Highly flex.

UNITRONIC® FD CY



Application range

- UNITRONIC® FD series cables are especially suited for power chain use

Product features

- Highly flexible data transmission cable with copper braiding for power chain use
- PVC outer sheath prevents mutual adhesion between several cables in the power chain
- Flame retardant according to IEC 60332-1-2
- Please observe the Installation Guidelines in Table T3.

Approvals (Norm references)



Design

- Stranded bare copper conductor, superfine
- PVC core insulation
- Tinned copper braiding
- PVC outer sheath
- Colour: grey (RAL 7001)

Technical data

- Core identification code**
DIN 47100, see Appendix T9
- Mutual capacitance**
C/C approx. 140 nF/km
C/S approx. 150 nF/km
- Peak working voltage**
(not for power applications)
at 0.14 mm²: 350 V
at >= 0.25 mm²: 500 V
- Based on**
VDE 0812
- Specific insulation resistance**
> 20 GOhm x cm
- Inductivity**
approx. 0.65 mH/km
- Conductor stranding**
Strand, superfine wire in accordance with VDE 0295, single wire diameter 0.1 mm
- Conductor resistance**
see Appendix T11
- Minimum bending radius**
For flexible applications:
7.5 x cable diameter
- Test voltage**
1500 V
- Range of temperature**
Flexing: -5°C up to +70°C
fixed installation:
-40°C up to +70°C

Part number	Number of cores and mm ² per conductor	Outer diameter in mm max.	Copper index kg/km	Weight kg/km approx.
UNITRONIC® FD CY				
0027411	3 x 0.14	4.7	14.1	37.0
0027412	4 x 0.14	5.0	15.5	42.0
0027413	5 x 0.14	5.4	18.3	47.0
0027414	7 x 0.14	6.0	27.6	70.0
0027416	10 x 0.14	7.0	39.3	90.0
0027418	14 x 0.14	7.1	45.3	106.0
0027420	18 x 0.14	7.7	54.1	123.0
0027422	25 x 0.14	9.2	68.4	163.0
0027425	2 x 0.25	5.1	14.9	39.0
0027426	3 x 0.25	5.4	18.8	46.0
0027427	4 x 0.25	5.8	21.3	53.0
0027428	5 x 0.25	6.2	31.0	71.0
0027429	7 x 0.25	7.0	39.6	89.0
0027431	10 x 0.25	8.5	53.9	114.0
0027434	14 x 0.25	8.6	64.2	141.0
0027436	18 x 0.25	9.4	78.4	167.0
0027438	25 x 0.25	11.4	101.0	221.0
0027440	2 x 0.34	5.6	16.1	47.0
0027441	3 x 0.34	5.9	28.7	63.0
0027442	4 x 0.34	6.3	35.7	81.0
0027443	5 x 0.34	6.8	39.1	89.0
0027444	7 x 0.34	7.7	52.7	117.0
0027446	10 x 0.34	9.4	67.4	155.0
0027448	14 x 0.34	9.5	85.3	194.0
0027450	18 x 0.34	10.7	99.7	225.0
0027452	25 x 0.34	12.9	155.0	327.0

Copper price basis: EUR 150 / 100 kg

Please find our standard lengths at: www.lappkabel.de/en/cable-standardlengths

Packaging size: Coil ≤ 30 kg and ≤ 250 m, otherwise drum

Please specify the desired packaging size (e.g. 1 x 500 m drum or 5 x 100 m coils)

Comparable products

- UNITRONIC® FD CP plus UL/CSA see page 90

Accessories

- SKINTOP® MS-SC-M see page 114
- SILVYN® CHAIN
- STAR STRIP stripping tool

UNITRONIC® FD P plus UL/CSA

LAPP KABEL STUFGART UNITRONIC-FD® P plus UL/CSA e[UL] CMX 75 °C 26AWG

Benefits

- For power chain use

Application range

- Highly flexible data cable with PUR outer sheath, meets the highest service life requirements, even under rough climatic conditions, UL/CSA approved (CMX), ideal for the export-oriented machine manufacturer.

Product features

- PUR outer sheath, tear resistant and notch ductile, resistant to mineral oils and abrasion when used in power chains
- Temperatures up to -40°C possible

- Cable is halogen-free and has low capacitance
- Flame retardant according to IEC 60332-1-2
- Adhesion free, resistant to hydrolysis and microbes

Approvals (Norm references)



Design

- Stranded bare copper conductor, superfine
- Polyolefine core insulation
- PUR outer sheath
- Colour: grey (RAL 7001)

Technical data

- Core identification code**
DIN 47100, see Appendix T9
- Approvals**
CMX (UL/CSA)
- Mutual capacitance**
C/C approx. 60 nF/km
- Peak working voltage**
(not for power applications) 250 V
- Specific insulation resistance**
> 5 GOhm x km
- Inductivity**
approx. 0.65 mH/km
- Conductor stranding**
Strand, superfine wire in accordance with VDE 0295, single wire diameter 0.1 mm
- Conductor resistance**
see Appendix T11
- Minimum bending radius**
For flexible applications:
5 x cable diameter
- Test voltage**
1500 V
- Range of temperature**
-40°C up to 75°C

Part number	Number of cores and mm² per conductor	AWG size	Outer diameter in mm max.	Copper index kg/km	Weight kg/km approx.
UNITRONIC® FD P plus UL/CSA					
0028850	3 x 0.14	26 AWG	4.1	4.1	25.0
0028851	4 x 0.14	26 AWG	4.4	5.6	30.0
0028852	5 x 0.14	26 AWG	4.7	7.0	34.0
0028853	7 x 0.14	26 AWG	5.4	9.8	48.0
0028854	10 x 0.14	26 AWG	6.4	14.0	60.0
0028855	14 x 0.14	26 AWG	6.5	19.6	74.0
0028856	18 x 0.14	26 AWG	7.1	25.2	87.0
0028857	25 x 0.14	26 AWG	8.6	35.0	120.0
0028858	2 x 0.25	24 AWG	4.5	5.0	27.0
0028859	3 x 0.25	24 AWG	4.7	7.5	32.0
0028860	4 x 0.25	24 AWG	5.1	10.0	39.0
0028861	5 x 0.25	24 AWG	5.6	12.5	49.0
0028862	7 x 0.25	24 AWG	6.4	17.5	61.0
0028863	10 x 0.25	24 AWG	7.7	25.0	80.0
0028864	14 x 0.25	24 AWG	7.8	35.0	103.0
0028865	18 x 0.25	24 AWG	8.8	45.0	125.0
0028866	25 x 0.25	24 AWG	10.8	62.5	171.0
0028867	2 x 0.34	22 AWG	4.9	6.8	33.0
0028868	3 x 0.34	22 AWG	5.2	10.2	41.0
0028869	4 x 0.34	22 AWG	5.7	13.6	55.0
0028870	5 x 0.34	22 AWG	6.2	17.0	62.0
0028871	7 x 0.34	22 AWG	7.1	23.8	80.0
0028872	10 x 0.34	22 AWG	8.8	34.0	110.0
0028873	14 x 0.34	22 AWG	8.9	47.6	144.0
0028874	18 x 0.34	22 AWG	10.0	61.2	175.0
0028875	25 x 0.34	22 AWG	12.3	85.0	239.0

Copper price basis: EUR 150 / 100 kg

Please find our standard lengths at: www.lappkabel.de/en/cable-standardlengths

Packaging size: Coil ≤ 30 kg and ≤ 250 m, otherwise drum

Please specify the desired packaging size (e.g. 1 x 500 m drum or 5 x 100 m coils)

Accessories

- SILVYN® CHAIN
- SMARTSTRIP stripping tool



Data cables low frequency

Highly flexible and UL/CSA approved

UNITRONIC® FD CP plus UL/CSA



Benefits

- UL/CSA approved, highly flexible data transmission cable with copper braiding and PUR outer sheath for power chain use

Application range

- Automated production processes require data transmission cables of ever more flexibility and durability
- Highly flexible data cable meets the highest service life requirements, even under rough climatic conditions, UL/CSA approved (CMX), ideal for export-oriented machine manufacturer

Product features

- Cable is halogen-free and has low capacitance

- PUR outer sheath, tear resistant and notch ductile, resistant to mineral oils and abrasion when used in power chains
- Adhesion free, resistant to hydrolysis and microbes
- Temperatures up to -40°C possible
- Flame retardant according to IEC 60332-1-2

Approvals (Norm references)



Design

- Stranded bare copper conductor, superfine
- Polyolefine core insulation
- Copper braiding, tinned
- PUR outer sheath
- Colour: grey (RAL 7001)

Technical data

- Core identification code**
DIN 47100, see Appendix T9
- Approvals**
CMX (UL/CSA)
- Mutual capacitance**
C/C approx. 60 nF/km
C/S approx. 160 nF/km
- Peak working voltage**
(not for power applications) 250 V
- Specific insulation resistance**
> 5 GOhm x km
- Inductivity**
approx. 0.65 mH/km
- Conductor stranding**
Strand, superfine wire in accordance with VDE 0295, single wire diameter 0.1 mm
- Conductor resistance**
see Appendix T11
- Minimum bending radius**
For flexible applications:
7.5 x cable diameter
- Test voltage**
1500 V
- Range of temperature**
-40°C up to 75°C

Part number	Number of cores and mm ² per conductor	AWG size	Outer diameter in mm max.	Copper index kg/km	Weight kg/km approx.
UNITRONIC® FD CP plus UL/CSA					
0028880	2 x 0.14	26 AWG	4.5	11.2	33.0
0028881	3 x 0.14	26 AWG	4.7	14.1	36.0
0028882	4 x 0.14	26 AWG	5.1	15.5	40.0
0028883	5 x 0.14	26 AWG	5.4	18.3	45.0
0028884	7 x 0.14	26 AWG	6.0	27.8	67.0
0028885	10 x 0.14	26 AWG	7.0	39.3	87.0
0028886	14 x 0.14	26 AWG	7.1	45.3	102.0
0028887	18 x 0.14	26 AWG	7.7	54.1	118.0
0028888	25 x 0.14	26 AWG	9.2	68.4	157.0
0028889	2 x 0.25	24 AWG	5.1	14.9	38.0
0028890	3 x 0.25	24 AWG	5.4	18.8	45.0
0028891	4 x 0.25	24 AWG	5.8	21.3	52.0
0028892	5 x 0.25	24 AWG	6.2	31.0	69.0
0028893	7 x 0.25	24 AWG	7.0	39.6	84.0
0028894	10 x 0.25	24 AWG	8.5	53.9	109.0
0028895	14 x 0.25	24 AWG	8.6	64.2	136.0
0028896	18 x 0.25	24 AWG	9.4	78.4	161.0
0028897	25 x 0.25	24 AWG	11.4	101.0	213.0
0028898	2 x 0.34	22 AWG	5.6	18.1	45.0
0028899	3 x 0.34	22 AWG	5.9	28.7	61.0
0028900	4 x 0.34	22 AWG	6.3	35.7	77.0
0028901	5 x 0.34	22 AWG	6.8	39.1	83.0
0028902	7 x 0.34	22 AWG	7.7	52.7	109.0
0028903	10 x 0.34	22 AWG	9.4	67.4	147.0
0028904	14 x 0.34	22 AWG	9.5	85.8	186.0
0028905	18 x 0.34	22 AWG	10.7	99.7	216.0
0028906	25 x 0.34	22 AWG	12.9	155.0	314.0

Copper price basis: EUR 150 / 100 kg
 Please find our standard lengths at: www.lappkabel.de/en/cable-standardlengths
 Packaging size: Coil ≤ 30 kg and ≤ 250 m, otherwise drum
 Please specify the desired packaging size (e.g. 1 x 500 m drum or 5 x 100 m coils)

Accessories

- SKINTOP® MS-SC-M see page 114
- SILVYN® CHAIN
- SMARTSTRIP stripping tool

UNITRONIC® FD CP (TP) plus UL/CSA



Benefits

- UL/CSA approved, highly flexible and pair-twisted data transmission cable with copper braiding and PUR outer sheath for power chain use
- Ideal for export-oriented machinery and equipment manufacturers
- Copper braiding protects against interference

Application range

- Power chains
- Linear robots
- Automated handling equipment

Product features

- Decoupling by means of twisted pair (TP) cable design, low capacitance

- Halogen-free
- Cut and abrasion resistant PUR outer sheath
- Adhesion free, resistant to hydrolysis and microbes
- Flame retardant according to IEC 60332-1-2

Approvals (Norm references)



Design

- Stranded bare copper conductor
- Polyolefine core insulation
- Tinned copper braiding
- PUR outer sheath
- Colour: grey (RAL 7001)

Technical data

- Core identification code**
DIN 47100, see Appendix T9
- Approvals**
CMX (UL/CSA)
- Mutual capacitance**
C/C approx. 60 nF/km
C/S approx. 160 nF/km
- Peak working voltage**
(not for power applications) 250 V
- Specific insulation resistance**
> 5 GOhm x km
- Inductivity**
approx. 0.65 mH/km
- Conductor stranding**
Strand, superfine wire Class 6 in accordance with VDE 0295
- Minimum bending radius**
7,5 x outer diameter
- Test voltage**
1500 V
- Loop resistance**
Max. Ohm/km:
0.25 mm² 160;
50 mm² 79;
75 mm² 53;
1.00 mm² 40
- Range of temperature**
Flexing: -40°C up to +75°C

Part number	Number of pairs and mm ² per conductor	AWG size	Outer diameter in mm max.	Copper index kg/km	Weight kg/km approx.
UNITRONIC® FD CP (TP) plus UL/CSA					
0030910	2 x 2 x 0.14	26 AWG	6.2	19.4	42.0
0030911	3 x 2 x 0.14	26 AWG	6.5	23.4	53.0
0030912	4 x 2 x 0.14	26 AWG	6.8	27.1	59.0
0030913	5 x 2 x 0.14	26 AWG	7.3	37.4	75.0
0030914	6 x 2 x 0.14	26 AWG	7.5	49.4	91.0
0030915	8 x 2 x 0.14	26 AWG	8.8	54.8	109.0
0030916	10 x 2 x 0.14	26 AWG	10.0	60.1	120.0
0030962	1 x 2 x 0.25	24 AWG	5.1	14.0	27.0
0030919	2 x 2 x 0.25	24 AWG	7.3	32.0	60.0
0030920	3 x 2 x 0.25	24 AWG	7.7	38.4	72.0
0030921	4 x 2 x 0.25	24 AWG	8.3	43.2	89.0
0030922	5 x 2 x 0.25	24 AWG	8.9	51.5	103.0
0030923	6 x 2 x 0.25	24 AWG	9.2	71.8	131.0
0030924	8 x 2 x 0.25	24 AWG	10.8	74.4	155.0
0030925	10 x 2 x 0.25	24 AWG	12.4	90.0	186.0
0030926	14 x 2 x 0.25	24 AWG	12.6	111.2	219.0
0030963	1 x 2 x 0.34	22 AWG	5.6	20.0	36.0
0030928	2 x 2 x 0.34	22 AWG	8.8	41.0	81.0
0030929	3 x 2 x 0.34	22 AWG	8.7	52.0	101.0
0030930	4 x 2 x 0.34	22 AWG	9.5	59.0	119.0
0030932	6 x 2 x 0.34	22 AWG	11.0	86.2	165.0
0030933	8 x 2 x 0.34	22 AWG	12.2	107.3	221.0
0030934	10 x 2 x 0.34	22 AWG	14.2	131.1	274.0
0030964	1 x 2 x 0.5	20 AWG	6.2	22.0	47.0
0030937	2 x 2 x 0.5	20 AWG	9.3	50.0	99.0
0030938	3 x 2 x 0.5	20 AWG	10.1	71.8	130.0
0030939	4 x 2 x 0.5	20 AWG	10.7	74.4	148.0
0030940	5 x 2 x 0.5	20 AWG	11.8	84.5	168.0
0030941	6 x 2 x 0.5	20 AWG	12.2	99.6	194.0
0030942	8 x 2 x 0.5	20 AWG	14.4	144.3	284.0
0030943	10 x 2 x 0.5	20 AWG	16.4	176.0	343.0
0030944	14 x 2 x 0.5	20 AWG	16.7	215.4	401.0
0030965	1 x 2 x 0.75	19 AWG	6.6	34.0	61.0
0030946	2 x 2 x 0.75	19 AWG	10.2	60.0	112.0
0030947	3 x 2 x 0.75	19 AWG	10.9	85.7	157.0
0030948	4 x 2 x 0.75	19 AWG	11.7	93.6	172.0
0030950	6 x 2 x 0.75	19 AWG	13.2	130.4	231.0
0030951	8 x 2 x 0.75	19 AWG	15.7	192.2	342.0
0030952	10 x 2 x 0.75	19 AWG	17.8	258.0	466.0
0030953	14 x 2 x 0.75	19 AWG	18.7	316.6	545.0
0030955	1 x 2 x 1	18 AWG	7.0	42.0	71.0
0030956	2 x 2 x 1	18 AWG	11.0	73.0	129.0
0030957	3 x 2 x 1	18 AWG	11.9	93.6	169.0
0030958	4 x 2 x 1	18 AWG	12.5	117.8	204.0
0030959	5 x 2 x 1	18 AWG	14.1	139.0	237.0

Copper price basis: EUR 150 / 100 kg
 Please find our standard lengths at: www.lappkabel.de/en/cable-standardlengths
 Packaging size: Coil ≤ 30 kg and ≤ 250 m, otherwise drum
 Please specify the desired packaging size (e.g. 1 x 500 m drum or 5 x 100 m coils)

Accessories

- SILVYN® CHAIN



Data cables low frequency

Cable for sensor / actuator components

UNITRONIC® SENSOR



Application range

- Cables for UNITRONIC® Fieldbus sensor-/actuator wiring requirements
- Data transmission cables to connect to M8, M12 connectors
- Automation technology
- Mechanical engineering
- Plant engineering

Product features

- Core colour in accordance with DIN EN 50044
- 3x 0.34 mm²
1= brown, 2= blue, 3= black
- 4x 0.34 mm²
1= brown, 2= white, 3= blue, 4= black
- 5x 0.25mm² or 0.34mm²
1= brown, 2= white, 3= blue, 4= black, 5=grey
- 8x 0.25mm²
1= white, 2=brown, 3= green, 4= yellow, 5= grey, 6= pink, 7=blue, 8= red

Approvals (Norm references)



Design

- UNITRONIC® SENSOR LiFY
Conductor: Superfine bare copper strand in accordance with DIN VDE 0295 Class 6; Core insulation PCV, Outer sheath PVC vinyl
- UNITRONIC® SENSOR DESINA® LiFY11Y
Stranded bare copper conductor, superfine. In accordance with VDE 0295 Class 6, special PVC insulation, cores twisted in layers, core ident code in accordance with DESINA® (brwon, white, blue, black). Outer sheath of special polyurethane based compound; colour yellow in acc. to RAL 1021; flame retardant acc. to IEC 60332-1-2. Operating voltage= 48 V, Peak working voltage= 300 V.

- UNITRONIC® SENSOR FD UL/CSA - LiFY11Y
Approved AWM UL-style 20549, 80°C / 300 V. Conductor: Cu wire, bare, super-fine strands in accordance with DIN VDE 0295 class 6. Core insulation: modified polypropylene (PP), outer sheath: halogen-free polyurethane (PUR), matt, adhesion free
- UNITRONIC® SENSOR COMBI LiFY11Y 3x0,75+16x0,34
Conductor: Bare copper strand, single wire diameter: 0.10 mm for 0.34 mm², 0.16 mm for 0.75 mm², core insulation: PVC, external sheath: co-extruded double sheath: inner PVC, outer special PUR

Part number	Article designation	Dimension in mm ²	Outer diameter in mm approx.	Core / sheath material	Colour	Copper index kg/km
UNITRONIC® SENSOR						
7038859	S-LiFY **	3x0,34	4.8	PVC/PVC	black	9.8
7038860	S-LiFY **	4x0,34	5.2	PVC/PVC	black	13.1
0040434	DESINA **	4x0,34	5.2	PVC/PVC	yellow RAL 1021	13.5
7038861	S-LiFY11Y **	4x0,34	5.2	PVC/PUR	black	13.1
7038862	S-LiFY11Y **	5x0,25	4.8	PVC/PUR	black	12.0
UNITRONIC® SENSOR FD UL/CSA						
7038864	LiFY11Y **	3x0,34	4.6	PP/PUR	black	9.8
7038865	LiFY11Y **	4x0,34	4.6	PP/PUR	black	13.0
7038866	LiFY11Y **	5x0,34	5.0	PP/PUR	black	16.0
7038867	LiFY11Y **	5x0,25	4.7	PP/PUR	black	12.0
7038868	LiFY11Y **	8x0,25	5.8	PP/PUR	black	19.0

Copper price basis: EUR 150 / 100 kg
 Please find our standard lengths at: www.lappkabel.de/en/cable-standardlengths
 Cables are printed
 Further types on request

Accessories

- S/A M12 connectors that can be assembled
- S/A M8 connectors that can be assembled
- STAR STRIP stripping tool
- SMARTSTRIP stripping tool



Source: PowerWind GmbH

J-Y(ST)Y ...LG Fire Alarm Cable



Info

- Installation cable with the red outer sheath in accordance with VDE 0815

Benefits

- The cable is marked “Fire alarm cable” at regular intervals on the sheath. It is therefore particularly suitable for installation in modern-type fire alarm systems.

Application range

- These installation cables are used for signal transmission in static systems on and under plaster in dry and wet interiors and for outdoor use.

Product features

- The 2-paired versions = star-quad cable design



- Flame retardant according to IEC 60332-1-2

Approvals (Norm references)



Design

- Single wire conductor of plain copper wire
- Core insulation: Based on PVC
- Cores twisted in pairs, pairs twisted together, foil wrapping over cable core, static screen of aluminium-laminated plastic film with copper drain wire
- PVC based outer sheath
- Colour: flame red (RAL 3000)

Technical data

Core identification code
In accordance with VDE 0815, see T 10

Peak working voltage
(not for power applications)
300 V

Based on
VDE 0815

Minimum bending radius
Fixed installation
10 x cable diameter

Test voltage
C/C: 800 V
C/S 800 V

Range of temperature
Fixed installation: -40°C up to +70°C

Use/application
For stationary installation on or under plaster in dry and damp interiors and for outdoors.

Part number	Number of pairs and conductor diameter in mm	Outer diameter in mm approx.	Copper index kg/km	Weight kg/km approx.
J-Y(ST)Y...LG red				
1708001	1 x 2 x 0.8	6.0	11.0	40.0
1708002	2 x 2 x 0.8	7.0	21.0	60.0
1708004	4 x 2 x 0.8	9.0	41.0	100.0
1708006	6 x 2 x 0.8	10.5	62.0	140.0
1708010	10 x 2 x 0.8	13.5	102.0	220.0
1708020	20 x 2 x 0.8	16.5	204.0	380.0

Copper price basis: EUR 100 / 100 kg
Please find our standard lengths at: www.lappkabel.de/en/cable-standardlengths
Packaging size: Coil ≤ 30 kg and ≤ 250 m, otherwise drum



UNITRONIC® BUS CCL



Info

- Lapp Kabel is a regular member of the user organisation CC-Link Partner Association (CLPA), Japan.

Benefits

- The CC-Link® system was developed by Mitsubishi Electric Automation, Japan.
- This CC-Link® bus cable has successfully passed the CC-Link® Conformance Test in Japan.

Product features

- 156 kbit/s 1.200 m
- 625 kbit/s 600 m
- 2,5 Mbit/s 200 m
- 5,0 Mbit/s 110-150 m
- 10,0 Mbit/s 50-100 m

Application range

- CC-Link® (Control & Communication Link) = Field bus network, for both control as well as information data to provide efficient, integrated factory and process automation.
- Stationary installation of the CC-Link® network

Approvals (Norm references)

- LAPP CC-Link® cable is UL/CSA approved (CM or PLTC)



Technical data

	Approvals CM UL/CSA approval 75°C or PLTC Sun Res
	Peak working voltage 300 V rms
	Conductor resistance 11 ohms/1,000 ft. (305 m) at 20°C
	Minimum bending radius 15 x cable diameter
	Test voltage 2000 V
	Range of temperature -40°C to +70°C
	Characteristic impedance 110 ohms at 1 MHz

Part number	Article designation	Number of cores and AWG size	Outer diameter mm	Copper index kg/km	Weight kg/km approx.
2170360	UNITRONIC® BUS CCL UL/CSA (CM/PLTC)	3 x 1 x AWG20	7.7	38.8	76.6

Copper price basis: EUR 150 / 100 kg
 Please find our standard lengths at: www.lappkabel.de/en/cable-standardlengths
 CC-Link® is a registered trademark of CC-Link Partner Association, Japan (CLPA)



UNITRONIC® BUS CAN UL/CSA



Info

- CAN = Controller Area Network



UNITRONIC® BUS FD P CAN UL/CSA



Application range

UNITRONIC® BUS CAN UL/CSA

- Stationary application

UNITRONIC® BUS FD P CAN UL/CSA

- For highly flexible applications.

Product features

- Maximum bit rate: 1 Mbit/s for 40 m segment length
- Larger conductor crosssection necessary with increasing length
See Table below (reference values from ISO 11898).
- For the segment length, cable cross-section and bit rate, ISO 11898 makes recommendations
- Flame retardant according to IEC 60332-1-2

Approvals (Norm references)



- Standardised internationally in ISO 11898

Design

UNITRONIC® BUS CAN UL/CSA

- Stranded 7-wire bare copper conductor
- Colour coded in accordance with DIN 47100
- Copper braid
- PVC outer sheath
- Colour: violet (RAL 4001)

UNITRONIC® BUS FD P CAN UL/CSA

- Stranded bare copper conductor
- Screen braiding made from copper wire
- PUR outer sheath
- Colour: violet (RAL 4001)
- UV-resistant (but colour change after some time possible)

Technical data

Mutual capacitance
UNITRONIC® BUS CAN UL/CSA
 (800 Hz): max. 40 nF/km
UNITRONIC® BUS FD P CAN UL/CSA
 (800 Hz): max. 60 nF/km

Peak working voltage
UNITRONIC® BUS CAN UL/CSA
 (not for power purposes) 250 V
UNITRONIC® BUS FD P CAN UL/CSA
 250 V (not for power applications)

Conductor resistance
UNITRONIC® BUS CAN UL/CSA
 (loop):
 max. 186 Ohm/km
UNITRONIC® BUS FD P CAN UL/CSA
 (loop): max. 159.8 Ohm/km

Minimum bending radius
UNITRONIC® BUS CAN UL/CSA
 Fixed installation: 8 x cable diameter
UNITRONIC® BUS FD P CAN UL/CSA
 Flexing: 15 x cable diameter

Test voltage
 Core/core: 1500 V

Range of temperature
UNITRONIC® BUS CAN UL/CSA
 Fixed installation:
 -40°C up to +75°C
UNITRONIC® BUS FD P CAN UL/CSA
 Occasional flexing: -30°C up to +70°C

Characteristic impedance
 120 ohms

Part number	Article designation	Number of pairs / conductor cross-section in mm²	Outer diameter mm	Copper index kg/km	Weight kg/km approx.
For fixed installation					
2170260	UNITRONIC® BUS CAN UL/CSA (CMX)	1 x 2 x 0,22	5,7	16,7	42,0
2170261	UNITRONIC® BUS CAN UL/CSA (CMX)	2 x 2 x 0,22	7,6	34,8	68,0
2170263	UNITRONIC® BUS CAN UL/CSA (CMX)	1 x 2 x 0,34	6,8	22,1	55,0
2170264	UNITRONIC® BUS CAN UL/CSA (CMX)	2 x 2 x 0,34	8,5	46,4	88,0
2170266	UNITRONIC® BUS CAN UL/CSA (CMX)	1 x 2 x 0,5	7,5	41,6	90,0
2170267	UNITRONIC® BUS CAN UL/CSA (CMX)	2 x 2 x 0,5	9,7	59,4	106,0
2170269	UNITRONIC® BUS CAN UL/CSA (CMX)	1 x 2 x 0,75	8,7	52,7	108,0
2170270	UNITRONIC® BUS CAN UL/CSA (CMX)	2 x 2 x 0,75	11,5	80,6	142,0
For highly flexible application (power chains, frequently moved machine parts)					
2170272	UNITRONIC® BUS FD P CAN UL/CSA (CMX)	1 x 2 x 0,25	6,4	17,5	40,0
2170273	UNITRONIC® BUS FD P CAN UL/CSA (CMX)	2 x 2 x 0,25	8,4	28,0	70,0
2170275	UNITRONIC® BUS FD P CAN UL/CSA (CMX)	1 x 2 x 0,34	6,8	32,8	60,0
2170276	UNITRONIC® BUS FD P CAN UL/CSA (CMX)	2 x 2 x 0,34	9,6	52,4	88,0
2170278	UNITRONIC® BUS FD P CAN UL/CSA (CMX)	1 x 2 x 0,5	8,0	41,9	74,0
2170279	UNITRONIC® BUS FD P CAN UL/CSA (CMX)	2 x 2 x 0,5	10,8	59,4	100,0

Copper price basis: EUR 150 / 100 kg
 Please find our standard lengths at: www.lappkabel.de/en/cable-standardlengths
 Packaging size: Coil ≤ 30 kg and ≤ 250 m, otherwise drum
 Please specify the desired packaging size (e.g. 1 x 500 m drum or 5 x 100 m coils)

Accessories

UNITRONIC® BUS CAN UL/CSA

- Multipurpose shears A and B
- SMARTSTRIP stripping tool

UNITRONIC® BUS FD P CAN UL/CSA

- SILVYN® CHAIN
- Multipurpose shears A and B
- SMARTSTRIP stripping tool



ETHERLINE®

Data communication systems for ETHERNET-Technology

The Lapp Kabel ETHERLINE® range provides the perfect basis for exchanging information using the globally standardised Ethernet protocol. This reduces your cabling work and costs and simultaneously increases the reliability of the data transfer between the top box and the bottom box.

ETHERLINE® includes active network components to supplement your existing cable and connector technologies. A complete data exchange system in a wind turbine also includes security systems such as firewalls, switch systems based on a top hat rail for the harsh ambient conditions in the wind turbine and all of the passive connection components.

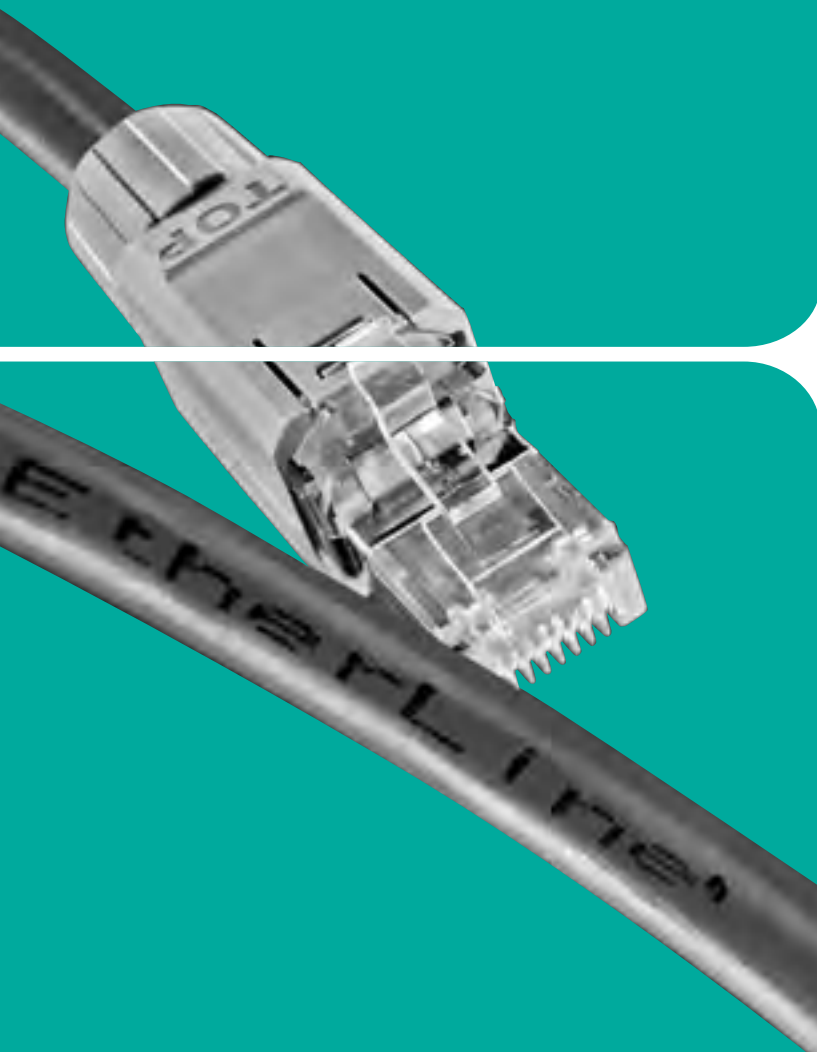

ETHERLINE® TORSION UL (AWM) CAT. 5



Info

- Industrial Ethernet Cable, 2-pair, suitable for torsion stress

Benefits

- This cable is an important supplement to the range of ETHERLINE® Industrial Ethernet cables.
- Cable suitable for torsion stress. Tested with more than 1 million bending cycles and a right / left movement of 180° on 1 meter.

Application range

- Many applications with Industrial Ethernet, e. g. PROFINET, i.e. fixed installation, flexible and highly flexible use as well as TORSION.

Product features

- Flame retardant according to IEC 60332-1-2

- Outer sheath high abrasion resistance

Approvals (Norm references)



- UL AWM (Style 21161)

Design

- Stranded conductor, tinned
- AWG 22 (19-wire)
- PE core insulation
- Star quad
- PUR outer sheath halogen-free

Technical data

- Peak working voltage**
Max. 100 V (not for power applications)
- Minimum bending radius**
Installation: 5 x cable diameter
- Test voltage**
700 V
- Range of temperature**
-40°C up to +80°C
- Characteristic impedance**
At 1 - 100 MHz: 100 +/- 15 Ohm

Part number	Article designation	Number of pairs and AWG size/number of wires per conductor	Outer diameter in mm max.	Copper index kg/km	Weight kg/km approx.
2170888	ETHERLINE® TORSION CAT.5	2 x 2 x AWG22/19	6.5	31.3	52.0

Copper price basis: EUR 150 / 100 kg
 www.lappkabel.de/en/cable-standardlengths
 Packaging size: Coil ≤ 30 kg and ≤ 250 m, otherwise drum
 Please specify the desired packaging size (e.g. 1 x 500 m drum or 5 x 100 m coils)
 PROFINET® is a registered trademark of the PNO (PROFIBUS user organisation)

Accessories

- Multipurpose shears A and B
- SMARTSTRIP stripping tool



Source: PowerWind GmbH



J-H(ST)H ...BD Fire Alarm Cable

Brandmeldekabel J-H(ST)H ... BD BMK



Info

- The halogen-free and flame retardant fire alarm cable in accordance with VDE 0815

Benefits

- Is used to meet enhanced fire protection requirements concerning protection of people as well as high value property
- Does not emit any toxic or corrosive gases in the event of fire and resists the spread of fire

Application range

- This halogen-free, flame retardant installation cable with static screen is used for telephone, data and signal transmission in subscriber stations and private branch exchange construction for telephone systems on dry and wet premises as well as on and under plaster.

Product features

- The resistance to combustion has been tested in accordance with IEC specification 60332-3

Approvals (Norm references)



Design

- Solid bare copper conductor
- Core insulation: Halogen-free
- Four cores twisted as star quad
- Foil wrapping, static screening of aluminium-laminated plastic film with copper drain wire
- Outer sheath of special, halogen-free polymer compound, colour outer sheath red.

Technical data

- Core identification code**
See table T10, according to VDE 0815
- Mutual capacitance**
Max. 120 nF/km
- Peak working voltage**
(not for power applications)
300 V
- Based on**
VDE regulation: VDE 0815
- Insulation resistance**
>100 MOhm x km
- Coupling**
K1: Approx. 300 pF/100 m
K9-12: Approx. 100 pF/100 m
- Minimum bending radius**
In fixed installations:
6 x cable diameter
- Test voltage**
C/C: 800 V
C/S 800 V
- Loop resistance**
Max. 130 Ohm/km
- Range of temperature**
Fixed installation: -30°C up to +70°C

Part number	Number of pairs and conductor diameter in mm	Outer diameter in mm approx.	Copper index kg/km	Weight kg/km approx.
J-H(ST)H...BD				
30017798	2 x 2 x 0,8	9.0	25.0	77.0
30017801	10 x 2 x 0,8	15.0	106.0	250.0

Copper price basis: EUR 100 / 100 kg
 Please find our standard lengths at: www.lappkabel.de/en/cable-standardlengths
 Packaging size: Coil ≤ 30 kg and ≤ 250 m, otherwise drum



Source: PowerWind GmbH

In all EMC-critical areas of a wind turbine, HITRONIC® fibre optic cables provide reliable communication. Even when it comes to very specific requirements, e.g. torsional loads in the drip loop, the globally recognised quality of Lapp fibre optic cable systems offer excellent reliability, inc. UL/CSA in UL and MIL design.

HITRONIC®

Optical transmission systems

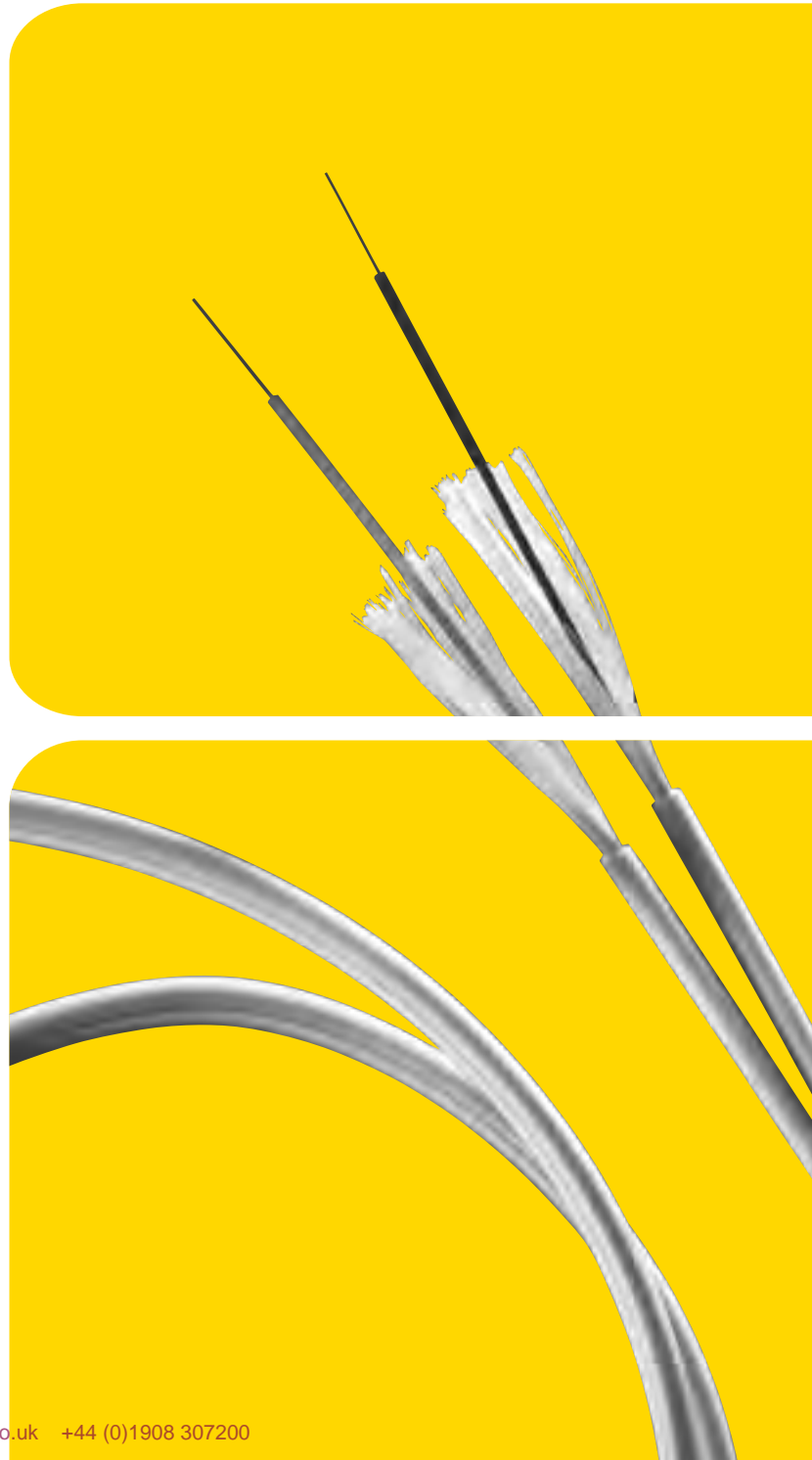

Two different connection types are used with fibre optic cables:

1. Detachable connections realised with plug connectors. In this case it is necessary to attach a plug to a glass fibre. This calls for trained personnel and expensive special tools.
2. Non-detachable connections created by directly splicing two glass fibres together. To do this requires highly trained personnel and very expensive equipment. If the necessary resources are used only occasionally, the investment is very unlikely to pay for itself.

The answer: The Lapp fibre link trunk system.

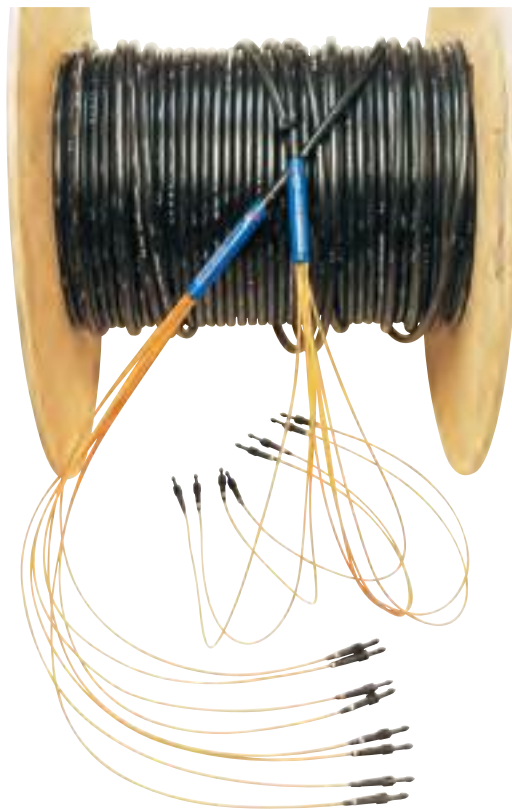

Advantages

Using a trunk system offers you the following advantages:

- No costs of special equipment
- No need for highly trained personnel
- Uniform quality thanks to manufacture under laboratory conditions
- Installation is quick, thereby saving costs
- No need to carry out measurements on the cable run, comes with OTDR test certificate
- Fan-out elements also available in IP67

Requirements

The following data are needed to produce your tailor-made trunk system:

- Length of cable run (effective run +3 to 5 metres reserve on either side)
- Fibre type (SM 9 µm, MM 50 µm or 62.5 µm)
- Number of fibres (2, 4, 6, 8 ... to 48 fibres)
- Plug type (ST, SC, DIN, E-2000 including mixed)
- Cable type (indoor, outdoor, rodent protection etc.)

Duplex Jumper/Patchcord Multimode

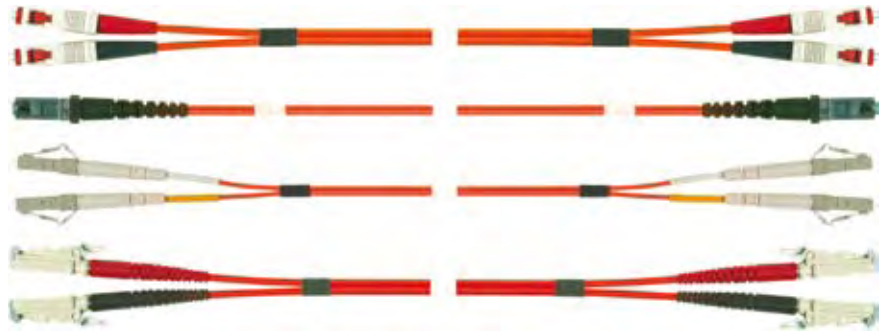

Product features

- Jumper cables are used to make the connection between the workplace PC and the FOC socket. In the data cabinet jumper cables are used to make the connections between the FOC splice box and the active component. Media converters are also connected with

jumper cables. Direct connections between two active components in the in-house area are frequency made with special lengths.

- In our glass fiber assembly we produce individual jumper cables with different plug variations at the customer's request.

Approvals (Norm references)



Part number	Article designation	PU
Duplex Jumper Multimode 50 µm		
93681	Duplex Jumper ST / ST 50 µm, 2.0 m	1 piece
93561	Duplex Jumper SC / SC 50 µm, 2.0 m	1 piece
94641	Duplex Jumper ST / SC 50 µm, 2.0 m	1 piece
9510	Duplex Jumper MTRJ / MTRJ 50 µm, 2.0 m	1 piece
9511	Duplex Jumper MTRJ / SC 50 µm, 2.0 m	1 piece
9513	Duplex Jumper MTRJ / ST 50 µm, 2.0 m	1 piece
9509	Duplex Jumper LC / LC 50 µm, 2.0 m	1 piece
9508	Duplex Jumper LC / SC 50 µm, 2.0 m	1 piece
9501	Duplex Jumper LC / ST 50 µm, 2.0 m	1 piece
9457	Duplex Jumper E2000 / E2000 50 µm, 2.0 m	1 piece
Duplex Jumper Multimode 62.5 µm		
93781	Duplex Jumper ST / ST 62.5 µm, 2.0 m	1 piece
93581	Duplex Jumper SC / SC 62.5 µm, 2.0 m	1 piece
94651	Duplex Jumper ST / SC 62.5 µm, 2.0 m	1 piece
9521	Duplex Jumper MTRJ / SC 62.5 µm, 2.0 m	1 piece
9523	Duplex Jumper MTRJ / ST 62.5 µm, 2.0 m	1 piece
9519	Duplex Jumper LC / LC 62.5 µm, 2.0 m	1 piece
9528	Duplex Jumper LC / SC 62.5 µm, 2.0 m	1 piece
9531	Duplex Jumper LC / ST 62.5 µm, 2.0 m	1 piece

Further lengths and connector types on request.



Duplex Jumper/Patchcord Singlemode



Product features

- Jumper cables are used to make the connection between the workplace PC and the FOC socket. In the data cabinet jumper cables are used to make the connections between the FOC splice box and the active component. Media converters are also connected with

jumper cables. Direct connections between two active components in the in-house area are frequency made with special lengths.

- In our glass fiber assembly we produce individual jumper cables with different plug variations at the customer's request.

Approvals (Norm references)



Part number	Article designation	PU
Duplex Jumper Singlemode 9 µm		
94841	Duplex Jumper ST / ST 9 µm, 2.0 m	1 piece
94891	Duplex Jumper SC / SC 9 µm, 2.0 m	1 piece
94931	Duplex Jumper ST / SC 9 µm, 2.0 m	1 piece
9498	Duplex Jumper E2000-HRL / LC 9 µm, 2.0 m	1 piece
9497	Duplex Jumper E2000-HRL / ST 9 µm, 2.0 m	1 piece
9495	Duplex Jumper E2000-HRL / SC 9 µm, 2.0 m	1 piece
9477	Duplex Jumper E2000-HRL / E2000-HRL 9 µm, 2.0 m	1 piece

Further lengths and connector types on request.

HITRONIC® POF MULTI FIBRE PE-PVC



Info

- POF Multi fibre cable
- With 6 coloured coded fibers

Application range

- Plastic optical fibres for industrial use in the optical signal transmission
- For fixed installation in control cabinets, cable ducts or pipes with simple mechanical stress
- The cable is only for static laying, not free hanging (approx. 10 m connecting between electric control box)

Approvals (Norm references)



Design

- The fibre material is made of polymethylmethacrylate (PMMA)
- The protective cover directly over the step index fibre is made of coloured polyethylene (PE)
- With 6 coloured coded fibers and tear strip
- Colour code fibres: black, white, red, green, grey and orange
- The type of fibres are stranded and with an outer sheath of PVC (black)

Technical data



Dimensions
POF 6 x 980 / 1000 µm

Fibre type
Step index fibre made of polymethylmethacrylate (PMMA)

Optical values
Attenuation at 660 nm wavelength: 220 dB/km

Bandwidth-length product: 120 MHz x 20 m at 650 nm
Numerical aperture: 0.47



Range of temperature
For installation: -5°C up to +50°C
After installation: -30°C up to +70°C



Permissible bending radius
Fixed installation: 7.5 x cable diameter



Permissible tensile force
MULTI FIBRE
400 N
SIMPLEX FIBRE
Temporary: max. 15 N
Fixed installation: max. 5 N

Part number	Article designation	Fibre type	Number of fibres	Outer diameter in mm max.	Weight kg/km approx.
MULTI FIBRE					
3036010	HITRONIC® POF MULTI FIBRE 6 PE-PVC	POF	6	8.8	63.0
SIMPLEX FIBRE					
3035565	HITRONIC® POF SIMPLEX PE black	POF	1	2.2	4.2
3035566	HITRONIC® POF SIMPLEX PE white	POF	1	2.2	4.2
3035567	HITRONIC® POF SIMPLEX PE red	POF	1	2.2	4.2
3035568	HITRONIC® POF SIMPLEX PE green	POF	1	2.2	4.2
3035569	HITRONIC® POF SIMPLEX PE grey	POF	1	2.2	4.2
3035570	HITRONIC® POF SIMPLEX PE orange	POF	1	2.2	4.2

Also versions with more fibres available.

Accessories

- DATA STRIP stripping tool
- Mille-Tie cable ties
- Damage free cable bundles through: Mille-Tie™



HITRONIC® FD Mobile Cable

Benefits

- F.O. Glass Fibre Optical cable for mobile applications outdoor and indoor with nonmetallic Glass yarn strength members
- Very easy to install due to small dimensions, very high flexibility, very small bending radius and suitable for field assembly
- Methods of Deployment: laying in trunking, ducts and trays, building riser, empty plastic pipes, raised floors and plenums for short distances
- Suitable for field assembly
- Designed for despooling and respooling repeatedly

Application range

- Connection cable
- Mini-Breakout cable
- Industrial environment
- High flexibility environment (power chain)

- Premise cabling – backbone

Product features

- Mobile installation cable with up to 8 tight buffered fibres
- Robust and flame retardant PUR outer sheath
- Longitudinal watertight
- Suitable for field assembly
- Very high flexibility

Approvals (Norm references)



Design

- Tight buffered fibres
- Glass yarns with water-blocking tape
- PUR outer sheath

Technical data

Standard designation
AT-VQ(ZN)11Y



Range of temperature
Operation: -30 °C up to +70 °C
Laying: -5°C up to +50°C



Permissible bending radius
15 x cable diameter



Permissible tensile force
800 N, 950 N, 1100 N

Part number	Article designation	Fibre type	Number of fibres	Tension load capacity in N	Outer diameter in mm max.
HITRONIC® FD Multimode G 50					
21807048	HITRONIC® FD800 4G 50/125	50/125	4	800	5.8
21807047	HITRONIC® FD950 6G 50/125	50/125	6	950	6.3
21807051	HITRONIC® FD1100 8G 50/125	50/125	8	1,100	7.0
HITRONIC® FD Multimode G 62.5					
21807045	HITRONIC® FD800 4G 62.5/125	62.5/125	4	800	5.8
21807050	HITRONIC® FD950 6G 62.5/125	62.5/125	6	950	6.3
21807052	HITRONIC® FD1100 8G 62.5/125	62.5/125	8	1,100	7.0

The cables can also be supplied as cut-to-measure LWL trunks. Also with 8 fibers available.

Accessories

- Pigtails
- SILVYN® CHAIN
- SMARTSTRIP stripping tool

HITRONIC® HQN Outdoor Cable



Info

- Outdoor cable with central buffer tube

Benefits

- F.O. Glass Fibre Optical cable for outdoor with nonmetallic Glass yarn strength members
- Easy to install due to compact structure, high flexibility, robust sheath and small bending radius
- Methods of Deployment: empty plastic pipes, ducts and trays

Application range

- For outdoor use
- Campus backbone
- WAN applications
- Industrial environment

Product features

- Central loose tube with up to 24 fibres

- Robust and halogen-free PE outer sheath
- Longitudinal watertight
- Protection against rodent
- High tensile strength

Approvals (Norm references)



Design

- Fibres with primary coating
- Gel-filled loose tube
- Glass yarns with water-blocking tape
- PE outer sheath
- Colour: black (similar to RAL 9005)

Technical data

- Standard designation**
A-DQ(ZN)B2Y
- Range of temperature**
Operation: -20°C up to +60°C
Laying: 0°C up to +50°C
- Permissible bending radius**
Fixed installation: 20 x cable diameter
- Permissible tensile force**
1.000 N to 2.500 N

Part number	Article designation	Fibre type	Number of fibres	Tension load capacity in N	Outer diameter in mm max.
HITRONIC® HQN 1000 Multimode G 50					
2760041	HITRONIC® HQN1000 4G 50/125	50/125	4	1,000	6.5
2760081	HITRONIC® HQN1000 8G 50/125	50/125	8	1,000	6.5
2760121	HITRONIC® HQN1000 12G 50/125	50/125	12	1,000	6.5
2760241	HITRONIC® HQN1000 24G 50/125	50/125	24	1,000	6.8
HITRONIC® HQN 1000 Multimode G 62.5					
2761041	HITRONIC® HQN1000 4G 62.5/125	62,5/125	4	1,000	6.5
2761081	HITRONIC® HQN1000 8G 62.5/125	62,5/125	8	1,000	6.5
2761121	HITRONIC® HQN1000 12G 62.5/125	62,5/125	12	1,000	6.5
2761241	HITRONIC® HQN1000 24G 62.5/125	62,5/125	24	1,000	6.8
HITRONIC® HQN 1000 Singlemode E 9					
2762041	HITRONIC® HQN1000 4E 9/125	9/125	4	1,000	6.5
2762081	HITRONIC® HQN1000 8E 9/125	9/125	8	1,000	6.5
2762121	HITRONIC® HQN1000 12E 9/125	9/125	12	1,000	6.5
2762241	HITRONIC® HQN1000 24E 9/125	9/125	24	1,000	6.8
HITRONIC® HQN 1500 Multimode G 50					
276004	HITRONIC® HQN1500 4G 50/125	50/125	4	1,500	7.5
276008	HITRONIC® HQN1500 8G 50/125	50/125	8	1,500	7.5
276012	HITRONIC® HQN1500 12G 50/125	50/125	12	1,500	7.5
276024	HITRONIC® HQN1500 24G 50/125	50/125	24	1,500	7.8
HITRONIC® HQN 1500 Multimode G 62.5					
276104	HITRONIC® HQN1500 4G 62.5/125	62,5/125	4	1,500	7.5
276108	HITRONIC® HQN1500 8G 62.5/125	62,5/125	8	1,500	7.5
276112	HITRONIC® HQN1500 12G 62.5/125	62,5/125	12	1,500	7.5
276124	HITRONIC® HQN1500 24G 62.5/125	62,5/125	24	1,500	7.8
HITRONIC® HQN 1500 Singlemode E 9					
276208	HITRONIC® HQN1500 8E 9/125	9/125	8	1,500	7.5
276212	HITRONIC® HQN1500 12E 9/125	9/125	12	1,500	7.5
276224	HITRONIC® HQN1500 24E 9/125	9/125	24	1,500	7.8
HITRONIC® HQN2500 Multimode G 50					
276304	HITRONIC® HQN2500 4G 50/125	50/125	4	2,500	9.6
276308	HITRONIC® HQN2500 8G 50/125	50/125	8	2,500	9.6
276312	HITRONIC® HQN2500 12G 50/125	50/125	12	2,500	9.6
276324	HITRONIC® HQN2500 24G 50/125	50/125	24	2,500	9.8
HITRONIC® HQN2500 Multimode G 62.5					
276404	HITRONIC® HQN2500 4G 62.5/125	62,5/125	4	2,500	9.6
276408	HITRONIC® HQN2500 8 G 62.5/125	62,5/125	8	2,500	9.6
276412	HITRONIC® HQN2500 12G 62.5/125	62,5/125	12	2,500	9.6
HITRONIC® HQN2500 Singlemode E 9					
276508	HITRONIC® HQN2500 8E 9/125	9/125	8	2,500	9.6
276512	HITRONIC® HQN2500 12E 9/125	9/125	12	2,500	9.6
276524	HITRONIC® HQN2500 24E 9/125	9/125	24	2,500	9.9

The cables can also be supplied as cut-to-measure LWL trunks. Special multimode fibres (50/125 OM3) for 10 Gigabit Ethernet operation on request.

Accessories

- Pigtaills
- DATA STRIP stripping tool



SKINTOP® SKINDICHT®

Cable glands

High quality cables need high quality cable connections. SKINTOP® ensures a secure fitting in no time at all. Simply insert the cable, close and go. The cable is secured, centred, hermetically sealed and has optimum strain relief. Choose from a variety of designs: Standard PA, with bending protection or as a completely halogen-free version.

All SKINTOP® cable entry systems are DNV approved and thus meet all the requirements for **offshore** use. Further highlights: The innovative, patented brush screening contacts in the EMC series for optimum safety and the new SKINTOP® CLICK series, which has a Lapp Kabel quick locking system and can be installed from one side to save installation time and installation costs.

New to SKINTOP® family are the 75x1.5, 90x2 and 110x2 sizes with innovative double lamella cage for even more safety for users and systems when using large cable cross-sections. Comprehensive accessories round off the SKINTOP® system.



SKINTOP® STR-M / SKINTOP® ST-M

Info

- Now with IP 69 K approval! Proven functionality also during hardest cleaning procedures at industrial machinery with high-pressure cleaners and hot water!

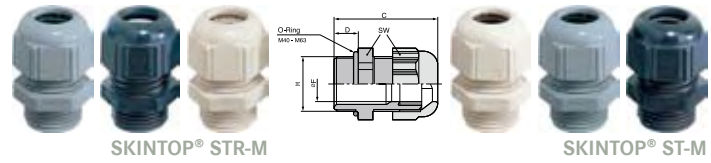

Benefits

SKINTOP® ST-M

- Maximum reliability
- Various accessories (e. g. multiple sealing inserts)
- Permanent vibration protection
- Optimal strain relief
- Large, variable clamping ranges

SKINTOP® STR-M

- Benefits see SKINTOP® ST-M

Application range

SKINTOP® ST-M

- Everywhere where cables must be safely inserted into housings.
- Machine and apparatus construction
- Photovoltaic
- Automation technology
- Mobile off shore units, equipment and ship yards

SKINTOP® STR-M

- With reducing seal insert, to seal cables with smaller outer diameters.

Approvals (Norm references)



Design

- Metric connection thread acc. to EN 50262

Note

SKINTOP® ST-M

- For suitable accessories see SKINTOP® metric accessories
- Counter nut to be used SKINTOP® GMP-GL-M
- SKINTOP® ST M ISO types have a extralong connection thread
- Versions SKINTOP® ST M ISO with extra long connection thread, see table, have no DNV approval

SKINTOP® STR-M

- For suitable accessories see SKINTOP® metric accessories
- Counter nut to be used SKINTOP® GMP-GL-M
- SKINTOP® STR M ISO types have a extralong connection thread
- Versions SKINTOP® STR M ISO with extra long connection thread, see table, have no DNV approval

Suitable cables

SKINTOP® ST-M

- For IP 69 K applications we recommend to use the following cables:
ÖLFLEX® ROBUST 200
ÖLFLEX® AQUA RN8
ÖLFLEX® AQUA BAM

Suitable tools

SKINTOP® ST-M

- SKINMATIC® QUICK Set 1 [P1058]
- SKINMATIC® RZ [P1063]

Technical data

Caution
Installation dimensions and tightening torques see Appendix T21

RAL Colour delivered
RAL 7001 silver-grey
RAL 7035 light grey
RAL 9005 black / UV resistant

Material
Body: Polyamide
Seal: CR

Tests
GGVS: TÜ.EGG.020-95

IP Degree of protection
IP 68 - 5 bar
IP 69 K

Range of temperature
Static: -40°C up to +100°C
Dynamic: -20°C up to +100°C

Part number	Part designation / size	Clamping range ØF mm	SW mm	Overall length C mm	Thread length D mm	Pieces / PU
SKINTOP® ST-M silver grey						
53111000	ST-M 12 x 1,5	3,5-7	15	30,0	8,0	100
53111010	ST-M 16 x 1,5	4,5-10	19	34,0	8,0	100
53111020	ST-M 20 x 1,5	7-13	25	37,0	9,0	100
53111030	ST-M 25 x 1,5	9-17	30	40,0	10,0	50
53111040	ST-M 32 x 1,5	11-21	36	47,0	10,0	25
53111050	ST-M 40 x 1,5	19-28	46	52,0	10,0	10
53111060	ST-M 50 x 1,5	27-35	55	62,0	12,0	5
53111070	ST-M 63 x 1,5	34-45	66	71,0	12,0	5
SKINTOP® ST-M black						
53111200	ST-M 12 x 1,5	3,5-7	15	30,0	8,0	100
53111210	ST-M 16 x 1,5	4,5-10	19	34,0	8,0	100
53111220	ST-M 20 x 1,5	7-13	25	37,0	9,0	100
53111230	ST-M 25 x 1,5	9-17	30	40,0	10,0	50
53111240	ST-M 32 x 1,5	11-21	36	47,0	10,0	25
53111250	ST-M 40 x 1,5	19-28	46	52,0	10,0	10
53111260	ST-M 50 x 1,5	27-35	55	62,0	12,0	5
53111270	ST-M 63 x 1,5	34-45	66	71,0	12,0	5
SKINTOP® ST-M light grey						
53111400	ST-M 12 x 1,5	3,5-7	15	30,0	8,0	100
53111410	ST-M 16 x 1,5	4,5-10	19	34,0	8,0	100
53111420	ST-M 20 x 1,5	7-13	25	37,0	9,0	100
53111430	ST-M 25 x 1,5	9-17	30	40,0	10,0	50
53111440	ST-M 32 x 1,5	11-21	36	47,0	10,0	25
53111450	ST-M 40 x 1,5	19-28	46	52,0	10,0	10
53111460	ST-M 50 x 1,5	27-35	55	62,0	12,0	5
53111470	ST-M 63 x 1,5	34-45	66	71,0	12,0	5
SKINTOP® ST M ISO silver-grey (with long metric connecting thread)						
53017010	ST M 16 x 1,5	3,5-8	19	40,0	12,0	100
53017030	ST M 20 x 1,5	5-12	24	45,0	13,0	100
53017040	ST M 25 x 1,5	9-14	27	47,0	13,0	50
SKINTOP® ST M ISO black (with long metric connecting thread)						
53017210	ST M 16 x 1,5	3,5-8	19	40,0	12,0	100
53017230	ST M 20 x 1,5	5-12	24	45,0	13,0	100
53017240	ST M 25 x 1,5	9-14	27	47,0	13,0	50
SKINTOP® STR-M silver grey						
53111100	STR-M 12 x 1,5	1-5	15	30,0	8,0	100
53111110	STR-M 16 x 1,5	2-7	19	34,0	8,0	100
53111120	STR-M 20 x 1,5	5-10	25	37,0	9,0	100



Part number	Part designation / size	Clamping range ØF mm	SW mm	Overall length C mm	Thread length D mm	Pieces / PU
53111130	STR-M 25 x 1,5	6-13	30	40,0	10,0	50
53111140	STR-M 32 x 1,5	7-15	36	47,0	10,0	25
53111150	STR-M 40 x 1,5	15-23	46	52,0	10,0	10
53111160	STR-M 50 x 1,5	22-29	55	62,0	12,0	5
53111170	STR-M 63 x 1,5	28-39	66	71,0	12,0	5
SKINTOP® STR-M black						
53111300	STR-M 12 x 1,5	1-5	15	30,0	8,0	100
53111310	STR-M 16 x 1,5	2-7	19	34,0	8,0	100
53111320	STR-M 20 x 1,5	5-10	25	37,0	9,0	100
53111330	STR-M 25 x 1,5	6-13	30	40,0	10,0	50
53111340	STR-M 32 x 1,5	7-15	36	47,0	10,0	25
53111350	STR-M 40 x 1,5	15-23	46	52,0	10,0	10
53111360	STR-M 50 x 1,5	22-29	55	62,0	12,0	5
53111370	STR-M 63 x 1,5	28-39	66	71,0	12,0	5
SKINTOP® STR-M light grey						
53111500	STR-M 12 x 1,5	1-5	15	30,0	8,0	100
53111510	STR-M 16 x 1,5	2-7	19	34,0	8,0	100
53111520	STR-M 20 x 1,5	5-10	25	37,0	9,0	100
53111530	STR-M 25 x 1,5	6-13	30	40,0	10,0	50
53111540	STR-M 32 x 1,5	7-15	36	47,0	10,0	25
53111550	STR-M 40 x 1,5	15-23	46	52,0	10,0	10
53111560	STR-M 50 x 1,5	22-29	55	62,0	12,0	5
53111570	STR-M 63 x 1,5	28-39	66	71,0	12,0	5
SKINTOP® STR M ISO silver-grey (with long metric connecting thread)						
53017110	STR M 16 x 1,5	2-6	19	40,0	12,0	100
53017130	STR M 20 x 1,5	4-9	24	45,0	13,0	100
53017140	STR M 25 x 1,5	6-12	27	47,0	13,0	50
SKINTOP® STR M ISO black (with long metric connecting thread)						
53017310	STR M 16 x 1,5	2-6	19	40,0	12,0	100
53017330	STR M 20 x 1,5	4-9	24	45,0	13,0	100
53017340	STR M 25 x 1,5	6-12	27	47,0	13,0	50

■ Accessories

SKINTOP® ST-M

- SKINTOP® DIX-M see page 117
- SKINTOP® GMP-GL-M see page 116
- SKINTOP® DIX-M AUTOMATION see page 118
- SKINTOP® SDV-M ATEX
- SKINTOP® SD-M
- SKINTOP® DV-M

SKINTOP® STR-M

- SKINTOP® GMP-GL-M see page 116
- SKINTOP® SDVR-M ATEX
- SKINTOP® SD-M



Source: PowerWind GmbH



New

SKINTOP® CLICK-R / SKINTOP® CLICK



Info

• The most innovative cable insertion system on the market for very fast, highly flexible assembly. Simply click in - turn to left - turn to right - finished. Result: fixed, centred, strain relieved and maximum protection class in seconds.



Benefits

SKINTOP® CLICK

- Fewer parts, counter nut no longer needed
- Up to 70% time saving due to innovative CLICK system
- Simple, free assembly in any position
- Vibration protection
- No thread required

SKINTOP® CLICK-R

- Benefits see SKINTOP® CLICK

Application range

SKINTOP® CLICK

- Automation technology
- Solar applications

- Switch cabinet building
 - Measurement, control and electrical applications
 - Air conditioning technology
- SKINTOP® CLICK-R**
- With reducing seal insert, to seal cables with smaller outer diameters.

Approvals (Norm references)



Scope of delivery

- Disassembly tool contained in the delivery scope

Technical data

- RAL** Colour delivered
 RAL 7001 silver-grey
 RAL 7035 light grey
 RAL 9005 black / UV resistant
- Material**
 Body: special polyamide
 Seal: special elastomer
- IP** Degree of protection
SKINTOP® CLICK
 IP 68 - 5 bar (M12 bis M25)
 IP 68 - 4 bar (M32)
- Range of temperature**
 -20°C up to +100°C

Part number	Part designation / size	Clamping range ØF mm	M (hole mm)	SW1 / SW2 mm	Overall length C mm	Thread length D mm	S (wall thickness mm)	Pieces / PU
SKINTOP® CLICK light grey								
53112692	CLICK 12	3.5 - 7	12,3 (-0,2)	15 / 18	40,0	8,0	1,0 - 4,0	50
53112686	CLICK 16	5 - 9	16,3 (-0,2)	19 / 22	42,0	8,0	1,0 - 4,0	50
53112687	CLICK 20	7 - 13	20,3 (-0,2)	25 / 27	45,5	8,0	1,0 - 4,0	25
53112688	CLICK 25	9 - 17	25,3 (-0,2)	30 / 34	48,5	8,0	1,0 - 4,0	25
53112694	CLICK 32	11 - 21	32,3 (-0,2)	36 / 40	55,0	8,0	1,0 - 4,0	25
SKINTOP® CLICK silver grey								
53112921	CLICK 12	3.5 - 7	12,3 (-0,2)	15 / 18	40,0	8,0	1,0 - 4,0	50
53112876	CLICK 16	5 - 9	16,3 (-0,2)	19 / 22	42,0	8,0	1,0 - 4,0	50
53112877	CLICK 20	7 - 13	20,3 (-0,2)	25 / 27	45,5	8,0	1,0 - 4,0	25
53112878	CLICK 25	9 - 17	25,3 (-0,2)	30 / 34	48,5	8,0	1,0 - 4,0	25
53112922	CLICK 32	11 - 21	32,3 (-0,2)	36 / 40	55,0	8,0	1,0 - 4,0	25
SKINTOP® CLICK black								
53112923	CLICK 12	3.5 - 7	12,3 (-0,2)	15 / 18	40,0	8,0	1,0 - 4,0	50
53112882	CLICK 16	5 - 9	16,3 (-0,2)	19 / 22	42,0	8,0	1,0 - 4,0	50
53112883	CLICK 20	7 - 13	20,3 (-0,2)	25 / 27	45,5	8,0	1,0 - 4,0	25
53112884	CLICK 25	9 - 17	25,3 (-0,2)	30 / 34	48,5	8,0	1,0 - 4,0	25
53112924	CLICK 32	11 - 21	32,3 (-0,2)	36 / 40	55,0	8,0	1,0 - 4,0	25
SKINTOP® CLICK-R light grey								
53112925	CLICK-R 12	1 - 5	12,3 (-0,2)	15 / 18	40,0	8,0	1,0 - 4,0	50
53112689	CLICK-R 16	4 - 7	16,3 (-0,2)	19 / 22	42,0	8,0	1,0 - 4,0	50
53112690	CLICK-R 20	5 - 10	20,3 (-0,2)	25 / 27	45,5	8,0	1,0 - 4,0	25
53112691	CLICK-R 25	6 - 13	25,3 (-0,2)	30 / 34	48,5	8,0	1,0 - 4,0	25
53112926	CLICK-R 32	7 - 15	32,3 (-0,2)	36 / 40	55,0	8,0	1,0 - 4,0	25
SKINTOP® CLICK-R silver grey								
53112927	CLICK-R 12	1 - 5	12,3 (-0,2)	15 / 18	40,0	8,0	1,0 - 4,0	50
53112879	CLICK-R 16	4 - 7	16,3 (-0,2)	19 / 22	42,0	8,0	1,0 - 4,0	50
53112880	CLICK-R 20	5 - 10	20,3 (-0,2)	25 / 27	45,5	8,0	1,0 - 4,0	25
53112881	CLICK-R 25	6 - 13	25,3 (-0,2)	30 / 34	48,5	8,0	1,0 - 4,0	25
53112928	CLICK-R 32	7 - 15	32,3 (-0,2)	36 / 40	55,0	8,0	1,0 - 4,0	25
SKINTOP® CLICK-R black								
53112929	CLICK-R 12	1 - 5	12,3 (-0,2)	15 / 18	40,0	8,0	1,0 - 4,0	50
53112885	CLICK-R 16	4 - 7	16,3 (-0,2)	19 / 22	42,0	8,0	1,0 - 4,0	50
53112886	CLICK-R 20	5 - 10	20,3 (-0,2)	25 / 27	45,5	8,0	1,0 - 4,0	25
53112887	CLICK-R 25	6 - 13	25,3 (-0,2)	30 / 34	48,5	8,0	1,0 - 4,0	25
53112931	CLICK-R 32	7 - 15	32,3 (-0,2)	36 / 40	55,0	8,0	1,0 - 4,0	25

Accessories

SKINTOP® CLICK

- SKINTOP® DIX-M see page 117
- SKINTOP® DIX-M AUTOMATION see page 118
- SKINTOP® SDV-M ATEX
- SKINTOP® SD-M
- SKINTOP® DV-M

SKINTOP® CLICK-R

- SKINTOP® SDVR-M ATEX



SKINTOP® ST-HF-M

SKINTOP® halogen-free

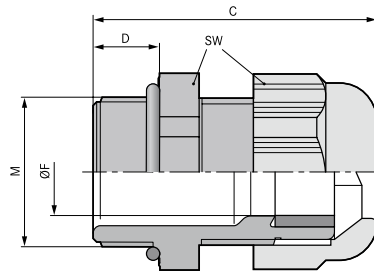

SKINTOP® ST-HF-M

Benefits

- Maximum reliability
- Extremely flame retardant according to UL 94 V0
- Completely halogen-free (inclusive seal material)
- Self extinguishing, no dripping
- Permanent vibration protection

Application range

- Where personal and property protection is a priority.

- Public buildings
- Ventilation systems
- Tunnel construction
- Underground railways and trains

Approvals (Norm references)



Design

- Metric connection thread acc. to EN 50262

Technical data

- Caution**
Installation dimensions and tightening torques see Appendix T21
- Approvals**
DIN VDE VDE / EN 50262
Filament wire test
EN 60695-2-1/1
+960°C
- Colour delivered**
RAL 7035 light grey
- Material**
Polyamide UL94 V0 - halogen-free
Seal: LSE 1 - halogen-free
O-ring: LSE 1 - halogen-free
- Degree of protection**
IP 68 - 5 bar
- Range of temperature**
-20°C up to +100°C

Part number	Part designation / size	Clamping range ØF mm	SW mm	Overall length C mm	Thread length D mm	Pieces / PU
SKINTOP® ST-HF-M						
53111407	ST-HF-M 12 x 1,5	4-5,5	15	30,0	8,0	100
53111417	ST-HF-M 16 x 1,5	4,5-9	19	34,0	8,0	100
53111427	ST-HF-M 20 x 1,5	7-13	25	37,0	9,0	100
53111437	ST-HF-M 25 x 1,5	9-17	30	40,0	10,0	50
53111447	ST-HF-M 32 x 1,5	11-21	36	47,0	10,0	25

Accessories

- SKINTOP® GMP-HF-M see page 110

SKINTOP® GMP-HF-M

SKINTOP® counter nuts



Technical data

- Note**
Dimension sheet available on request
- Colour delivered**
RAL 7035 light grey
- Material**
Polyamide UL94 V0 - halogen-free
- Range of temperature**
-20°C up to +100°C

Benefits

- Halogen-free
- Extremely flame retardant according to UL 94 V0
- Self extinguishing, no dripping

Application range

- For locking of SKINTOP® cable glands in boreholes without thread.
- Airports
- Tunnel construction
- Underground railways
- Public buildings

Approvals (Norm references)



Design

- Metric connection thread acc. to EN 50262

Note

- Designed for use with SKINTOP® ST-HF-M

Part number	Part designation / size	SW mm	PU
SKINTOP® GMP-HF-M			
53119200	12 x 1,5	17	100
53119210	16 x 1,5	22	100
53119220	20 x 1,5	27	100
53119230	25 x 1,5	34	100
53119240	32 x 1,5	41	100

Accessories

- SKINTOP® ST-HF-M see page 110

SKINTOP® BS-M

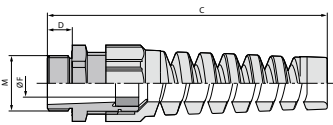

SKINTOP® BS-M

Benefits

- Reliable bending and antikink protection
- Conservation
- Functional reliability
- To protect flexible cables

Application range

- Cables for electrical appliances and machinery, which are moved under normal use, must be protected against excessive bending, as required in accordance with VDE 0730.
- Hand-held equipment
- Robotics industry
- Light and sound applications
- Flexing machine parts

Approvals (Norm references)



Design

- Metric connection thread acc. to EN 50262

Note

- For suitable accessories see SKINTOP® metric accessories
- Counter nut to be used SKINTOP® GMP-GL-M
- Version with reducing insert to seal smaller cable cross-sections SKINTOP® BSR-M on request
- Versions SKINTOP® BS M ISO with extra long connection thread, see table, have no DNV approval

Technical data

Caution
Installation dimensions and tightening torques see Appendix T21

On request
With reducing sealing ring

Colour delivered
RAL 7001 silver-grey
RAL 7035 light grey
RAL 9005 black / UV resistant

Material
Body: Polyamide
Seal: CR

Degree of protection
IP 68 - 5 bar

Range of temperature
-20°C up to +100°C

Part number	Part designation / size	Clamping range ØF mm	SW mm	Overall length C mm	Thread length D mm	Pieces / PU
SKINTOP® BS-M silver grey						
53111600	BS-M 12x1,5	3,5-7	15	64,0	8,0	100
53111610	BS-M 16x1,5	4,5-10	19	86,0	8,0	100
53111620	BS-M 20x1,5	7-13	25	101,0	8,0	50
53111630	BS-M 25x1,5	9-17	30	125,0	9,0	25
53111640	BS-M 32x1,5	11-21	36	149,0	10,0	25
SKINTOP® BS-M black						
53111700	BS-M 12x1,5	3,5-7	15	64,0	8,0	100
53111710	BS-M 16x1,5	4,5-10	19	86,0	8,0	100
53111720	BS-M 20x1,5	7-13	25	101,0	8,0	50
53111730	BS-M 25x1,5	9-17	30	125,0	9,0	25
53111740	BS-M 32x1,5	11-21	36	149,0	10,0	25
SKINTOP® BS-M light grey						
53111800	BS-M 12x1,5	3,5-7	15	64,0	8,0	100
53111810	BS-M 16x1,5	4,5-10	19	86,0	8,0	100
53111820	BS-M 20x1,5	7-13	25	101,0	8,0	50
53111830	BS-M 25x1,5	9-17	30	125,0	9,0	25
53111840	BS-M 32x1,5	11-21	36	149,0	10,0	25
SKINTOP® BS M ISO silver-grey (with long metric connecting thread)						
53017610	BS M16 x 1,5 PG 9	3,5-8	19	77,5	12,0	100
53017630	BS M 20 x 1,5 PG 13,5	5-12	24	102,0	13,0	50
53017640	BS M 25 x 1,5 PG 16	9-14	27	114,5	13,0	50
SKINTOP® BS M ISO black (with long metric connecting thread)						
53017810	BS M 16 x 1,5 PG 9	3,5-8	19	77,5	12,0	100
53017830	BS M 20 x 1,5 PG 13,5	5-12	24	102,0	13,0	50
53017840	BS M 25 x 1,5 PG 16	9-14	27	114,5	13,0	50



Source: PowerWind GmbH



SKINTOP® BT-M

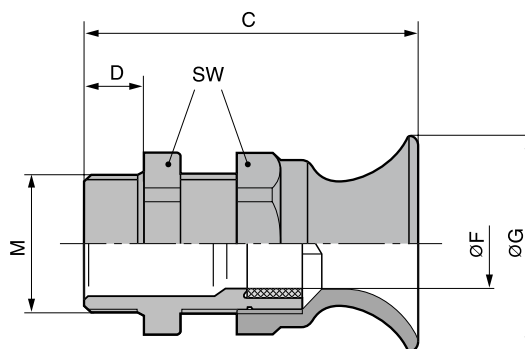

SKINTOP® BT-M

Benefits

- Reliable bending and antikink protection
- Conservation
- Functional reliability
- To protect flexible cables

Application range

- Cables for electrical appliances and machinery, which are moved under normal use, must be protected against excessive bending, as required in accordance with VDE 0730.
- Hand-held equipment
- Apparatus construction
- Light and sound applications

- Flexing machine parts

Approvals (Norm references)



Design

- Metric connection thread acc. to EN 50262

Note

- For suitable accessories see SKINTOP® accessories PG
- Counter nut to be used SKINTOP® GMP-GL-M

Technical data

Caution
Installation dimensions and tightening torques see Appendix T21

Colour delivered
RAL 7001 silver grey

Material
Body: Polyamide
Seal: CR

Degree of protection
IP 68 - 5 bar

Range of temperature
-20°C up to +100°C

Part number	Part designation / size	Clamping range ØF mm	SW mm	Overall length C mm	Thread length D mm	Pieces / PU
SKINTOP® BT-M						
53017420	16 x 1,5	3,5-8	19	45,0	12,0	100
53017430	20 x 1,5	5-12	24	54,0	13,0	50
53017440	25 x 1,5	9-14	27	57,0	13,0	50



Source: PowerWind GmbH

New

SKINTOP® MSR-M / SKINTOP® MS-M

Info

- Sizes SKINTOP® MS-M 75x1,5 to 110x2 with innovative double lamella gasket for easier assembling of cables with large diameters.
- Now with IP 69 K approval! Proven functionality also during hardest cleaning procedures at industrial machinery with high-pressure cleaners and hot water!

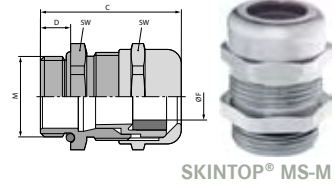
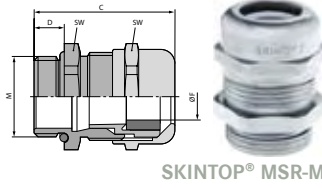

Benefits

SKINTOP® MS-M

- Maximum reliability
- Optimal strain relief
- Large, variable clamping ranges
- For cable diameters up to 98 mm

SKINTOP® MSR-M

- Benefits see SKINTOP® MS-M

Application range

SKINTOP® MS-M

- In areas with high demands on special mechanical and chemical stability.
- Chemical industry
- Measurement and control technology
- Machine and apparatus construction
- Plant engineering

SKINTOP® MSR-M

- With reducing seal insert, to seal cables with smaller outer diameters.

Approvals (Norm references)



Design

- Metric connection thread acc. to EN 50262

Note

- Counter nut to be used SKINDICHT® SM-M
- For suitable accessories see SKINTOP® metric accessories

Suitable cables

SKINTOP® MS-M

- For IP 69 K applications we recommend to use the following cables:
 ÖLFLEX® ROBUST 200
 ÖLFLEX® AQUA RN8
 ÖLFLEX® AQUA BAM

Technical data

Caution
Installation dimensions and tightening torques see Appendix T21

Approvals
UL, CSA, DNV, IP 69 K approval for size M75x1,5 pending
UL, CSA, DNV, VDE, IP 69 K approval for size M90x2 to M110x2 pending

Material
Body: Nickel plated brass
Insert: Polyamide
Seal: CR
O-ring: NBR

Degree of protection
IP 68
IP 69 K

Range of temperature
-30°C up to +100°C

Part number	Part designation / size	Clamping range ØF mm	SW mm	Overall length C mm	Thread length D mm	Pieces / PU
SKINTOP® MS-M						
53112000	12 x 1,5	3-7	16	26.5	6.5	100
53112010	16 x 1,5	4,5-10	20	32.0	7.0	100
53112020	20 x 1,5	7-13	24	35.5	8.0	50
53112030	25 x 1,5	9-17	29	37.5	8.0	25
53112040	32 x 1,5	11-21	36	42.2	9.0	25
53112050	40 x 1,5	19-28	45	49.5	9.0	10
53112060	50 x 1,5	27-35	54	52.0	10.0	5
53112070	63 x 1,5	34-45	67	61.3	15.0	5
53112080	63 x 1,5 plus	44-55	75	65.5	15.0	5
53112510	75 x 1,5	58-68	95	105.0	15.0	1
53112512	90 x 2	66-78	115	136.0	20.0	1
53112514	110 x 2	86-98	135	154.0	25.0	1
SKINTOP® MSR-M						
53112100	12 x 1,5	1-5	16	26.5	6.5	100
53112110	16 x 1,5	2-7	20	32.0	7.0	100
53112120	20 x 1,5	5-10	24	35.5	8.0	50
53112130	25 x 1,5	6-13	29	37.5	8.0	25
53112140	32 x 1,5	7-15	36	42.2	9.0	25
53112150	40 x 1,5	15-23	45	49.5	9.0	10
53112160	50 x 1,5	22-29	54	52.0	10.0	5
53112170	63 x 1,5	28-39	67	61.3	15.0	5
53112511	75 x 1,5	53-63	95	105.0	15.0	1
53112515	110 x 2	76-88	135	154.0	25.0	1

Accessories

SKINTOP® MS-M

- SKINDICHT® SM-M see page 121
- SKINTOP® DIX-M see page 117
- SKINTOP® DIX-M AUTOMATION see page 118
- SKINTOP® SDV-M ATEX
- SKINTOP® SD-M
- SKINTOP® DV-M

SKINTOP® MSR-M

- SKINDICHT® SM-M see page 121
- SKINTOP® SDVR-M ATEX
- SKINTOP® SD-M



SKINTOP® cable glands nickel plated brass metric
SKINTOP® EMC/Earthing

SKINTOP® MS-SC-M



SKINTOP® MS-SC-M

■ **Benefits**

- Suitable for cables and wires with and without inner sheath
- Also suitable for continuing the cable screen to another connection
- Low resistance screen contact, optimal EMC protection
- High conductive, flexible EMC contact for clamping of various screen diameters
- Few operation steps, easy to assemble

■ **Application range**

- For EMC compliant earthing of the copper braiding and copper shaft sheath.
- Automation technology
- Tele communication
- Measurement and control technology
- Plant engineering

■ **Approvals (Norm references)**



■ **Design**

- Metric connection thread acc. to EN 50262

■ **Note**

- For painted, anodised or powdered-coated housings, you will require our EMC counter nut SKINDICHT® SM-PE-M for best contact
- For suitable accessories see SKINTOP® metric accessories
- As a variant for thick wall housings we recommend SKINTOP® MS-SC-M-XL with long connection thread in the sizes M16 to M50

■ **Technical data**

- Caution**
Installation dimensions and tightening torques see Appendix T21
- Material**
Body: Nickel plated brass
Insert: Polyamide
Seal: CR
O-ring: NBR
- Degree of protection**
IP 68 - 5 bar
- Range of temperature**
-30°C up to +100°C

Part number	Part designation / size	Outer-Ø mm from - to	Minimum Ø above braiding in mm	SW mm	Thread length D mm	Pieces / PU
SKINTOP® MS-SC-M						
53112610	12 x 1,5	3,5-7,0	2,0	16	6,5	50
53112620	16 x 1,5	4,5-9,0	4,0	20	7,0	50
53112630	20 x 1,5	7,0-12,5	5,0	24	8,0	25
53112640	25 x 1,5	9,0-16,5	7,5	29	8,0	25
53112650	32 x 1,5	11,0-21,0	9,0	36	9,0	25
53112660	40 x 1,5	19,0-28,0	15,0	45	9,0	10
53112670	50 x 1,5	27,0-35,0	21,0	54	10,0	5
SKINTOP® MS-SC-M-XL						
53112625	16 x 1,5	4,5-9,0	4,0	20	12,0	50
53112635	20 x 1,5	7,0-12,5	5,0	24	12,0	25
53112645	25 x 1,5	9,0-16,5	7,5	29	12,0	25
53112655	32 x 1,5	11,0-21,0	9,0	36	15,0	25
53112665	40 x 1,5	19,0-28,0	15,0	45	15,0	10
53112675	50 x 1,5	27,0-35,0	21,0	54	15,0	5

■ **Accessories**

- SKINDICHT® SM-PE-M see page 121

New

SKINTOP® MS-SC-M BRUSH

Benefits

- Faster, easier screen contact
- Optimal low-resistance 360° screen contact
- Faster than any other comparable system
- Uncomplicated and reliable
- Maximum assembly and adjustment possibility

Application range

- For EMC compliant earthing of the copper braiding and copper shaft sheath.
- Automotive systems
- Conveyor technology
- High power drives
- Frequency converters

Approvals (Norm references)



Design

- Metric connection thread acc. to EN 50262

Note

- For painted, anodised or powdered-coated housings, you will require our EMC counter nut SKINDICHT® SM-PE-M for best contact



Info

- **Sizes SKINTOP® MS-SC-M BRUSH 75x1,5 to 110x2 with innovative double lamella gasket for easier assembling of cables with large diameters.**

Technical data



Caution

Installation dimensions and tightening torques see Appendix T21



Approvals

VDE approval for sizes M90x2 to 110x2 pending



Material

Body: nickel plated brass
Insert: polyamide
Seal: special elastomer
O-ring: special elastomer



Degree of protection

IP 68



Range of temperature

Dynamic: -30°C up to +100°C



Part number	Part designation / size	Outer-Ø mm from - to	Minimum Ø above braiding in mm	SW mm	Thread length D mm	Pieces / PU
SKINTOP® MS-SC-M BRUSH						
53112676	25 x 1,5	9.0-17.0	6.0	29	8.0	10
53112677	32 x 1,5	11.0-21.0	2.0	36	9.0	1
53112678	40 x 1,5	19.0-28.0	15.0	45	9.0	1
53112679	50 x 1,5	27.0-35.0	20.0	54	10.0	1
53112680	63 x 1,5	34.0-45.0	25.0	67	15.0	1
53112681	63 x 1,5 plus	44.0-55.0	30.0	75	15.0	1
53112501	75 x 1,5	53.0-63.0	40.0	95	15.0	1
53112500	75 x 1,5 plus	58.0-68.0	40.0	95	15.0	1
53112503	90 x 2	66.0-78.0	45.0	115	20.0	1
53112505	110 x 2	76.0-88.0	55.0	135	25.0	1
53112504	110 x 2 plus	86.0-98.0	55.0	135	25.0	1

Accessories

- SKINDICHT® SM-PE-M see page 121



SKINTOP® GMP-GL-M



SKINTOP® GMP-GL-M

■ **Benefits**

- Glas fibre reinforced for maximum mechanical stability
- Bearing surface avoids scratchings on the housing while mounting with an wrench

■ **Application range**

- For locking of SKINTOP® cable glands in boreholes without thread.

■ **Approvals (Norm references)**



■ **Design**

- Metric connection thread acc. to EN 50262

■ **Note**

- UL approval only when used with the UL approved SKINTOP® polyamide cable glands
- Designed for use in connection with metric SKINTOP® cable glands

■ **Technical data**

- i** **On request**
Available without collar (without surface for assembling tool)
- RAL** **Colour delivered**
RAL 7001 silver-grey
RAL 7035 light grey
RAL 9005 black / UV resistant
- Material**
Polyamide, glass fibre reinforced
- Range of temperature**
Static: -40°C up to +100°C
Dynamic: -20°C up to +100°C

Part number	Part designation / size	SW mm	Pieces / PU
SKINTOP® GMP-GL-M silver grey			
53119000	12 x 1,5	17	100
53119010	16 x 1,5	22	100
53119020	20 x 1,5	27	100
53119030	25 x 1,5	34	100
53119040	32 x 1,5	41	100
53119050	40 x 1,5	50	25
53119060	50 x 1,5	60	25
53119070	63 x 1,5	75	25
SKINTOP® GMP-GL-M black			
53119100	12 x 1,5	17	100
53119110	16 x 1,5	22	100
53119120	20 x 1,5	27	100
53119130	25 x 1,5	34	100
53119140	32 x 1,5	41	100
53119150	40 x 1,5	50	25
53119160	50 x 1,5	60	25
53119170	63 x 1,5	75	25
SKINTOP® GMP-GL-M light grey			
53119003	12 x 1,5	17	100
53119013	16 x 1,5	22	100
53119023	20 x 1,5	27	100
53119033	25 x 1,5	34	100
53119043	32 x 1,5	41	100
53119053	40 x 1,5	50	25
53119063	50 x 1,5	60	25
53119073	63 x 1,5	75	25

SKINTOP® DIX-M

Benefits

- For inserting different cables or wires into only one gland
- Higher packing density allows smaller part construction

Application range

- To be used in SKINTOP® cable glands.
- Sealing ring with several holes is used in place of the inner sealing insert.

Approvals (Norm references)



Note

- IP 68 can be achieved when all openings are closed and all bores are optimally occupied, i.e. when using cables with nominal diameter and/or SKINTOP® DIX-DV

Design

- SKINTOP® DIX-M VITON® is resistant to oil, water, alkaline solutions, acids, solvents,...

Technical data

- i** On request
Special shapes
- RAL** Colour delivered
RAL 9005 black
- Material**
NBR
VITON®
- IP** Degree of protection
IP 54
- 0-100°C** Range of temperature
-40°C up to +100°C



Part number	Part designation / size	Size M	Number of cables x Cable Ø	Pieces / PU
SKINTOP® DIX-M				
53316220	16,220	M 16	2 x 2.0	100
53316230	16,230	M 16	2 x 3.0	100
53316240	16,240	M 16	2 x 4.0	100
53320250	20,250	M 20	2 x 5.0	100
53320260	20,260	M 20	2 x 6.0	100
53320340	20,340	M 20	3 x 4.0	100
53320353	20,353	M 20	3 x 5.3	100
53310440	20,358	M 20	3 x 5.8	100
53320440	20,440	M 20	4 x 4.0	100
53310441	20,450	M 20	4 x 5.0	100
53320920	20,920	M 20	9 x 2.0	100
53320430	20,430	M 20	4 x 3.0	100
53325260	25,260	M 25	2 x 6.0	50
53325350	25,350	M 25	3 x 5.0	50
53325360	25,360	M 25	3 x 6.0	50
53325370	25,370	M 25	3 x 7.0	50
53325450	25,450	M 25	4 x 5.0	50
53325540	25,540	M 25	5 x 4.0	50
53325640	25,640	M 25	6 x 4.0	50
53332270	32,270	M 32	2 x 7.0	50
53332280	32,280	M 32	2 x 8.0	50
53332290	32,290	M 32	2 x 9.0	50
53332370	32,370	M 32	3 x 7.0	50
53332380	32,380	M 32	3 x 8.0	50
53332460	32,460	M 32	4 x 6.0	50
53332470	32,470	M 32	4 x 7.0	50
53332560	32,560	M 32	5 x 6.0	50
53332650	32,650	M 32	6 x 5.0	50
53332840	32,840	M 32	8 x 4.0	50
53332850	32,850	M 32	8 x 5.0	50
53332940	32,940	M 32	9 x 4.0	50
53340290	40,290	M 40	2 x 9.0	25
53340310	40,310	M 40	3 x 10.0	25
53340480	40,480	M 40	4 x 8.0	25
53340490	40,490	M 40	4 x 9.0	25
53340580	40,580	M 40	5 x 8.0	25
53340590	40,590	M 40	5 x 9.0	25
53340670	40,670	M 40	6 x 7.0	25
53340860	40,860	M 40	8 x 6.0	25
53340969	40,969	M 40	9 x 6.9	25
53350118	50,118	M 50	11 x 8.0	10
53350147	50,147	M 50	14 x 7.0	10
53350680	50,680	M 50	6 x 8.0	10
53350780	50,780	M 50	7 x 8.0	10
53350870	50,870	M 50	8 x 7.0	10
53350164	50,164	M 50	16 x 4.0	10
53350166	50,166	M 50	16 x 6.0	10
SKINTOP® DIX-M VITON®				
53420250	20,250	M 20	2 x 5.0	100
53420260	20,260	M 20	2 x 6.0	100
53440969	40,969	M 40	9 x 6.9	25

Accessories

- SKINTOP® CLICK see page 109
- SKINTOP® ST-M see page 107
- SKINTOP® DIX-DV

SKINTOP® DIX-M AUTOMATION



SKINTOP® DIX-M AUTOMATION

■ **Benefits**

- Optimum seal when using AS-I bus cables
- Easy insertion of pre assembled cables (with fieldbus or RJ-45 connector)
- Strain relief

■ **Application range**

- This seals can be used instead of our standard seals in the SKINTOP® cable glands.
- Switch cabinets
- Control panels
- Office applications
- Automation technology

■ **Approvals (Norm references)**



■ **Note**

- IP 68 can be achieved if the hole is optimally occupied, i. e. when using standard AS-I bus cables

■ **Design**

- True to dimension cut for AS-I bus cables
- Seal with hole and cut for easy insertion of pre assembled RJ-45 network cables
- Seal with hole and cut for easy insertion of pre assembled fieldbus cables
- Multiple seal inserts with holes and cuts for easy insertion of pre assembled cables

■ **Technical data**

RAL	Colour delivered RAL 9005 black
Material	NBR
IP	Degree of protection IP 54
Temperature	Range of temperature -40°C up to +100°C

Part number	Part designation / size	Number of cables x Cable Ø	Pieces / PU
SKINTOP® DIX-M ASI			
53611001	M 20	1 x AS-I	50
SKINTOP® DIX-M ASI DUO			
53611004	M 25	2 x AS-I	50
SKINTOP® DIX-M RJ-45			
53440980	M 25	1 x 5.4	50
SKINTOP® DIX-M FIELDBUS			
53440970	M 32	1 x 6.5	50
SKINTOP® DIX-M CUTTED			
53310444	M 40	3 x 10.0	25

■ **Accessories**

- SKINTOP® CLICK see page 109
- SKINTOP® ST-M see page 107

SKINDICHT® MINI

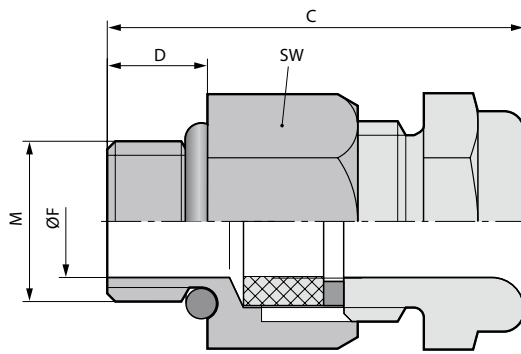

SKINDICHT® MINI

Benefits

- High degree of protection
- For smallest conductor sizes
- For small assembly space
- Gentle cable clamping
- High packaging density

Application range

- For use wherever there is limited assembly space.
- Sensors
- Measuring technology

Approvals (Norm references)



Technical data

- Material**
 Body: Nickel plated brass
 Seal: CR/NBR
- Degree of protection**
 IP 68
- Range of temperature**
 -20 °C up to +100 °C

Part number	Part designation / size	Clamping range ØF mm	SW mm	Overall length C mm	Thread length D mm	Pieces / PU
52001860	MINI 6 x 1	2 - 3	9	19.5	5.0	50
52001880	MINI 8 x 1	3,5 - 5,5	11	20.5	5.0	50



Source: PowerWind GmbH



SKINDICHT® CN-M



SKINDICHT® CN-M

■ Benefits

- For high temperatures
- Resistant against oils, solvents, acids and chemicals
- Sea water resistant
- For high mechanical stress
- Increased corrosion resistance

- Wind energy systems
- Brickyard

■ Approvals (Norm references)



■ Design

- Metric connection thread acc. to EN 50262

■ Note

- Suitable counter nut SKINDICHT® SM CrNi M please see chart

■ Technical data



Caution
 Installation dimensions see Appendix T21



Material
 Body: Chrome-nickel steel in accordance with DIN, material no. 1.4305
 Seal: FPM
 O-ring: FPM



Degree of protection
 IP 68



Range of temperature
 -25°C up to +200°C

■ Application range

- Chromium nickel steel cable gland with VITON® seal, specially designed for use under tough conditions.
- Pharmaceutical, petrochemical industry
- Off shore

Part number	Part designation / size	Clamping range ØF mm	SW mm	Overall length C mm	Thread length D mm	Pieces / PU
52032580	12 x 1,5/1	3,5 - 5	17	27,0	10,0	5
52032590	12 x 1,5/2	5 - 6,5	17	27,0	10,0	5
52032600	12 x 1,5/3	6,5 - 8	17	27,0	10,0	5
52032610	16 x 1,5	8 - 10,5	18	30,0	10,0	5
52032620	20 x 1,5	11 - 15	24	31,0	10,0	5
52032630	25 x 1,5	16 - 20,5	30	36,0	11,0	5
52032640	32 x 1,5	21 - 25,5	36	41,0	13,0	5
52032650	40 x 1,5	28,5 - 33	46	44,0	13,0	1
52032660	50 x 1,5	37 - 42	55	48,0	14,0	1
52032670	63 x 1,5	46 - 52	70	51,0	14,0	1
SKINDICHT® SM CrNi M counter nuts						
52032585	12 x 1,5	-	17	3,0	3,0	10
52032615	16 x 1,5	-	19	3,0	3,0	10
52032625	20 x 1,5	-	24	3,5	3,5	10
52032635	25 x 1,5	-	30	3,5	3,5	10
52032645	32 x 1,5	-	36	4,5	4,5	10
52032655	40 x 1,5	-	46	4,5	4,5	10
52032665	50 x 1,5	-	55	5,5	5,5	10
52032675	63 x 1,5	-	70	6,0	6,0	10

Viton® is a registered trademark of DuPont de Nemours



Source: PowerWind GmbH

New

SKINDICHT® SM-M



SKINDICHT® SM-M

Application range

- Needed wherever a gland has to be counter-sunk or thin walled housings only allow through holes.

Approvals (Norm references)



Design

- Metric connection thread acc. to EN 50262

Technical data

Material
Nickel-plated brass

Part number	Part designation / size	Thickness in mm	SW mm	Outer Ø mm	Pieces / PU
SKINDICHT® SM-M					
52103000	12 x 1,5	3.0	15	16.5	100
52103010	16 x 1,5	3.0	19	20.9	100
52103020	20 x 1,5	3.5	24	26.4	100
52103030	25 x 1,5	4.0	30	33.0	100
52103040	32 x 1,5	4.0	36	39.6	100
52103050	40 x 1,5	5.0	46	50.6	50
52103060	50 x 1,5	5.0	60	66.0	50
52103070	63 x 1,5	5.0	70	77.0	25
52103071	75 x 1,5	8.0	75	95.0	5
52103072	90 x 2	10.0	102	114.0	1
52103073	110 x 2	12.0	124	135.0	1

New

SKINDICHT® SM-PE-M



SKINDICHT® SM-PE-M

Benefits

- Cutting edges cut through the insulating layer, thus guaranteeing an optimum EMC contact
- Suitable for metric glands used in earthing and EMC applications

Approvals (Norm references)



Design

- Metric connection thread acc. to EN 50262

Technical data

Material
Nickel-plated brass

Application range

- For lacquered, anodised and powder coated housings.

Part number	Part designation / size	Thickness in mm	SW mm	Outer Ø mm	Pieces / PU
SKINDICHT® SM-PE-M					
52103300	12 x 1,5	3.5	15	16.5	100
52103310	16 x 1,5	3.5	19	20.9	100
52103320	20 x 1,5	3.7	24	26.4	100
52103330	25 x 1,5	4.2	30	33.0	50
52103340	32 x 1,5	4.7	36	39.6	50
52103350	40 x 1,5	5.5	46	50.6	25
52103360	50 x 1,5	5.5	60	66.0	10
52103370	63 x 1,5	7.0	70	77.0	10
52103371	75 x 1,5	8.0	75	95.0	5
52103372	90 x 2	10.0	102	114.0	1
52103373	110 x 2	12.0	124	135.0	1



SKINDICHT® BLK-M / SKINDICHT® BLK-GL-M



SKINDICHT® BLK-M

SKINDICHT® BLK-GL-M

■ **Benefits**

SKINDICHT® BLK-M

- Used wherever threads previously cut must be closed
- Economic solution

SKINDICHT® BLK-GL-M

- Enables the use of cable glands with smaller connection threads than the existing threaded holes
- High stability due to glass fibre reinforcement

■ **Application range**

SKINDICHT® BLK-M

- Switch cabinet building
- Junction box
- Connection box

SKINDICHT® BLK-GL-M

- Machines
- Devices
- Housings

■ **Approvals (Norm references)**



■ **Design**

- Metric connection thread acc. to EN 50262

■ **Note**

SKINDICHT® BLK-GL-M

- Assembled with O-ring, degree of protection IP 68

■ **Technical data**

i On request
SKINDICHT® BLK-M
 BLK-M with O-ring,
 black RAL 9005

RAL Colour delivered
SKINDICHT® BLK-M
 RAL 7035 light grey
SKINDICHT® BLK-GL-M
 RAL 7001 silver grey
 RAL 7035 light grey
 RAL 9005 black

Material
SKINDICHT® BLK-M
 Impact proof polystyrene
SKINDICHT® BLK-GL-M
 Nickel-plated brass

IP Degree of protection
 IP 54
 IP 68 with O-ring

Temperature Range of temperature
SKINDICHT® BLK-M
 -25°C up to +60°C
SKINDICHT® BLK-GL-M
 -60°C up to +200°C

Part number	Part designation / size	Thread length D mm	Pieces / PU
SKINDICHT® BLK-M			
52006600	12 x 1,5	6.0	100
52006610	16 x 1,5	6.0	100
52006620	20 x 1,5	6.0	100
52006630	25 x 1,5	8.0	100
52006640	32 x 1,5	8.0	50
52006650	40 x 1,5	8.0	25
52006660	50 x 1,5	10.0	25
52006670	63 x 1,5	12.0	25
SKINDICHT® BLK-GL-M silver-grey			
52006101	12 x 1,5	6.0	100
52006111	16 x 1,5	6.0	100
52006121	20 x 1,5	6.0	100
52006131	25 x 1,5	8.0	100
52006141	32 x 1,5	8.0	50
52006151	40 x 1,5	8.0	25
52006161	50 x 1,5	10.0	25
52006171	63 x 1,5	12.0	25
SKINDICHT® BLK-GL-M light grey			
52006100	12 x 1,5	6.0	100
52006110	16 x 1,5	6.0	100
52006120	20 x 1,5	6.0	100
52006130	25 x 1,5	8.0	100
52006140	32 x 1,5	8.0	50
52006150	40 x 1,5	8.0	25
52006160	50 x 1,5	10.0	25
52006170	63 x 1,5	12.0	25
SKINDICHT® BLK-GL-M black			
52006103	12 x 1,5	6.0	100
52006113	16 x 1,5	6.0	100
52006123	20 x 1,5	6.0	100
52006133	25 x 1,5	8.0	100
52006143	32 x 1,5	8.0	50
52006153	40 x 1,5	8.0	25
52006163	50 x 1,5	10.0	25
52006173	63 x 1,5	12.0	25
SKINDICHT® BLK-GL-M silver-grey mounted with O-ring			
52006109	12 x 1,5	6.0	100
52006119	16 x 1,5	6.0	100
52006129	20 x 1,5	6.0	100
52006139	25 x 1,5	8.0	100
52006149	32 x 1,5	8.0	50

Part number	Part designation / size	Thread length D mm	Pieces / PU
52006159	40 x 1,5	8.0	25
52006169	50 x 1,5	10.0	25
52006179	63 x 1,5	12.0	25
SKINDICHT® BLK-GL-M light grey mounted with O-ring			
52006107	12 x 1,5	6.0	100
52006117	16 x 1,5	6.0	100
52006127	20 x 1,5	6.0	100
52006137	25 x 1,5	8.0	100
52006147	32 x 1,5	8.0	50
52006157	40 x 1,5	8.0	25
52006167	50 x 1,5	10.0	25
52006177	63 x 1,5	12.0	25
SKINDICHT® BLK-GL-M black mounted with O-ring			
52006106	12 x 1,5	6.0	100
52006116	16 x 1,5	6.0	100
52006126	20 x 1,5	6.0	100
52006136	25 x 1,5	8.0	100
52006146	32 x 1,5	8.0	50
52006156	40 x 1,5	8.0	25
52006166	50 x 1,5	10.0	25
52006176	63 x 1,5	12.0	25



Source: PowerWind GmbH

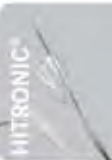

New

SKINTOP® CLICK BLK

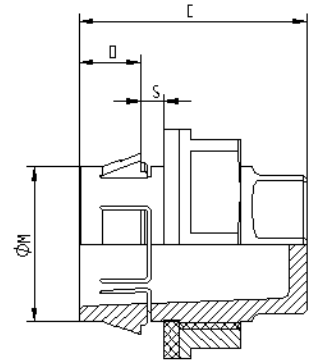
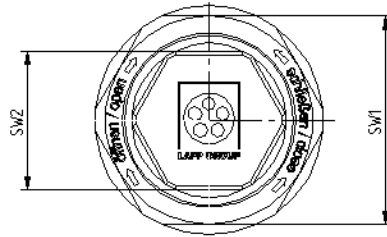

SKINTOP® CLICK BLK

Benefits

- Up to 70% time saving due to innovative CLICK system
- Simple, free assembly in any position
- Fewer parts, counter nut no longer needed
- No thread required
- Captive

- Switch cabinet building
- Measurement, control and electrical applications
- Automation technology
- Plant, apparatus construction

Approvals (Norm references)



Application range

- Blind plug with innovative CLICK system for fast installation in hardly accessible places. Perfect solution wherever threads previously cut must be closed.

Scope of delivery

- Disassembly tool contained in the delivery scope

Technical data

RAL	Colour delivered RAL 7035 light grey
Material	Body: special polyamide Seal: special elastomer
IP	Degree of protection IP 68 - 5 bar
0+1	Range of temperature -20°C up to +100°C

Part number	Part designation / size	M (hole mm)	SW1 / SW2 mm	Overall length C mm	Thread length D mm	S (wall thickness mm)	Pieces / PU
SKINTOP® CLICK BLK light grey							
52109013	CLICK BLK 16	16,3 (-0,2)	14 / 22	28,5	8,0	1,0 - 4,0	50
52109014	CLICK BLK 20	20,3 (-0,2)	18 / 27	29,5	8,0	1,0 - 4,0	25
52109015	CLICK BLK 25	25,3 (-0,2)	22 / 34	30,5	8,0	1,0 - 4,0	25

SKINDICHT® BL-M



SKINDICHT® BL-M

Benefits

- Used wherever threads previously cut must be closed
- Assembling with screw driver

Application range

- Machine and apparatus construction
- Drives

Approvals (Norm references)



Design

- Metric connection thread acc. to EN 50262

Technical data

- On request**
Fitted with FKM O-ring
- Material**
Blind plugs: Nickel plated brass
O-ring: NBR
- Degree of protection**
IP 54
IP 68 with O-ring
- Range of temperature**
With O-ring -30°C up to +100°C
Without O-ring -60°C up to +200°C

Part number	Part designation / size	Outer Ø mm	Pieces / PU
SKINDICHT® BL-M			
52103100	12 x 1,5	14.0	100
52103110	16 x 1,5	18.0	100
52103120	20 x 1,5	22.0	100
52103130	25 x 1,5	28.0	100
52103140	32 x 1,5	35.0	50
52103150	40 x 1,5	44.0	25
52103160	50 x 1,5	54.0	10
52103170	63 x 1,5	70.0	10
SKINDICHT® BL-M with O-ring			
52103105	12 x 1,5	14.0	100
52103115	16 x 1,5	18.0	100
52103125	20 x 1,5	22.0	100
52103135	25 x 1,5	28.0	100
52103145	32 x 1,5	35.0	50
52103155	40 x 1,5	44.0	25
52103165	50 x 1,5	54.0	10
52103175	63 x 1,5	70.0	10
52103190	75 x 1,5	80.0	1



SKINDICHT® BL-M hexagonal



Benefits

- Used wherever threads previously cut must be closed
- High degree of protection

Application range

- Machine and apparatus construction
- Drives

Approvals (Norm references)



Design

- Metric connection thread acc. to EN 50262

Note

- Blind plug chromium nickel steel on request

Technical data



On request

Viton® O-ring
-20°C up to +200°C



Material

Body: Nickel plated brass
O-Ring: NBR



Degree of protection

IP 68



Range of temperature

-30°C up to +100°C

Part number	Part designation / size	SW mm	Outer Ø mm	Pieces / PU
SKINDICHT® BL-M hexagon				
52103405	12 x 1,5	16	17,8	50
52103415	16 x 1,5	20	22,0	50
52103425	20 x 1,5	24	26,4	50
52103435	25 x 1,5	29	31,9	50
52103445	32 x 1,5	36	39,6	25
52103455	40 x 1,5	45	49,5	25
52103465	50 x 1,5	54	59,0	10
52103475	63 x 1,5	67	73,5	10

Viton® is a registered trademark of DuPont de Nemours

The Lapp connectors for wind power incorporate more than 30 years of experience. For years, our global solutions for customer-specific applications and forward-looking innovations have set new standards in the passive components market.

The heavy-duty EPIC® rectangular connectors are designed for reliable connection and disconnection. Product details such as low-friction bolts, robust metal covers, a robust powder coating, passive silver plated contacts or, alternatively, gold plated contacts are all designed especially for wind power applications. This guarantees a reliable connection and a long service life.

EPIC® circular connectors are developed for all measuring, control and regulation applications in wind turbines. The compact design combined with high protection class (IP 68) make these connectors ideal for rotary encoders and servo motors in pitch drives. The high quality materials used – such as gold plated contacts, high quality FKM seals and an integrated EMC blade fittings – guarantee maximum reliability and durability. Accessories such as adapters for connecting a SILVYN® protective tube and metal screw caps round off the range.

The design of all EPIC® connectors reflects all of the relevant standards. The most important standards for connectors are the European IEC 61984 (VDE), the American UL 1977 (UR) and the Canadian CSA-C222.2 No. 182.3. This results in products that can be used in all international markets.

EPIC®

Industrial connectors



EPIC® industrial connectors

Rectangular connector kits - INFORMATION SHEET: Please see our current main 2008/2009 catalogue for all technical data and approvals



Image	Item no.	Description of insert	Description of housing	Nr. of contacts	Thread
H-A 3 kits/plastic housing					
	75009601	H-A 3 SS male insert, screw termination	H-A 3 MTgv M20 hood, straight cable entry	3 + PE	M20
	75009603	H-A 3 SS male insert, screw termination	H-A 3 MTs M20 hood, side cable entry	3 + PE	M20
	75009605	H-A 3 BS female insert, screw termination	H-A 3 Mag panel mount base, straight	3 + PE	
	75009607	H-A 3 BS female insert, screw termination	H-A 3 Mags panel mount base, angled	3 + PE	
	75009609	H-A 3 BS female insert, screw termination	H-A 3 MAgsv M20 surface mount base, 1 cable entry	3 + PE	M20
	75009611	H-A 3 BS female insert, screw termination	H-A 3 Tgvb M20, cable coupler hood, straight cable entry	3 + PE	M20
H-A 3 kits/metal housing					
	75009602	H-A 3 SS male insert, screw termination	H-A 3 MTgv M20 hood, straight cable entry	3 + PE	M20
	75009604	H-A 3 SS male insert, screw termination	H-A 3 MTs M20 hood, side cable entry	3 + PE	M20
	75009606	H-A 3 BS female insert, screw termination	H-A 3 Mag panel mount base, straight	3 + PE	
	75009608	H-A 3 BS female insert, screw termination	H-A 3 Mags panel mount base, angled	3 + PE	
	75009610	H-A 3 BS female insert, screw termination	H-A 3 MAgsv M20 surface mount base, 1 cable entry	3 + PE	M20
	75009612	H-A 3 BS female insert, screw termination	H-A 3 MTgvb M20, cable coupler hood, straight cable entry	3 + PE	M20
H-A 4 kits/plastic housing					
	75009613	H-A 4 SS male insert, screw termination	H-A 4 MTgv M20 hood, straight cable entry	4 + PE	M20
	75009615	H-A 4 SS male insert, screw termination	H-A 4 MTs M20 hood, side cable entry	4 + PE	M20
	75009617	H-A 4 BS female insert, screw termination	H-A 3 Mag panel mount base, straight	4 + PE	
	75009619	H-A 4 BS female insert, screw termination	H-A 3 Mags panel mount base, angled	4 + PE	
	75009621	H-A 4 BS female insert, screw termination	H-A 3 MAgsv M20 surface mount base, 1 cable entry	4 + PE	M20
	75009623	H-A 4 BS female insert, screw termination	H-A 3 Tgvb M20, cable coupler hood, straight cable entry	4 + PE	M20
H-A 4 kits/metal housing					
	75009614	H-A 4 SS male insert, screw termination	H-A 4 MTgv M20 hood, straight cable entry	4 + PE	M20
	75009616	H-A 4 SS male insert, screw termination	H-A 4 MTs M20 hood, side cable entry	4 + PE	M20
	75009618	H-A 4 BS female insert, screw termination	H-A 3 Mag panel mount base, straight	4 + PE	
	75009620	H-A 4 BS female insert, screw termination	H-A 3 Mags panel mount base, angled	4 + PE	
	75009622	H-A 4 BS female insert, screw termination	H-A 3 MAgsv M20 surface mount base, 1 cable entry	4 + PE	M20
	75009624	H-A 4 BS female insert, screw termination	H-A 3 MTgvb M20, cable coupler hood, straight cable entry	4 + PE	M20



Image	Item no.	Description of insert	Product name	Nr. of contacts	Thread
H-A 10 kits/metal housing					
	75009625	H-A 10 SS male insert, screw termination with wire protection	H-A 10 TG M20 hood, straight cable entry	10 + PE	M20
	75009626	H-A 10 SS male insert, screw termination with wire protection	H-A 10 TG M20 hood, side cable entry	10 + PE	M20
	75009627	H-A 10 BS female insert, screw termination with wire protection	H-A 10 AG-LB panel mount base	10 + PE	
	75009628	H-A 10 BS female insert, screw termination with wire protection	H-A 10 SGR-LB M20 surface mount base, 1 cable entry	10 + PE	M20
	75009629	H-A 10 BS female insert, screw termination with wire protection	H-A 10 TBF-LB M20 cable coupler hood, straight cable entry	10 + PE	M20
H-A 16 kits/metal housing					
	75009630	H-A 16 SS male insert, screw termination with wire protection	H-A 16 TG M20 hood, straight cable entry	16 + PE	M20
	75009631	H-A 16 SS male insert, screw termination with wire protection	H-A 16 TG M20 hood, side cable entry with intermediate piece	16 + PE	M20
	75009632	H-A 16 BS female insert, screw termination with wire protection	H-A 16 AG-LB panel mount base	16 + PE	
	75009633	H-A 16 BS female insert, screw termination with wire protection	H-A 16 SGR-LB M20 surface mount base, 1 cable entry	16 + PE	M20
	75009634	H-A 16 BS female insert, screw termination with wire protection	H-A 16 TBF-LB M20 cable coupler hood, straight cable entry	16 + PE	M20



Image	Item no.	Description of insert	Product name	Nr. of contacts	Thread
H-BE 6 kits/metal housing					
	75009635	H-BE 6 SS male insert, screw termination with wire protection	H-B 6 TG M20 hood, straight cable entry, bolts for single lever	6 + PE	M20
	75009636	H-BE 6 SS male insert, screw termination with wire protection	H-B 6 TS M20 hood, side cable entry with intermediate piece, bolts for single lever	6 + PE	M20
	75009637	H-BE 6 BS female insert, screw termination with wire protection	H-B 6 AG-LB panel mount base, single lever	6 + PE	
	75009638	H-BE 6 BS female insert, screw termination with wire protection	H-B 6 SGR M20 surface mount base, 1 cable entry, single lever	6 + PE	M20
	75009639	H-BE 6 BS female insert, screw termination with wire protection	H-B 6 TBF M20 cable coupler hood, straight cable entry, single lever	6 + PE	M20
H-BE 10 kits/metal housing					
	75009640	H-BE 10 SS male insert, screw termination with wire protection	H-B 10 TG M25 hood, straight cable entry, bolts for double lever	10 + PE	M25
	75009641	H-BE 10 SS male insert, screw termination with wire protection	H-B 10 TS M25 hood, side cable entry with intermediate piece, bolts for double lever	10 + PE	M25
	75009642	H-BE 10 BS female insert, screw termination with wire protection	H-B 10 AG panel mount base, double lever	10 + PE	
	75009643	H-BE 10 BS female insert, screw termination with wire protection	H-B 10 SGR M25 surface mount base, 1 cable entry, double lever	10 + PE	M25
	75009644	H-BE 10 BS female insert, screw termination with wire protection	H-B 10 TBF M25 cable coupler hood, straight cable entry, double lever	10 + PE	M25
H-BE 16 kits/metal housing					
	75009645	H-BE 16 SS male insert, screw termination with wire protection	H-B 16 TG M25 hood, straight cable entry, bolts for double lever	16 + PE	M25
	75009646	H-BE 16 SS male insert, screw termination with wire protection	H-B 16 TS M25 hood, side cable entry with intermediate piece, bolts for double lever	16 + PE	M25
	75009647	H-BE 16 BS female insert, screw termination with wire protection	H-B 16 AG panel mount base, double lever	16 + PE	
	75009648	H-BE 16 BS female insert, screw termination with wire protection	H-B 16 SGR M25 surface mount base, 1 cable entry, double lever	16 + PE	M25
	75009649	H-BE 16 BS female insert, screw termination with wire protection	H-B 16 TBF M25 cable coupler hood, straight cable entry, double lever	16 + PE	M25
H-BE 24 kits/metal housing					
	75009650	H-BE 24 SS male insert, screw termination with wire protection	H-B 24 TG M25 hood, straight cable entry, bolts for double lever	24 + PE	M25
	75009651	H-BE 24 SS male insert, screw termination with wire protection	H-B 24 TS M25 hood, side cable entry with intermediate piece, bolts for double lever	24 + PE	M25
	75009652	H-BE 24 BS female insert, screw termination with wire protection	H-B 24 AG panel mount base, double lever	24 + PE	
	75009653	H-BE 24 BS female insert, screw termination with wire protection	H-B 24 SGR M25 surface mount base, 1 cable entry, double lever	24 + PE	M25
	75009654	H-BE 24 BS female insert, screw termination with wire protection	H-B 24 TBF M25 cable coupler hood, straight cable entry, double lever	24 + PE	M25
H-BS 6 kits/metal housing					
	75009655	H-BS 6 SS male insert, screw termination with wire protection	H-B 16 TG M25 hood, straight cable entry, bolts for double lever	6 + PE	M25
	75009656	H-BS 6 SS male insert, screw termination with wire protection	H-B 16 TS M25 hood, side cable entry with intermediate piece, bolts for double lever	6 + PE	M25
	75009657	H-BS 6 BS female insert, screw termination with wire protection	H-B 16 AG panel mount base, double lever	6 + PE	
	75009658	H-BS 6 BS female insert, screw termination with wire protection	H-B 16 SGR M25 surface mount base, 1 cable entry, double lever	6 + PE	M25
	75009659	H-BS 6 BS female insert, screw termination with wire protection	H-B 16 TBF M25 cable coupler hood, straight cable entry, double lever	6 + PE	M25

EPIC® industrial connectors

Circular connector kits · INFORMATION SHEET: Please see our current main 2008/2009 catalogue for all technical data and approvals

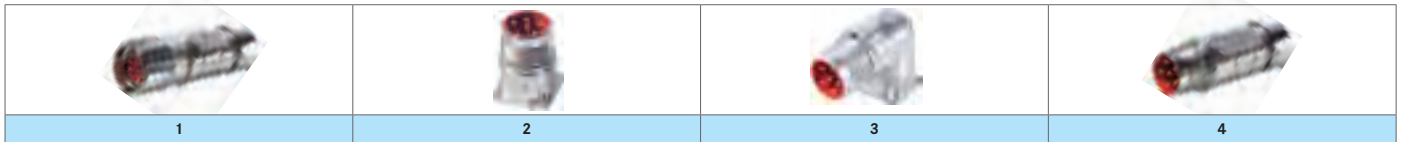

Image	Item no.	Description	Nr of contacts	Clamping range
LS 1 kits 6 contacts/metal housing				
1	75009690	LS 1 D6 cable connector incl. 2 mm female contacts, 6 contacts	5 + PE	7.5 - 15.5 mm
2	75009691	LS 1 A1 front wall mounting incl. 2 mm male contacts, 6 contacts	5 + PE	
3	75009692	LS 1 A3 angled wall mounting, rotatable, incl. 2 mm male contacts, 6 contacts	5 + PE	
4	75009693	LS 1 F6 cable coupler incl. 2 mm male contacts, 6 contacts	5 + PE	7.5 - 15.5 mm
LS 1 kits 8 contacts/metal housing				
1	75009694	LS 1 D6 cable connector incl. 4 x 2 mm and 4 x 1 mm female contacts, 8 contacts	3 + PE + 4	7.5 - 15.5 mm
2	75009695	LS 1 A1 front wall mounting incl. 4 x 2 mm and 4 x 1 mm male contacts, 8 contacts	3 + PE + 4	
3	75009696	LS 1 A3 angled wall mounting, rotatable, incl. 4 x 2 mm and 4 x 1 mm male contacts, 8 contacts	3 + PE + 4	
4	75009697	LS 1 F6 cable coupler incl. 4 x 2 mm and 4 x 1 mm male contacts, 8 contacts	3 + PE + 4	7.5 - 15.5 mm



Image	Item no.	Description	Nr of contacts	Clamping range	
M23 kits 8 + 1 contact/metal housing					
1 and 3	75009698	M23 D6 cable connector, N-coded	Female insert M23, P part, 8 + 1 contact, incl. 8 x 1 mm and 1 x 2 mm female contacts with soldering tags	8 + 1	7.0 - 13.5 mm
2 and 4	75009699	M23 A1 front wall mounting, N-coded	Male insert M23, E part, 8 + 1 contact, incl. 8 x 1 mm and 1 x 2 mm male contacts with soldering tags	8 + 1	
2 and 5	75009700	M23 A3 front wall mounting, angled, rotatable, N-coded	Male insert M23, E part, 8 + 1 contact, incl. 8 x 1 mm and 1 x 2 mm male contacts with soldering tags	8 + 1	
2 and 6	75009701	M23 F6 coupling connector, N-coded	Male insert M23, E part, 8 + 1 contact, incl. 8 x 1 mm and 1 x 2 mm male contacts with soldering tags	8 + 1	7.0 - 13.5 mm
M23 kits 12 contacts/metal housing					
1 and 3	75009702	M23 D6 cable connector, N-coded	M23 female insert, P part, 12 contacts, incl. 12 x 1 mm female contacts with soldering tags	12	7.0 - 13.5 mm
2 and 4	75009703	M23 A1 front wall mounting, N-coded	M23 male insert, E part, 12 contacts, incl. 12 x 1 mm male contacts with soldering tags	12	
2 and 5	75009704	M23 A3 angled wall mounting, rotatable, N-coded	M23 male insert, E part, 12 contacts, incl. 12 x 1 mm male contacts with soldering tags	12	
2 and 6	75009705	M23 F6 coupling connector, N-coded	M23 male insert, E part, 12 contacts, incl. 12 x 1 mm male contacts with soldering tags	12	7.0 - 13.5 mm
M23 kits 17 contacts/metal housing					
1 and 3	75009706	M23 D6 cable connector, N-coded	M23 female insert, P part, 17 contacts, incl. 17 x 1 mm female contacts with soldering tags	17	7.0 - 13.5 mm
2 and 4	75009707	M23 A1 front wall mounting, N-coded	M23 male insert, E part, 17 contacts, incl. 17 x 1 mm male contacts with soldering tags	17	
2 and 5	75009708	M23 A3 angled wall mounting, rotatable, N-coded	M23 male insert, E part, 17 contacts, incl. 17 x 1 mm male contacts with soldering tags	17	
2 and 6	75009709	M23 F6 coupling connector, N-coded	M23 male insert, E part, 17 contacts, incl. 17 x 1 mm male contacts with soldering tags	17	7.0 - 13.5 mm



Image	Item no.	Description
Tool		
1	11148000	4-mandrel crimping tool
2	11148001	4-mandrel crimping tool, digital
3	11148300	Locator for EPIC CIRCON
4	75017400	LS 1 removal tool for 1 mm contacts
4	75017500	LS 1 removal tool for 2 mm contacts
5	44420078	M23 removal tool for insert



Source: PowerWind GmbH

Cables from Lapp feature the very highest standards in terms of quality and reliability. The high quality insulation materials make Lapp the number 1 name for machine manufacturers and plant engineering. Despite this, in many areas the protective insulation on a cable is insufficient to guarantee a permanent and secure connection. Especially for these demanding areas, Lapp supplies its SILVYN® protective tube systems, offering optimum protection against harsh conditions. The universally compatible protective tube systems cover almost every conceivable type of fault – they protect against mechanical and chemical influences and against heat and electromagnetic interference. SILVYN® protective tube systems face any challenge and their international approvals mean that they are in use all over the world.

SILVYN®

Protective cable conduit- and cable carrier systems



SILVYN® RILL PA 6



Info

- Highest safety in case of fire



SILVYN® RILL PA 6

Benefits

- Dimensionally stable
- Flexible
- Highly flame-retardant and self-extinguishing in accordance with UL94 V0
- Compression resistant
- Slim weight

Application range

- Mechanical engineering
- Public utilities
- Railway applications / vehicle construction
- Flexible application
- Outdoor application (in black colour)

Product features

- Halogen and cadmium-free
- Abrasion resistant
- Increased resistance against oil, petrol, acids and other chemicals

Approvals (Norm references)



- UL FILENUMBER E308201
- DNV

Design

- Fine profil corrugated polyamide 6 conduit

Note

- UV and weather resistant in black

Technical data

Approvals
 UR File No. E308201
 VDE, KEMA, DNV,
 Rail:
 GGVS, DB, SNCF
 UNDERGROUND

Colour delivered
 Grey
 Black, UV-resistant

Material
 PA 6
 Silicon free
 Halogen free
 UL94 V0

Range of temperature
 -40°C up to +115°C

Part number	Article designation	Part IØ x AØ mm	Bending radius mm	Suitable for SILVYN® KLICK-GM/WM	Suitable for SILVYN® KLICK-GP/WP	Suitable for SILVYN® KLICK-GPZ-M/GPZ	PU ring in m
SILVYN® RILL PA 6 grey							
61746939	7	6.5 x 10.0	13	10 x 1,0	7/-	12 x 1,5/7	50
61746940	9	10.0 x 13.0	20	12 x 1,5/ 16 x 1,5	9/9	16x1,5/9	50
61746950	11	12.0 x 15.8	35	16 x 1,5/20 x 1,5	11/11	20x1,5/11	50
61747010	13,5	14.3 x 18.5	40		13,5/13,5	-/13,5	50
61746960	16	16.5 x 21.2	45	20 x 1,5	16/16	25x1,5/16	50
61746970	21	23.0 x 28.5	55	25 x 1,5	21/21	32x1,5/21	50
61746980	29	29.0 x 34.5	65	32 x 1,5	29/29	40x1,5/29	25
61746990	36	36.0 x 42.5	90	40 x 1,5	36/-	50x1,5/36	25
61747000	48	48.0 x 54.5	100	50 x 1,5	48/-	63x1,5/48	25
SILVYN® RILL PA 6 black							
61746935	7	6.5 x 10.0	13	10 x 1,0	7/-	12 x 1,5/7	50
61746945	9	10.0 x 13.0	20	12 x 1,5/ 16 x 1,5	9/9	16x1,5/9	50
61746955	11	12.0 x 15.8	35	16 x 1,5/20 x 1,5	11/11	20x1,5/11	50
61747015	13,5	14.3 x 18.5	40		13,5/13,5	-/13,5	50
61746965	16	16.5 x 21.2	45	20 x 1,5	16/16	25x1,5/16	50
61746975	21	23.0 x 28.5	55	25 x 1,5	21/21	32x1,5/21	50
61746985	29	29.0 x 34.5	65	32 x 1,5	29/29	40x1,5/29	25
61746995	36	36.0 x 42.5	90	40 x 1,5	36/-	50x1,5/36	25
61747005	48	48.0 x 54.5	100	50 x 1,5	48/-	63x1,5/48	25

Comparable products

- SILVYN® RILL PA 12 see page 132

Accessories

- SILVYN® KLICK-GM see page 133
- SILVYN® KLICK-WM see page 134
- SILVYN® KLICK GPZ-M
- SILVYN® KLICK-WF
- SILVYN® KSE
- SILVYN® KLICK-GP
- SILVYN® KLICK-WP
- SILVYN® KLICK-GPZ
- SILVYN® KLICK-Y
- SILVYN® KLICK-Y (TPE)
- SILVYN® KLICK-S
- SILVYN® KLICK-D
- SILVYN® KLICK-V
- SILVYN® KLICK-RH
- SILVYN® K-EM



SILVYN® RILL PA 12



SILVYN® RILL PA 12

■ Benefits

- Dimensionally stable
- Highly flexible / cold flexible
- Flame retardant and self-extinguishing in accordance with UL94 V2
- Compression resistant
- Highly bendable

■ Application range

- Mechanical engineering
- In drag chains (SILVYN® CHAIN)
- Building automation
- Robot building
- Outdoor application (in black colour)

■ Product features

- Halogen and cadmium-free
- Abrasion resistant
- Increased resistance against oil, petrol, acids and other chemicals

■ Approvals (Norm references)



- Railway: DB, SNCF

■ Design

- Fine profil corrugated polyamide 12 conduit

■ Note

- UV and weather resistant in black

■ Technical data



Approvals

Railway:
DB, SNCF



Colour delivered

Grey
Black, UV-resistant



Material

PA 12
silicon free
halogen-free
UL94 V2



Range of temperature

-50 °C to +100 °C

Part number	Article designation	Part IØ x AØ mm	Bending radius mm	Suitable for SILVYN® KLICK-GM/WM	Suitable for SILVYN® KLICK-GP/WP	Suitable for SILVYN® KLICK-GPZ-M/GPZ	PU ring in m
SILVYN® RILL PA 12 grey							
61815100	7	6.5 x 10.0	13	10 x 1,5	7/-	12 x 1,5/7	50
61815110	9	10.0 x 13.0	15	12 x 1,5/16 x 1,5	9/9	16x1,5/9	50
61815120	11	12.0 x 15.8	22	16 x 1,5/20 x 1,5	11/11	20x1,5/11	50
61815180	13,5	14.3 x 18.5	27		13,5/13,5	-/13,5	50
61815130	16	16.5 x 21.2	35	20 x 1,5	16/16	25x1,5/16	50
61815140	21	23.0 x 28.5	45	25 x 1,5	21/21	32x1,5/21	50
61815150	29	29.0 x 34.5	50	32 x 1,5	29/29	40x1,5/29	25
61815160	36	36.0 x 42.5	80	40 x 1,5	36/-	50x1,5/36	25
61815170	48	48.0 x 54.5	100	50 x 1,5	48/-	63x1,5/48	25
SILVYN® RILL PA 12 black							
61815105	7	6.5 x 10.0	13	10 x 1,5	7/-	12 x 1,5/7	50
61815115	9	10.0 x 13.0	15	12 x 1,5/16 x 1,5	9/9	16x1,5/9	50
61815125	11	12.0 x 15.8	22	16 x 1,5/20 x 1,5	11/11	20x1,5/11	50
61815185	13,5	14.3 x 18.5	27		13,5/13,5	-/13,5	50
61815135	16	16.5 x 21.2	35	20 x 1,5	16/16	25x1,5/16	50
61815145	21	23.0 x 28.5	45	25 x 1,5	21/21	32x1,5/21	50
61815155	29	29.0 x 34.5	50	32 x 1,5	29/29	40x1,5/29	25
61815165	36	36.0 x 42.5	80	40 x 1,5	36/-	50x1,5/36	25
61815175	48	48.0 x 54.5	100	50 x 1,5	48/-	63x1,5/48	25

■ Comparable products

- SILVYN® RILL PA 6 see page 131

■ Accessories

- SILVYN® KLICK-GM see page 133
- SILVYN® KLICK-WM see page 134
- SILVYN® KLICK GPZ-M
- SILVYN® KLICK-WF
- SILVYN® KSE
- SILVYN® KLICK-GP
- SILVYN® KLICK-WP
- SILVYN® KLICK-GPZ
- SILVYN® KLICK-Y
- SILVYN® KLICK-Y (TPE)
- SILVYN® KLICK-S
- SILVYN® KLICK-D
- SILVYN® KLICK-V
- SILVYN® KLICK-RH
- SILVYN® K-EM

SILVYN® KLICK-GM

Benefits

- Fast mounting
- Easy unassembling
- Tensile strength
- Highly sealing
- Swivelable

Application range

- In combination with protective conduit
- SILVYN® RILL PA6
- SILVYN® RILL PA12
- Robot building
- Swivelable applications

Approvals (Norm references)



- UL FILENUMBER E308201

Design

- Metrical connection thread
- Body with inner sealing
- Upper part with snap-in sleeve

Note

- For swivelable applications unassemble upper part, remove sealing, assemble upper part

Technical data

RAL	Colour delivered Grey Black, UV-resistant
Material	PA
IP	Degree of protection IP 68 IP 69K according DIN 40050 T.9
Temperature	Range of temperature -30 °C up to +100 °C



Part number	Connection thread M	Hole-Ø mm	For flexible conduit outside Ø mm	Thread length D mm	SW mm	Suitable for SILVYN® RILL	Pieces / PU
SILVYN® KLICK-GM grey							
55501000	10 x 1,0	6,5	10,0	12,0	17,0	6,5 x 10,0	50
55501010	12 x 1,5	8,0	13,0	12,0	20,0	10 x 13,0	50
55501020	16 x 1,5/1	10,0	13,0	12,0	20,0	10 x 13,0	50
55501030	16 x 1,5/2	12,0	15,8	12,0	23,0	12 x 15,8	50
55501040	20 x 1,5/1	12,0	15,8	13,0	23,0	12 x 15,8	50
55501050	20 x 1,5/2	16,0	21,2	13,0	29,5	16,5 x 21,2	50
55501060	25 x 1,5	20,5	28,5	13,0	37,0	23 x 28,5	25
55501070	32 x 1,5	27,5	34,5	15,0	44,0	29 x 34,5	25
55501080	40 x 1,5	35,0	42,5	15,0	51,5	36 x 42,5	25
55501090	50 x 1,5	45,0	54,5	15,3	65,5	48 x 54,5	10
55500990	63 x 1,5	48,0	54,5	16,0	59,0	48 x 54,5	10
SILVYN® KLICK-GM black							
55501005	10 x 1,0	6,5	10,0	12,0	17,0	6,5 x 10,0	50
55501015	12 x 1,5	8,0	13,0	12,0	20,0	10 x 13,0	50
55501025	16 x 1,5/1	10,0	13,0	12,0	20,0	10 x 13,0	50
55501035	16 x 1,5/2	12,0	15,8	12,0	23,0	12 x 15,8	50
55501045	20 x 1,5/1	12,0	15,8	13,0	23,0	12 x 15,8	50
55501055	20 x 1,5/2	16,0	21,2	13,0	29,5	16,5 x 21,2	50
55501065	25 x 1,5	20,5	28,5	13,0	37,0	23 x 28,5	25
55501075	32 x 1,5	27,5	34,5	15,0	44,0	29 x 34,5	25
55501085	40 x 1,5	35,0	42,5	15,0	51,5	36 x 42,5	25
55501095	50 x 1,5	45,0	54,5	15,3	65,5	48 x 54,5	10
55500995	63 x 1,5	48,0	54,5	16,0	59,0	48 x 54,5	10

Comparable products

- SILVYN® KLICK GPZ-M see page [P1158]



SILVYN® KLICK-WM



Benefits

- 90° elbow enables best assembling
- Fast mounting
- Easy unassembling
- Tensile strength
- Highly sealing

Application range

- In combination with protective conduit
- SILVYN® RILL PA6
- SILVYN® RILL PA12
- For less space applications
- Swivelable applications

Approvals (Norm references)



- UL FILENUMBER E308201

Design

- Metrical connection thread
- 90° elbow
- Body with inner sealing
- Upper part with snap-in sleeve

Note

- For swivelable applications unassemble upper part, remove sealing, assemble upper part

Technical data

RAL	Colour delivered Grey Black, UV-resistant
	Material PA
IP	Degree of protection IP 67
	Range of temperature -30 °C up to +100 °C

Part number	Connection thread M	Hole-Ø mm	For flexible conduit outside Ø mm	Thread length D mm	Suitable for SILVYN® RILL	Pieces / PU
SILVYN® KLICK-WM grey						
55501110	10 x 1,0	7.0	10.0	12.0	6,5 x 10	50
55501120	12 x 1,5	8.0	13.0	12.0	10 x 13	50
55501130	16 x 1,5/1	12.0	13.0	12.0	10 x 13	50
55501140	16 x 1,5/2	12.0	15.8	12.0	12 x 15,8	50
55501150	20 x 1,5/1	15,5	15.8	13.0	12 x 15,8	50
55501160	20 x 1,5/2	15,5	21.2	13.0	16,5 x 21,2	50
55501170	25 x 1,5/1	18.0	21.2	13.0	16,5 x 21,2	50
55501180	25 x 1,5/2	18.0	28.5	13.0	23 x 28,5	25
55501190	32 x 1,5/1	24.0	28.5	15.0	23 x 28,5	25
55501200	32 x 1,5/2	24.0	34.5	15.0	29 x 34,5	10
55501210	40 x 1,5/1	32.0	34.5	15.0	29 x 34,5	10
55501220	40 x 1,5/2	32.0	42.5	15.0	36 x 42,5	10
55501230	50 x 1,5/1	39.0	42.5	16.0	36 x 42,5	10
55501240	50 x 1,5/2	39.0	54.5	16.0	48 x 54,5	5
55501250	63 x 1,5	53.0	54.5	16.0	48 x 54,5	5
SILVYN® KLICK-WM black						
55501115	10 x 1,0	7.0	10.0	12.0	6,5 x 10	50
55501125	12 x 1,5	8.0	13.0	12.0	10 x 13	50
55501135	16 x 1,5/1	12.0	13.0	12.0	10 x 13	50
55501145	16 x 1,5/2	12.0	15.8	12.0	12 x 15,8	50
55501155	20 x 1,5/1	15,5	15.8	13.0	12 x 15,8	50
55501165	20 x 1,5/2	15,5	21.2	13.0	16,5 x 21,2	50
55501175	25 x 1,5/1	18.0	21.2	13.0	16,5 x 21,2	50
55501185	25 x 1,5/2	18.0	28.5	13.0	23 x 28,5	25
55501195	32 x 1,5/1	24.0	28.5	15.0	23 x 28,5	25
55501205	32 x 1,5/2	24.0	34.5	15.0	29 x 34,5	10
55501215	40 x 1,5/1	32.0	34.5	15.0	29 x 34,5	10
55501225	40 x 1,5/2	32.0	42.5	15.0	36 x 42,5	10
55501235	50 x 1,5/1	39.0	42.5	16.0	36 x 42,5	10
55501245	50 x 1,5/2	39.0	54.5	16.0	48 x 54,5	5
55501255	63 x 1,5	53.0	54.5	16.0	48 x 54,5	5

Comparable products

- SILVYN® KLICK-WF
- SILVYN® KF-M

SILVYN® SSUE



Benefits

- Tensile strength
- Corrosion resistant
- Flexible
- For heavy mechanical stress
- Heat resistant

Application range

- Off shore applications
- Measuring technology
- Plant engineering
- Outdoors application
- Applications with mechanical stress

Product features

- Stainless steel AISI316

Approvals (Norm references)



- UNDERGROUND

Design

- Spirally wound stainless steel protective conduit with roughenged profile

Note

- Sizes 10.12 with double-linked

Technical data

Approvals
Railway:
UNDERGROUND
Link-up

Note
Sizes 10.12 with double-linked

Material
Stainless steel AISI316

Degree of protection
IP 40

Range of temperature
-100°C bis +400°C

Part number	Article designation	Internal Ø x External Ø in mm	Bending radius mm	Inner Ø in mm	Suitable for SILVYN® LGEF-M/LGES-M	PU ring in m
SILVYN® SSUE						
61804600	10	6.8 x 9.0	25	6.8	M 12 x 1,5	25
61804601	12	10.2 x 13.0	30	10.2	M 16 x 1,5/1	25
61804602	16	13.0 x 16.0	40	13.0	M 16 x 1,5/2	25
61804603	20	16.9 x 20.5	45	16.9	M 20 x 1,5/1	25
61804604	25	21.1 x 25.0	55	21.1	M 25 x 1,5	25
61804605	32	28.1 x 32.0	70	28.1	M 32 x 1,5	25

Comparable products

- SILVYN® UI 511

Accessories

- SILVYN® LGES-M see page 136
- SILVYN® LGEF-M see page 136



SILVYN® LGES-M / SILVYN® LGEF-M



SILVYN® LGES-M

SILVYN® LGEF-M

■ Benefits

SILVYN® LGES-M

- Corrosion resistant
- For swivelable applications
- High tensile strength
- Saving space

SILVYN® LGEF-M

- Corrosion resistant
- For fixed applications
- High tensile strength
- Saving space

■ Application range

- In combination with protective conduit
- Protective cable conduit system SILVYN® SSUE
- Off shore applications
- Outdoors application

- Applications with mechanical stress

■ Product features

- Stainless steel AISI316

■ Approvals (Norm references)



■ Design

SILVYN® LGES-M

- Metrical connection thread
- Hexagonal collar with swivel
- Cap nut

SILVYN® LGEF-M

- Metrical connection thread
- Hexagonal collar
- Cap nut

■ Technical data

	Material Stainless steel AISI316
	Degree of protection IP 40
	Range of temperature -100°C bis +400°C

Part number	Article designation	Overall length C mm	Thread length D mm	SW mm	Suitable for SILVYN® SSUE	Pieces / PU
SILVYN® LGES-M						
55503210	12 x 1,5	30.2	7.0	14.0	10	1
55503211	16 x 1,5/1	35.5	10.0	19.0	12	1
55503212	16 x 1,5/2	35.5	10.0	19.0	16	1
55503213	20 x 1,5/1	38.5	10.0	24.0	20	1
55503214	25 x 1,5	41.5	12.0	29.0	25	1
55503215	32 x 1,5	49.0	13.0	38.0	32	1
SILVYN® LGEF-M						
55503200	12 x 1,5	21.0	7.0	14.0	10	1
55503201	16 x 1,5/1	26.0	10.0	19.0	12	1
55503202	16 x 1,5/2	27.5	10.0	19.0	16	1
55503203	20 x 1,5/1	28.2	10.0	24.0	20	1
55503204	25 x 1,5	33.8	12.0	29.0	25	1
55503205	32 x 1,5	38.0	13.0	38.0	32	1

SILVYN® LCCH-2

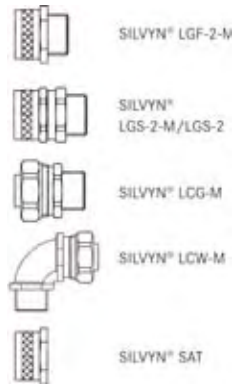

SILVYN® LCCH-2

Benefits

- Highly flame-retardant and self-extinguishing in accordance with UL94 V0
- Protection against liquids
- Highly compression proofed
- Highly flexible
- For higher mechanical stress

Application range

- Public utilities
- Mechanical engineering
- Outdoors application
- Everywhere where liquids are in the environment
- Applications with mechanical stress

Product features

- Halogen-free
- Less fumes
- Low toxicity

Approvals (Norm references)



- UNDERGROUND
- LLOYD'S REGISTER

Design

- Spirally wound metal protective conduit with roughened profile
- Plastic outer sheet

Technical data

- RAL** Colour delivered: RAL 9005 black
- Material**: Inner conduit: steel, galvanised; Outer sheath: plastic, halogen-free
- Range of temperature**: -25 °C up to +90 °C

Part number	Article designation	Internal Ø x External Ø in mm	Bending radius mm	Inner Ø in mm	PU ring in m
SILVYN® LCCH-2					
61804793	LCCH-2 / 12	10.2 x 14.0	30	10.2	25
61804794	LCCH-2 / 16	13.0 x 17.0	40	13.0	25
61804795	LCCH-2 / 20	16.9 x 21.5	45	16.9	25
61804796	LCCH-2 / 25	21.1 x 26.0	55	21.1	25
61804797	LCCH-2 / 32	28.1 x 34.0	70	28.1	25
61804798	LCCH-2 / 40	37.6 x 44.5	80	37.6	10
61804799	LCCH-2 / 50	48.4 x 55.0	90	48.4	10

Accessories

- SILVYN® LGF-2-M see page 138
- SILVYN® LGS-2-M see page 138
- SILVYN® LGS-2 see page 138
- SILVYN® LCG-M
- SILVYN® LCW-M
- SILVYN® SAT



Protective cable conduit systems liquid-tight

Protective cable conduit system SILVYN® LCC-2 / LCCH-2

SILVYN® LGF-2-M / SILVYN® LGS-2-M / SILVYN® LGS-2



SILVYN® LGF-2-M

SILVYN® LGS-2-M

SILVYN® LGS-2

Benefits

SILVYN® LGF-2-M

- For fixed applications
- High tensile strength
- Saving space

SILVYN® LGS-2-M

- For swivelable applications
- High tensile strength
- Saving space

SILVYN® LGS-2

- For swivelable applications
- High tensile strength
- Saving space

Application range

SILVYN® LGF-2-M

- In combination with protective conduit
- SILVYN® LCC-2
- SILVYN® LCCH-2
- Outdoors application
- Applications with mechanical stress

SILVYN® LGS-2-M

- In combination with protective conduit
- Protective cable conduit system SILVYN® LCC-2 / LCCH-2

- Outdoors application
- Applications with mechanical stress

SILVYN® LGS-2

- In combination with protective conduit
- Protective cable conduit system SILVYN® LCC-2 / LCCH-2
- Outdoors application
- Applications with mechanical stress

Approvals (Norm references)



Design

SILVYN® LGF-2-M

- Metrical connection thread
- Hexagonal collar
- Cap nut

SILVYN® LGS-2-M

- Metrical connection thread
- Hexagonal collar with swivel
- Cap nut

SILVYN® LGS-2

- PG connection thread
- Hexagonal collar with swivel
- Cap nut

Technical data

	Material Nickel-plated brass
	Degree of protection IP 54

Part number	Article designation	Overall length C mm	Thread length D mm	SW mm	Suitable for SILVYN® LCC-2/LCCH-1	Pieces / PU
SILVYN® LGF-2-M						
55501981	12 x 1,5	21.0	8.0	13.0	10	10
55502001	16 x 1,5/1	23.0	8.0	17.0	12	10
55502002	16 x 1,5/2	25.0	10.0	20.0	16	10
55502021	20 x 1,5/1	25.0	10.0	22.0	16	10
55502022	20 x 1,5/2	26.3	10.0	24.0	20	10
55502031	25 x 1,5	32.5	10.0	29.0	25	10
55502041	32 x 1,5	36.8	13.0	38.0	32	10
55502051	40 x 1,5	39.0	14.0	48.0	40	4
55502061	50 x 1,5	42.0	15.0	58.0	50	4
55502071	63 x 1,5	50.0	18.0	70.0	63	1
SILVYN® LGS-2-M						
55501982	12 x 1,5	30.2	8.0	13.0	10	10
55502003	16 x 1,5/1	32.2	8.0	17.0	12	10
55502004	16 x 1,5/2	34.2	10.0	20.0	16	10
55502023	20 x 1,5/1	34.2	10.0	22.0	16	10
55502024	20 x 1,5/2	35.5	10.0	24.0	20	10
55502032	25 x 1,5	43.7	10.0	29.0	25	10
55502042	32 x 1,5	48.0	13.0	38.0	32	10
55502052	40 x 1,5	51.2	14.0	48.0	40	4
55502062	50 x 1,5	54.2	15.0	58.0	50	4
55502072	63 x 1,5	63.2	18.0	70.0	63	1
SILVYN® LGS-2						
55502710	7	32.0	7.0	13.0	10	10
55502720	9	38.0	10.0	17.0	12	10
55502730	11	38.0	10.0	22.0	16	10
55502740	13,5	39.0	12.0	24.0	20	10
55502750	16	44.0	12.0	24.0	20	10
55502760	21	50.0	12.0	29.0	25	10
55502770	29	56.0	12.0	38.0	32	10
55502780	36	59.0	12.0	48.0	40	4
55502790	48	61.2	16.0	70.0	63	1

FLEXIMARK®

Cable marking products

The versatile marking systems for simple, permanent and clear marking of cables, components and system products. Even after many years, every marking must be clearly legible to fulfil its purpose and provide a good overview.

Markings in the wind energy sector need to meet stringent quality requirements. Confusing products or application areas due to illegible or detached markings can have fatal consequences. The FLEXIMARK® marking system provides permanent and robust marking options, which prevent problems of this kind and thus guarantee added safety.

Whether you choose plastic or stainless steel for harsh environments, manual or electronic marking – with FLEXIMARK® the result will always be a permanent marking.

Use our FLEXIMARK® software, the marking software for FLEXIMARK® labels, free of charge. This version is available for a 30 day trial and is fully featured – including CAD interfaces, barcode functions and easy configurable label sizes.



	BASIC SYSTEM	CUSTOMIZED SYSTEM
How?	Ready made to deliver for each environment	Your demand - we deliver
What?		
CABLE	Outdoor & Indoor MINI & MAXI & HOLDERS PTE STAINLESS STEEL COLLARS TS & HF & MARKING TAGS SHRINK TUBES COLLARS FOR CABLE TIES & MARKING TAGS	STAINLESS STEEL CABLE MARKING COLLARS FOR CABLE TIES & MARKING TAGS TEXT COLLARS PTET
	Indoor LABEL CARDS AND BLOCKS DYMO® printer	SHRINK TUBE MARKING CABLE TIE MARKING FKBB
WIRE	before mounting the wire FLEXIPART PA MARKING RINGS	SHRINK TUBE MARKING FLEXIPART MARKING RINGS
	after mounting the wire SNAP-ON COLLARS & MARKING TAGS PC MARKING RINGS	SNAP-ON COLLARS & MARKING TAGS
COMPONENT	Device marking MLM MOUNTING PROFILES & MINI PGS CHARACTER HOLDERS	ENGRAVED MARKING
	Terminal TERMINAL BLOCK DYMO® printer	TERMINAL BLOCK
	Sensor	MARKING FOR I/O BOXES

DATA MARKING

Laser office printer















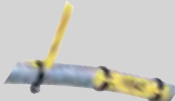













Flexisoft with ePLAN and WS-CAD interface



Thermal transfer printers



 <p>COLLARS FOR CABLE TIES LFL 4,2</p>		 <p>FLEXILABEL LFL & HOLDERS PTET/LAB</p>		 <p>FLEXILABEL TFL & HOLDERS PTEF/LAB</p>		 <p>COLLARS FOR CABLE TIES & MARKING TAGS TMB</p>	
 <p>LCK/LCFK LABELS</p>		 <p>CABLE LABEL LFL & TIES</p>		 <p>CABLELABEL LTFL & TIES</p>		 <p>TCK LABELS</p>	
 <p>TAG TIES & LA/LB LABELS</p>				 <p>FLEXIMARK® flat shrink tube</p>		 <p>TAG TIES & TA LABELS</p>	
 <p>FLEXIPRINT LF</p>		 <p>COLLARS TS/HF & FLEXILABEL LFL 4,2</p>		 <p>FLEXIPRINT TF</p>		 <p>SHRINKING TUBES SHRINK MARK SM</p>	
 <p>LCFK/LCK LABELS</p>				 <p>TCK LABELS</p>		 <p>SNAP-ON COLLARS & MARKING TAGS</p>	
 <p>LA LABELS</p>		 <p>LFL LEXEL/THORSMAN</p>		 <p>MLM MOUNTING PROFILES & LFL 9,5</p>		 <p>TA LABELS</p>	
				 <p>MLM MOUNTING PROFILES & TFL 9,5</p>			
 <p>LA LABELS</p>				 <p>TERMINAL BLOCK</p>			
 <p>CLIP-ON COLLARS & LFL</p>				 <p>CLIP-ON COLLARS & MARKING TAGS</p>			



APPENDIX

Whether you are an engineer, planner, buyer or service technician, it's always worth getting expert advice from Lapp. After all, knowledge is power!

And we can provide you with this knowledge. Whether you want to compare technical data or create a product with certain properties. Our expertise and vast range of information gives you a reliable help or a solid basis for solving your particular task.

Selection Tables

Technical Tables

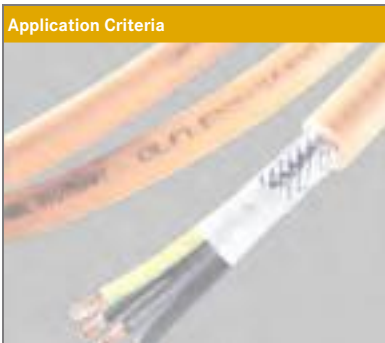
Application Criteria	Cable and Lead Designation																																	
	ÖLFLEX® CLASSIC 100 H	ÖLFLEX® CLASSIC 110 H	ÖLFLEX® CLASSIC 110 CH	ÖLFLEX® 120 H	ÖLFLEX® 120 CH	ÖLFLEX® CLASSIC 130 H	ÖLFLEX® CLASSIC 135 CH	ÖLFLEX® 440 P	ÖLFLEX® 440 CP	ÖLFLEX® 540 P	ÖLFLEX® 540 CP	ÖLFLEX® SERVO FD 755 P	ÖLFLEX® SERVO FD 755 CP	ÖLFLEX® SERVO FD 760 CP	ÖLFLEX® SERVO FD 770 CP	ÖLFLEX® SERVO FD 781 P	ÖLFLEX® SERVO FD 781 CP	ÖLFLEX® SERVO FD 785 P	ÖLFLEX® SERVO FD 785 CP	ÖLFLEX® FD 820 H	ÖLFLEX® FD 820 CH	ÖLFLEX® FD 855 P	ÖLFLEX® FD 855 CP	ÖLFLEX® HEAT 145 SC	ÖLFLEX® HEAT 145 MC	ÖLFLEX® HEAT 145 C MC	ÖLFLEX® HEAT 180 single cores	ÖLFLEX® HEAT 180 SIHF	ÖLFLEX® HEAT 180 HO5SS-F	HO5Z-K halogen free single core	ÖLFLEX® PETRO 125P plus/BP plus			
Application																																		
Machinery and industrial installation:																																		
- External cabling of machinery	●	●	●	●	●	●	●	●	●	●	●	●	●	●	●	●	●	●	●	●	●	●	●	●	●	●	●	●	●	●	●	●	●	
- Internal cabling in cabinets	●	●	●	●	●	●	●	●	●	●	●	●	●	●	●	●	●	●	●	●	●	●	●	●	●	●	●	●	●	●	●	●	●	
Other circuits in buildings:																																		
- Lightning circuits	○																																	
- Power circuits	○																																	
- Data network cables																																		
Standards																																		
Halogen free to VDE 0482 T 267	●	●	●	●	●	●	●	●	●	●	●	●	●	●	●	●	●	●	●	●	●	●	●	●	●	●	●	●	●	●	●	●	●	
Low smoke density	●	●	●	●	●	●	●	●	●	●	●	●	●	●	●	●	●	●	●	●	●	●	●	●	●	●	●	●	●	●	●	●	●	
Low toxicity of the smoke	●	●	●	●	●	●	●	●	●	●	●	●	●	●	●	●	●	●	●	●	●	●	●	●	●	●	●	●	●	●	●	●	●	
Flame retardant to IEC 60 332.1-2	●	●	●	●	●	●	●	●	●	●	●	●	●	●	●	●	●	●	●	●	●	●	●	●	●	●	●	●	●	●	●	●	●	
High ignition temperature to IEC 60 332.3	●	●	●	●	●	●	●	●	●	●	●	●	●	●	●	●	●	●	●	●	●	●	●	●	●	●	●	●	●	●	●	●	●	
Based on VDE/HAR/DIN/UL	●	●	●	●	●	●	●	●	●	●	●	●	●	●	●	●	●	●	●	●	●	●	●	●	●	●	●	●	●	●	●	●	●	
With approval VDE/HAR/DIN/UL/TÜV								●	●	●	●																							
Temperature range																																		
+180 °C																																		
+145 °C																																		
+120 °C																																		
+110 °C																																		
+90 °C																																		
+80 °C	□	□	□																															
+70 °C	■	■	■	■	■	■	■																											
0 °C																																		
-5 °C																																		
-15 °C																																		
-25 °C																																		
-30 °C	■	■	■	■	■	■	■																											
-40 °C	□	□	□	□	□	□	□																											
-50 °C																																		
-60 °C																																		
Nominal voltage																																		
250 Vss																																		
300/500 V	●	●	●	●	●	●	●	●	●	●	●	●	●	●	●	●	●	●	●	●	●	●	●	●	●	●	●	●	●	●	●	●	●	
450/750 V	○																																	
600/1000 V	○																																	
1.8/3 KV																																		
3.6/6 KV																																		
Make-up																																		
Solid wire VDE 0295 class 1																																		
Multi wire VDE 0295 class 2																																		
Fine wire VDE 0295 class 5	●	●	●	●	●	●	●	●	●	●	●	●	●	●	●	●	●	●	●	●	●	●	●	●	●	●	●	●	●	●	●	●	●	
Superfine wire VDE 0295 class 6																																		
Number printing VDE 0293	●	●	●	●	●	●	●	●	●	●	●	●	●	●	●	●	●	●	●	●	●	●	●	●	●	●	●	●	●	●	●	●	●	
Colour code to VDE 0293-308, HD308 S2	●																																	
Colour code to DIN 47100																																		
Colour code for indoor telephone cables																																		
Special colour code																																		
Individual colours																																		

Further halogen free cables and leads on request.

- = Principal application
- = Application not customary, but possible, or alternative design available in the range
- = Temperature range for flexible laying
- ▣ = Temperature range for static and flexible laying
- = Temperature range for static laying

Halogen free accessories:

Protective conduits

- SILVYN® RILL PA6
- SILVYN® RILL PA12
- SILVYN® FPAS
- SILVYN® HCC
- SILVYN® RILL LCCH-2
- SILVYN® AS
- SILVYN® EDU-AS
- SILVYN® EMC AS-CU
- SILVYN® SSUE
- SILVYN® UI 511
- SILVYN® HFX
- SILVYN® CHAIN NYLON
- SILVYN® CHAIN STEEL

Cable Marking

- FLEXIMARK® single core marking
- Flexipart, Marking collar, Flexiprint
- FLEXIMARK® cable marking
- System MINI, shrink tube marking
- FLEXIMARK® Component marking
- Engraved markers BMK, LB labels
- DYMO® label strips

Accessories

- Metal plates, Conductor end sleeves insulated
- Insulated cable lugs, Insulating tape TBTA
- Shrink tubing CMP/PKG/HSB/PLG
- TEC sealing cap
- TEB branch muff
- KW plastic coil
- Cable ties Basic Tie/TY-RAP®/TY-FAST®

Selection Table

A4: Halogen free Cables and Leads

Application Criteria	Cable and Lead Designation																												
	ÖLFLEX® TRAFFIC 3GKW/3GKW flex/3GKW C-flex	ÖLFLEX® TRAFFIC 4GKW-Axplus/C-flex	ÖLFLEX® SOLAR XL S	ÖLFLEX® SOLAR XL multi	ÖLFLEX® HEAT 180 EWKF	ÖLFLEX® HEAT 180 UL/CSA	ÖLFLEX® HEAT 180 EWKF C	ÖLFLEX® HEAT 180 GLS	NSHXAFÖ	ÖLFLEX® SPIRAL 540 P	Halogen free single core	UNITRONIC® BUS L2/FIP 7-wire	UNITRONIC® LHCH	UNITRONIC® LHCH (TP)	UNITRONIC® BUS EIB	UNITRONIC® BUS P Combi IBS	UNITRONIC® BUS FD P IBS	UNITRONIC® BUS FD P-LD	UNITRONIC® BUS AS-INTERFACE	ETHERLINE® H	LAN UTP-H CAT.5+6 halogen free	LAN FTP-H CAT.5+6 halogen free	LAN S-FTP-H CAT.5+6 halogen free	LAN STP-H CAT.6 halogen free	(N)HXMH	UNITRONIC® FD P plus UL/CSA	UNITRONIC® FD CP plus UL/CSA	H05Z-K, H07Z-K 90 °C	H05Z-K, H07Z-K 110 °C
Application																													
Machinery and industrial installation:																													
- External cabling of machinery	●	●	●	●	●	●	●	●	●	●	●	●	●	●	●	●	●	●	●	●	●	●	●	●	●	●	●	●	
- Internal cabling in cabinets																													
Other circuits in buildings:																													
- Lightning circuits																													
- Power circuits																													
- Data network cables																													
Standards																													
Halogen free to VDE 0482 T 267	●	●	●	●	●	●	●	●	●	●	●	●	●	●	●	●	●	●	●	●	●	●	●	●	●	●	●	●	
Low smoke density	●	●	●	●	●	●	●	●	●	●	●	●	●	●	●	●	●	●	●	●	●	●	●	●	●	●	●	●	
Low toxicity of the smoke	●	●	●	●	●	●	●	●	●	●	●	●	●	●	●	●	●	●	●	●	●	●	●	●	●	●	●	●	
Flame retardant to IEC 60 332.1-2	●	●	●	●	●	●	●	●	●	●	●	●	●	●	●	●	●	●	●	●	●	●	●	●	●	●	●	●	
Flame retardant to IEC 60 332.3	●	●																											
Based on VDE/HAR/DIN/UL																													
With approval VDE/HAR/DIN/UL/TÜV				●	●						○					○	○	○	○										
Temperature range																													
+180 °C					■	■	■	■																					
+145 °C																													
+120 °C	□	□		■																									
+110 °C											□																	□	
+90 °C	■	■	■						■	■																		□	
+80 °C												□	□																
+70 °C																													
0 °C										■																			
-5 °C																													
-15 °C																												□	
-25 °C																													
-30 °C	■	■																											
-40 °C	□		■	■							□	■	□	□														□	
-50 °C																													
-60 °C		□																											
Nominal voltage																													
250 Vss																													
300/500 V																													
450/750 V																													
600/1000 V	●																												
1.8/3 KV		●																											
3.6/6 KV																													
Make-up																													
Solid wire VDE 0295 class 1																													
Multi wire VDE 0295 class 2																													
Fine wire VDE 0295 class 5	●	●	●	●	●	●	●	●	●	●	●	●	●	●	●	●	●	●	●	●	●	●	●	●	●	●	●	●	
Superfine wire VDE 0295 class 6																													
Number printing VDE 0293	●	●																											
Colour code to VDE 0293-308, HD308 S2																													
Colour code to DIN 47100																													
Colour code for indoor telephone cables																													
Special colour code																													
Individual colours			●	●						●	●																		

Further halogen free cables and leads on request.

- = Principal application
- = Application not customary, but possible, or alternative design available in the range
- = Temperature range for flexible laying
- = Temperature range for static and flexible laying
- = Temperature range for static laying

Halogen free accessories:

Protective conduits

- SILVYN® RILL PA6
- SILVYN® RILL PA12
- SILVYN® FPAS
- SILVYN® HCC
- SILVYN® RILL LCCH-2
- SILVYN® AS
- SILVYN® EDU-AS
- SILVYN® EMC AS-CU
- SILVYN® SSUE
- SILVYN® UI 511
- SILVYN® HFX
- SILVYN® CHAIN NYLON
- SILVYN® CHAIN STEEL

Cable Marking

- FLEXIMARK® single core marking
- Flexipart, Marking collar, Flexiprint
- FLEXIMARK® cable marking
- System MINI, shrink tube marking
- FLEXIMARK® Component marking
- Engraved markers BMK, LB labels
- DYMO® label strips

Accessories

- Metal plates, Conductor end sleeves insulated
- Insulated cable lugs, Insulating tape TBTA
- Shrink tubing CMP/PKG/HSB/PLG
- TEC sealing cap
- TEB branch muff
- KW plastic coil
- Cable ties Basic Tie/TY-RAP®/TY-FAST®

Selection Table

A5: Data transmission cables for low-frequency analog/digital transmissions

Application Criteria	Cable and Lead Designation																												
	UNITRONIC® LiYY	UNITRONIC® LiYCY	UNITRONIC® LiYY (TP)	UNITRONIC® LiYCY (TP)	UNITRONIC® PUR CP	UNITRONIC® PUR CP (TP)	UNITRONIC® LiHH	UNITRONIC® LiHCH	UNITRONIC® LiHCH (TP)	UNITRONIC® 100	UNITRONIC® 100 CY	UNITRONIC® LiYCY-CY	UNITRONIC® LiFYCY (TP)	UNITRONIC® CY PIDY (TP)	UNITRONIC® LiYD 11Y	UNITRONIC® ST	UNITRONIC® FD	UNITRONIC® FD CY	UNITRONIC® FD P plus UL/CSA	UNITRONIC® FD CP plus UL/CSA	UNITRONIC® FD CP (TP) plus UL/CSA	UNITRONIC® Li2YCY (TP)-Li2YCYv (TP)	UNITRONIC® Li2YCY PIMF	JE-Y (ST)Y	JE-LiYCY (TP)	Telephone indoor cable J-YY / J-Y (ST)Y	Fire alarm cable J-Y (ST)Y red	UNITRONIC® J-2Y (ST)Y	Telephone outdoor cable
Application																													
Additional control/time recording systems (ZK/ZE)																													
Operating data acquisition (BDE)																													
Clock systems																													
Forced entry alarm systems (EMA)																													
Fire alarm systems (BMA)																													
Telephone extension systems																													
Interphone/Duplex systems																													
Electroacoustic systems (ELA/PA)																													
Sound studio cable/microphone cable																													
Printer/Plotter																													
Direct current stepping motors																													
Encoder																													
Industrial sensors, U < 50 Veff																													
Industrial actuators, U < 50 Veff																													
Measurement and control system, analog (MSR)																													
MSR, digital																													
In electronic instruments																													
For cutting/clipping technology (0.34 mm ² /AWG 22)																													
Temperature range																													
+80 °C																													
+70 °C																													
+60 °C																													
-5 °C																													
-20 °C																													
-30 °C																													
-40 °C																													
Laying																													
For static laying outdoors																													
For direct laying underground																													
For static installation (indoors)																													
For flexible laying (indoors) occasionally																													
For continuous flexible laying (indoors/outdoors)																													
Make-up																													
Halogen free																													
Flame retardant, self extinguishing																													
For electr. symmetrical signal transmission (TP), twisted pair																													
For high end coupling of the pairs, screened																													
For electrical screening effect, total screening																													
For low attenuation transmission, low capacitance																													
With individually screened cores																													
With combined core pairs/individual conductors																													
With colour code DIN 47100																													
With UNITRONIC® colour code																													
With industrial electronics colour code VDE 0815																													
With star-quad colour code "BD" to VDE 0815/0816																													
With pair colour code "LG" to VDE 0815																													
With special colour code																													
With numbered cores																													
With PVC/special PVC outer sheath																													
With PUR sheath, wear resistant, cutting resistant																													
With PE outer sheath (not flame-retardant)																													

Further halogen free cables and leads on request.

- = Principal application
- = Application not customary, but possible, or alternative design available in the range
- = Temperature range for flexible laying
- ▣ = Temperature range for static and flexible laying
- = Temperature range for static laying

Halogen free accessories:

Protective conduits

- SILVYN® RILL PA6
- SILVYN® RILL PA12
- SILVYN® FPAS
- SILVYN® HCC
- SILVYN® RILL LCCH-2
- SILVYN® AS
- SILVYN® EDU-AS
- SILVYN® EMC AS-CU
- SILVYN® SSUE
- SILVYN® UI 511
- SILVYN® HFX
- SILVYN® CHAIN NYLON
- SILVYN® CHAIN STEEL

Cable Marking

- FLEXIMARK® single core marking
- Flexipart, Marking collar, Flexiprint
- FLEXIMARK® cable marking
- System MINI, shrink tube marking
- FLEXIMARK® Component marking
- Engraved markers BMK, LB labels
- DYMO® label strips

Accessories

- Metal plates, Conductor end sleeves insulated
- Insulated cable lugs, Insulating tape TBTA
- Shrink tubing CMP/PKG/HSB/PLG
- TEC sealing cap
- TEB branch muff
- KW plastic coil
- Cable ties Basic Tie/TY-RAP®/TY-FAST®

A7: UNITRONIC® BUS and ETHERLINE® – Which UNITRONIC® BUS cable for which field bus system?

Cable and Lead Designation	Application Criteria																						
	Laying	stationary static	flexible	highly flexible (power chains etc.)	outdoor use/direct burial/UV-resist.	Standards	UL/CSA approved	Characteristic impedance	100 – 120 Ohm	Bus systems	INTERBUS® DIN 19258 EN 50251 Sensor-/Actor Bus	INTERBUS® (Phoenix Contact)	SUCOnet p® (Klöckner-Möller) Modulink® P (Weidmüller) VariNet®-P (Pepperl + Fuchs)	PROFIBUS DIN 19245 EN 50170	PROFIBUS-DP, -FMS/FIP	PROFIBUS-PA, Foundation™ Fieldbus	CAN ISO 11898	AS-INTERFACE	EIB	CC-Link	DeviceNet™ (Allen-Bradley/Rockwell Automation)	Industrial Ethernet/Fast Ethernet	
Lapp Kabel Bus Cables (cross sections in mm ² or diameter in mm or AWG size)																							
UNITRONIC® BUS IBS + UNITRONIC® BUS IBS UL/CSA 3 x 2 x 0.22 + 3 x 1.0	•											•											
UNITRONIC® BUS P COMBI IBS 3 x 2 x 0.22 + 3 x 1.0	•											•											
UNITRONIC® BUS FD P IBS 3 x 2 x 0.25				•								•											
UNITRONIC® BUS FDP COMBI IBS 3 x 2 x 0.25 + 3 x 1.0				•								•											
UNITRONIC® BUS Yv COMBI IBS 3 x 2 x 0.22 + 3 x 2 x 0.22 + 3 x 1.0					•							•											
UNITRONIC® BUS LD, FD P LD 1 x 2 x 0.22, 2 x 2 x 0.22 + 3 x 2 x 0.22	•		•					•					•										
UNITRONIC® BUS L2/FIP, C2/FIP/UL/CSA 1 x 2 x 0.64	•														•								
UNITRONIC® BUS L2/FIP PE 1 x 2 x 0.64	•														•								
UNITRONIC® BUS L2/FIP 7-wire, halogen free 1 x 2 x 0.64	•	•													•								
UNITRONIC® BUS PA (BU)+(BK) 1 x 2 x 1.0	•														•								
UNITRONIC® BUS FD P L2/FIP 1 x 2 x 0.64				•											•								
UNITRONIC® FD P COMBI L2/FIP 1 x 2 x 0.64 + 3 x 1.0				•											•								
UNITRONIC® BUS L2/FIP Torsion UL/CSA 1 x 2 x 0.8				•											•								
UNITRONIC® BUS L2/FIP Festoon UL/CSA 1 x 2 x 0.64				•											•								
UNITRONIC® FD P PROFIBUS HYBRID 1 x 2 x 0.64 + 4 x 1.5				•											•								
UNITRONIC® BUS Yv L2/FIP, YY C2/FIP 1 x 2 x 0.64					•										•								
UNITRONIC® BUS L2/FIP FC, ...PE FC 1 x 2 x 0.64	•														•								
UNITRONIC® BUS L2/FIP-H FC UL/CSA 1 x 2 x 0.64	•														•								
UNITRONIC® BUS L2/FIP PUR FC UL/CSA 1 x 2 x 0.64	•														•								
UNITRONIC® BUS PA FC (BU) UL/CSA + (BU+BK) 1 x 2 x 1.0	•														•	•							
UNITRONIC® BUS FD P L2/FIP FC UL/CSA 1 x 2 x 0.64				•											•								
UNITRONIC® BUS L2/FIP BURIAL FC 1 x 2 x 0.64					•										•								
UNITRONIC® BUS CAN UL/CSA 1 x 2 x 0.22, 2 x 2 x 0.22	•																•						
UNITRONIC® BUS CAN UL/CSA 1 x 2 x 0.34, 2 x 2 x 0.34	•																•						
UNITRONIC® BUS CAN UL/CSA 1 x 2 x 0.5, 2 x 2 x 0.5	•																•						
UNITRONIC® BUS CAN UL/CSA 1 x 2 x 0.75, 2 x 2 x 0.75	•																•						
UNITRONIC® BUS FD P CAN UL/CSA 1 x 2 x 0.22, 2 x 2 x 0.22				•													•						
UNITRONIC® BUS FD P CAN UL/CSA 1 x 2 x 0.34, 2 x 2 x 0.34				•													•						

Legend

- 7-wire = 7-wire strand
- AS-I = AS-INTERFACE
- BK = black outer sheath
- COMBI IBS = Installation remote bus cable for INTERBUS
- FD = suitable for power chains
- FIP = Factory Instrumentation Protocol
- G = rubber outer sheath (EPDM)

- H = Halogen free material
- IBS = Remote bus cable for INTERBUS
- L2 = Abbreviation for SINEC® L2-DP
- LD = Low attenuation
- P = Polyurethane outer sheath
- PE = Polyethylene outer sheath
- PROFIBUS-DP = Decentralized Periphery

- PROFIBUS-FMS = Fieldbus Message Specification
- PROFIBUS-PA = Process Automation
- TPE = thermoplastic Elastomer
- YE = yellow outer sheath
- Yv = Wire for outdoor use/direct burial with reinforced PVC outer sheath

- CC-Link® = is a registered trademark of CLPA, Japan
- DeviceNet™ = is a registered trademark of Open Device Vendors Association (ODVA)
- Foundation™ = is a registered trademark of Foundation Fieldbus
- INTERBUS® = is a registered trademark of Phoenix Contact GmbH & Co.
- Modulink® P = is a registered trademark of Weidmüller GmbH & Co.

- SIMATIC® = is a registered trademark of SIEMENS AG
- SINEC® = is a registered trademark of SIEMENS AG
- SUCOnet P® = is a registered trademark of der Klöckner + Moeller GmbH
- VariNet®-P = is a registered trademark of Pepperl + Fuchs GmbH



Selection Table

A7: UNITRONIC® BUS and ETHERLINE® – Which UNITRONIC® BUS cable for which field bus system?

Cable and Lead Designation	Application Criteria																									
	Laying	stationary	flexible	highly flexible (power chains etc.)	outdoor use/direct burial/UV-resist.	Standards	Characteristic impedance	100 – 120 Ohm	Bus systems	INTERBUS® DIN 19258 EN 50251	Sensor-/Actor Bus	INTERBUS® (Phoenix Contact)	SUCOnet P® (Klöckner-Möller)	Modulink® P (Weidmüller)	VariNet®-P (Pepperl + Fuchs)	PROFIBUS DIN 19245 EN 50170	PROFIBUS-DP, -FMS/FIP	PROFIBUS-PA, Foundation™ Fieldbus	CAN ISO 11898	AS-INTERFACE	EIB	CC-Link	DeviceNet™ (Allen-Bradley/Rockwell Automation)	Industrial Ethernet/Fast Ethernet		
Lapp Kabel Bus Cables (cross sections in mm² or diameter in mm or AWG size)																										
UNITRONIC® BUS FD P CAN UL/CSAO 1 x 2 x 0.5, 2 x 2 x 0.5				•																						
UNITRONIC® BUS ASI (G) YE + BK 2 x 1.5	•																									
UNITRONIC® BUS ASI (TPE) UL/CSA YE + BK 2 x 1.5	•																									
UNITRONIC® BUS ASI (PUR) YE + BK 2 x 1.5	•																									
UNITRONIC® BUS ASI (PUR) MARINE YE + BK 2 x 1.5	•																									
UNITRONIC® BUS ASI (PVC) UL/CSA CMG YE + BK 2 x 1.5	•																									
UNITRONIC® DeviceNet THICK (halogen free) AWG 18 + 15	•																									
UNITRONIC® DeviceNet THIN (halogen free) AWG 24 + 22	•																									
UNITRONIC® DeviceNet THICK (PVC) AWG 18 + 15	•																									
UNITRONIC® DeviceNet THIN (PVC) AWG 24 + 22	•																									
UNITRONIC® FD P DeviceNet THICK (PUR) AWG 18 + 15				•																						
UNITRONIC® FD P DeviceNet THIN (PUR) AWG 24 + 22				•																						
UNITRONIC® FD P DeviceNet THICK (PVC) AWG 18 + 15				•																						
UNITRONIC® FD P DeviceNet THIN (PVC) AWG 24 + 22				•																						
UNITRONIC® BUS EIB, ...EIB halogen free 2 x 2 x 0.8	•																									
UNITRONIC® BUS COMBI EIB, ...halogen free 2 x 2 x 0.8 + 3 x 1.5	•																									
ETHERLINE®-H, P 2 x 2 x AWG 24/1 and 4 x 2 x AWG 24/1	•																									
ETHERLINE®-H-H 4 x 2 x AWG 24/1	•																									
ETHERLINE®-H FLEX, P-FLEX 2 x 2 x AWG 26/7 and 4 x 2 x AWG 26/7	•																									
ETHERLINE®-Y FC CAT.5e, YY CAT.5e, UL/CSA CAT.5e 2 x 2 x AWG 22/1	•																									
ETHERLINE®-FD P CAT.5 2 x 2 x AWG 26/19, 4 x 2 x AWG 26/19	•																									
ETHERLINE®-FD P FC UL/CSA CAT.5e 2 x 2 x AWG 22/7	•																									
UNITRONIC® BUS FF 3, FF ARM 1 x 2 x 1.1 + 1 x 1.1	•																									
UNITRONIC® BUS FF 2 1 x 2 x 1.1	•																									
UNITRONIC® BUS CCL 3 x 1 x AWG 20	•																									
ETHERLINE® Y FLEX FC UL/CSA (CMG) 2 x 2 x AWG 22/7	•																									
ETHERLINE® YZY ARM Type A CAT.5e 2 x 2 x AWG 22/1	•																									
ETHERLINE® FRNC HYBRID FLEX FC UL (AWM)	•																									
ETHERLINE® Y PiMF CAT.6e, P PiMF, H PiMF 4 x 2 x AWG 22/1	•																									
ETHERLINE® Y PiMF CAT.7, P PiMF, H PiMF 4 x 2 x AWG 22/1	•																									

Legend

- | | | |
|--|---------------------------------------|--|
| 7-wire = 7-wire strand | H = Halogen free material | PROFIBUS-FMS = Fieldbus Message Specification |
| AS-I = AS-INTERFACE | IBS = Remote bus cable for INTERBUS | PROFIBUS-PA = Process Automation |
| BK = black outer sheath | L2 = Abbreviation for SINEC® L2-DP | TPE = thermoplastic Elastomer |
| COMBI IBS = Installation remote bus cable for INTERBUS | LD = Low attenuation | YE = yellow outer sheath |
| FD = suitable for power chains | P = Polyurethane outer sheath | Yv = Wire for outdoor use/direct burial with reinforced PVC outer sheath |
| FIP = Factory Instrumentation Protocol | PE = Polyethylene outer sheath | |
| G = rubber outer sheath (EPDM) | PROFIBUS-DP = Decentralized Periphery | |

CC-Link® = is a registered trademark of CLPA, Japan
 DeviceNet™ = is a registered trademark of Open Device Vendors Association (ODVA)
 Foundation™ = is a registered trademark of Foundation Fieldbus
 INTERBUS® = is a registered trademark of Phoenix Contact GmbH & Co.
 Modulink® P = is a registered trademark of Weidmüller GmbH & Co.
 SIMATIC® = is a registered trademark of SIEMENS AG
 SINEC® = is a registered trademark of SIEMENS AG
 SUCOnet P® = is a registered trademark of der Klöckner + Moeller GmbH
 VariNet®-P = is a registered trademark of Pepperl + Fuchs GmbH

A7: UNITRONIC® BUS and ETHERLINE® – Technical Data

Cable Designation	Parameters								
	Characteristic impedance Ω	Mutual capacitance (800 Hz) max. nF/km	Peak working voltage in V (not for power purpose)	Test voltage conductor / conductor Urms, V	Conductor resistance max. Ω/km (Data Pair)	Minimum bending radius static in mm	Minimum bending radius flexible in mm	Temperature range °C static	Temperature range °C flexible
 UNITRONIC® BUS IBS static laying	100	60	250	1500	186	8 x D	-	-40 °C up to +80 °C	-
UNITRONIC® BUS FD P IBS highly flexible application	100	60	250	1500	159.8	-	15 x D	-	-30 °C up to +70 °C
UNITRONIC® BUS Yv IBS outdoor use / direct burial	100	60	250	1500	186	8 x D	-	-40 °C up to +80 °C	-
UNITRONIC® BUS LD static laying	100 – 120	60	250	1500	186	8 x D	-	-40 °C up to +80 °C	-
UNITRONIC® BUS FD P LD highly flexible application	100 – 120	60	250	1500	159.8	-	15 x D	-	-30 °C up to +70 °C
UNITRONIC® BUS L2 /FIP static laying	150+/-15	30	250	1500	110	75 mm	-	-40 °C up to +70 °C	-
UNITRONIC® BUS FD P L2 /FIP highly flexible application	150+/-15	30	250	1500	133	-	w/o FC = 65 mm FC = 120 mm	-	-30 °C up to +70 °C
UNITRONIC® BUS Yv L2 /FIP outdoor use / direct burial	150+/-15	30	250	1500	110	100 mm	-	-40 °C up to +70 °C	-
UNITRONIC® BUS PA (blue + black), static laying	100+/-20	-	250	1500	44	70 mm	-	-30 °C up to +70 °C	-
UNITRONIC® BUS CAN UL /CSA static laying (0.22 mm ²)	100 – 120	40	250	1500	186	8 x D	-	-40 °C up to +80 °C	-
UNITRONIC® BUS FD P CAN, UL /CSA highly flexible application (0.25 mm ²)	100 – 120	40	250	1500	159.8	-	15 x D	-	-30 °C up to +70 °C
UNITRONIC® BUS FF static laying	100	56	300	1500	≤ 24	15 x D	-	-25 °C up to +80 °C	-
UNITRONIC® BUS CCL static laying	110	60	300	2000	37.8	15 x D	-	-40 °C up to +70 °C	-
UNITRONIC® Etherline®-H CAT.5 2 pairs	100	48	125	1000	192	42 mm	-	-30 °C up to +80 °C	-5 °C up to +60 °C
UNITRONIC® Etherline®-P CAT.5 2 pairs	100	46	125	1000	186.6	42 mm	-	-30 °C up to +80 °C	-5 °C up to +60 °C
UNITRONIC® Etherline®-H-H 2 pairs	100	46	125	1000	186.6	60 mm	-	-30 °C up to +80 °C	-5 °C up to +60 °C
UNITRONIC® Etherline®-H FLEX 2 pairs	100	48	125	1000	284	30 mm	78 mm	-30 °C up to +80 °C	-5 °C up to +60 °C
ETHERLINE® P FLEX 2 pairs	100	48	125	1000	284	30 mm	78 mm	-30 °C up to +80 °C	-5 °C up to +60 °C
ETHERLINE®-H CAT.5 4 pairs	100	48	125	1000	192	50 mm	-	-30 °C up to +80 °C	-5 °C up to +60 °C
ETHERLINE®-P CAT.5 4 pairs	100	46	125	1000	186.6	50 mm	-	-30 °C up to +80 °C	-5 °C up to +60 °C
ETHERLINE®-H-H 4 pairs	100	46	125	1000	186.6	55 mm	-	-30 °C up to +80 °C	-5 °C up to +60 °C
ETHERLINE®-H FLEX 4 pairs	100	48	125	1000	284	35 mm	90 mm	-30 °C up to +80 °C	-5 °C up to +60 °C
ETHERLINE®-P FLEX 4 pairs	100	48	125	1000	284	35 mm	90 mm	-30 °C up to +80 °C	-5 °C up to +60 °C
ETHERLINE®Y CAT.5e AWG 22 /1 static laying	100	48	125	1000	192	-	78 mm	-30 °C up to +80 °C	-5 °C up to +60 °C
ETHERLINE®Y UL /CSA CAT.5e AWG 22 /1 static laying	100	48	125	1000	192	-	90 mm	-30 °C up to +70 °C	-5 °C up to +60 °C



Selection Table

A8: Screw Type Cable Glands - At a glance

	Characteristics													Approvals	
	Protection class IP	Connection thread metric	Connection thread PG	Connection thread NPT	for round cables	for flat cables	Metal	Plastic	Angle	Strain relief	Vibration protection	Antikink protection	Screen connection		Use for hazardous areas
Cable glands															
SKINTOP® ST-M / STR-M / ST(R) M ISO	68/69K	●			●			●		●	●				cULus, cURus, TÜV, VDE, DNV
SKINTOP® CLICK / CLICK-R	68				●			●		●	●				VDE
SKINTOP® CLICK BS	68				●		●			●	●	●			VDE
SKINTOP® ST and STR	68		●		●			●		●	●				UL, UR, CSA, TÜV
SKINTOP® ST (NPT) and STR (NPT)	68			●	●			●		●	●				UL, UR, CSA
SKINTOP® ST-HF-M	68	●			●			●		●	●				VDE
SKINTOP® BS-M / BS M ISO	68	●			●			●		●	●	●			cULus, cURus, VDE, DNV
SKINTOP® BS	68		●		●			●		●	●	●			UL, UR, CSA
SKINTOP® BS (NPT)	68			●	●			●		●	●	●			
SKINTOP® BT and BT-M	68	●	●		●			●		●	●	●			
SKINTOP® MS-M and MSR-M/MS-M-XL and MSR-M-XL	68/69K	●			●		●			●					cULus, cURus, VDE, DNV
SKINTOP® MS and MSR	68		●		●		●			●					
SKINTOP® MS (NPT) and MSR (NPT)	68			●	●		●			●					UL, UR, CSA
SKINTOP® MS-IS-M	68	●			●		●			●					
SKINTOP® MS-SC-M	68	●			●		●			●			●		cULus, cURus, DNV
SKINTOP® MS-SC-M BRUSH / BRUSH plus	68	●			●		●			●			●		
SKINTOP® MS-SC	68		●		●		●			●			●		
SKINTOP® K-M ATEX	64/68	●			●			●		●	●			●	DNV, ATEX
SKINTOP® KR-M ATEX	64/68	●			●			●		●	●			●	DNV, ATEX
SKINTOP® MS-M ATEX / MS-M-XL ATEX	68	●			●		●			●				●	cULus, cURus, DNV, ATEX
SKINTOP® MSR-M ATEX	68	●			●		●			●				●	cULus, cURus, DNV, ATEX
SKINDICHT® MINI	68	●			●		●								
SKINDICHT® CN and CN-M	68	●	●		●		●								
SKINDICHT® SHV-M	68	●			●		●								
SKINDICHT® SHV	68		●		●		●								
SKINDICHT® SHV-M-Viton®	68	●			●		●								
SKINDICHT® SHV-Viton®	68		●		●		●								
SKINDICHT® SHVE-M	68	●			●		●						●		
SKINDICHT® SHVE	68		●		●		●						●		
SKINDICHT® SR-SV-M	65	●			●		●			●					
SKINDICHT® SR-SV	65		●		●		●			●			●		
SKINDICHT® FL	65				●		●								
SKINDICHT® SRE-M	65	●			●		●			●			●		
SKINDICHT® SRE	65		●		●		●			●			●		
SKINDICHT® SR-M	65	●			●		●			●			●		
SKINDICHT® SR	65		●		●		●			●			●		
SKINDICHT® KW-M	55	●			●		●	●	●						
SKINDICHT® SE and SE-M	55	●	●		●		●		●						
SKINDICHT® SE 216/316 and SE-M 220/320	55	●	●		●		●		●						
SKINDICHT® RWV-M	55	●			●		●		●						
SKINDICHT® RWV	55		●		●		●		●						
SKINDICHT® SKZ-M	55	●			●		●			●					
SKINDICHT® SKZ	55		●		●		●			●					
SKINDICHT® SHZ-M	55	●			●		●			●					
SKINDICHT® SHZ	55		●		●		●			●					
SKINDICHT® SVF and SVF-M	54	●	●		●	●	●								
SKINDICHT® SVFK	54		●		●		●	●							
SKINDICHT® SVRE-M	54	●			●		●								
SKINDICHT® SVRE	54		●		●		●								
SKINDICHT® SVRN-M	54	●			●		●								
SKINDICHT® SVRN	54		●		●		●								
SKINDICHT® SVRX-W	54	●			●		●								
SKINDICHT® SVRX-Z	54	●			●		●						●		
SKINDICHT® SK	20		●		●		●			●					
SKINDICHT® SH	20		●		●		●			●					

VITON® is a registered trademark of DuPont de Nemour

A11: Applications of HITRONIC® fibre optic components – At a glance

Cable Designation	Application											
	UL approved	Highly flexible	Heat resistant	Limited UV resistant	Heavy duty	Halogen free	Energy and data transmission	INTERBUS	PROFIBUS	Bidirectional data transmission systems	Unidirectional data transmission systems	SERCOS interface
Lapp Kabel-HITRONIC®-fibre optic (POF) program – fibre type, part number												
HITRONIC® POF SIMPLEX PE-PUR POF 980/1000, Part No. 2185 030				•		•					•	
HITRONIC® POF SIMPLEX PVC UL POF 980/1000, Part No. 2185 201	•										•	
HITRONIC® POF SIMPLEX S PE-PUR POF 980/1000, Part No. 2185 205				•		•					•	•
HITRONIC® POF SIMPLEX S PA-PUR POF 980/1000, Part No. 2185 204				•		•					•	•
HITRONIC® POF SIMPLEX PE POF 980/1000, Part No. 2185 001				•		•					•	
HITRONIC® POF SIMPLEX FD PE-PUR POF 980/1000, Part No. 2185 207		•		•		•					•	
HITRONIC® POF DUPLEX FD PE-PUR POF 980/1000, Part No. 2185 213		•		•		•		•	•	•		
HITRONIC® POF SIMPLEX 105 °C XPE POF 980/1000, Part No. 2185 202			•	•		•					•	
HITRONIC® POF DUPLEX PE POF 980/1000, Part No. 2185 010				•		•		•	•	•		
HITRONIC® POF DUPLEX HEAVY PE-PUR POF 980/1000, Part No. 2185 211				•	•	•		•	•	•		
HITRONIC® POF DUPLEX PE-PVC POF 980/1000, Part No. 2185 209								•	•	•		
HITRONIC® POF DUPLEX PVC-PVC POF 980/1000, Part No. 2185 210								•	•	•		
HITRONIC® POF DUPLEX PE-PUR POF 980/1000, Part No. 2185 040				•		•		•	•	•		
HITRONIC® POF MULTI FIBRE PE-PVC Part No. 3036 010				•				•	•	•	•	
HITRONIC® FD P DESINA ® 4 x 1.5 + 2 x POF 980/1000, Part No. 2186 001				•		•	•			•		
Lapp Kabel PCF fibre optic												
HITRONIC® BUS PCF DUPLEX indoor Part No. 2185 311								•	•	•		
HITRONIC® BUS PCF DUPLEX outdoor Part No. 2185 302								•	•	•		
Fibre optic connectors												
SMA-type									•	•	•	
ST-type								•	•	•	•	
HFBT-type								•	•	•	•	
SERCOS®-type										•	•	•
CIRCON® HYBRID							•					
Fibre optic converter												
EPIC® DATA PROFIBUS									•			
EPIC® DATA INTERBUS								•				

Note: Standard lengths without surplus for sectioning: 100 m and 500 m.
o.d. = on demand



Selection Table

T12: Power Rating – Basic Table

Table 12-1: Power rating

Of wires & cables having nominal voltage up to 1000 V and heat resistant wire & cables, ambient temperature 30 °C

Cable or lead category					
	A Single core cable • rubber insulated • PVC insulated • TPE insulated • heat resistant	B Multi core cables and cords for home- and portable apparatus • rubber insulated • PVC insulated • TPE insulated		C Multicore cables + cords, excl. home- + portable apparatus • rubber insulated • PVC insulated • TPE- insulated • heat resistant	D Multicore heavy duty rubber cables ≤ 0.6/1kV Single core special rubber cables 0.6/1kV or 1.8/3kV
Method of installation					
Number of current carrying conductors	1 ³⁾	2	3	2 or 3	3 1 ³⁾
Nominal cross section in mm²	Current rating in A	Current rating in A		Current rating in A	Current rating in A
0.08 ¹⁾	1.5	-	-	1	-
0.14 ¹⁾	3	-	-	2	-
0.25 ¹⁾	5	-	-	4	-
0.34 ¹⁾	8	-	-	6	-
0.5	12 ²⁾	3	3	9 ²⁾	-
0.75	15	6	6	12	-
1.0	19	10	10	15	-
1.5	24	16	16	18	23
2.5	32	25	20	26	30
4	42	32	25	34	41
6	54	40	-	44	55
10	73	63	-	61	70
16	98	-	-	82	98
25	129	-	-	108	132
35	158	-	-	135	176
50	198	-	-	168	218
70	245	-	-	207	276
95	292	-	-	250	347
120	344	-	-	292	416
150	391	-	-	335	488
185	448	-	-	382	566
240	528	-	-	453	644
300	608	-	-	523	775
400	726	-	-	-	898
500	830	-	-	-	-
Sources of current ratings of table 12-1:	DIN VDE 0298-4, 2003-08 Table 11 Column 2	DIN VDE 0298-4, 2003-08 Table 11 Column 3 + 4		DIN VDE 0298-4, 2003-08 Table 11 Column 5	DIN VDE 0298-4, 2003-08 Table 15 Column 4 + 2

Note:

Design of tables 12 to 13 deviates from (58 pages-). VDE 0298-4 design. In case of doubt, appliance of the current issue of the DIN VDE 0298-4 is obligatory. Table 12-1 values have to be taken into consideration of further applicable converting/derating factors:

- Other ambient temperatures: Table 12-2
- more than 3 current carrying cores of multiconductor cables up to 10mm²: Table 12-3
- Ambient temperatures > 50 °C of heat resistant wire & cables: Table 12-4
- for wound, spooled cables: Table 12-5
- Grouping of single core & multi core cables in conduits, raceways, wireways, floor & ceiling: Table 12-6
- Grouping of multi core cables in cable trays: Table 12-7
- Grouping of single core cables in cable trays : Table 12-8

Table 12-1 Column A – D, Cable Categories:

- A: Single cores: LiY, LiCY-EA, H05V-K, H07V-K, H07V2-K, H07Z-K, Multi-standard wiring cable, ÖLFLEX® HEAT 105, -145, ÖLFLEX® HEAT 180 and ÖLFLEX® HEAT 205/260 wires/single core cables.
- B: Multicore cables & service cords for home- and portable apparatus: ÖLFLEX® CLASSIC 100, H05VV-F, 450 P, 500 P 540 P, H05RR-F, H05RN-F, H05BQ-F, H07BQ-F
- C: Multi core power and control cables excluding home and portable apparatus: All ÖLFLEX®, ÖLFLEX® CRANE-, ÖLFLEX® HEAT-, ÖLFLEX® HEAT 180-, ÖLFLEX® HEAT 205/260- cables,
- D: Multi core heavy duty rubber cables U_n/U ≤ 0.6/1kV: ÖLFLEX® CRANE NSHTÖU, ÖLFLEX® CRANE VS, NSHTÖU, NSSHÖU, ÖLFLEX® HEAT-Multicore cables.
Single core special rubber cable U_n/: 0.6/1kV or 1.8/3 kV: NSGAFÖU, NSHXAFÖU; ÖLFLEX® HEAT® 145 single core cables

Current (power) ampacity of other cables:

- Copper earthing cable ESUY see VDE 0105 part 1
- H07RN-F/A 07RN-F/H07BQ-F for industrial use: see catalogue table T12-9.
- Welding cable H01N2-D see catalogue table T12-10.
- Cables for building wiring: NYM, NHXMH, NYY, NYCY, NYCWY, NHXHX see VDE 0298-4, 2003-08, Table 3 & 4.
- Cables & wires in machines: see DIN EN 60204-1/VDE 0113-1
- Cables & wires in machines for USA: see National Electrical Code & NFPA 79, Table 13

- ¹⁾ VDE 0891-1 -borrowed current ratings for conductor sizes < 0.5mm² (0.08-0.34 mm²)
- ²⁾ In terms of VDE 0298-4, 2003-08, Table 11 column 2 extended range for size 0.5 mm².
- ³⁾ Clustering of single core cables in touch to each other or bundled cables:
 - on surfaces: Current rating values of Table 12-1 column A or D,
 - for 1~A.C. or – or D.C.-circuits a derating factor of 0.76
 - for 3~A.C. circuits a derating factor of 0.67
 have to be applied before applying conversion factor of Table 12-6
 - free in air or on cable trays: Current rating values of table 12-1 column A or D,
 - for 1~A.C. – or D.C. circuits a derating factor of 0.8
 - for 3~A.C. circuits a derating factor of 0.7
 have to be applied before applying conversion factor of table 12-8.
 - Attention: Single cores (wires) installed in conduits or pipes in or attached to walls (Installation Methode A1 or B1) in buildings see VDE 0298, tables 3 or 5, column 2, 3, 6, or 7 & table 21.

Table 12-2: Correction Factors

For ambient temperatures different to 30 °C. For heat resistant cables and wires see Table T12-4 (in accordance to DIN VDE 0298-4, 2003-08, Table 17).

Rated temperature of the conductor of wire or cable. (See product page of the catalogue, Technical Data, Temperature range: upper value for static and/or flexing)					
	60 °C	70 °C	80 °C	85 °C	90 °C
Ambient temperature in °C	Correction factor, applicable to current value of T12-1				
10	1.29	1.22	1.18	1.17	1.15
15	1.22	1.17	1.14	1.13	1.12
20	1.15	1.12	1.10	1.09	1.08
25	1.08	1.06	1.05	1.04	1.04
30	1.00	1.00	1.00	1.00	1.00
35	0.91	0.94	0.95	0.95	0.96
40	0.82	0.87	0.89	0.90	0.91
45	0.71	0.79	0.84	0.85	0.87
50	0.58	0.71	0.77	-	0.82
55	0.41	0.61	0.71	-	0.76
60	-	0.50	0.63	-	0.71
65	-	0.35	0.55	-	0.65
70	-	-	0.45	-	0.58
75	-	-	0.32	-	0.50
80	-	-	-	-	0.41
85	-	-	-	-	0.29

Table 12-3: Correction Factors

for multiconductor cables and cords, having conductor size up to 10 mm² (DIN VDE 0298-4, 2003-08. Table 26)

Number of current carrying conductors	Correction factors for cables in free air	Correction factors for cables in earth (burial)
5	0.75	0.70
7	0.65	0.60
10	0.55	0.50
14	0.50	0.45
19	0.45	0.40
24	0.40	0.35
40	0.35	0.30
61	0.30	0.25



Table 12-4: Correction factors of heat resistant cables and wires

Cables and wires classified according to its rated temperature of the conductor (See product page of the catalogue "Technical Data, Temperature Range, for upper value for static and/or flexing use").				
	ÖLFLEX® HEAT 105 H07V2-K ÖLFLEX®-FD ROBUST H07Z-K 90 °C	Halogen free single core H07Z-K 110 °C	ÖLFLEX® HEAT 145	ÖLFLEX® HEAT 180 Silicone rubber
Ambient temperature in °C	Correction factors, applying to current value of Table 12-1, column A, C or D for heat resistant wires and cables (Source: DIN VDE 0298-4, 2003-08, Table 18)			
up to 50	1.00	1.00	1.00	1.00
55	0.94	1.00	1.00	1.00
60	0.87	1.00	1.00	1.00
65	0.79	1.00	1.00	1.00
70	0.71	1.00	1.00	1.00
75	0.61	1.00	1.00	1.00
80	0.50	1.00	1.00	1.00
85	0.35	0.91	1.00	1.00
90	-	0.82	1.00	1.00
95	-	0.71	1.00	1.00
100	-	0.58	0.94	1.00
105	-	0.41	0.87	1.00
110	-	-	0.79	1.00
115	-	-	0.71	1.00
120	-	-	0.61	1.00
125	-	-	0.50	1.00
130	-	-	0.35	1.00
135	-	-	-	1.00
140	-	-	-	1.00
150	-	-	-	1.00
155	-	-	-	0.91
160	-	-	-	0.82
165	-	-	-	0.71
170	-	-	-	0.58
175	-	-	-	0.41

Table 12-5: Correction factors

of spooled/winded cables (DIN VDE 0298-4, 2003-8. Table 27)

Number of layers on spool, reel or drum	1	2	3	4	5
Correction factor	0.80	0.61	0.49	0.42	0.38

For helix-type coiled/winded cables (spiral in one layer) the correction factor is 0.8.

Table 13-1: Power ampacity to single core and multi core cables acc. to NEC (USA)

Abstract of NEC Tabelle 310-16

Allowable ampacity (in Ampere) of insulated conductors, rated 0 – 2000 Volts, 60 °C to 90 °C, NOT MORE THAN THREE CONDUCTORS in raceway or cable one Earth (direct burial), based on ambient temperature of 30 °C

Abstract of NEC Tabelle 310-17

Allowable Ampacity (in Ampere) of SINGLE INSULATED CONDUCTORS, rated 0 – 2000 Volts, in free air, based on ambient temperature of 30 °C

Conductor size		Temperature Rating of Conductor			Conductor size		Temperature Rating of Conductor		
AWG or kcmil (MCM)	60 °C (140 °F)	75 °C (167 °F)	90 °C (194 °F)	AWG or kcmil (MCM)	60 °C (140 °F)	75 °C (167 °F)	90 °C (194 °F)		
18	-	-	14	18	-	-	18		
16	-	-	18	16	-	-	24		
14	20*	20*	25*	14	25*	30*	35*		
12	25*	25*	30*	12	30*	35*	40*		
10	30	35*	40*	10	40*	50*	55*		
8	40	50	55	8	60	70	80		
6	55	65	75	6	80	95	105		
4	70	85	95	4	105	125	140		
3	85	100	110	3	120	145	165		
2	95	115	130	2	140	170	190		
1	110	130	150	1	165	195	220		
1/0	125	150	170	1/0	195	230	260		
2/0	145	175	195	2/0	225	265	300		
3/0	165	200	225	3/0	260	310	350		
4/0	195	230	260	4/0	300	360	405		
250	215	255	290	250	340	405	455		
300	240	285	320	300	375	445	505		
350	260	310	350	350	420	505	570		
400	280	355	380	400	455	545	615		
500	320	380	430	500	515	620	700		
600	355	420	475	600	575	690	780		

* Note: Unless otherwise specifically permitted elsewhere in the NEC, the overcurrent protection for conductor types marked with an * shall not exceed 15 amperes for AWG 14, 20 amperes for AWG 12 and 30 amperes for AWG 10, after any correction factors for ambient temperature and numbers of conductors have been applied.

Correction factors for ambient temperatures other than 30 °C				Correction factors for more than three current-carrying conductors in a raceway or cable.	
Ambient temperature in °C	60 °C	75 °C	90 °C	Number of current-carrying conductors	Correction factor
21 – 25	1.08	1.05	1.04	4 up to 6	0.80
26 – 30	1.00	1.00	1.00	7 up to 9	0.70
31 – 35	0.91	0.94	0.96	10 up to 20	0.50
36 – 40	0.82	0.88	0.91	21 up to 30	0.45
41 – 45	0.71	0.82	0.87	31 up to 40	0.40
46 – 50	0.58	0.75	0.82	41 and more	0.35
51 – 55	0.41	0.67	0.76		
56 – 60	-	0.58	0.71		
61 – 70	-	0.33	0.58		
71 – 80	-	-	0.41		



Selection Table

T15: Properties of insulating and sheathing materials

Only for the basic materials. Variations are possible depending on application/design. See the relevant catalogue page.

Material	Parameter											
	Abbreviation	VDE symbol	working temperature	dielectric constant (10^{-3})	volume resistivity ($\Omega \times \text{cm}$)	tensile strength N/mm ² MPa	Elongation %	Water absorption (20 °C) %	Weather resistance	Fuel resistance	Oil resistance	Flammability
Bio-oil resistant material	Lapp type: P4/11	–	-40 +120	2.4	10^{15}	10 – 20	450 – 550	1 – 2	very good	good	Bio-oil resistant very good	flammable
Polyvinylchloride	PVC	Y	-30 +70	4.0	$10^{12} - 10^{15}$	10 – 25	150 – 300	0.4	moderate	moderate	good	self-extinguishing
Polyvinylchloride heat resistant	PVC	Y	-20 +90	3.5	$10^{12} - 10^{15}$	10 – 25	150 – 300	0.4	moderate	moderate	good	self-extinguishing
High pressure Polyethylene	LDPE	2Y	-50 +70	2.3	10^{17}	20 – 30	500	0.1	good	poor	moderate	flammable
Low Pressure Polyethylene	HDPE	2Y	-50 +100	2.3	10^{17}	30	800	0.1	moderate	poor	moderate	flammable
Polyurethane	PUR	11Y	-40 +90/100	4.0 – 6.0	10^{12}	30 – 45	300 – 600	1.5	very good	good	good	self-extinguishing*
Polyamide	PA	4Y	-40 +80	3.5 – 7.0	10^{14}	50 – 180	200 – 300	1 – 2	good	moderate	good	flammable
Polybutylene terephthalate	PBTP	–	-60 +110	3.0 – 4.0	10^{16}	50 – 100	50 – 300	0.5	good	good	good	flammable
Polytetrafluorethylene	PTFE	5Y	-190 +260	2.1	10^{18}	14 – 40	240 – 400	0.01	very good	very good	very good	non-flammable
Tetrafluorethylene Hexafluorpropylene Copolymer	FEP	6Y	-100 +200	2.1	10^{18}	20 – 25	250 – 350	0.01	very good	very good	very good	non-flammable
Ethylene-tetrafluorethylene	ETFE	7Y	-100 +150	2.6	10^{16}	40 – 50	100 – 300	0.01	very good	very good	very good	non-flammable
Perfluoralkoxy-polymer	PFA	–	-190 +260	2.1	10^{15}	30	300	0.01	very good	very good	good	non-flammable
Chloropren rubber	CR	5G	-40 +100	6.0 – 8.0	10^{13}	25	450	1	very good	poor	good	self-extinguishing
Silicone rubber	SI	2G	-60 +180	2.8 – 3.2	10^{15}	5 – 10	200 – 350	1.0	very good	poor	moderate	less flammable
Ethylene vinyl acetate	EVA	4G	-30 +125	5 – 7	10^{13}	5	200	0.01	good	poor	poor	flammable
Ethylene propylen rubber	EPDM	3G	-30 +120	3.2	10^{14}	5 – 25	200 – 450	0.02	good	poor	poor	flammable
Thermoplastic polyolefin elastomer	TPE-O	–	-40 +120	2.7 – 3.6	5×10^{14}	≥ 6	≥ 400	1.5	very good	moderate	moderate	flammable
Thermoplastic polyester elastomer	TPE-E	12Y	-70 +125	3.7 – 5.1	10^{12}	3 – 25	280 – 650	0.3 – 0.6	very good	good	very good	flammable
Styrene triple block copolymer	TPE-S	–	-75 +105/140	2.2 – 2.6	10^{16}	9 – 25	500 – 700	1 – 2	moderate	good	poor	flammable

* only with additional flame retardener

British and US Dimensions for Cables and Leads

According to US regulations the dimensions of copper conductors for power and data transmission purpose are usually expressed in AWG Nos*. The corresponding values are:

AWG/KCMIL No.	Diameter section mm	Cross geometric (mm ²)	Conductor resistance (Ω/km)
500	17.96	253	0.07
350	15.03	177	0.10
250	12.70	127	0.14
(4/0)	11.68	107.2	0.18
(3/0)	10.40	85.0	0.23
(2/0)	9.27	67.5	0.29
(1/0)	8.25	53.5	0.37
1	7.35	42.4	0.47
2	6.54	33.6	0.57
4	5.19	21.2	0.91
6	4.12	13.3	1.44
8	3.26	8.37	2.36
10	2.59	5.26	3.64
12	2.05	3.31	5.41
14	1.63	2.08	8.79

AWG/KCMIL No.	Diameter section mm	Cross geometric (mm ²)	Conductor resistance (Ω/km)
16	1.29	1.31	14.7
18	1.024	0.823	23.0
20	0.813	0.519	34.5
22	0.643	0.324	54.8
24	0.511	0.205	89.2
26	0.405	0.128	146
28	0.320	0.0804	232
30	0.255	0.0507	350
32	0.203	0.0324	578
34	0.160	0.0200	899
36	0.127	0.0127	1426
38	0.102	0.00811	2255
40	0.079	0.00487	3802
42	0.064	0.00317	5842
44	0.051	0.00203	9123

* AWG = American Wire Gauge (American scale unit for wire cross section)

General dimensions*:

The basic units are in the english gravitational system:
length (ft) - force (lbf = Lb) - time (s)

in the english absolute system:
length (ft) - mass (lb) - time (s)

Length dimensions

1 mil	= 0.0254 mm
1 inch (in;")	= 25.4 mm
1 foot (ft;')	= 0.305 m
1 yard (yd)	= 0.914 m
1 chain (ch)	= 20.1 m
1 statue mile	= 1.61 km
1 nautical mile	= 1.835 km
1 statute mile	= 1760 yards

Cubic dimensions

1 cubic inch	= 16.39 cm ³
1 cubic foot	= 0.0283 m ³
1 cubic yard	= 0.765 m ³
1 US liquid gallon	= 3.79 l
1 pint	= 0.473 l
1 quart	= 0.946 l
1 brit gallon	= 4.53 l
1 barrel	= 119.2 l

Area dimensions

1 circ. mil (CM)	= 0.507 · 10 ⁻³ mm ²
1 kcmil (MCM)	= 0.5067 mm ²
1 square inch (sq. in.)	= 645.16 mm ²
1 square foot (sg.ft.)	= 0.0929 m ²
1 square yard	= 0.836 m ²
1 acre	= 0.00405 km ²
1 square mile	= 2.59 km ²
1 m ²	= 10.764 sq. ft.

Mass units

English gravitation system:
1 slug = 1 lbs · s²/ft

English absolute system:
1 pound = 1 lb

1 slug = 32.174 lb, with 32.174 ft/s²
as the standard value of acceleration due to gravity

1 grain	= 64.80 mg
1 dram	= 1.770 g
1 ounce (oz)	= 16 drams = 28.35 g
1 pound (lb)	= 16 oz = 453.59 g
1 stone	= 14 lbs = 6.35 kg
1 US ton (short ton)	= 0.907 t
1 Brit. ton (long ton)	= 0.016 t

Units of force

English gravitational system:
pound-force 1 lbf = 1 Lb

English absolute system:
poundal 1 pdl = 1 lb · ft/s²

1 lbf = 32.174 pdl - 9.80665 lb · m/s²

Conversion to metric units:

1 pound-force (lbf)	= 0.454 kp
1 Brit. ton-force	= 1016 kp
1 poundal (pdl)	= 0.1383 N
1 lbf	= 4.445 N

Electrical unit per unit length:

1µf per mile	= 0.62 µF/km
1 megohm per mile	= 1.61 MΩ · km
1 megohm per 1000 ft	= 3.28 Ω · km
1 ohm per 1000 yd	= 1.0936 Ω/km

Weight per unit length^t

1 lb per foot	= 1.488 kg/m
1 lb per yard	= 0.469 kg/m
1 lb per mile	= 0.282 kg/m

Density

1 lb/ft ³	= 16.02 kg/m ³
----------------------	---------------------------

Weight (specific weight)

1 lbf/ft ³	= 16.02 kp/m ³
-----------------------	---------------------------

Copper wire weight per mile

lb/mile	Ø mm
5	0.404
6.5	0.51
7.5	0.55
10	0.64
20	0.90
40	1.27

Units of energy

1 horsepower	= 0.746 kW (H.P.)
1 brit. therm. unit	= 0.252 kcal

The insulation wall thickness is often expressed in n/64 inches, 1/64 inch being roughly equaled to 0.4 mm.

Further dimensjons for wire weihjts and for electrical field strengths:

lbf pr. MFeet	= 1.488 kg/km
lbf pr. Mile	= 0.282 kg/km

40 V/mil	= 1.6 kV/mm
80 V/mil	= 3.2 kV/mm
100 V/mil	= 4.0 kV/mm
250 V/mil	= 10.0 kV/mm

* these units are mostly not in use. They are for information only.



Selection Table

T18: Approvals and trademarks

Because of their outstanding characteristics, many of our products have been tested and authorized by the following approval organisations:



UNDERWRITERS
LABORATORIES INC.



LISTED COMPONENT MARK FOR
CANADA AND UNITED STATES



ISTITUTO ITALIANO
DEL MARCHIO DI UALITÀ



LLOYD'S REGISTER
OF SHIPPING



CANADIAN STANDARDS
ASSOCIATION



PHYSIKALISCH-TECHNISCHE
BUNDENSANSTALT



ZERTIFIKAT
GERMANISCHER LLOYD



VERBAND DEUTSCHER
ELEKTROTECHNIKER

eingetragen

im Musterregister beim
Amtsgericht Stuttgart



SCHWEIZERISCHER
ELEKTROTECHNISCHER VEREIN



GGVS
Gefahr-Gut-Verordnung-Straße
EN 220500 ff.



"Gost R" Certification for Russia

Tightening torque* for SKINTOP® glands metric

Table of the recommended tightening torque (cap nut, connection thread) for SKINTOP® metric version for attainment of protection category IP 68-5 bar and strain relief of category A acc. to EN 50262

Thread	Tightening torque in Nm	
	Polymer	Metal
M12 x 1.5	1.5	8
M16 x 1.5	3.0	10
M20 x 1.5	6.0	12
M25 x 1.5	8.0	12
M32 x 1.5	10.0	18
M40 x 1.5	13.0	18
M50 x 1.5	15.0	20
M63 x 1.5	16.0	20
M63 Plus	-	25

* **Note:** For ATEX cable glands please find the tightening torques in the corresponding operation manuals. (Operation manual attached to the delivery bag)

Tightening torque values* according to DIN/VDE 0619, Point 7 for SKINTOP® glands PG

Thread	Torque for the intermediary in Nm		Torque for the cap nut in Nm
	Polymer	Metal	Polymer
PG 7	2.5	6.25	1.7
PG 9	3.75	6.25	2.5
PG 11	3.75	6.25	2.5
PG 13.5	3.75	6.25	2.5
PG 16	5.0	7.5	3.3
PG 21	7.5	10.0	5.0
PG 21	7.5	10.0	5.0
PG 29	7.5	10.0	5.0
PG 36	7.5	10.0	5.0
PG 42	7.5	10.0	5.0
PG 48	7.5	10.0	5.0

* **Reference:** Above values obtain as tightening torques for the intermediary, as well as maximal tightening torques for the cap nuts. To prevent damages of the outer sheath please note that the different cable materials require various torques.

Fitting dimensions and widths across flats

The diameter A indicates the assembly space required for the relevant hexagon. This diameter corresponds to the width across corner of the hexagon, plus an assembly tolerance.

SW	ø A	SW	ø A	SW	ø A
9	10.4	26	29.5	46	52.5
11	12.5	27	30.6	47	52.5
13	14.9	28	31.8	50	58.3
14	16.0	29	32.5	53	60.0
15	17.1	30	34.0	54	61.0
16	18.2	32	36.2	55	62.0
17	19.4	33	37.2	57	64.4
18	20.4	36	40.5	60	67.5
19	22.0	37	41.5	64	72.3
20	22.7	39	44.0	65	73.1
21	23.9	40	45.2	66	74.5
22	25.0	41	46.1	67	74.5
24	27.3	42	47.0		
25	28.3	45	51.2		

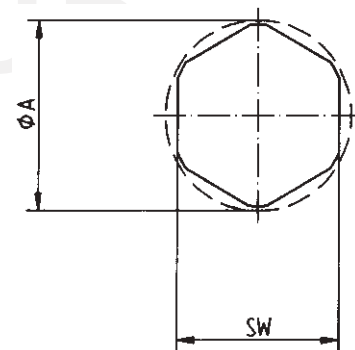

Selection Table

T22: Protection classes to EN 60529

Definition of the protection category acc. to EN 60529 (DIN 0470)

The protection category is mentioned as a short mark which consists of two unvarying letters IP and ratios for the protection level, for example IP 54.

Protection Classes for protection against foreign bodies

First figure	Designation	Scope of protection – explanation
0	No protection	
1	Protection against large foreign bodies > 50 mm ϕ	Protection against accidental, large-surface contact with active or internal moving parts, e.g. with the hand, but no protection against deliberate access to these parts. Protection against penetration of solid foreign bodies with a diameter larger than 50 mm.
2	Protection against medium-sized foreign bodies > 12.5 mm ϕ	Protection against contact by the fingers with active or internal moving parts. Protection against penetration of solid foreign bodies with a diameter larger than 12 mm.
3	Protection against small foreign bodies > 2.5 mm ϕ	Protection against contact with active or internal moving parts with tools, wires, etc. of a thickness greater than 2.5 mm. Protection against penetration of solid foreign bodies with a diameter larger than 2.5 mm.
4	Protection against granula foreign bodies > 1.0 mm ϕ	Protection against contact with active or internal moving parts with tools, wires, etc. of a thickness greater than 1 mm.
5	Protection against accumulation of dust	Complete protection against contact with live or internal moving parts, protection against harmful dust accumulations. The penetration of dust is not completely prevented, but the dust may not penetrate in such quantities that the mode of operation is restricted.
6	Protection against ingress of dust	Complete protection against contact with live or internal moving parts. Protection against the ingress of dust.

Protection Classes for water protection

Second figure	Designation	Scope of protection – explanation
0	No protection	
1	Protection against dripping water falling vertically	Water drops which fall vertically must not have any harmful effect.
2	Protection against dripping water falling at an angle	Water drops which fall at any angle from 15° to the vertical, may not have any harmful effect.
3	Protection against sprayed water	Water which falls at any angle up to 60° to the vertical, must not have any harmful effect
4	Protection against splashed water	Water which splashes from all directions onto the equipment must not have any harmful effect.
5	Protection against water jet	A water jet from a nozzle, which is directed from any direction against the equipment, must not have any harmful effect.
6	Protection against flooding	In the event of temporary flooding, e.g. in heavy seas, water may not penetrate into the equipment in harmful quantities.
7	Protection against immersion	Water may not penetrate in harmful quantities when the equipment is immersed in water under the prescribed pressure and time conditions.
8	Protection against submersion	Water may not penetrate in harmful quantities if the equipment is submerged under water.

Example: Identifying letters IP 65

Second figure: Protection against liquids.

First figure: Protection against contact penetration of foreign bodies.

Table 29-1: UL-Marking at Cables & Wires and its intended use

UL or (UL) UL Listing Mark for listed cables & wires

UL Listed Cables and Wires covered by this category are intended for use as fixed wiring for three general building types: residential, commercial and industrial. Listed wire and cable must not only comply with the applicable individual UL standards but also with requirements indicated under specific Articles of the National Electrical Code.

The National Electrical Code defines specific end use application and where a

particular Listed wire or cable is installed. Listed cables and wires are applicable for factory wired equipment (such as electrical devices, equipment, appliances, as well as machines) as well as for local field wiring purpose (see NEC & NFPA 79).

Typical type designations of Listed cables, wires and flexibel cords:
MTW, TC, PLTC, CM, CL2, THHN, THWN; SO, SOO, ST, STO, SJT, SJTO.

Some Lapp Kabel multi listed/ multi approved products:
ÖLFLEX® TRAY II, ÖLFLEX® VFD TC; ÖLFLEX® CONTROL TM/ÖLFLEX® CONTROL M ÖLFLEX® TRAY 3D; ÖLFLEX® AUTO-X; Multi Standard Wiring Cable UL(MTW)-CSA-HAR; UNITRONIC® BUS

Approval mark at the product:
(UL) = UL Listing mark.

UL Recognition Mark for AWM cables and wires

Appliance Wiring Material better known under the abbreviation of "AWM" covers wire and cable intended for use as factory installed components of a complete equipment, such as electrical devices, appliances. In control panels or industrial machines only if as a part of a listed assembly (NFPA 79 Edition 2007).

Appliance Wiring Material is not intended for use in direct separate installation in the field. Wire or cable indicating a UL AWM style marking is intended for applications that are unique to each individual style sheet. The usage statement of an individual style sheet will indicate specific end use limitations of the AWM wire or cable.

If a Manufacturer desires to obtain NRTL listing for their new piece of equipment

they must submit their design to the NRTL. The entire listing process will move much more quickly and easily if all internal components used within the equipment design are UL listed or UL recognized.

If the internal components are not UL listed or UL recognized then the Listing process will take much longer and cost more as the individual components now must be tested for compliance. AWM can also be used externally to interconnect the Listed Components such as the data assembly that connects a computer to a printer (see www.ul.com).

Note:
Multinorm cables and wires. Metric- (mm²) and AWG/MCM-conductor sizes of multinorm cables and wires often do have spe-

cial conductor strands, so one of both of the conductor sizes is typically (slightly) oversized regarding its nominal cross section. This may occur a particular wiring problem when clamping range of the terminal is strictly limited to one unique gage size.

Futher informations to that subject:
Table T 11 Conductor resistance and conductor make-up (metric)
Table T 16 Anglo-American Units
Table T 13 Power Ampacity to cables & wires NFPA 70 (National Electrical Code)
NFPA 79 Electrical Standard of Industrial Machinery

LAPP GROUP



Table 29-2: NFPA – Use of Cables and Wires for Industrial Machinery in the USA

NFPA 79 is the section of the National Electric Code (NEC®) that focuses on the electrical wiring standards used with industrial machinery. NFPA 79 applies to the electrical equipment used within a wide variety of machines, as well as groups of machines working together in a coordinated manner. Examples of industrial machinery include, among others: machine

chapter structure to follow IEC/EN 60204 while adopting state-of-the-art safety standards. As of January 2007, one of the major changes in the NFPA 79 is the cable selections required under section 12.2.7.3. This section states that (Note: ...within the scope of NFPA 79) single conductor or multi-conductor AWM (Note: ...nowadays still widely spread) shall not be permitted,

proper cable selection for industrial machinery. Especially with present day global supply access, the tightening of NFPA79 requires much more attention to cable selection to ensure performance reliability.

We strive to keep our customers aware of breaking industry changes. In a tight cooperation with our colleagues from Lapps manufacturing- and sales center at Florham Park, New Jersey www.lappusa.com Lapp offers a variety of product solutions that are UL Listed and conform to the NFPA 79, 2007 Edition. E.g. ÖLFLEX® CONTROL M, ÖLFLEX® CONTROL TM, ÖLFLEX® TRAY II.

Please find further information at: www.lappkabel.de => Products => NFPA 79



The diagram illustrates key NEC® and NFPA regulatory codes for an industrial plant manufacturing floor. Each code calls out permissible cables. 'NEC®' is a registered trademark of the National Fire Protection Association.

tools, injection molding machines, wood-working equipment, assembling machinery, material handling machinery – in general machines to process and to transfer material. This is clearly differentiated from e.g. equipment for 'people transfers'.

The scope of NFPA 79 includes all electrical and electronic elements of the machinery operating at 600V or less. In 2006, the NFPA 79 code underwent significant revisions. The main goal of the revision was to further harmonize NFPA 79 with its European counterpart, IEC/EN 60204. This involved reorganizing the NFPA 79

unless the completed assembly has been listed prior for such use. (Note: ...'complete assembly' often refers to electrical sub-systems, described by an UL-standard, e.g. Industrial Control Panels in acc. with UL-508A) Machine Tool Wire (MTW) is one of the wire and cable permissible options. Wiring inbetween a group of machines often makes Tray Cables (TC) become the best economical solution in compliance with NFPA 79.

Today, with ever increasing concerns of liability issues it is more important than ever to meet regulatory requirements and

Table 29-3: NFPA – Use of Cables and Wires for Industrial Machinery in the USA

General requirements regarding design, manufacturing and usage of Industrial Machinery in USA

Machinery may accepted as being safe if they are desigend, manufactured and tested according federal law issued by the Occupational Safety and Health Administration (OSHA: www.osha.gov) as well as to local (State-, County-, City-) laws and safety has been testified and certified by a Nationally Recognized Testing Laboratory (NRTL). A NRTL listing or -labeling mark at the machine is required as the “visual proof” to local inspectors (Authorities having Jurisdiction) as being tested and certified.

NFPA 79 Electrical Standard for Industrial Machinery Edition 2007

The National Fire Protection Assosiation (www.nfpa.org) is authorised issuer of that important Electrical Standard for Industrial Machinery.

NFPA 79 Edition 2007 quasi is the US-American counterpart to the International Standard IEC 60204-1 = European Standard EN 60204-1, regarding safety of machinery. NFPA 79, Chapter 12 covers requirements regarding use of cables & wires for machines.

Conductors, cables and cords shall be listed Type AWM shall be permissible, when part of a listed assembly suitable for the intended application.

Herewith some general requirements:

- Conductors of motor supply cables shall have an ampacity not less than 125% of the motor full-load current rating.
- Minimum conductor size for power circuits is 14AWG.
- Minimum conductor size for lightning and control circuits is 18AWG
- Minimum conductor size for electronic-programmable control circuits (inputs/ outputs) is 24AWG.
- The combined cross-sectional area of all conductors and cables shall not exceed 50% of the interior cross-sectional area of the raceway, conduit or wireway.
- Conductors and cables shall not be subject of mechanical, chemical and thermal effects based damages.

A common method of protection is wiring inside of raceways, wireways and conduits along its entire run. Cables on cable trays must have a “cable tray rating”. In industrial establishments where the conditions of maintenance and supervision ensure that only qualified persons service the installation, TC cable having additional approval for “open wiring” is allowed to be used from tray to a peace of equipment without the use of conduits [NEC® <NFPA 70> 2008, Article 336.10(6)].

In Fall 2003 the requirement of marking “open wiring” of TC cables have been changed into marking “Exposed Run (-ER)” by decision of the UL Standards Technical

Panel for power cables. Use of TC cables having “open wiring” or “exposed run”-approvals, such as Lapp Kabel ÖLFLEX® CONTROL M+TM, ÖLFLEX® TRAY II, ÖLFLEX® VFD CT, ÖLFLEX® AUTO X, ÖLFLEX® AUTO I, ÖLFLEX® 190 cables, allows much more faster and cost-saving installations.

NFPA 79 refers in specific aspects to the National Electrical Code (NEC, USA). Chapter 1.4.1. Wiring between component machines of an industrial manufacturing system shall be covered by NFPA 70 (NEC). Especially if machinery wiring is attached to the building. In such cases it have to be done by an adequate wiring method described by relevant articles of the NEC.

NEC (National Electrical Code) Handbook Edition NEC® <NFPA 70> 2008

This code covers the standard NFPA 70. The Handbook Edition offers additional informations given by tables, grafics, pictures, comments e.t.c. The NEC Handbook as well as NFPA 79 Standard is available via NFPAs webside: www.nfpa.org

UL 508-A Moreover:

Industrial Control Panels can be designed, manufactured and labeled under UL 508-A Standard (www.ul.com).



Selection Table

T29: Use of UL-approved Cables and Wires

Table 29-4: Survey of respective products in this catalogue ('Listed')

Lapp cables with UL listing	Listed type	Rated voltage in V	Rated Temperature in °C	Material
Multi standard wiring cable UL(MTW)-CSA-HAR Style 1015	MTW	600	90	PVC
Multi standard wiring cable UL(MTW)-CSA-HAR Style 10269	MTW	600	90	PVC
ÖLFLEX® SOLAR XL multi	USE-2, RWU90	600	90	Cross linked Co-Polymer
ÖLFLEX® CONTROL M	MTW, TC-ER, WTTTC	1000	90	Special-TPE compound
ÖLFLEX® CONTROL TM	MTW, TC-ER, WTTTC	1000	90	Special-PVC-compound
ÖLFLEX® CONTROL TM CY	MTW, TC-ER, WTTTC	1000	90	Special-PVC-compound
ÖLFLEX® Tray II	MTW, TC-ER or DP-1, WTTTC	1000	90	Special-PVC-compound
ÖLFLEX® Tray II CY	MTW, TC-ER or DP-2, WTTTC	1000	90	Special-PVC-compound
UNITRONIC® 300	CMG, PLTC, Open Wiring, Oil Res 1	300	105	PVC
UNITRONIC® 300 CY	CMG, PLTC, Open Wiring, Oil Res 1	300	105	PVC
UNITRONIC® FD P plus UL/CSA	CMX	250	75	PUR
UNITRONIC® FD CP plus UL	CMX	250	75	PUR
UNITRONIC® FD CP (TP) plus UL	CMX	250	75	PUR
UNITRONIC® BUS IBS UL/CSA (CMX)	CMX	250	70	PVC
UNITRONIC® BUS P COMBI IBS UL/CSA	CMX	250	75	PUR
UNITRONIC® BUS FD P IBS UL/CSA	CMX	250	70	PUR
UNITRONIC® BUS FD P COMBI IBS UL/CSA	CMX	450	70	PUR
UNITRONIC® BUS Yv IBS UL/CSA	CMX	250	75	PVC
UNITRONIC® BUS Yv Combi IBS UL/CSA	CMX	250	75	PVC
UNITRONIC® BUS LD UL/CSA	CMX	250	70	PVC
UNITRONIC® BUS FD P LD UL/CSA	CMX	250	75	PUR
UNITRONIC® BUS L2/FIP UL/CSA	CMX	250	75	PVC
UNITRONIC® BUS L2/FIP FC UL/CSA	CMG	100	60	PVC
UNITRONIC® L2/FIP 7-wire FC UL/CSA	CMX	250	75	PVC
UNITRONIC® BUS L2/FIP H FC UL/CSA	CMX	100	75	FRNC
UNITRONIC® BUS L2/FIP PUR FC UL/CSA	CMX	100	75	PUR
UNITRONIC® BUS FD P L2/FIP UL/CSA	CMX	250	70	PUR
UNITRONIC® BUS L2/FIP TORSION	CMX	250	60	PUR
UNITRONIC® BUS L2/FIP FESTOON	CMG	250	80	PVC
UNITRONIC® BUS HFFR L2/FIP FC UL/CSA	CMG	250	60	PUR
UNITRONIC® BUS PA (BU) UL/CSA	CMX	100	75	PVC
UNITRONIC® BUS PA (BK) UL/CSA	CMX	100	75	PVC
UNITRONIC® BUS PA (BU) FC UL/CSA	CMG	100	75	PVC
UNITRONIC® BUS PA (BK) FC UL/CSA	CMG	100	75	PVC
UNITRONIC® BUS FF 3 (YE) UL/CSA	CMG	300	105	PVC
UNITRONIC® BUS FF 3 ARM (YE) UL/CSA	CMG	300	105	PVC
UNITRONIC® BUS FF 3 ARM (BU) UL/CSA	CMG	300	105	PVC
UNITRONIC® BUS FF 2 (YE) UL/CSA	CMG	300	105	PVC
UNITRONIC® BUS CCL UL/CSA	CM/PLTC	300	70	PVC
UNITRONIC® BUS CAN UL/CSA	CMX	250	75	PVC
UNITRONIC® BUS FD P CAN UL/CSA	CMX	250	70	PUR
UNITRONIC® BUS ASI (PVC)	CMG	300	80	PVC
UNITRONIC® BUS SAFETY UL/CSA	CMX	250	75	Compound
UNITRONIC® DeviceNet FRNC THICK	CMG	300	80	thermoplastic Copolymer FRNC
UNITRONIC® DeviceNet FRNC THIN	CMG	300	80	thermoplastic Copolymer FRNC
UNITRONIC® DeviceNet THICK	CMG	300	80	PVC
UNITRONIC® DeviceNet THIN	CMG	300	80	PVC
UNITRONIC® DeviceNet ECO THICK PVC UL/CSA (CMG)	CMG	300	80	PVC
UNITRONIC® DeviceNet ECO THIN PVC UL/CSA (CMG)	CMG	300	80	PVC
UNITRONIC® FD P DeviceNet THICK UL/CSA	CMX	300	80	PUR
UNITRONIC® FD P DeviceNet THIN UL/CSA	CMX	300	80	PUR
UNITRONIC® FD Y DeviceNet THICK UL/CSA	CMG	300	80	PVC
UNITRONIC® FD Y DeviceNet THIN UL/CSA	CMG	300	80	PVC
ETHERLINE(R) Y UL/CSA CAT.5e	CMX	125	75	PVC
ETHERLINE(R) Y FC UL/CSA CAT	CMG	600	75	PVC
ETHERLINE(r) YY CAT.5e UL/CSA	CMG	125	70	PVC
ETHERLINE(R) Y FLEX FC UL/CSA CAT.5	CMG	600	70	PVC
ETHERLINE(R) MARINE FRNC FC ULCSA (CMG) CAT.5e	CMG	300	75	thermoplastic Copolymer FRNC
ETHERLINE(R) FD P FC UL/CSA CAT.5	CMX	300	75	PUR

Table 29-5: Survey of respective products in this catalogue ('AWM')

Lapp cables with AWM-Style	Style number	Rated voltage in V	Rated temperature in °C	Material
Multi-Standard wiring cable UL(MTW)-CSA-HAR Style 1015	1015	600	105	PVC
Multi-Standard wiring cable UL(MTW)-CSA-HAR Style 10269	10269	1000	105	PVC
Multi-Standard wiring cable UL-CSA-HAR Style 1007+1569	1007, 1569	300	105	PVC
ÖLFLEX® 150 CY QUATTRO	2587, 21098	600	90	PVC
ÖLFLEX® 150 CY QUATTRO CCC	2587, 21098	600	90	PVC
ÖLFLEX® 150 QUATTRO	2587, 21098	600	90	PVC
ÖLFLEX® 150 QUATTRO CCC	2587, 21098	600	90	PVC
ÖLFLEX® 191	2587, 21098	600	90	PVC
ÖLFLEX® 191 CY	2587, 21098	600	90	PVC
ÖLFLEX® 491 CP	20234	600	80	PUR compound
ÖLFLEX® 491 P	20234	600	80	PUR compound
ÖLFLEX® CLASSIC 130 H UL	21089	600	70	Special compound halogen free
ÖLFLEX® CLASSIC 135 CH UL	21089	600	70	Special compound halogen free
ÖLFLEX® CONTROL M	20886	1000	105	Special-TPE compound
ÖLFLEX® CONTROL TM	20886	1000	105	Special-PVC-compound
ÖLFLEX® CONTROL TM CY	20886	1000	105	Special-PVC-compound
ÖLFLEX® FD 891	2587, 21098	600	90	PVC
ÖLFLEX® FD 891 CP	20234	600	80	PUR-compound
ÖLFLEX® FD 891 CY	2587, 21098	600	90	PVC-compound
ÖLFLEX® FD 891 P	20234	600	80	PVC-compound
ÖLFLEX® FD 90	10107	600	90	PVC-compound
ÖLFLEX® FD 90 CY	10107	600	90	PVC-compound, DESINA®-conform
ÖLFLEX® HEAT 180 UL/CSA	4476/3529	600	150	Silicone-rubber
ÖLFLEX® HEAT 180 C UL/CSA	4476/3529	600	150	Silicone-rubber
ÖLFLEX® ROBOT F1 UL/CSA	20940	up to & incl. 1.5 mm²: 600 V up from 2.5 mm²: 1000	80	PUR-compound
ÖLFLEX® SERVO 709 CY	20886	1000	90	PVC-compound
ÖLFLEX® SERVO 9YSLCY-JB	2570, 20886	1000	80	PVC
ÖLFLEX® SERVO 9YSLCYK-JB	2570, 20886	1000	80	PVC
ÖLFLEX® SERVO FD 790 CP	without control pairs: 20234 including control pairs: 20235	Power cores: 600 Control cores: 300	80	PUR-compound, DESINA®-conform
ÖLFLEX® SERVO FD 795 CP	without control pairs: 20234 including control pairs: 20235	Power cores: 600 Control cores: 300	80	PUR-compound, DESINA®-conform
ÖLFLEX® SERVO FD 795 P	without control pairs: 20234 including control pairs: 20235	Power cores: 600 Control cores: 300	80	PUR-compound, DESINA®-conform
SERVO cables acc. to INDRAMAT Standard INK	Power cables: 20234 Signal cables: 20236	Power cables: 600/1000 Signal cables: 300	80	PUR
SERVO cables acc. to Lenze Standard	Resolver- + Encoder-cables: 2464, 21165 Motor cables: 2570, 20940	Resolver- + Encoder-Signal cables: 300 Motor cables: 600	80	PUR
SERVO cables acc. To SEW Standard	2587	600	80	PVC-compound, DESINA®-conform
SERVO cables acc. to Siemens Standard 6FX 5008	Power cables: 2570 Signal cables: 2502	Power cables: 1000 Signal cables: 30	80	PVC-compound, DESINA®-conform
SERVO cables acc. to Siemens Standard 6FX 7008	20234	1000	80	PVC-compound, DESINA®-conform
SERVO cables acc. to Siemens Standard 6FX 8008	Power cables: 20234 Signal cables: 20236	Power cables: 1000 Signal cables: 30	80	PUR
UNITRONIC® 300	2464	300	105	PVC
UNITRONIC® 300 CY	2464	300	105	PVC
UNITRONIC® LiYCY UL/CSA	2464	300	80	Special-PVC
UNITRONIC® LiYCY(TP) UL/CSA	2464	300	80	Special-PVC
UNITRONIC® LiYY UL/CSA	2464	300	80	Special-PVC
UNITRONIC® BUS ASI (TPE)	2103	300	105	TPE



You can order these articles from our website www.lappgroup.com/advertising

Guide, advisor, reference book

In this book, the reader will find all that is worth knowing about the generation, use, and distribution of electricity, as well as the technology of data communication, cables, control cables, and optic fibres. All of these topics are illustratively described and

supplemented with articles, tables and specialist terminology. This is a book both for trainees and experienced practitioners. It is available in German, English or Russian.

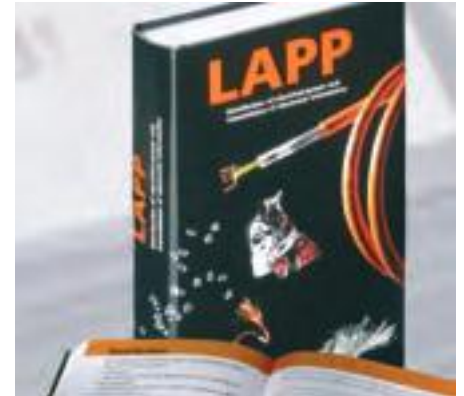

The Lapp Cable Guide

In the "Lapp Cable Guide" you will find many of the technical terms used in the electrical industry. From A as in "absorption" to Z as in "zinc", the terms are listed in alphabetical order and accompanied by a short but concise explanation.

The "Lapp Cable Guide" also contains a large number of useful tables and charts. The English translation is also provided, along with many tables and overviews.



A quick click instead of a long search:

The complete 2009 Product Finder on CD-ROM



Safety

Without exception our products are tested for application safety in accordance with laid down standards and our own regulations, which complement the standards. Relevant legal requirements and safety regulations are also observed. Provided due care and attention is paid, the possibility of product-specific danger to the user may thus reasonably be excluded. Where products are used carelessly or incorrectly, however, considerable

danger to persons and the environment may arise. For this reason, our cables must only be processed and /or used responsibly by trained electricians or specialists. This catalogue contains general information for the application of each product. Independent of such information, the application standards DIN VDE 0298 and DIN VDE 001 for cables will apply. Excerpts from these standards, as well as complementary selection

and application tables, design and installation guidelines, are contained in the tables in the appendix to the main catalogue. Our machines and installation tools are - where necessary - designed in accordance with the machine guidelines and display the CE identification mark. It must be noted, however, that our machines and installation tools must only be used by trained specialized personnel and for the purpose for

which they were designed. ©Copyright by U.I. Lapp GmbH. Reprinting or reproduction of the text or the illustrations may be made only with written approval and with correct indication of source. We reserve the right to make modifications to our products, especially those based on technical improvements or continued development. All illustrations and numerical data etc. are therefore without warranty and are subject to change.

ÖLFLEX®

UNITRONIC®

HITRONIC®

SKINTOP®

SILVYN®

EPIC®

FLEXIMARK®

ETHERLINE®



www.lappgroup.com

To contact your local Lapp Group representative
please visit www.lappgroup.com/worldwide

Terms of Trade:

Our general conditions of sale can be
downloaded from our website
www.lappkabel.de/services