

DIAMOND TOOLING & EQUIPMENT



WORLD DIAMOND SOURCE®

Serving the World's Diamond Tooling Needs

BUILDING RELATIONSHIPS THAT LAST!

SINCE 1995
VOLUME 24

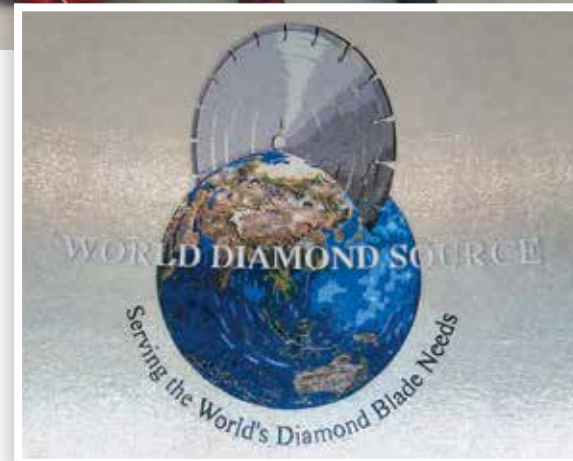

FROM THE DESK OF THE PRESIDENT

The times we are living in are difficult and unprecedented, to say the very least. At World Diamond Source, we strive to meet these new challenges with optimism and perseverance. The stability that we have developed over the past 27 years is invaluable in a time like this. We are very aware that so many industries functionality can be dependent on the tooling that is sourced from us and we take that responsibility very seriously. We work constantly to maintain inventory and keep rising costs down.

As a family founded, owned and operated Company we are grateful for our vast and long-standing customer loyalty. Our commitment is to get through these tough times without compromising our exceptional level of customer service, maintenance of our tried-and-true product lines and new product development and innovation.

World Diamond Source sales teams are expertly trained by industry, and we are always here to assist with product recommendations and technical assistance. We welcome every opportunity to strengthen and BUILD RELATIONSHIPS THAT LAST.

Sincerely,

Clifford J. Maddock
President, World Diamond Source

EXECUTIVE VIEWPOINT

CLIFFORD MADDOCK,
WORLD DIAMOND SOURCE

Meet the North Star of Diamond Tooling Quality and Value



Cliff Maddock
PRESIDENT & CEO, WORLD DIAMOND SOURCE

Cliff Maddock has dedicated his entire career to advancing the concrete cutting, grinding, and polishing industry. At age 17, he landed his first job with a diamond blade firm. His only mode of commuting then was a skateboard. While Cliff's form of transportation has changed since then, his business philosophy remains the same: "Building relationships that last." This simple approach has helped World Diamond Source become a successful family-owned and operated business over the last two decades. Instead of taking a "one blade fits all" method, Cliff and his team constantly innovates by engineering diamond tooling for a specific function and then maintains one of the industry's largest supply for fast customer delivery.

If you cut asphalt, concrete, aggregate, granite, bridge pile, iron pipe, ceramic, porcelain, or other hard material with a diamond saw blade or if you grind and polish concrete, you know the call.

The caller is from a company you've never heard of offering a sweet deal on diamond saw blades. "They're just like the ones from World Diamond Source," or so the well-practiced spiel goes. Veteran diamond blade users know better. It's just another no-name, pop-up company peddling junk blades.

So where does a smart blade buyer go for proven quality, consistency, and savings? There's only one source, *the Source* ... World Diamond Source. Here's what World Diamond Source founder, owner, and president, Clifford (Cliff) Maddock, says to the contractor looking for a reliable diamond blade supplier.

? Some say World Diamond Source is like the North Star in today's diamond saw blade market. What do you say to that?

It's a great compliment. We're a family-owned and operated business and we work hard to win the trust and business of our

customers. It's no secret the marketplace is swarming with no-name companies offering up "deals" on cheap blades. I don't blame some contractors for falling for the pitch.

When I started the company nearly 20 years ago, I swore we'd stick to a simple game plan: Offer top diamond blades at a fair price and then back it with second-to-none service. A lot has changed in those 20 years. But one thing hasn't for our customers. They depend on us to deliver the best dollar per cut value in the industry, backed with terrific support, before and after the sale.

? How do you tell a good diamond blade from a bad one?

Good question. Even I can't tell the difference just by looking. That's why we make it easy and even a little fun by inviting contractors to put our blade to the test entirely at our risk and expense for 30 days. If it kicks you-know-what like I know it will, nine out of 10 contractors will happily pay for it. After all, they've just seen a blade of immense value in action. Like we say, is it better to buy 10 \$100 tools or just three \$250 tools to perform the same job? It's a challenge that's tough to say "no" to.

? Why is World Diamond Source seen as an innovation leader?

It's because we move faster than anyone else out there to advance the state of the art. Take vacuum brazed diamond blades. I won't get into the technology here, but it's a powerful way to cut most anything, rebar, bare metal, ductile iron, you name it. We were the frontrunners in carrying it. Now everyone else is tugging at our coattails over it. We're tremendously nimble and we move lightning fast to jump on innovation and then back it with one of the industry's largest inventories of product. No one compares.

? What do you recommend for next steps?

Visit our website at WorldDiamondSource.com. You'll find great resources along with easy online ordering or a downloadable catalog. Customers like factory-direct pricing backed with outstanding customer service. ●



Website
WorldDiamondSource.com

Phone
800.611.8278

TABLE OF CONTENTS

BLADE BASICS	6-7
How Diamonds are Made	8
Building Relationships that Last	9
Advance Your Business	10
Fast Fact about WDS	11
SIGNATURE SERIES BLADES	SECTION A
Made in America Signature Series	A-3 – A-4
Blue Thunder®	A-5 – A-7
Carnivore®	A-7 – A-8
Super GP®	A-9 – A-10
Power Combo®	A-11 – A-12
Cool Cut™	A-13 – A-14
Omnivore®	A-15 – A-16
Silver Bullet®	A-17 – A-18
Road Runner®	A-19 – A-20
Early Bird®	A-21 – A-22
Block Bear®	A-23 – A-24
Tidal Wave®	A-25 – A-26
HBRX Series™	A-27 – A-28
The Zipper®	A-29 – A-30
SMALL DIAMETER BLADES	SECTION B
Segmented	B-2
Turbo	B-3 – B-4
Segmented Turbo	B-4 – B-5
Continuous Rim	B-4 – B-5
Tuck Point	B-5 – B-6
Crack Chaser	B-7
DIAMOND BLADES FOR TILE AND TUB SAWS	SECTION C
Ceramic Tile	C-2
Marble	C-2
Granite	C-3
Glass Tile/Mosaic	C-2
Porcelain	C-2 – C-3
Brick/Pavers	C-3
Profile Wheels	C-3

SURFACE PREPARATION	SECTION D
Signature Series	D-2 - D-7
Universal Magnetic Plates	D-8 - D-14
Plate Accessories	D-14
Bush Hammers	D-15
PCD Trapezoids	D-16 - D-17
Metal Bond Trapezoids	D-18 - D-21
3" Round Metal Bond	D-21 - D-22
Proprietary Tooling	D-23 - D-28
Grinding & Resin Blocks	D-29
Grinding Heads	D-30
Diamond Plug System	D-31
Floor Polishing	D-32 - D-35
Pro Fiber Diamond Pads	D-36
Signature Series Cup Wheels	D-37
PCD Cup Wheels	D-38
Arrow Cup Wheels	D-39
Cup Wheels	D-40 D-43
Transitional Cup Wheels & Grinding Discs	D-44
Hand Polishing	D-45 - D-47
Cutting Tools	D-48 - D-49
Miscellaneous Accessories	D-50
SDS Max Demo Tools	D-51
WDS® Chemicals	D-52 - D-53
Ameripolish® Architectural Concrete Products	D-54 - D-55
Dustcontrol® - Vacuums & Accessories	D-56 - D-59
Metabo® Surface Prep Tools & Accessories	D-60 - D-68
Universal Dust Shrouds	D-68
Perfect Trac® Saw	D-70
DIAMOND WET WALK-BEHIND BLADES	SECTION E
Concrete	E-3
Asphalt	E-4
Green Concrete	E-4
Asphalt Overlay	E-4
Looping	E-5

DIAMOND WALL SAW BLADES	SECTION F
V-Notch	F-2
Split Segment	F-2
Hydraulic Hand Saw - The Ripper®	F-3
DIAMOND BLADES FOR HAND HELD & MASONRY SAWS	SECTION G
Concrete	G-2 – G-3
Asphalt	G-3 – G-4
Green Concrete	G-3 – G-4
Brick/Hard Materials	G-4 – G-5
Economy DIY	G-4
Block	G-6
General Purpose	G-7 – G-8
Ductile Iron Pipe	G-8
Metal	G-9
Stone	G-9
DIAMOND CORING BITS AND CARBIDE BITS	SECTION H
Core Bit Adapters	H-2
Core Bit Adapters and Accessories	H-2
Wet Application	H-3
Dry Application	H-3
Core Bit Extensions	H-2
SDS PLUS - SDS Max Bits	H-4 – H-5
SPECIALTY BLADES	SECTION I
Omnivore™/Metal	I-2
Rescue/Multi-Purpose	I-2
Ring Saw Blades	I-2
Multi-Cut and Grind	I-3
Carbide Tip	I-3
Joint Clean Out	I-3
Grinder Discs	I-3
Electroplated Form Tools	I-3
Diamond Beaded Wire & Accessories	I-4
Diamond Wire Use & Troubleshoot	I-5

DIAMOND CHAIN & ACCESSORIES	SECTION J
Hydraulic Bars, Chains, Sprockets & Miscellaneous Accessories	J-2 – J-3
DIAMOND PRODUCTS	
Metabo® Demolition Tools / Hammers	J-4 – J-5
WDS The Ripper Saw	J-6
Liquid Cooled Walk Behind Saws	J-7, J-10 – J-13
Electric Hand Held Saw & Light Weight Hydraulic Hand Saws	J-8
Hydraulic Pump Units	J-9
Economy Tile Saw & Super Duty Tile Saw	J-10
Masonry Saw & First-Cut™ Saws	J-12
WEKA® DK12 - Hand Held Core Rig	J-15
Core Rigs	J-16
Heavy Duty Core Rigs	J-14 - J-16
STONE FABRICATION	SECTION K
Bridge Saw Blades	K-2 – K-3
Milling Wheels	K-3
Wet Polishing Pads	K-4 – K-8
Dry Polishers Pads	K-8
Hand Pads	K-8
Backing Pads	K-9
Core Bits for Grinders	K-10
Non-Coring Bits	K-11
Core Bits for Drills	K-11
Curve Cutting Blades	K-12
Electroplated Cutting Blades	K-13
Finger Bits	K-14
Zero Tolerance / Drum Wheels	K-15
Cup Wheels for Grinders	K-16 – K-17
Breaker Bits / Profilers	K-18
Small Diameter Blades	K-19
FLEX PRODUCTS	SECTION L

BLADE BASICS

A diamond blade is a circular steel disc with a diamond bearing edge. The blade edge comes in three main types: segmented, with individual separate segments for long life; turbo, with continuous serrated edge for aggressive, fast cutting; and continuous rim, for smooth chip-free cutting.

The core of the blade is made of tensioned steel and sometimes has slots. These slots (also called gullets) cool the blade by allowing water or air to flow between the segments. They also allow the core to flex and dissipate stress while cutting, so the blade is less likely to crack. All blades are designed to run at specific rpms. It's essential for safe operation and optimum performance that blades run at the correct rpm.

The diamond edge is made of a combination of manufactured diamonds and metal powders. Different mixtures of diamonds and metal powders are used, depending on the aggregate being cut. During the manufacturing process, the metal powder and

diamonds are bonded together at high temperatures to form a solid metal alloy. This metal alloy is then bonded to the blade. A blade's diamond edge is always slightly wider than the core so it doesn't drag or bind in the material being cut.

A diamond blade cuts by grinding through the material. As the diamond edge wears, new and sharper diamonds are exposed.

CHOOSING THE RIGHT BLADE

Answer these simple questions when choosing your blade, or ask your World Diamond Source representative for advice.

- 1 What type of material is being cut?
- 2 Do you want a segmented, turbo or continuous rim blade?
- 3 What is the diameter of the blade?
- 4 Does the rpm of the saw, based on blade diameter, fall within the guidelines?
- 5 Will the blade be used in a wet cutting or dry cutting application?
- 6 Are you more concerned with the initial price or cost effectiveness of blade?

WET BLADES

Wet diamond blades must be used with a continuous flow of water to maximize performance and prevent excessive heat buildup. Water helps clear dust and cuttings away from the blade and slot being cut. Using a wet blade without adequate water, even for a few seconds, can cause blade damage and pose a safety hazard.

DRY BLADES

Dry diamond blades are designed to be cooled by airflow around the blade. They can be used either dry or wet. Note that every 10 to 15 seconds it's necessary to take pressure off the blade and back it out of the cut, allowing it to run back up to full speed for several seconds. This technique cools the blade, maximizes performance and prevents excessive heat buildup that causes damage.

PRODUCT WARRANTY

World Diamond Source warrants all its products against defects in workmanship and materials for a period of one year from the date of purchase. The responsibility of World Diamond Source under this warranty is limited to replacement or repair of the defective parts, and action will be determined on a case-by-case basis. Under no circumstances will World Diamond Source be liable for consequential or incidental damages arising from misuse or improper operation of any products.

SHIPPING POLICY

World Diamond Source pre-pays freight on all orders via United Parcel Service or FedEx - Ground within the United States and Canada. Special service requests, such as next-day air or second-day air, is payable by the customer.

AGGREGATE CLASSIFICATION MAP OF THE UNITED STATES

AGGREGATE MAP FOR U.S.A. & CANADA

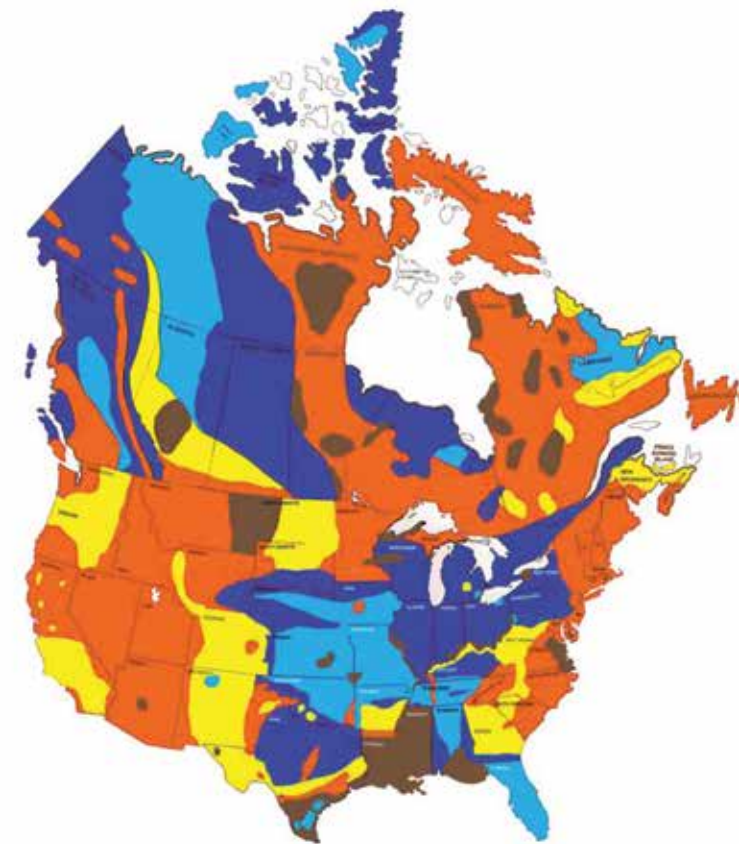

These are the basic aggregates found in shown areas. Other types of aggregates can be found in many parts of the U.S. and Canada.

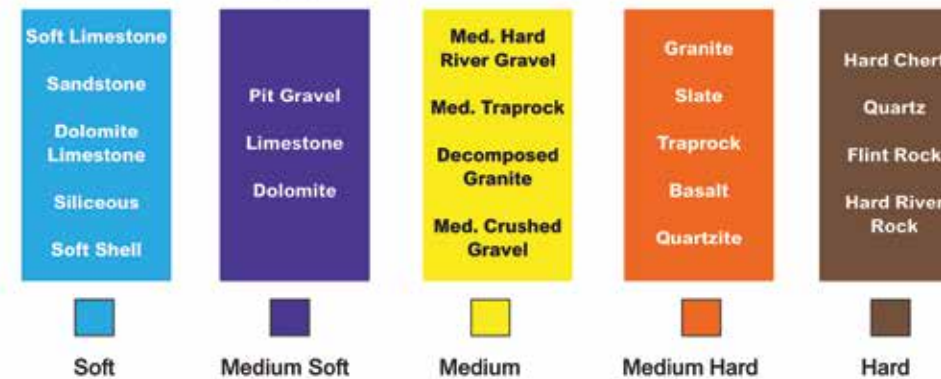

BLADE OPERATING SPEEDS

DIAMETER	RECOMMENDED RPM	MAXIMUM RPM
4"	9072	15000
4 1/2"	8100	13300
5"	7200	12000
6"	6000	10185
7"	5200	8730
8"	4500	7640
9"	4000	6970
10"	3600	6115
12"	3000	6300
14"	3000	5500
16"	2300	3820
18"	2200	3395
20"	2000	3055
22"	1800	2780
24"	1600	2550
26"	1600	2350
28"	1400	2185
30"	1200	2040
32"	1200	1910
36"	1100	1700
42"	900	1455
48"	800	1275

MAXIMUM CUTTING DEPTHS

CONCRETE SAW BLADES		MASONRY SAW BLADES	
DIAMETER	CUTTING DEPTH	DIAMETER	CUTTING DEPTH
12"	3 5/8"	14"	5"
14"	4 5/8"	20"	8"
16"	5 5/8"		
18"	6 5/8"		
20"	7 5/8"		
24"	9 5/8"		
26"	10 5/8"		
30"	11 5/8"		
36"	14 5/8"		
42"	17 5/8"		
48"	19 5/8"		

TILE SAW BLADES		POWER HAND SAW BLADES	
DIAMETER	CUTTING DEPTH	DIAMETER	CUTTING DEPTH
6"	1 3/4"	4"	1"
7"	2 1/4"	4 1/2"	1 1/4"
8"	2 3/4"	5"	1 1/2"
10"	3 3/4"	6"	2"
		7"	2 1/2"
		8"	3"

HOW DIAMONDS ARE MADE

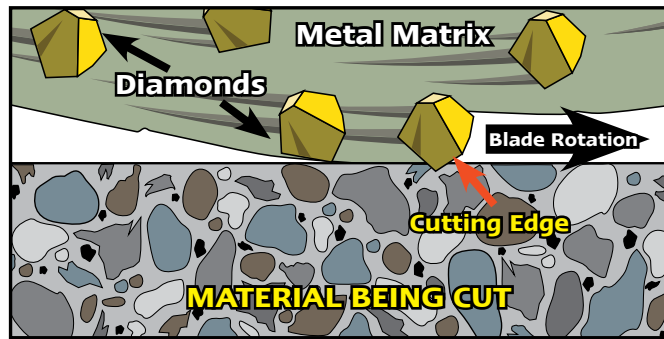

The exposed diamond crystals do the grinding work. The metal matrix or bond holds the diamond in place. Trailing behind each exposed diamond is a bond tail which helps to support the diamond. As the blade rotates through the material, the exposed surface diamonds grind the material.

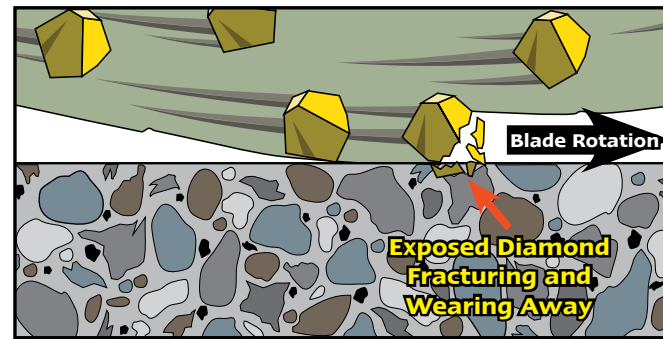

After several thousand passes through the material, the exposed diamonds begin to crack and fracture. The matrix holding the diamonds also begins to wear away.

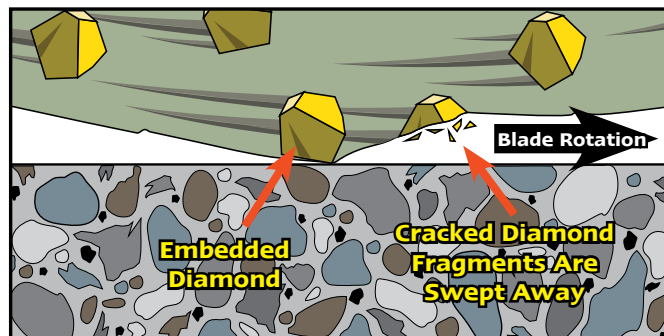

Eventually the diamond completely breaks apart and its fragments are swept away with the material it is grinding. When the blade is cooled with water this material, included with water, produces slurry.

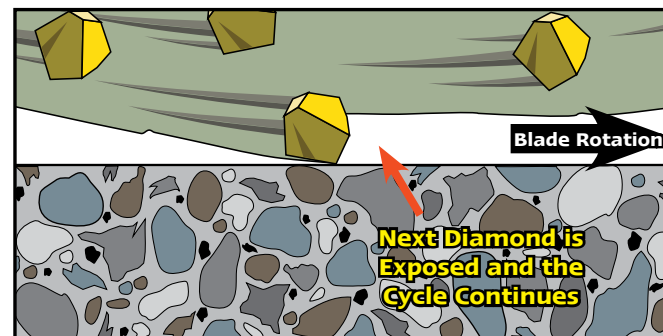

As the old diamonds are fractured and worn away they are replaced by new diamonds and the process continues until the segments are worn down to the core.

#1 Rule for Diamond Blades:

Use a Hard Bond to Cut Something Soft and Use a Soft Bond to Cut Something Hard

DIAMOND QUALITY - YOU GET WHAT YOU PAY FOR



LOW QUALITY SYNTHETIC DIAMONDS

- Weaker crystals with irregular shape
- Shorter life & lower cutting rates
- Lower thermal stability
- Does not handle steel & hard aggregates well
- Jagged points that break causing faster wear & lower cutting & drilling performance
- Widely used in low priced dry products



MEDIUM QUALITY SYNTHETIC DIAMONDS

- Good crystal strength & shape
- Good for sawing & drilling applications
- Good cutting speed
- Handles moderate steel & hard aggregate applications



HIGH QUALITY SYNTHETIC DIAMONDS

- Strongest crystals
- Lasts longer
- Withstands high temperatures
- Octahedral shape for increased tool life & faster cutting
- High impact strength against steel & hard aggregate

TOP 10 REASONS

Building Relationships That Last: Why World Diamond Source Offers the Best Value in Diamond Saw Blades



Rising from the humble origins of a small rented office nearly 20 years ago, family-owned and operated **World Diamond Source** (WDS) is now the industry leader for factory-direct diamond saw blades, core bits, concrete polishing tools, and all other types of diamond tooling. Here are 10 reasons why WDS is the contractors' go-to supplier:

1. Higher Quality = More Value. Performance-minded contractors always look at the cost per cut from their diamond blade. Buying strictly on dollars alone is a false economy. They know it makes no sense to buy 10 \$100 tools when three \$250 tools can get the same job done at 25 percent savings.

2. Factory Direct Pricing. WDS built its business by offering factory-direct savings, cutting overhead on the industry's most comprehensive selection of blades. No one offers a better combination value, service, trust, and savings as WDS.

3. Platinum-Level Customer Service. Contact WDS and you're in touch with a trusted diamond tooling advisor with the expertise you need to get maximum value from your diamond tooling purchase. What are you cutting? What's the task? Our people take the time to understand your needs, offering you the best values in the market.

4. Licensed, Insured Supplier. Why bet your project safety and performance on a questionable supplier? For nearly 20 years, WDS has reduced the cutting costs of more than 25,000 contractors, from sole proprietors to the industry's largest commercial businesses. "Building relationships that last" is more than a WDS company motto. It's how we earn your business.

5. "The Proof Is in the Pudding." Put a WDS blade on your saw for 30 days at our risk. If the WDS blade kicks butt, all we ask is you pay for the blade. It's our way of proving ourselves in the only test that matters, your jobsite. Who else invites you to try before you buy?

6. "OMG" Inventory and Delivery Speed. Why expose your project to needless downtime? The WDS warehouse is packed with nearly \$4 million in blades and surface preparation tooling.

7. Continuous, Relentless R&D. WDS's research and development program is led by the man that also runs WDS, Cliff Maddock. As a family-owned and operated business, Maddock is able to innovate and respond to industry trends on the fly, providing WDS customers with the latest, highest-performing blade technology across all cutting categories.

8. Our Manufacturing Processes. Anyone can copy a WDS blade design. But no one outside of WDS understands the manufacturing process that went into forming that blade. That proprietary process of manufacturing and bonding is a closely-guarded method that differentiates WDS blade performance from poor-performing knock-offs.

9. FREE Catalog. Request your complimentary 116-page copy of the diamond blade cutter's "industry bible." Or view it now online at worlddiamondsource.com. The WDS website is the easy, informative way to order the blades you need.

10. Surface Grinding & Polishing Headquarters. If your task is surface preparation requiring metal bond tooling, backing pads, diamond fiber pads, resin polishing pads, resin polishing pads for hand-held and walk-behind machines, and other materials, count on WDS as your one-stop source.

For more information:

Website WorldDiamondSource.com

Phone **800.611.8278**



Produced by Hanley Wood Strategic Marketing Services Group
sms.hanleywood.com

**CONCRETE
CONSTRUCTION**

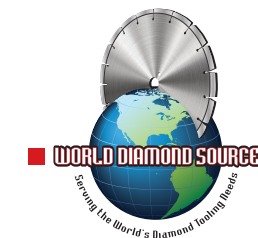

Advance Your Business with Unmatched Diamond Cutting & Grinding Insight



If there was ever an industry where the hard-won lessons learned by one company can help lift the fortunes of another, it's the diamond saw blade and concrete grinding/polishing tool industry.

The central clearing house for this precious know-how is the industry leader, World Diamond Source, the Florida-based innovator, manufacturer, and factory-direct seller of diamond blades and grinding tools for nearly 20 years.

Each year World Diamond Source works with thousands of concrete contractors worldwide, all seeking the most profitable way to cut or grind concrete on projects of every description, from decorative concrete art to multi-billion dollar infrastructure projects. It's a collection of "what works" knowledge without equal in the industry.

Complimentary access to this insight is available to every World Diamond Source customer. Here are several examples of this powerful value-added benefit in action:

Tool Longevity Transforms Job Profitability
Situation: A major concrete floor finisher agreed to test World Diamond Source

grinding tools to see how they compared with the bargain-basement tools they typically bought. World Diamond Source identified the right grinding tools for the job.

Client Reaction: "Wow! World Diamond Source tools last at least two times longer and we're not done yet. I'm on the second job with the same tools. Normally, we use multiple tool sets on the same job. I can't tell you how good your tools really are, because you'll raise my price! [laughing]"

Outcome: The client now "mics" World Diamond Source grinding tools before each job to micro-gauge percent of tool life left from job to job ("one tool + many jobs = more profit").

Custom Engineered Blades Create Profitable New Business

Situation: A decorative concrete contractor engineered a custom saw for specialty work. The saw requires custom blades not available as an off-the-shelf product. World Diamond Source dispatched a blade designer to personally meet with the Massachusetts contractor and determine blade requirements.

Outcome: Other blade manufacturers recommended the contractor reengineer his saw to conform to inventoried blades. The contractor refused to compromise saw design due to blade requirements. Instead, World Diamond Source created new blades on his specs. The blades now help the contractor "kick butt" and advance his business as never before.

World-Famous Freedom Tower Tile Cut with WDS Blades

Situation: Every porcelain tile in the 2.6 million square foot Freedom Tower (One World Trade Center) was cut by a World Diamond Source diamond blade. With up to 75 porcelain saw cutters working simultaneously, it was imperative the blades reduce cost/cut to breakthrough levels.

Outcome: Ordinarily, it would take approximately three years of R&D to "dial-in" the perfect combination of blade speed and life. The large diamond cutting workforce allowed World Diamond Source to compress the dial-in ETA to just three months. The resulting blade—the popular Zipper™ blade—is the gold standard in porcelain cutting.

Why risk your income, safety, and reputation on junk blades or grinding tools from no-name suppliers? For no additional cost, World Diamond Source offers you the same unmatched expertise and factory-direct pricing thousands of professionals worldwide trust every business day. ●

For More Information

Website WorldDiamondSource.com
Phone 800.611.8278

Fast Facts about World Diamond Source



Frequently Asked Questions

What is World Diamond Source?

World Diamond Source (WDS) is the world's premier supplier of diamond saw blades, core bits, and concrete polishing and grinding tools for professional contractors.

Why is WDS the premier supplier?

Three big reasons:

- 1. Unmatched Quality.** As an industry pioneer and leading diamond tooling innovator, WDS sets the bar on quality and value. WDS maintains exclusive relationships with top overseas factories and is the developer of multiple proprietary manufacturing processes, ensuring no one can match WDS' cost per cut, the true measure of diamond saw blade value.
- 2. Factory-Direct, Low-Overhead Prices.** WDS' commitment to superior value is reflected in the company's easy, direct-selling process. Whether online or by phone, WDS makes it easy to order as few or as many blades as you need, with next business day service available.
- 3. Platinum-Level Customer Service.** WDS experts are at your service with trusted advice on the best blade for your needs and budget. "Building Relationships That Last" is the WDS motto, and means there is no better way to win your business than by earning it the old fashioned way with outstanding products, value, and service.

Is it easy to do business with WDS?

Absolutely. For details and pictures of nearly 2,500 diamond saw blades, core bits, and concrete polishing and grinding tools, visit WorldDiamondSource.com, where you can order online or download WDS' 116-page catalog (printed version available on request.) WDS offers the industry's most comprehensive selection of diamond saw blades and the friendly, expert team ready to support your project needs.

For More Information

Website WorldDiamondSource.com
Phone 800.611.8278

What's the Best Diamond Saw Blade for Your Application?

Matching up just the right diamond saw blade for your application is a careful process at World Diamond Source. For example, WDS carries no fewer than 15 different 14-inch blades. Which one is exactly right for you? Our expert customer support team works with you to meet your project requirements, including fact-finding on:

- Initial price of blade or cost per cut of the blade
- Matching saw and horsepower to blade being used
- Type of material being cut
- Segmented, serrated or continuous rim blade
- Wet-cutting or dry-cutting application

With nearly 2,500 SKU's in stock to choose from, count on your WDS Customer Service Professional to work with you to identify the options of exceptional value.

What Fellow Contractors Say About World Diamond Source

"World Diamond Source has the best quality of product and more knowledge on our needs than anyone we have worked with."

Mason—15 Year Customer
Scottsdale, Ariz.

"World Diamond Source is our partner and we would not go anywhere else for diamond blades."

General Contractor—17 Year Customer
Long Island City, N.Y.

"The first time I bought 12-inch and 14-inch blades from World Diamond Source because of price. The second time I bought because of the quality. Now I buy all my blades from World Diamond Source."

Utility Contractor—8 Year Customer
Camp Hill, Pa.



SIGNATURE SERIES

SECTION A





MADE IN USA

SIGNATURE SERIES

SIGNATURE SERIES MADE IN AMERICA

These blades are all proudly made right here in the United States of America and all bare the MADE IS USA logo stamped right on each core.

- Double Laser Welded For Strength and Safety
- Available in 2 segment styles for Maximum Speed and Life
- Segmented for LIFE and durability
- Segment Turbo for SPEED and increased productivity
- Available in 2 bonds to optimize performance in hard and soft materials
- Soft Bond for Hard materials / more speed
- Hard Bond for GP cutting/ more life
- Heavy-Duty Tension Steel Core for durability and no wobble
- .125 Thick Core for strength and professional use
- JUMBO 12mm Tall segment height for extended LIFE
- Available in universal 1"/20mm and straight 20mm arbor sizes

PREMIUM – SEGMENTED 12mm JUMBO segment height

Soft Bond

12" x .125 x 1" / 20mm	DCL12-D
14" x .125 x 1" / 20mm	DCL14-D
14" x .125 x 20mm	DCL14-D/20
16" x .125 x 1" / 20mm	DCL16-D
16" x .125 x 1" / 20mm	DCL16-D/20

Hard Bond

14" x .125 x 1" / 20mm	DCLH14-D
14" x .125 x 20mm	DCLH14-D/20
16" x .125 x 1" / 20mm	DCLH16-D

PREMIUM – SEGMENTED TURBO 15mm JUMBO segment height

Soft Bond

14" x .125 x 1" / 20mm	ST14-7B
14" x .125 x 20mm	ST14-7B/20
16" x .125 x 1" / 20mm	ST16-7B

Hard Bond

14" x .125 x 1" / 20mm	STH14-7B
14" x .125 x 20mm	STH14H-7B/20
16" x .125 x 1" / 20mm	STH16-7B



All of our Aluminum Universal Magnetic Plates on pages 52-54 are all hand made in the USA. Each plate is PROUDLY made from USA made Aluminum and cut and hand crafted here in our home town of Pompano Beach Florida for precision tolerances and attention to every detail to ensure proper fit on all grinding machines.

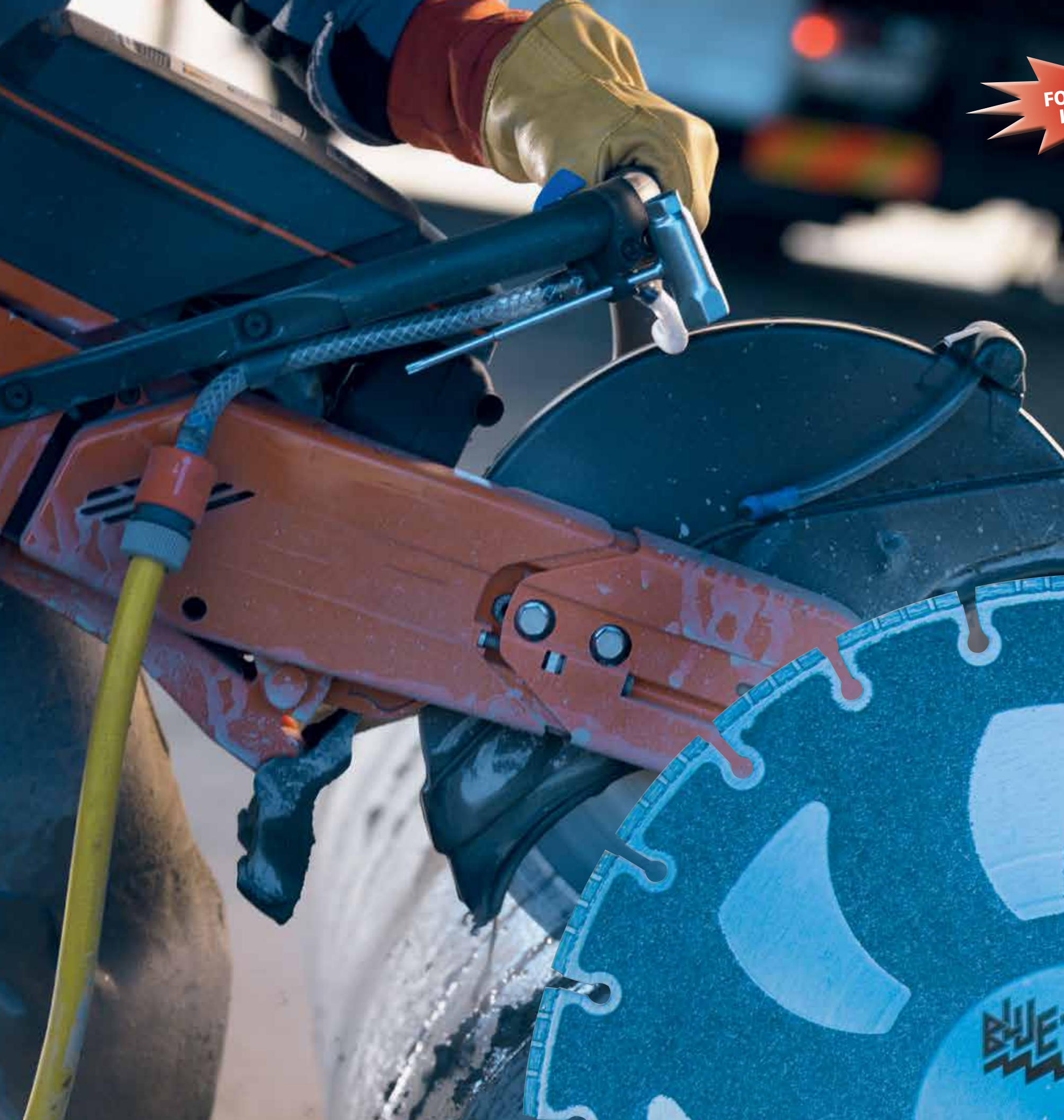

**FOR DUCTILE
IRON PIPE**

SIGNATURE SERIES **BLUE THUNDER®**

Our Blue Thunder® was the first high performance ductile blade ever made. It has been often imitated but never duplicated. There is not a faster-cutting, longer-lasting ductile blade on the market.

- For ductile iron pipe
- Cobalt-infused core dissipates heat for longer life
- Thicker core eliminates wobble
- Abrasive side panels bevel cuts
- 2-3 times the speed of any abrasive wheel
- Double laser welded for safety
- Dry/Wet
- Pro Series

SIGNATURE SERIES

12" x .125" x 1"	PDI 12-7B
12" x .125" x 20mm	PDI 12-7B/20
14" x .125" x 1"	PDI 14-7B
14" x .125" x 20mm	PDI 14-7B/20
16" x .125" x 1"	PDI 16-7B
16" x .125" x 20mm	PDI 16-7B/20

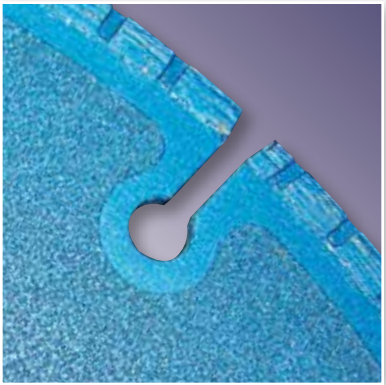

SIGNATURE SERIES

SIGNATURE SERIES **CARNIVORE®**

Our Carnivore® is the newest addition to our line. It has a special segment design for super-fast cuts, a special core for cooling and a special bond that gives you long life in any application, with the ultimate cutting speed.

- Contractor's dream—cut RCP, block, culverts, brick, pavers, concrete, asphalt
- N-shaped speed-notch segment for instant speed
- Added segment cooling for longer life
- Unique slot design, added holes in core for cooling, extended life
- Won't warp or wobble in high PSI materials
- Double laser welds for safety
- Most durable, versatile multi-purpose blade
- .125" thickness eliminates wobble
- Undercut protection cuts through sub-base
- Pro Series
- .320" segment height
- Dry/Wet

12" x .125" x 1"	CNC12-1
12" x .125" x 20mm	CNC12-1/20
14" x .125" x 1"	CNC14-1
14" x .125" x 20mm	CNC14-1/20
16" x .125" x 1"	CNC16-1

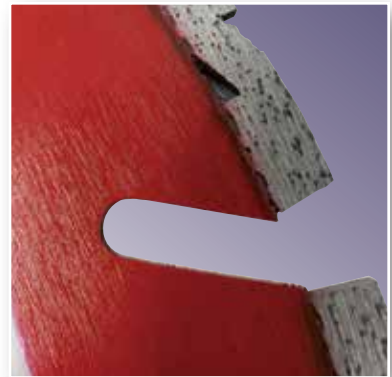

THE
CARNIVORE



**EXTREME
LIFE**

SIGNATURE SERIES **SUPER GP®**

Super General Purpose, the first and original true general purpose blade. This blade will actually live up to its name "Super GP®." Expect extremely long life and speed of cut in all applications. If you are using one blade for all of your cutting applications, this is the blade for you. Accept no imitations!

- First true combination concrete/asphalt/green concrete blade
- Blade is idiot-proof—one blade cuts all
- Undercut protection cuts through sub-base
- .125" thickness eliminates wobble
- Double laser welded for safety
- Longest-lasting general purpose blade available
- Pro Series
- .320" segment height
- Dry/Wet

SIGNATURE SERIES

12" x .125" x 1"	SGP12-1
12" x .125" x 20mm	SGP12-1/20
14" x .125" x 1"	SGP14-1
14" x .125" x 20mm	SGP14-1/20
16" x .125" x 1"	SGP16-1
18" x .125" x 1"	SGP18-1

SUPER GP - JR.
General Purpose, Dry/Wet

12" x .125" x 1"	SGPJ12-1
14" x .125" x 1"	SGPJ14-1
14" x .125" x 20mm	SGPJ14-1/20

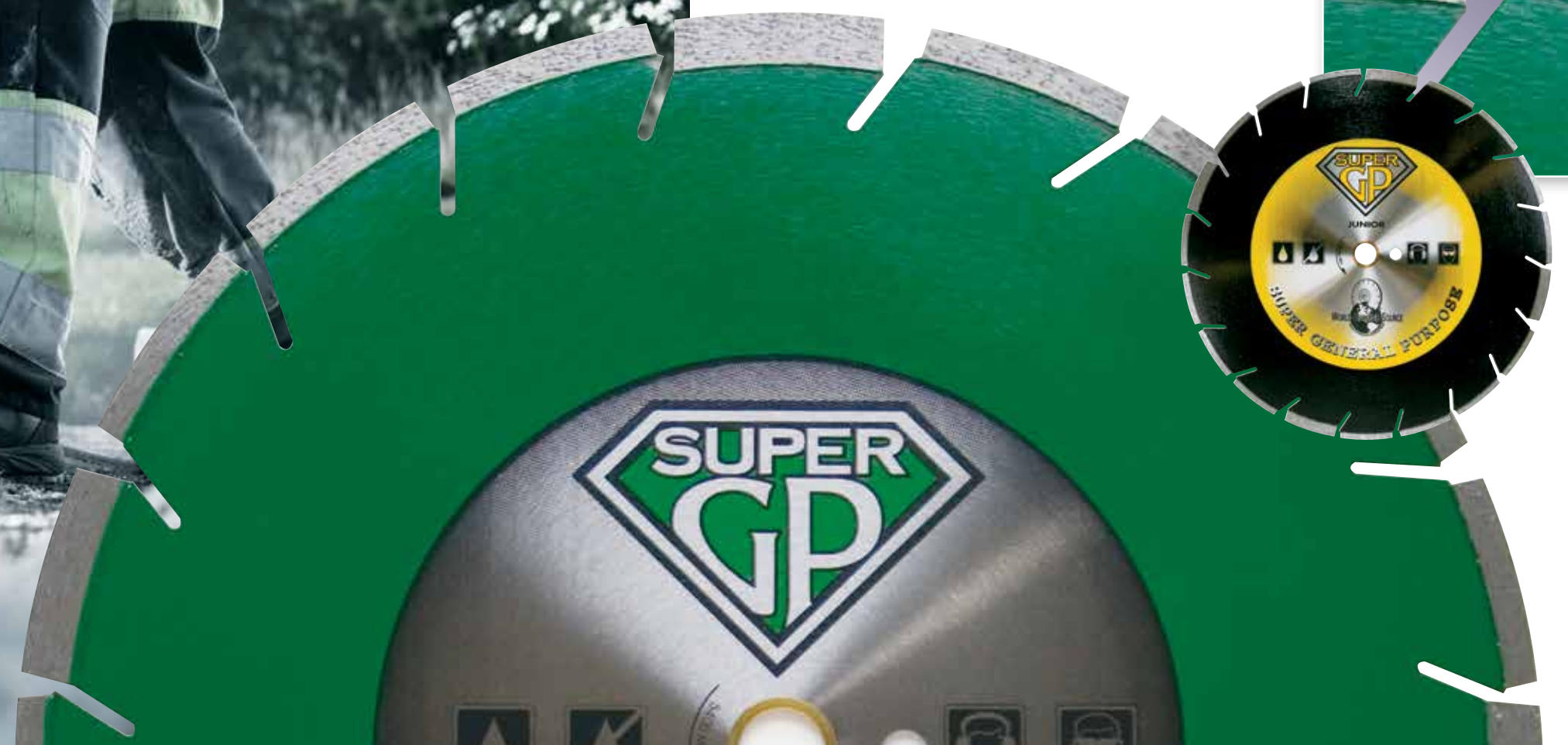



SIGNATURE SERIES

SIGNATURE SERIES **POWER COMBO®**

Our Power Combo® blades are the best performing general purpose blades you can buy. Their unique keyhole slot and jumbo wave segment design promote a longer life than ordinary blades.

- Available in GP, GPS and GPX Series for different applications
- GP/GPX: brick, block, pavers, cured and green concrete
- GPS: high PSI brick and pavers, ductile iron pipe, concrete and concrete pipe
- .125" thickness eliminates wobble
- Double laser welded for safety
- Bonds have 16+ years of proven field performance
- Dry/Wet

GP PREMIUM

12" x .125" x 1"	GP12-1
12" x .125" x 20mm	GP12-1/20
14" x .125" x 1"	GP14-1
14" x .125" x 20mm	GP14-1/20
16" x .125" x 1"	GP16-1

GPS PREMIUM SOFT BOND

12" x .125" x 1"	GPS12-1
12" x .125" x 20mm	GPS12-1/20
14" x .125" x 1"	GPS14-1
14" x .125" x 20mm	GPS14-1/20
16" x .125" x 1"	GPS16-1





SIGNATURE SERIES

SIGNATURE SERIES COOL CUT®

Our specially formulated Cool Cut® concrete blade, with its unique segment design, will outperform any cured concrete blade on the market.

- New, improved version of flagship concrete blade
- Available in DC, DCU and DCUX Series for different applications
- Specially shaped segments for cooling effect, extended life, speed of cut
- Double laser welded for safety
- Dry/Wet

PREMIUM .320" segment height

12" x .125" x 1"	DC12-1
12" x .125" x 20mm	DC12-1/20
14" x .125" x 1"	DC14-1
14" x .125" x 20mm	DC14-1/20
16" X .125" x 1"	DC16-1
18" x .125" x 1"	DC18-1
20" x .125" x 1"	DC20-1

ULTRA SUPREME .380" segment height

14" x .125" x 1"	DCUX14-1
16" x .125" x 1"	DCUX16-1

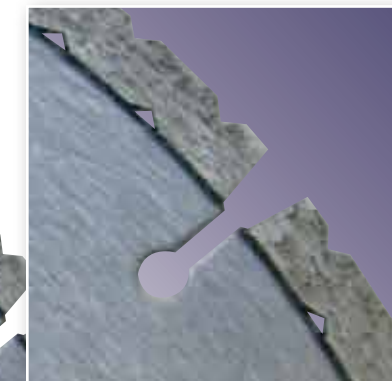



**OUR MOST
VERSATILE BLADE!**

SIGNATURE SERIES **OMNIVORE®**

The Omnivore® is the first diamond blade that cuts raw metal and steel. In fact, it's the only diamond blade that cuts everything and does it up to 4 times faster than a conventional abrasive blade. The Omnivore® is also very cost effective, it outlasts 30 to 50 abrasive wheels to 1, and eliminates the associated down time and labor cost of changing each blade.

The Omnivore is designed to cut:

- Steel
- Concrete
- Plastic
- Cast Iron
- HDPE & C900
- Ductile Iron
- Rebar
- PVC
- Angle Iron
- Steel Deck Pans
- Bridge Deck
- Polyethylene Pipes

Also Cuts:

- Roof Tile
- Dry Wall
- Masonry
- Stainless Steel
- Tile Backer Board
- Stucco

- Eliminates downtime changing abrasive wheels
- Maintains consistent depth throughout cutting life
- Available in 4, 4½, 5", 6", 7", 8", 9, 10, 12", 14", 16"
- Dry/Wet

SIGNATURE SERIES

4" x .080" x 7/8-5/8"	VBS4-7B
4½" x .080" x 7/8-5/8"	VBS4.5-7B
4½" x .050" x 7/8-5/8"	VB4.5-7B
5" x .080" x 7/8-5/8"	VBS5-7B
6" x .080" x 7/8-5/8"	VBS6-7B
6" x .050" x 7/8-5/8"	VB6-7B
7" x .095" x universal	VBS7-7B
7" x .060" x 7/8-5/8"	VB7-7B
8" x .095" x universal	VBS8-7B
9" x .095" x 7/8-5/8"	VBS9-7B
10" x .095" x 1" - 7/8-5/8"	VBS10-7B
12" x .125" x 1"	VBS12-7B
12" x .125" x 20mm	VBS12-7B/20
14" x .125" x 1"	VBS14-7B
14" x .125" x 20mm	VBS14-7B/20
16" x .125" x 1"	VBSC16-7B

W / SIDE PROTECTION	
12" x .125" x 1"	VBSSC12-7B
12" x .125" x 20mm	VBSSC12-7B/20
14" x .125" x 1"	VBSSC14-7B
14" x .125" x 20mm	VBSSC14-7B/20
16" x .125" x 1"	VBSSC16-7B





SUPER FAST CUT!

SIGNATURE SERIES **SILVER BULLET®**

Our Silver Bullet® hasn't changed in over 18+ years. It hasn't needed to! This bond, with 90% cobalt matrix, always does the job. Hands down the fastest cutting pipe and hard material blade we have ever manufactured.

- Serrated turbo segment for faster cuts in hard materials
- Segmented design for long life
- 10mm segments double laser welded for safety
- 18+ years of proven field performance
- .125" thickness eliminates wobble
- Double laser welded for safety
- Pro Series
- Dry/Wet

SIGNATURE SERIES

4" x .080" x 7/8" - 5/8"	ST4-1
4 1/2" x .085" x 7/8" - 5/8"	ST4.5-1
5" x .080" x 7/8" - 5/8"	ST5-1
7" x .080" x 7/8" - 5/8"	ST7-1
8" x .080" x 7/8" - 5/8"	ST8-1
10" x .100" 1" x 7/8" - 5/8"	ST10-1
12" x .125" x 1"	ST12-1
12" x .125" x 20mm	ST12-1/20
14" x .125" x 1"	ST14-1
14" x .125" x 20mm	ST14-1/20
16" x .125" x 1"	ST16-1
16" x .125" x 20mm	ST16-1/20
18" x .125" x 1"	ST18-1
20" x .125" x 1"	ST20-1



SIGNATURE SERIES

SIGNATURE SERIES ROAD RUNNER®

Our Road Runner® is asphalt's worst enemy! You can't go wrong. The road can't run from this blade.

- Asphalt's worst enemy
- Available in DAG, DAGP and DAGX Series for different applications
- .440" dropped segment for undercut protection
- Wide gullets scoop away abrasive slurry from cuts
- Double laser welded for safety
- .125" thickness eliminates wobble
- Dry/Wet

PREMIUM .320" segment height

12" x .125" x 1"	DAG12-1
12" x .125" x 20mm	DAG12-1/20
14" x .125" x 1"	DAG14-1
14" x .125" x 20mm	DAG14-1/20
16" x .125" x 1"	DAG16-1
18" x .125" x 1"	DAG18-1
20" x .125" x 1"	DAG20-1

PROFESSIONAL .350" segment height

12" x .125" x 1"	DAGP12-1
12" x .125" x 20mm	DAGP12-1/20
14" x .125" x 1"	DAGP14-1
14" x .125" x 20mm	DAGP14-1/20
16" x .125" x 1"	DAGP16-1

ULTRA SUPREME .380" segment height

14" x .125" x 1"	DAGX14-1
------------------	----------

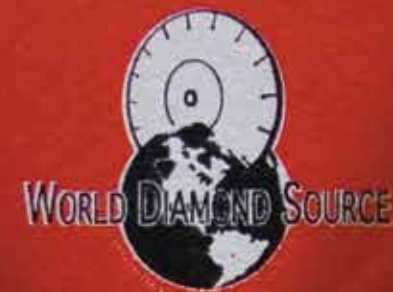
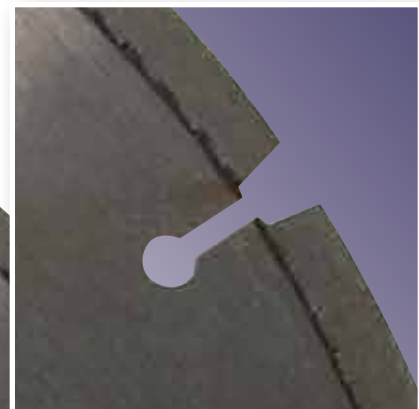

SKID PLATES



SKID Plate for 5"	SKP09
SKID Plate for 5.5"	SKP10
Small Metal SKID Plate for 6" & 8"	SKP01
Small Metal SKID Plate for 6" & 8" Stainless Steel	SKP01N
Small Metal SKID Plate for 6" & 8" x .250"	SKP01-10
Medium Metal SKID Plate for 10"	SKP02
Medium Metal SKID Plate for 10" x .250"	SKP02-10
Large Metal SKID Plate for 12"/13.5" x .125"	SKP03
Large Metal SKID Plate for 12"/13.5" x .125" Stainless Steel	SKP03N
Large Metal SKID Plate for 12"/13.5" x .125" for Thin Blades	SKP03-THIN
Large Metal SKID Plate for 12"/13.5" x .125" w/ Tabs	SKP03T
Large Metal SKID Plate for 12"/13.5" x .187"	SKP03-7
Large Metal SKID Plate for 12"/13.5" x .250"	SKP04
Large Metal SKID Plate for .375" 12"/13.5" 14"	SKP05
Large Metal SKID Plate for .500" 12"/13.5" 14"	SKP06
Extra Large Metal SKID Plate for .500" x .125"	SKP07
Extra Large Metal SKID Plate for .500" x .250"	SKP08



SIGNATURE SERIES EARLY BIRD®



SIGNATURE SERIES

Our Early Bird® Series green concrete blades can be used on all grinders, skill saws, hand held, walk-behind, and early entry saws. We have bonds for all different aggregates when sawing green concrete.

- CUT WITHIN 1 to 2 HOURS
The GREEN ZONE™
- Fits all SOFF-CUT® early entry saws without adapters
- Improved METAL Skid Plates For EXTENDED LIFE
- No plastic sleeves
Real Metal Skid Plates
- Available Sizes: 5" / 5.5" / 6" / 8" / 10" / 12" / 13.5" / 14"
- Available in color coded bonds for all aggregates

WDS Early Bird®	Soff-Cut® Bonds	
PURPLE	PURPLE	SOFTEST BOND ↑ ↓ HARDEST BOND
GREEN	GREEN	
RED	RED	
ORANGE	ORANGE	
YELLOW	YELLOW	
BLACK	BLACK	

4" x .095" x 7/8" - 5/8"	GC4-1
4 1/2" x .095" x 7/8" - 5/8"	GC4.5-1
5" x .095" x SCT (medium bond)	GCM5-1
5 1/2" x .095" x SCT (medium bond)	GCM5.5-1
6" x .100" x SCT (x-soft bond)	GCS6-1
6" x .100" x SCT (soft bond)	GCS6-1
6" x .100" x SCT (medium bond)	GCM6-1
6" x .225" x SCT (medium bond)	GCM6-2
6" x .100" x SCT (hard bond)	GCH6-1
7" x .100" x DM-5/8"	GC7-1
8" x .100" x 7/8" - 1" w/P.H.	GC8-1
8" x .100" x SCT (x-soft bond)	GCS8-1
8" x .100" x SCT (soft bond)	GCS8-1
8" x .100" x SCT (medium bond)	GCM8-1
8" x .100" x SCT (hard bond)	GCH8-1
9" x .100" x 7/8" - 5/8"	GC9-1
10" x .100" x 1" - 7/8" - 5/8"	GC10-1
10" x .100" x SCT (x-soft bond)	GCS10-1
10" x .100" x SCT (soft bond)	GCS10-1
10" x .100" x SCT (medium bond)	GCM10-1
10" x .100" x SCT (hard bond)	GCH10-1
12" x .120" x SCT (x-soft bond)	GCS12-1
12" x .120" x SCT (soft bond)	GCS12-1
12" x .125" x 1" - SCT - SUPER PRO	SGC12-SUPER
12" x .120" x SCT (medium bond)	GCM12-1
12" x .250" x SCT (medium bond)	GCM12-2
12" x .120" x SCT (hard bond)	GCH12-1
13 1/2" x .120" x SCT (x-soft bond)	GCSX13.5-1
13 1/2" x .120" x SCT (soft bond)	GCS13.5-1
13 1/2" x .120" x SCT (medium bond)	GCM13.5-1
13 1/2" x .125" x 1" x SCT - SUPER	GCM13.5-SUPER
13 1/2" x .120" x SCT (hard bond)	GCH13.5-1
13 1/2" x .187" x SCT (medium bond)	GCM13.5-7
13 1/2" x .250" x SCT (x-soft bond)	GCS13.5-2
13 1/2" x .250" x SCT (medium bond)	GCM13.5-2
14" x .125" x 1" - SCT - SUPER PRO	SGC14-SUPER

* SCT = Manufactured Soff-Cut® triangle arbor

MANUFACTURED TRIANGLE ARBOR,
so blades fit directly on your Soff-Cut®
saws with NO ADAPTERS



**SILENT CORES
NOW IN STOCK!**

SIGNATURE SERIES

SIGNATURE SERIES **BLOCK BEAR®**

Block Bear® lives up to its name when cutting all types of block. Use it on all large table saws to cut block in one pass without flipping over. Available in different specs and bonds or all different applications.

STANDARD - .380 Segment Height

- BP - General Purpose Bond

PROFESSIONAL - .320 Segment Height

- BPM - Soft / Medium Bond
- BP - Hard Bond

SUPER PROFESSIONAL - .380 Segment Height

- BXM - Soft / Medium Bond
- BX - Hard Bond

STANDARD

20" x .140" x 1"	BX20-4N
------------------	----------------

PROFESSIONAL

20" x .125" x 1"	BP20-1
20" x .125" x 1"	BPM20-1

SUPER PROFESSIONAL

20" x .140" x 1"	BXM20-1
20" x .140" x 1"	BX20-1

SILENT PRO

14" x .125" x 1"	SBX14-1
20" x .140" x 1"	SBX20-1



WORLD DIAMOND SOURCE®



SIGNATURE SERIES

SIGNATURE SERIES **TIDAL WAVE®**

Tidal Wave® is a great choice for hand held or table saws to cut pavers and brick if speed is what's important to you. Hard materials are no match for this blade.

- New wave-shaped segment for instant speed of cut
- Double-tensioned steel core prevents wobbling on high HP saws
- Staggered turbo segments for slicing effect, unparalleled speed
- 10mm jumbo segments
- Double laser welded for safety
- .125" thickness eliminates wobble
- Pro Series
- Dry/Wet

12" x .125" x 1"	WST12-7B
12" x .125" x 20mm	WST12-7B/20
14" x .125" x 1"	WST14-7B
14" x .125" x 20mm	WST14-7B/20





**FOR EXTREMELY
HARD BRICK**

SIGNATURE SERIES

SIGNATURE SERIES **HBRX SERIES™**

HBRX Series™ blades are the #1 blade in the industry for cutting extremely hard brick and materials. They feature uniquely designed wide gullets for cooling. The specially designed super-soft bond is made with the highest grade of diamond available, providing exceptionally fast and smooth cutting.

- Hard brick, high PSI materials
- 10mm jumbo segments yield 30% longer life
- Double laser welded construction for extra strength
- .125" thickness eliminates wobble
- Pro Series
- Dry/Wet

12" x .125" x 1"	HBRX12-1
14" x .125" x 1"	HBRX14-1
14" x .125" x 1"	STHBRX14-1
16" x .125" x 1"	HBRX16-1
18" x .125" x 1"	HBRX18-1
20" x .125" x 1"	HBRX20-1



SIGNATURE SERIES

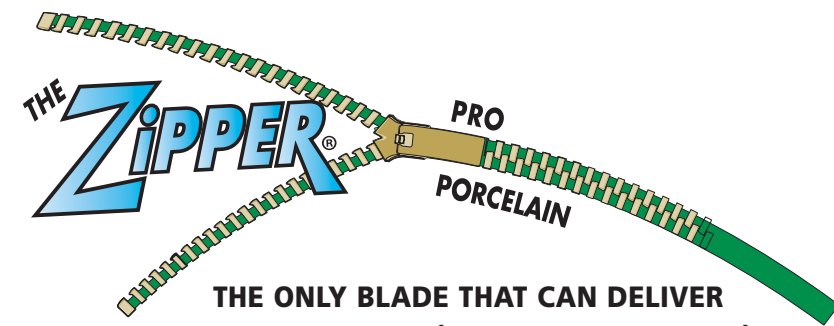

THE ONLY BLADE THAT CAN DELIVER A FACTORY EDGE (ON HARD PORCELAIN) WITH EVERY CUT!!!

SIGNATURE SERIES THE ZIPPER® BLADES

Our FLAGSHIP Signature Series Porcelain/Granite blade for hard materials. This line of Premium and Pro quality dry cutting diamond blades are designed for cutting porcelain, ceramic, granite, engineered stone, marble, and other hard materials fast and with a clean factory edge. Available in 2 styles with 2 quality options. The Zipper® blade will cut the mentioned materials cleaner, smoother, and with twice the speed of any other turbo or continuous rim blade on the market today! This is the only blade that can deliver a factory edge on hard porcelain with every cut!

Available in: 4" / 4.5" / 5" / 7" / 8" / 10" / 12" / 14"

Application: Porcelain, Granite, Travertine, Glazed Ceramics, Engineered Stone, Pavers, and More.

- Ultra-Thin Rim = Clean Cut
- Turbo Style Segment = Fast Aggressive Cuts
- Cobalt Core with Cooling Holes = Long Life
- Titanium Coated Diamonds = Extended Life
- Laser welded for safety and durability
- .125 Reinforced core for no flex and consistent straight cuts
- These blades are designed for wet or dry cutting
- Produces a factory edge on hard materials
- Our #1 Selling blade for the Tile Industry

THE ZIPPER® BLADE

PORCELAIN – PRO SERIES

Dry/Wet, Heavy Flange for No Blade Flex, Turbo Rim for Aggressive Cuts, Extra Thin Rim for Perfectly Clean Cuts. Pro Grade.

4" x 7/8" - 20mm - 5/8"	PT4-H
4 1/2" x 7/8" - 20mm - 5/8"	PT4.5-H
5" x 7/8" - 20mm - 5/8"	PT5-H
7" x DM - 5/8"	PT7-H
8" x DM - 5/8"	PT8-H
10" x 1" - 5/8"	PT10-H
12" x 1" - 60mm - 50mm - 1"	PT12-H
14" x 1" - 60mm - 50mm - 1"	PT14-H

THE RED ZIPPER® BLADE

PORCELAIN – PRO SERIES

Dry/Wet, Heavy Flange for No Blade Flex, Turbo Mesh Style Segment reduces heat and friction to minimize glazing. Same bond as The Zipper® Blade for clean, chip-free cuts through porcelain, ceramic, and stone. Pro Grade.

4" x 7/8" - 20mm - 5/8"	RPT4-H
4 1/2" x 7/8" - 20mm - 5/8"	RPT4.5-H
5" x 7/8" - 20mm - 5/8"	RPT5-H
7" x DM - 5/8"	RPT7-H
10" x 1" - 5/8"	RPT10-H

THE BLUE ZIPPER® BLADE

PORCELAIN – PREMIUM SERIES

Dry/Wet, Heavy Flange for No Blade Flex, Turbo Rim for Aggressive Cuts, Extra Thin Rim for Perfectly Clean Cuts. Premium Grade.

4" x 7/8" - 20mm - 5/8"	PZ4-B
4 1/2" x 7/8" - 20mm - 5/8"	PZ4.5-B
5" x 7/8" - 20mm - 5/8"	PZ5-B
7" x DM - 5/8"	PZ7-B
8" x DM - 5/8"	PZ8-B
10" x 1" - 5/8"	PZ10-B
12" x 1" - 60mm - 50mm - 1"	PZ12-B

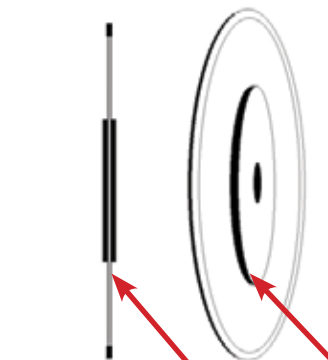

.050 Edge w/ .125 Reinforced Core

SMALL DIAMETER BLADES

SECTION B

Our small diameter blades are designed to cut a variety of surfaces and work especially well on all types of materials. Try to match the quality of the blade to the job. A smaller job may only require a heavy-duty blade. On a larger job you may want a premium blade or a more cost effective blade. We have many sizes, grades and types for every application possible. If you require any assistance, our knowledgeable staff will gladly help match the appropriate blade to your needs.



SMALL DIAMETER BLADES



THE EARLY BIRD GETS THE WORM



SMALL DIAMETER BLADES

SEGMENTED BLADES

Segmented blades are most common because of their versatility and wide scope of applications. They are a good choice if longer life is what's important to you.

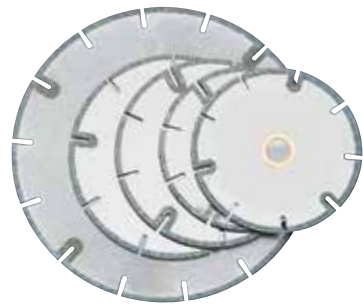

PRO ELECTROPLATED
Segmented, Dry/Wet

4" x .080" x 7/8" - 5/8"	E4-1
4 1/2" x .080" x 7/8" - 5/8"	E4.5-1
5" x .080" x 7/8" - 5/8"	E5-1
7" x .080" x DM - 5/8"	E7-1



POWER COMBO® GPS (SOFT BOND)
GENERAL PURPOSE
Laser Welded, Dry/Wet

4" x .080" x 7/8" - 5/8"	SP4-5Q
4 1/2" x .080" x 7/8" - 5/8"	SP4.5-5Q
5" x .080" x 7/8" - 5/8"	SP5-5Q
6" x .080" x 7/8" - 5/8"	SP6-5Q
7" x .080" x DM - 5/8"	SP7-5Q
8" x .080" x DM - 5/8"	SP8-5Q
9" x .080" x 7/8" - 5/8"	SP9-5Q
10" x .080" x 7/8" - 5/8"	SP10-5Q

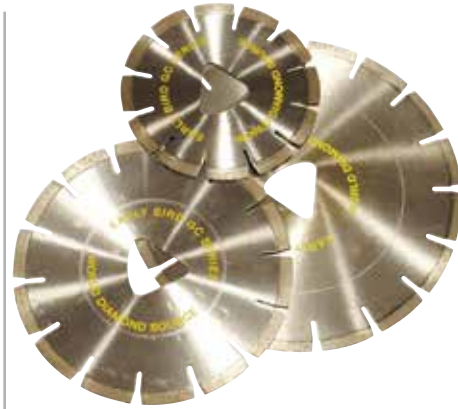

GREEN CONCRETE
EARLY BIRD™ PRO SERIES SUPREME
Laser Welded, Dry/Wet

4" x .095" x 7/8" - 5/8"	GC4-1
4 1/2" x .095" x 7/8" - 5/8"	GC4.5-1
5" x .095" x SCT (Medium bond)	GCM5-1
5 1/2" x .095" x SCT (Medium bond)	GCM5.5-1
6" x .100" x SCT (x-soft bond)	GCS6-1
6" x .100" x SCT (soft bond)	GCS6-1
6" x .100" x SCT (medium bond)	GCM6-1
6" x .225" x SCT (medium bond)	GCM6-2
6" x .100" x SCT (hard bond)	GCH6-1
7" x .100" x DM - 5/8"	GC7-1
8" x .100" x 7/8" - 1" w/P.H.	GC8-1
8" x .100" x SCT (x-soft bond)	GCS8-1
8" x .100" x SCT (soft bond)	GCS8-1
8" x .100" x SCT (medium bond)	GCM8-1
8" x .100" x SCT (hard bond)	GCH8-1
9" x .100" x 7/8" - 5/8"	GC9-1
10" x .100" x 7/8" - 5/8"	GC10-1
10" x .100" x SCT (x-soft bond)	GCS10-1
10" x .100" x SCT (soft bond)	GCS10-1
10" x .100" x SCT (medium bond)	GCM10-1
10" x .100" x SCT (hard bond)	GCH10-1

* SCT = Manufactured Soff-Cut® triangle arbor



PREMIUM—GENERAL PURPOSE
Silver Welded, Dry/Wet,
10mm Segment Height

4" x .080" x 7/8" - 5/8"	SX4-4N
4 1/2" x .080" x 7/8" - 5/8"	SX4.5-4N
5" x .080" x 7/8" - 5/8"	SX5-4N
6" x .090" x 7/8" - 5/8"	SX6-4N
7" x .090" x 7/8" Universal	SX7-4N
8" x .090" x 7/8" Universal	SX8-4N
9" x .090" x 7/8" Universal	SX9-4N
10" x .100" x 7/8" Universal	SX10-4N



POWER COMBO® SS GENERAL PURPOSE
Laser Welded, Dry/Wet

4" x .080" x 7/8" - 5/8"	SS4-1
4 1/2" x .080" x 7/8" - 5/8"	SS4.5-1
5" x .080" x 7/8" - 5/8"	SS5-1
6" x .090" x 7/8" Universal	SS6-1
7" x .090" x 7/8" Universal	SS7-1
8" x .090" x 7/8" Universal	SS8-1
9" x .090" x 7/8" Universal	SS9-1
10" x .100" x 7/8" Universal	SS10-1

TURBO BLADES

Our turbo blades provide the smoothest, fastest cut on hard materials such as brick, block, concrete, tile and stone. Turbo is the common choice for faster, cleaner cutting.



SUPER TURBO GREEN CONCRETE
Dry/Wet

7" x .090" x DM - 5/8"	STGC7-H
8" x .090" x DM - 5/8"	STGC8-H



SUPER TURBO GRANITE
Dry/Wet

4" x .080" x 7/8" - 5/8"	STG4-H
4 1/2" x .080" x 7/8" - 5/8"	STG4.5-H
5" x .080" x 7/8" - 5/8"	STG5-H
6" x .080" x 7/8" - 5/8"	STG6-H
7" x .090" x DM - 5/8"	STG7-H
8" x .090" x DM - 5/8"	STG8-H
10" x .100" x DM - 5/8"	STG10-H



WDS SPIRAL TURBO - GREEN PRO SERIES
Dry/Wet, 9mm Rim Height - All Granites

4" x 7/8" - x 20mm - 5/8" / 4 holes	TSG4-H
4.5" x 7/8" x 20mm - 5/8" / 4 holes	TSG4.5-H
5" x 7/8" x 20mm - 5/8" / 4 holes	TSG5-H
6" x 7/8" - 5/8" / 4 holes	TSG6-H
7" x DM - 7/8" - 5/8" / 4 holes	TSG7-H



PREMIUM TURBO GRANITE
Dry/Wet 10mm Rim Height

4" x .080" x 7/8" - 5/8"	TGX4-4N
4 1/2" x .080" x 7/8" - 5/8"	TGX4.5-4N
5" x .080" x 7/8" - 5/8"	TGX5-4N
6" x .080" x 7/8" - 5/8"	TGX6-4N
7" x .090" Universal	TGX7-4N



SUPER TURBO—GENERAL PURPOSE
Dry/Wet

4" x .080" x 7/8" - 5/8"	STGP4-H
4 1/2" x .080" x 7/8" - 5/8"	STGP4.5-H
5" x .080" x 7/8" - 5/8"	STGP5-H
7" x .090" x DM - 5/8"	STGP7-H
8" x .090" x DM - 5/8"	STGP8-H
10" x .100" x DM - 5/8"	STGP10-H
12" x .100" x DM - 5/8"	STGP12-H
14" x .100" x DM - 5/8"	STGP14-H

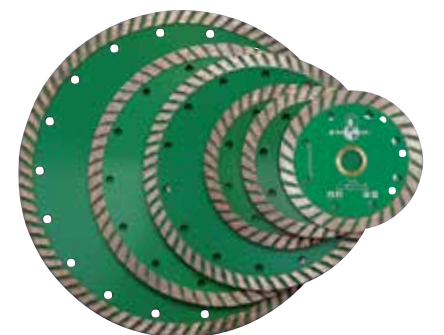

PREMIUM—GENERAL PURPOSE
Dry/Wet, 10mm Rim Height

4" x .080" x 7/8" - 5/8"	TX4-4N
4 1/2" x .080" x 7/8" - 5/8"	TX4.5-4N
5" x .080" x 7/8" - 5/8"	TX5-4N
6" x .080" x 7/8" - 5/8"	TX6-4N
7" x .090" Universal	TX7-4N
8" x .090" Universal	TX8-4N
9" x .090" Universal	TX9-4N
10" x .100" Universal	TX10-4N

SMALL DIAMETER BLADES

SMALL DIAMETER BLADES

SEGMENTED TURBO

High psi brick, paver brick and other dense materials are what these blades are designed for. This blade will cut labor costs by giving the best of both worlds: the life of a segmented and the speed of a turbo.



DRY/WET CUTTING

4" x .080" x 7/8" - 5/8"	SP4-D
4 1/2" x .080" x 7/8" - 5/8"	SP4.5-D
7" x .060" x 7/8" Diamond	SP7-D



DRY/WET CUTTING

4" x .080" x 7/8" - 5/8"	TP4-D
4 1/2" x .080" x 7/8" - 5/8"	TP4.5-D
7" x .060" x 7/8" Diamond	TP7-D

CONTINUOUS RIM

Our smooth continuous rim gives the fastest chip-free cut possible with both wet and dry applications for ceramics, porcelains, marbles and granites.



DRY/WET CUTTING

4" x .060" x 7/8" - 5/8"	DCR4-D
4 1/2" x .060" x 7/8" - 5/8"	DCR4.5-D
7" x .060" x 7/8"	DCR7-D

CONTINUOUS RIM

Our smooth continuous rim gives the fastest chip-free cut possible with both wet and dry applications for ceramics, porcelains, marbles and granites.

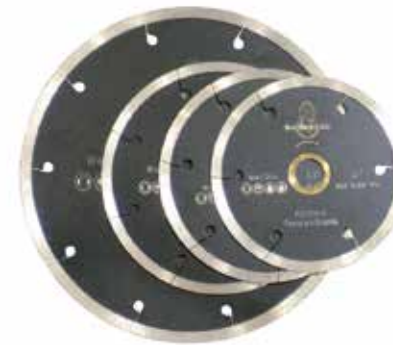

DRY PROFESSIONAL

Porcelain/Granite/Tile - Pro Series

4" x .060" x 7/8" - 20mm - 5/8"	PDCR4-H
4 1/2" x .060" x 7/8" - 20mm - 5/8"	PDCR4.5-H
5" x .060" x 7/8" - 20mm - 5/8"	PDCR5-H
7" x .060" x DM - 5/8"	PDCR7-H

SEGMENTED TURBO

High psi brick, paver brick and other dense materials are what these blades are designed for. This blade will cut labor costs by giving the best of both worlds: the life of a segmented and the speed of a turbo.

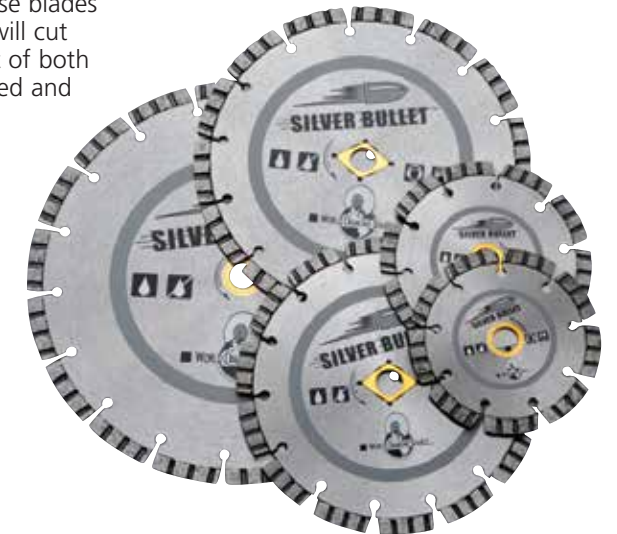

SILVER BULLET™
Brick and Hard Material,
Pro Laser Welded, Dry/Wet,
.350" Segment Height

4" x .080" x 7/8" - 5/8"	ST4-1	7" x .080" x DM - 5/8"	ST7-1
4.5" x .080" x 7/8" - 5/8"	ST4.5-1	8" x .080" x DM - 5/8"	ST8-1
5" x .080" x 7/8" - 5/8"	ST5-1	10" x .100" x DM - 5/8"	ST10-1

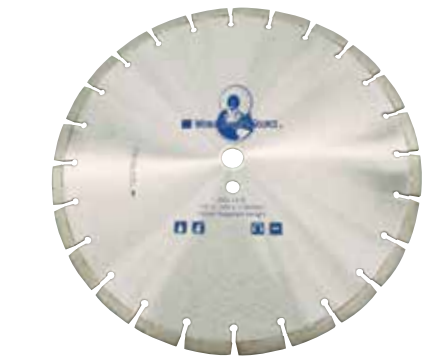

DRY/WET CUTTING

SINTER WELDED	
14" x .125" x 1" - 20mm	SE14-4N

LASER WELDED	
14" x .125" x 1" / 20mm	DCL14-D
14" x .125" - 20mm	DCL14-D/20



DRY/WET CUTTING

4" Continuous	
4" Turbo	
4" Segmented	3PK4-D



WET CUTTING

10" x .060" x 5/8"	WCR10-D
--------------------	----------------



WDS DRY CUT CONTINUOUS RIM
Tile / Marble - Wet or Dry Use

4 / 100 x .060 x 7/8" x 5/8"	DCRP4-7B
4 1/2" / 115 x .060 x 7/8" x 5/8"	DCRP4.5-7B
5 / 125 x .060 x 7/8" x 5/8"	DCRP5-7B
7 / 180 x .060 DM - 5/8"	DCRP7-7B

TUCK POINT BLADES

For the fast removal of soft, medium, or hard mortar these tuckpoint blades are the best quality on the market today. They're available in different segment heights, designs and bond hardness depending on the job specifications.



PREMIUM HARD BOND
For Soft-Medium Mortar,
10mm Segment Height, Dry/Wet

4" x .250" x 7/8" - 5/8"	TPX4-4N
4 1/2" x .250" x 7/8" - 5/8"	TPX4.5-4N
5" x .250" x 7/8" - 5/8"	TPX5-4N
7" x .250" x 7/8" - 5/8"	TPX7-4N



SUPER TUCK

4" x .250" x 7/8" - 5/8"	TPX4-HJ
4 1/2" x .250" x 7/8" - 5/8"	TPX4.5-HJ
5" x .250" x 7/8" - 5/8"	TPX5-HJ



ALL OF OUR STANDARD "DIY" LINE IS SILK SCREENED WITH CLAMS SHELL PACKING, READY FOR DISTRIBUTION.

SMALL DIAMETER BLADES

SMALL DIAMETER BLADES

TUCK POINT BLADES



ULTRA PRO
Laser Welded, Dry/Wet,
Bonded For Soft-Medium Mortar,
New Jumbo 10mm Segment Height

4" x .250" x 7/8" - 5/8"	TPXL4-7B
4 1/2" x .250" x 7/8" - 5/8"	TPXL4.5-7B
5" x .250" x 7/8" - 5/8"	TPXL5-7B
7" x .250" x 7/8" - 5/8"	TPXL7-7B

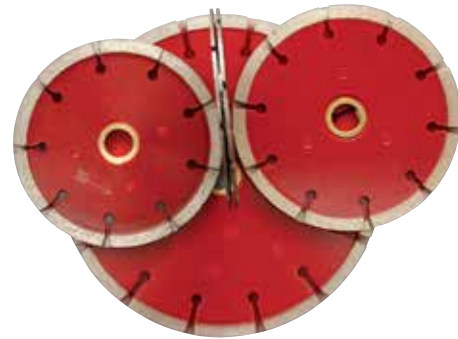

DUPLEX - SOFT BOND
For Hard Mortar, Dry/Wet

4" x .250" x 7/8" - 5/8"	DTP4-1
4 1/2" x .250" x 7/8" - 5/8"	DTP4.5-1
5" x .250" x 7/8" - 5/8"	DTP5-1
7" x .250" x 7/8" - 5/8"	DTP7-1



SPEED TUCK
Fast Cutting, 12mm Segment Height,
Dry/Wet

4" x .250" x 7/8" - 5/8"	STPX4-4N
4 1/2" x .250" x 7/8" - 5/8"	STPX4.5-4N
5" x .250" x 7/8" - 5/8"	STPX5-4N



ULTRA PRO SPECIAL SOFT BOND
Laser Welded, Dry/Wet,
For Hard Mortar
New Jumbo 10mm Segment Height

4" x .250" x 7/8" - 5/8"	TPXLS4-7B
4 1/2" x .250" x 7/8" - 5/8"	TPXLS4.5-7B
5" x .250" x 7/8" - 5/8"	TPXLS5-7B
7" x .250" x 7/8" - 5/8"	TPLXS7-7B



TRIPLEX - SOFT BOND
For Hard Mortar, Dry/Wet

4" x .375" x 7/8" - 5/8"	TTP4-1
4 1/2" x .375" x 7/8" - 5/8"	TTP4.5-1
5" x .375" x 7/8" - 5/8"	TTP5-1



SPEED TUCK - 10MM

4" x .250" x 7/8" - 5/8"	STPX4-4-1
4 1/2" x .250" x 7/8" - 5/8"	STPX4.5-4-1
5" x .250" x 7/8" - 5/8"	STPX5-4-1
6" x 6.4mm x 12mm x 7/8" - 5/8"	STPX6-1
7" x 6.4mm x 12mm x 7/8" - 5/8"	STPX7-1

CRACK CHASERS

Our crack chasers are designed for maximum life and high performance. They are great for sidewalk and concrete repairs because of their maneuverability in the cut.

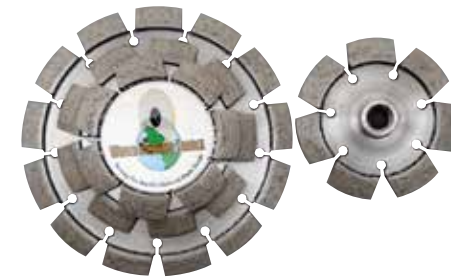

PRO CRACK CHASERS
Segmented, Laser Welded, Dry/Wet

4" x .375" x 7/8" - 5/8"	CCS4-5Q
4" x .375" x 5/8" 11 Threads	CCST4-5Q
5" x .375" x 7/8" - 5/8"	CCS5-5Q
5" x .375" x 5/8" 11 Threads	CCST5-5Q
7" x .375" x 7/8" - 5/8"	CCS7-5Q
7" x .375" x 5/8" - 11 Threads	CCST7-5Q

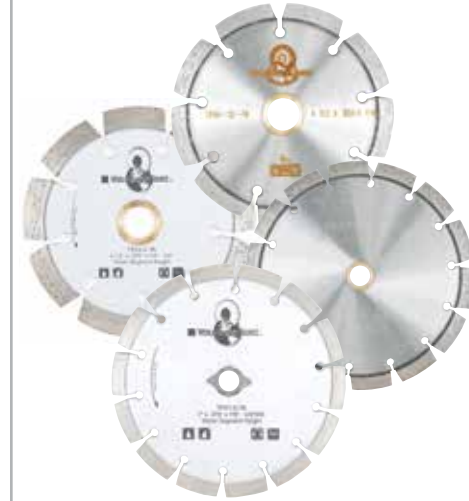

SQUARE SHAPED CRACK CHASERS
Dry/Wet

4" x .375" x 7/8" - 5/8"	TPX4-2-7B
4" x .500" x 7/8" - 5/8"	TPX4-12-7B
7" x .375" x 7/8" - 5/8"	TPX7-2-7B
7" x .500" x 7/8" - 5/8"	TPX7-12-7B



TURBO STYLE PRO CRACK CHASERS
Dry/Wet

4" x .375" x 5/8" 11 Threads	CCTT4-5Q
------------------------------	-----------------



MEDIUM BOND WITH KICKER SEGMENTS
Square Shaped / Concrete

8" x .500" x 1" w/Pinhole	TPP8-12-7B
---------------------------	-------------------



MEDIUM BOND WITH KICKER SEGMENTS
V-Shaped

8" x .500" x 1" w/Pinhole	CCS8-12-5Q
8" x .375" x 1" w/Pinhole	CCS8-38-7B



HARD BOND WITH KICKER SEGMENTS
Square Shaped - Asphalt

8" x .500" x 1" w/Pinhole	TPPA8-12-7B
---------------------------	--------------------

DIAMOND BLADES FOR TILE & TUB SAWS

SECTION C



THE ZIPPER®
The only blade that can
deliver a factory edge
(on hard porcelain)
with every cut!!!



AVAILABLE IN:
4" | 4.5" | 5" | 7" | 8" | 10"

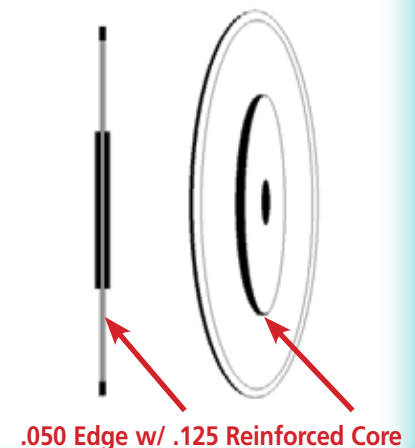

.050 Edge w/ .125 Reinforced Core

DIAMOND BLADES FOR TILE & TUB SAWS

DIAMOND BLADES FOR TILE & TUB SAWS

THE ZIPPER® The only blade that can deliver a factory edge (on hard porcelain) with every cut!!!



.050 Edge w/ .125 Reinforced Core

AVAILABLE IN:
4" / 4.5" / 5" / 7" / 8" / 10"

CERAMIC TILE/MARBLE/PORCELAIN



WET CUTTING—PREMIUM
.300" Segment Height

7" x .060" x 5/8"	WCRP7-1
8" x .060" x 5/8"	WCRP8-1
10" x .060" x 5/8"	WCRP10-1
12" x .080" x 5/8"	WCRP12-1
14" x .080" x 5/8"	WCRP14-1
20" x .125" x 5/8"	WCRP20-1



WET CUTTING—SUPREME
.375" Segment Height

8" x .060" x 5/8"	WCRX8-1
10" x .060" x 5/8"	WCRX10-1

PORCELAIN/GRANITE



WET CUTTING—PORCELAIN
.300" Segment Height, Fast Cutting

7" x .045" x 5/8"	WP7-7B
8" x .045" x 5/8"	WP8-7B
8" x .045" x 1"	WP8-7B/1
8" x .045" x 1 1/4"	WP8-7B/114
10" x .045" x 5/8"	WP10-7B
10" x .045" x 1"	WP10-7B/1

GLASS TILE/MOSAICS

A great choice for smooth cuts on glass tile and mosaics.

PRO SERIES
.300" Segment Height - Dry/Wet Continuous Rim

4" x .042"	WCL4-7B
6" x .042"	WCL6-7B
10" x .042"	WCL10-7B
8" x .050" x 5/8"	WCRG8-1
10" x .050" x 5/8"	WCRG10-1



WDS DRY CUT CONTINUOUS RIM
Tile / Marble – Wet or Dry Use

DCRP4-7B	4 / 100 x .060 x 7/8" x 5/8"
DCRP4.5-7B	4 1/2 / 115 x .060 x 7/8" x 5/8"
DCRP5-7B	5 / 125 x .060 x 7/8" x 5/8"
DCRP7-7B	7 / 180 x .060 DM - 5/8"

PORCELAIN/GRANITE



B-SLOT—PORCELAIN OR GRANITE
PRO SERIES
Dry/Wet, Fast Cutting

4" x .060" x 7/8" 20mm - 5/8"	PDCR4-H
4 1/2" x .060" x 7/8" 20mm - 5/8"	PDCR4.5-H
5" x .060" x 7/8" 20mm - 5/8"	PDCR5-H
7" x .060" x DM - 5/8"	PDCR7-H



ZIPPER® PORCELAIN – PRO SERIES
Dry/Wet, Heavy Flange for No Blade Flex, Turbo Rim for Aggressive Cuts, Extra Thin Rim for Perfectly Clean Cuts

4" x 7/8" - 20mm - 5/8"	PT4-H
4 1/2" x 7/8" - 20mm - 5/8"	PT4.5-H
5" x 7/8" - 20mm - 5/8"	PT5-H
7" x DM - 5/8"	PT7-H
8" x DM - 5/8"	PT8-H
10" x 1" - 5/8"	PT10-H
12" 60mm-50mm - 1"	PT12-H
14" 60mm-50mm - 1"	PT14-H

PROFILE WHEELS

Nothing beats our profile wheels for edging tile, marble, granite and porcelain. They are cost effective, fast and efficient because of their superior quality.



BLUE ZIPPER® PORCELAIN - HD SERIES
Dry/Wet, Heavy Flange for No Blade Flex, Turbo Rim for Aggressive Cuts, Extra Thin Rim for Perfectly Clean Cuts.

4" x 7/8" - 20mm - 5/8"	PZ4-B
4 1/2" x 7/8" - 20mm - 5/8"	PZ4.5-B
5" x 7/8" - 20mm - 5/8"	PZ5-B
7" x DM - 5/8"	PZ7-B
8" x DM - 5/8"	PZ8-B
10" x 1" - 5/8"	PZ10-B
12" 60mm-50mm - 1"	PZ12-B



RED ZIPPER® PORCELAIN – PRO SERIES
Dry/Wet, Heavy Flange for No Blade Flex, Turbo Rim for Aggressive Cuts, Extra Thin Rim for Perfectly Clean Cuts. Mesh Style segment for extra clean cut.

4" x 7/8" - 20mm - 5/8"	RPT4-H
4 1/2" x 7/8" - 20mm - 5/8"	RPT4.5-H
5" x 7/8" - 20mm - 5/8"	RPT5-H
7" x DM - 5/8"	RPT7-H
10" x 1" - 5/8"	RPT10-H



VACUUM BRAZED DIAMOND

6" x 3/8" Radius x 5/8"	PF6-5Q
6" x 1/2" Radius x 5/8"	PF6-5Q1
6" x 3/8" Profile Wheel Granite 3/8" Radius Vacuum Brazed	PFG6-5Q
6" x 1/2" Profile Wheel Granite 1/2" Radius Vacuum Brazed	PFG6-5Q1

BRICK/PAVERS

Our brick paver blades come both segmented and segmented turbo for your specific application and need.



SILVER BULLET®
Brick & Hard Material Pro Laser Welded, Dry/Wet, .375" Segment Height, Segmented Turbo

10" x .100" x DM - 5/8"	ST10-1
-------------------------	---------------



POWER COMBO® GPS SEGMENTED
Special Soft Bond Formula

10" x .080" x 7/8" - 5/8"	SP10-5Q
---------------------------	----------------

SURFACE PREPARATION & FLOOR POLISHING

SECTION D



WDS
WORLD DIAMOND SOURCE



HALO WHEEL

A Polisher's Dream - This Ultra-Fast Cup Wheel is designed to grind the hardest concrete. It is your "Go-to" cup wheel for quick first cuts. With Superior 30 Grit Diamonds and our proven Bond Formula, its performance and life will exceed your expectations.



**HALO WHEEL
30/40 GRIT**

4" Halo Wheel (Threaded) - 16/20 Grit	SCUPT4-1/30
5" Halo Wheel (Non-Threaded) - 16/20 Grit	SCUP5-1/30
5" Halo Wheel (Threaded) - 16/20 Grit	SCUPT5-1/30
7" Halo Wheel (Non-Threaded) - 16/20 Grit	SCUP7-1/30
7" Halo Wheel (Threaded) - 16/20 Grit	SCUPT7-1/30



WHEEL OF DEATH

The "Wheel of Death" is one of the fastest and most aggressive cup wheels for the hardest of concrete. It's 16 Grit diamond grinds the hardest concrete out there. For guaranteed speed and production, this is the cup wheel to use.



**WHEEL OF DEATH
16/20 GRIT**

4" Wheel of Death (Non Threaded) - 16/20 Grit	SCUP4-1
5" Wheel of Death (Non Threaded) - 16/20 Grit	SCUP5-1
5" Wheel of Death (Threaded) - 16/20 Grit	SCUPT5-1
7" Wheel of Death (Non Threaded) - 16/20 Grit	SCUP7-1
7" Wheel of Death (Threaded) - 16/20 Grit	SCUPT7-1





PCD ZILLA

- Massive 13mm PCD segment designed to rip and tear through thick materials
- Giant crushed PCD filled rhombus stabilizer segment pulverizes materials below it
- Directional arrows on face of plate
- Highest quality PCD on the market

GODZILLA XL 13MM PCD SEGMENT

Godzilla XL PCD - Left	PCDTRAPXL
Godzilla XL PCD - Right	PCDTRAPXR



MINI-ZILLA PCD

- 2 X 6.5mm PCD's to rip and tear through thinner materials
- Giant crushed PCD filled rhombus stabilizer segment pulverizes materials below it
- Super fast and aggressive
- Highest quality PCD on market

MINI-ZILLA PCD - 2X WITH RHOMBUS CRUSHED PCD

Mini-Zilla PCD - Left	PCGL
Mini-Zilla PCD - Right	PCGR



DEATH TRAP

- 16 and 30 Grit
- Triple Segment design for increased production
- Known as the "Cap Killer"
- Designed for opening up and removing the concrete cap on the hardest concretes
- Works great for first cut
- 7, 8, 9, on MOHs
- Proprietary bond for ultra hard concrete

GOLD - ULTRA SOFT BOND SEGMENTS

16/20 Grit - Ultra Soft	SCC-16/20
30/40 Grit - Ultra Soft	SCC-30/40



SPEED TRAP

SPEED TRAP

- Great for leaving tight scratch patterns on initial cuts
- Removes cure & seal
- Less glazing on hard concrete
- First cut diamonds for polishable overlays
- Works great on light machines
- Ultra fast grinding on ultra hard floors giving super tight scratch patterns
- Fast production / less gumming
- Available in multiple bonds



SPEED TRAP (GRAY)

30 Grit - Ultra Soft
60 Grit - Ultra Soft

DOTTRAP
DOTTRAP60



SUPERNOVA



The SUPERNOVA Signature Series sets the new gold standard for ultra shine. The thick 12mm pad gives you tremendous life, while our proprietary formula promotes award winning shines and production rates that are second to none.

SUPERNOVA

- Newest bridge between metals and resins
- Proprietary bond for fast cuts and tighter scratches
- Combination of ceramic, copper, and resin up to 200 Grit
- Resin only 400 Grit and up
- Our 400 Grit achieves higher DOI in lower Grits, achieves higher level of shine faster
- Foam cushion between velcro & tool
- 30, 50, 100, 200 – Wet / Dry
- 400, 800, 1500, 3000 – Comes wet only or dry only



3" Hybrid Floor Pad - Wet/Dry - 30 Grit	FPX3-30
3" Hybrid Floor Pad - Wet/Dry - 50 Grit	FPX3-50
3" Hybrid Floor Pads - Wet/Dry - 100 Grit	FPX3-100
3" Hybrid Floor Pads - Wet/Dry - 200 Grit	FPX3-200
3" Hybrid Floor Pads - Dry Only - 400 Grit	FPX3-400
3" Hybrid Floor Pads - Dry Only - 800 Grit	FPX3-800
3" Hybrid Floor Pads - Dry Only - 1500 Grit	FPX3-1500
3" Hybrid Floor Pads - Dry Only - 3000 Grit	FPX3-3000
3" Resin Floor Pad - Wet Only - 400 Grit	SUPERFPX3-400
3" Resin Floor Pad - Wet Only - 800 Grit	SUPERFPX3-800
3" Resin Floor Pad - Wet Only - 1500 Grit	SUPERFPX3-1500
3" Resin Floor Pad - Wet Only - 3000 Grit	SUPERFPX3-3000

SURFACE PREPARATION UNIVERSAL MAGNETIC PLATES

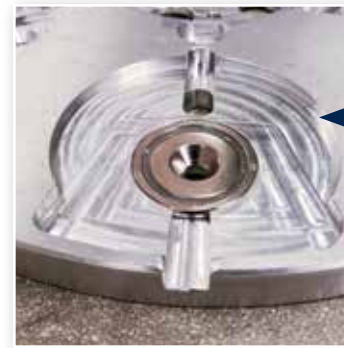
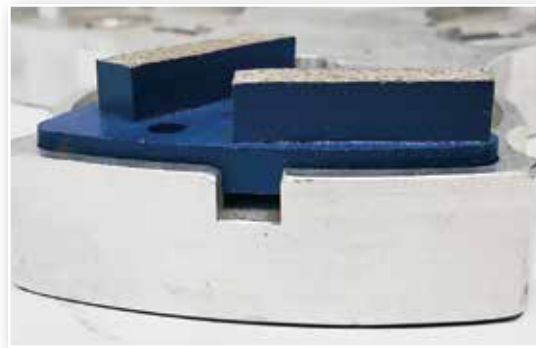

COMBO CAVITY FOR 3" ROUND AND TRAP TOOLING
MADE IN USA
 AIRCRAFT GRADE ALUMINUM
 SUPER DUTY HEAT RESISTANT MAGNETS

SURFACE PREPARATION UNIVERSAL MAGNETIC PLATES

UNIVERSAL MAGNETIC QUICK CHANGE PLATES

Universal Magnetic Quick Change Plate measurements are approximate. Please use for reference purposes only.



UNIVERSAL MAGNETIC PLATE FOR AZTEC®
 4" Universal Magnetic Plate **AUPAZ-4**



UNIVERSAL MAGNETIC PLATE FOR EDCO®
 9.75" Universal Magnetic Plate **AUPED-10NEW**



UNIVERSAL MAGNETIC PLATE FOR HTC® 420'S
 6" Universal Magnetic Plate **AUPH-6**



UNIVERSAL MAGNETIC PLATE FOR AZTEC®
 12.75" Universal Magnetic Plate **AUPA-12**



UNIVERSAL MAGNETIC PLATE FOR EDCO® SINGLE HEAD
 11.5" Universal Magnetic Plate **AUPB12/6T**



UNIVERSAL MAGNETIC PLATE FOR HTC® 500'S & 600'S
 9" Universal Magnetic Plate **AUPH-9**



UNIVERSAL MAGNETIC PLATE FOR EDCO®
 9.75" Universal Magnetic Plate **AUPED-10**



UNIVERSAL MAGNETIC PLATE FOR DIAMATIC® 780
 9" Universal Magnetic Plate **AUPD-9**



UNIVERSAL MAGNETIC PLATE FOR HTC® 800'S & 900'S
 10" Universal Magnetic Plate **AUPH-10**

UNIVERSAL MAGNETIC QUICK CHANGE PLATES

Universal Magnetic Quick Change Plate measurements are approximate. Please use for reference purposes only.



UNIVERSAL MAGNETIC PLATE FOR HUSQVARNA® 530'S & 680'S
 8.5" Universal Magnetic Plate **AUPHUS-9**



UNIVERSAL MAGNETIC PLATE FOR HUSQVARNA® 400
 16" PLATE **AUPHUS-16**

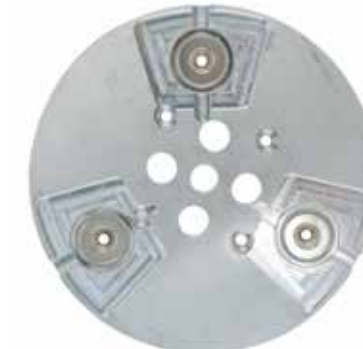

UNIVERSAL MAGNETIC PLATE FOR LAVINA® 21-1.5, 21-3
 8" Universal Magnetic Plate **AUPL-8**



UNIVERSAL MAGNETIC PLATE FOR HUSQVARNA® 820'S
 10" Universal Magnetic Plate **AUPHUS-10**



UNIVERSAL MAGNETIC PLATE FOR INNOVATECH™ PREDATOR P850 & 2400'S
 9" Universal Magnetic Plate **AUPP-9**



UNIVERSAL MAGNETIC PLATE FOR LAVINA®
 8" Universal Magnetic Plate **AUPL-8.875**



UNIVERSAL MAGNETIC PLATE FOR HUSQVARNA® 280
 11.5" Universal Magnetic Plate **AUPHUS-11.5**



UNIVERSAL MAGNETIC PLATE FOR INNOVATECH™ PREDATOR P3200
 10" Universal Magnetic Plate **AUPP-10**

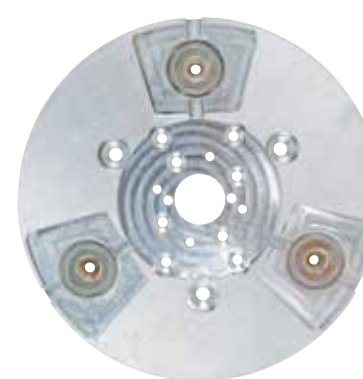

UNIVERSAL MAGNETIC PLATE FOR LAVINA® 20NS
 9" Universal Magnetic Plate **AUPL-20NS-9**

SURFACE PREPARATION UNIVERSAL MAGNETIC PLATES



SURFACE PREPARATION UNIVERSAL MAGNETIC PLATES

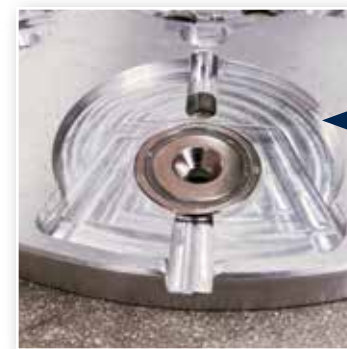

COMBO CAVITY FOR
3" ROUND AND TRAP TOOLING
MADE IN USA
AIRCRAFT GRADE ALUMINUM
SUPER DUTY HEAT
RESISTANT MAGNETS

UNIVERSAL MAGNETIC QUICK CHANGE PLATES

Universal Magnetic Quick Change Plate measurements are approximate. Please use for reference purposes only.

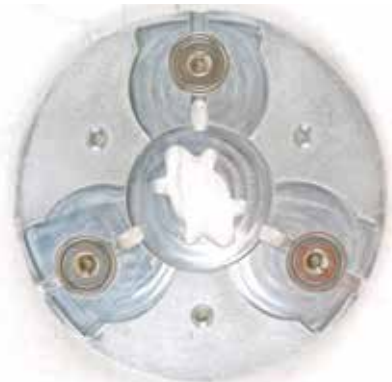

PLATE FOR LAVINA® 20, 25 & 32'S
9" Universal Magnetic Plate **AUPL-9**



UNIVERSAL MAGNETIC PLATE FOR LAVINA®
13.25" Universal Magnetic Plate **AUPL-GX30P**



UNIVERSAL MAGNETIC PLATE FOR LEVETEC®
9.5" Universal Magnetic Plate **AUPL-9**



UNIVERSAL MAGNETIC PLATE FOR LAVINA® 30L, 30G
12.5" Universal Magnetic Plate **AUPL-12.5**



UNIVERSAL MAGNETIC PLATE FOR LAVINA®
13.125" Universal Magnetic Plate **AUPL-32-13**



UNIVERSAL MAGNETIC PLATE FOR ONFLOOR®
6" Universal Magnetic Plate **AUPOF-6**



UNIVERSAL MAGNETIC PLATE FOR LAVINA®
9" Universal Magnetic Plate **AUPL-25S-9**



UNIVERSAL MAGNETIC PLATE FOR ONFLOOR® 20
7.5" Universal Magnetic Plate **AUPOF20-7.5**

UNIVERSAL MAGNETIC QUICK CHANGE PLATES

Universal Magnetic Quick Change Plate measurements are approximate. Please use for reference purposes only.



UNIVERSAL MAGNETIC PLATE FOR PREPMASTER® 2420 & 4430
8.5" Universal Magnetic Plate **AUPPM-4430**



UNIVERSAL MAGNETIC PLATE FOR PREPMASTER® JR
9.25" Universal Magnetic Plate **AUPPM-JR**



UNIVERSAL MAGNETIC PLATE FOR SASE®
10.5" Universal Magnetic Plate **AUPS-8000-10.5**



UNIVERSAL MAGNETIC PLATE FOR PREPMASTER® 3030
10.5" Universal Magnetic Plate **AUPPM-3030**



UNIVERSAL MAGNETIC PLATE FOR SASE®
6" Universal Magnetic Plate **AUPS-6**

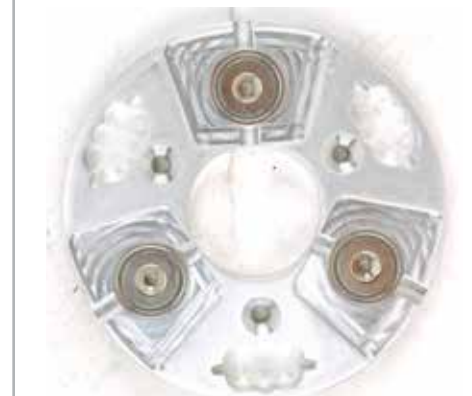

UNIVERSAL MAGNETIC PLATE FOR SASE® 535
7.75" Universal Magnetic Plate **AUPD-7**



UNIVERSAL MAGNETIC PLATE FOR PREPMASTER®
11" Universal Magnetic Plate **AUPPM-3030L**



UNIVERSAL MAGNETIC PLATE FOR SASE®
7.75" Universal Magnetic Plate **AUPS-5000-7.75**

SURFACE PREPARATION UNIVERSAL MAGNETIC PLATES

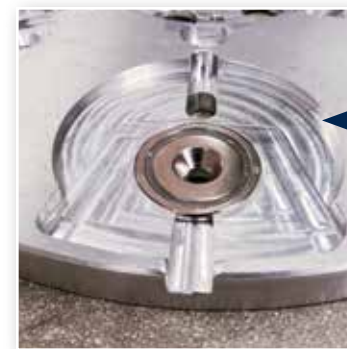

**COMBO CAVITY FOR
3" ROUND AND TRAP TOOLING
MADE IN USA
AIRCRAFT GRADE ALUMINUM
SUPER DUTY HEAT
RESISTANT MAGNETS**

SURFACE PREPARATION UNIVERSAL MAGNETIC PLATES

UNIVERSAL MAGNETIC QUICK CHANGE PLATES

Universal Magnetic Quick Change Plate measurements are approximate. Please use for reference purposes only.



UNIVERSAL MAGNETIC PLATE FOR SKANMASKIN®
6" Universal Magnetic Plate **AUPSK-450-6**



UNIVERSAL MAGNETIC PLATE FOR TERRCO® 3300
11.75" Universal Magnetic Plate **AUPT-3300**

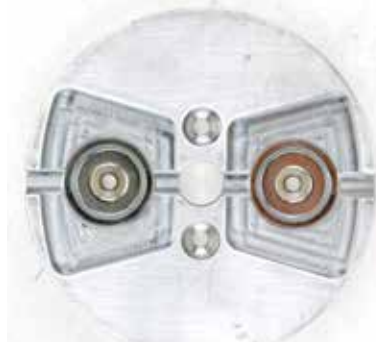

UNIVERSAL MAGNETIC PLATE FOR WERKMASTER®
5.75" Universal Magnetic Plate **AUPWT-534**

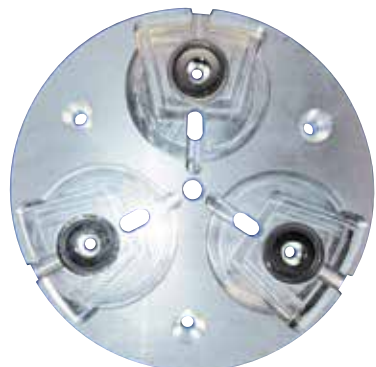

UNIVERSAL MAGNETIC PLATE FOR SKANMASKIN®
8.25" Universal Magnetic Plate **AUPSK-650-8**



SPACER PLATE FOR TERRCO® 3300
7.5" Universal Magnetic Plate **AUPT-3300-7.5**



UNIVERSAL MAGNETIC PLATE FOR WERKMASTER®
6.75" Universal Magnetic Plate **AUPWT-634**

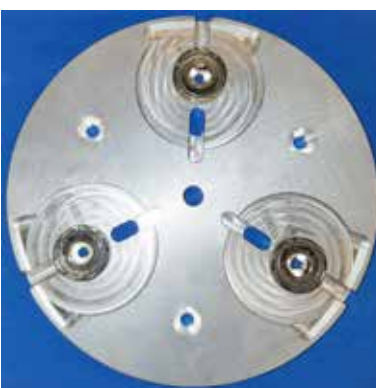

UNIVERSAL MAGNETIC PLATE FOR SKANMASKIN®
9" Universal Magnetic Plate **AUPSK-700-9**



UNIVERSAL MAGNETIC PLATE FOR TERRCO®
9.5" Universal Magnetic Plate **AUPT-7500**

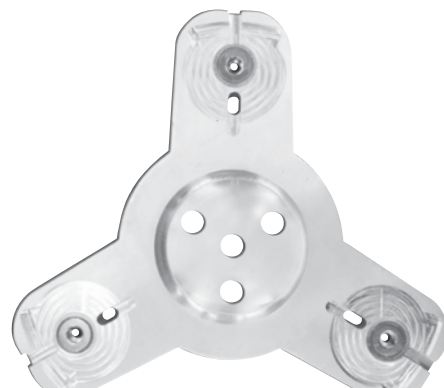

PLATE B&W® MACHINE
11.25" Universal Magnetic Plate **AUPBW-1**

UNIVERSAL MAGNETIC QUICK CHANGE PLATES

Universal Magnetic Quick Change Plate measurements are approximate. Please use for reference purposes only.



UNIVERSAL MAGNETIC PLATE FOR ASL®
9.5" Universal Magnetic Plate **AUP-ASLT9**



UNIVERSAL MAGNETIC PLATE GRINDING HEADS TRAPS ONLY
9.75" Universal Magnetic Plate **AUPGH-10**



UNIVERSAL MAGNETIC PLATE FOR GENIE
8.75" Universal Magnetic Plate **AUP-GENIE**



UNIVERSAL MAGNETIC PLATE FOR EAGLE®
12.5" Universal Magnetic Plate **AUPE-12.5**

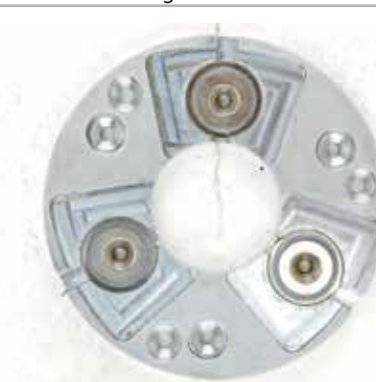

UNIVERSAL MAGNETIC PLATE AIRTECH BS600
3.75" Universal Magnetic Plate **AUPAT-4**



UNIVERSAL MAGNETIC PLATE FOR AIRTEC
7.75" Universal Magnetic Plate **AUPA550-8**

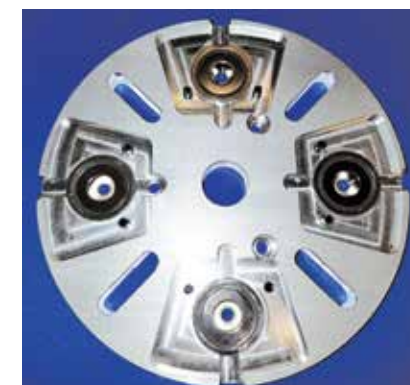

UNIVERSAL MAGNETIC PLATE FOR DITEQ®
8" Universal Magnetic Plate **AUPDIT-8**



UNIVERSAL MAGNETIC PLATE GRAN QUARTZ 70
9.5" Universal Magnetic Plate **AUPGQ-9**



UNIVERSAL MAGNETIC PLATE FOR KUT RITE
7.75" Universal Magnetic Plate **AUP-C2000-734**

SURFACE PREPARATION

UNIVERSAL MAGNETIC PLATES



VARIOUS UNIVERSAL MAGNETIC QUICK CHANGE PLATES

Universal Magnetic Quick Change Plate measurements are approximate. Please use for reference purposes only.



UNIVERSAL MAGNETIC PLATE FOR KLINDEX 530
8" Universal Magnetic Plate **AUPKL-8-3**



UNIVERSAL MAGNETIC PLATE FOR ASL PRO 9 PROPANE
9.75" Universal Magnetic Plate **AUPLT-750-10**



UNIVERSAL MAGNETIC PLATE FOR PIONEER ECLIPSE 450 GP
17.5" Universal Magnetic Plate **AUPPE-450-17**

ACCESSORIES



TRAP VELCRO PLATE
Velcro backed for use of resin on trap systems.
Velcro Trap Plate **VTRAP**

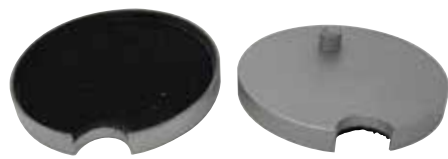

FLOOR MACHINE VELCRO HOLDERS FOR RESINS WITH BACK PIN AND LIP
Velcro backed plate for use in 3" round cavity of universal plate system that has a lip to prevent resin pads from shifting during use.
3" Velcro for Resins w/ Back & Lip **VPLATELIP**



PLASTIC UNIVERSAL VELCRO PLATE
Quick change system for all assorted resin products with velcro backing.

7-3/4" Plastic Resin Plate for HTC & SASE	PURV-7.34/5000
9" Plastic Resin Plate Ffor HTC 500'S & 600'S	PURV-9
10" Plastic Resin Plate Ffor HTC 800'S & 900'S	PURV-10
10 1/2" Plastic Resin Plate Ffor HTC 800'S & 900'S	PURVI-10.5

CONCRETE SURFACE PROFILES (CSP)

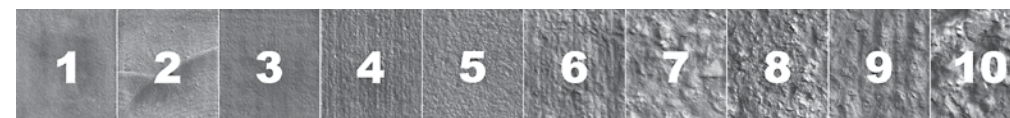

SURFACE PREPARATION

BUSH HAMMERS

BUSH HAMMERS

World Diamond Source's new bush hammer tools create a bush-hammered profile on concrete, ideal for use on exterior spaces and creating anti-slip surfaces. The WDS Bush Hammer rollers are designed to pulverize the surface of concrete making it fast and easy to get full aggregate exposure. It is also a great option for removing thin coatings when prepping the floor for epoxy application. However, these tools are NOT intended to remove any flexible coatings or most epoxies.

Each bush hammer assembly comes with 2 components - the hammer plate, and a set of 3 rollers with fastening screws (12 Screws and 12 lockwashers - 4 per roller). This 2 component system is packaged and sold separately so that you can purchase the Bush Hammer Roller Assembly separate for multiple uses with the same Hammer Plate.

The WDS Bush Hammer Rollers can be used on Sase®, Husqvarna®, and Diamatic® machines with the use of the WDS Hammer plate system. Bush hammers are not recommended for use with high rpm machines and should be run at no more than 700 rpms.

- Aggressive profiling tool that breaks down the surface that standard diamonds can't touch.
- Removes old glue and resin coatings, particularly thick resins.
- Provides a good bonding surface or anti-slip finish on concrete, granite, and marble
- Long lasting tool – up to 15,000 SF when used properly (Avoid steel and other obstructions in floor to maximize life).
- Two Separate Components to maximize value and get the most life from the reusable Hammer Plate.
- Bush Hammers come fully greased, and grease should be added before each use being careful not to over grease and blow out the seals.



BUSH HAMMER ASSEMBLY WITH MOUNTING HARDWARE

Bush Hammer Assembly w / Bolts - (1 Piece)

BHSET



BUSH HAMMER PLATES

10.5" Steel Plate for Brush Hammers – fits SASE® 8000	SPS-10.5
9" Steel Plate for Brush Hammers – fits Prep Master® Junior	SPPM-JR
9" Steel Plate for Brush Hammers – fits Diamatic® 780	SPD-9
10 1/2" Steel Plate for Brush Hammers – fits Husqvarna® 820	SPHUS-10.5



SURFACE PREPARATION

PCD TRAPEZOIDS

SURFACE PREPARATION

PCD TRAPEZOIDS

PCD TRAPEZOIDS

This new technology, "PCD," is polycrystalline diamond. It is made with very high pressure and temperature. This is a controlled alternative to natural diamond, which has inconsistent qualities. PCD is being used especially for epoxy coating removals.



Mini-Zilla PCD

- 2 x 6.5mm PCD's to rip and tear through thinner materials
- Giant crushed PCD filled rhombus stabilizer segment pulverizes materials below it
- Super fast and aggressive
- Highest quality PCD on market
- DRY USE – for thinner epoxy coatings and glue removal.

Mini-Zilla PCD - 2 X PCD's - w / Rhombus Crushed PCD - Left **PCGL**
Mini-Zilla PCD - 2 X PCD's - w / Rhombus Crushed PCD - Right **PCGR**

Godzilla PCD

- Massive 13mm PCD Segment designed to rip and tear through thick materials
- Giant crushed PCD filled rhombus stabilizer segment pulverizes materials below it
- Directional arrows on face of plate
- Highest quality pcd on market

DRY USE – For extra heavy duty removal of thick coatings.

GODZILLA XL PCD - Left **PCDTRAPXL**
GODZILLA XL PCD - Right **PCDTRAPXR**



PCD TRAPEZOIDS - PCD TOOLING W/ STABILIZER SEGMENTS AND PIN ON BACK PLATE



DOUBLE RHOMBUS XL CRUSHED PCD SEGMENTS - DRY USE – for general removal of epoxy coatings and paint.

Double Rhombus XL Crushed PCD Segments **RSPCD**



DOUBLE BAR CRUSHED PCD SEGMENTS DRY USE – for general removal of epoxy coatings and paint.

Double Bar Crushed PCD Segments **DSPCG**



SHARP EDGE PCD TRAP - DRY USE
For general removal of epoxy coatings, paint and glue.

6 X Sharp Edge PCD's - Left **PCDS-L**
6 X Sharp Edge PCD's - Right **PCDS-R**



2 X PCD'S - NO STABILIZER BAR DRY USE

For removal of thick epoxy coatings and urethane paints.

2 X PCD's - No Stabilizer Bar - Left **PCDL**
2 X PCD's - No Stabilizer Bar - Right **PCDR**



PRO SERIES PCD

3 XL Rhombus Crushed PCD Segments **3RSPCD**



Mini-Zilla PCD

- 2 x 6.5mm PCD's to rip and tear through thinner materials
- Crushed PCD filled stabilizer rhombus segment
- Super fast and aggressive
- Highest quality PCD on market

2X PCD W/ RHOMBUS CRUSHED PCD PRO SERIES PCD - THIN COATINGS

2X PCD - w/ Rhombus Segment - Left **3PCDPL**
2X PCD - w/ Rhombus Segment - Right **3PCDPR**

Godzilla XL PCD

- Massive 13mm PCD Segment designed to rip and tear through thick materials
- Giant Crushed PCD filled rhombus stabilizer segment pulverizes materials below it
- Directional arrows on face of plate
- Highest quality PCD on market

2X PCD W/ RHOMBUS CRUSHED PCD PRO SERIES PCD - THICK COATINGS

3" w/ Rhombus Segment - Pin On Back - Left **PCDXL3-L**
3" w/ Rhombus Segment - Pin On Back - Right **PCDXL3-R**



SURFACE PREPARATION METAL BOND TRAPEZOIDS

WDS | WORLD DIAMOND SOURCE® BOND RECOMMENDATIONS



WDS GRIT SYSTEMS

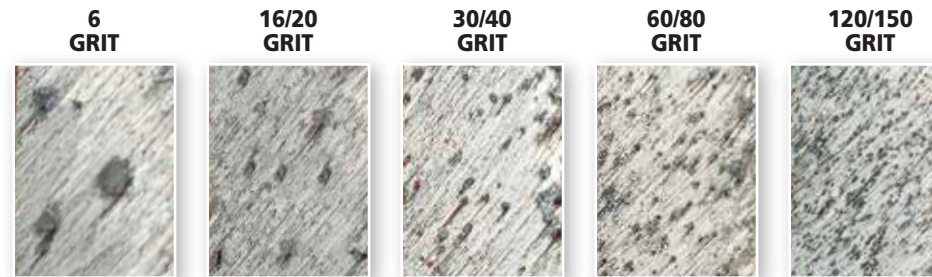

SURFACE PREPARATION METAL BOND TRAPEZOIDS

METAL BOND SINGLE ROUND TRAPEZOIDS - PRO SERIES

- Highest Quality Diamond Possible for Increased Life and Production
- Pre-Dressed Segments for Instant Grinding Right Out of the Box
- Item Numbers Engraved on Back of Shoe to Always Know Which Tool is Which
- Available in 9 Different Bond Strengths
- Trusted Bonds Proven Effective on Floors Everywhere
- No Break In Period

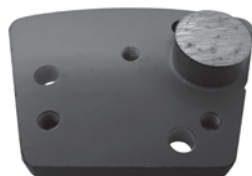

**SINGLE ROUND TRAPEZOIDS
MEDIUM BOND (BLACK)**

16/20 Grit - Single Round	1RSM-16/20
30/40 Grit - Single Round	1RSM-30/40
60/80 Grit - Single Round	1RSM-60/80
120/150 Grit - Single Round	1RSM-120/150

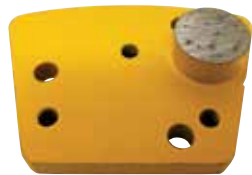

**SINGLE ROUND TRAPEZOIDS
2X-EXTREME SOFT BOND (YELLOW)**

16/20 Grit - Single Round	1RSX2-16/20
30/40 Grit - Single Round	1RSX2-30/40
60/80 Grit - Single Round	1RSX2-60/80
120/150 Grit - Single Round	1RSX2-120/150



**SINGLE ROUND TRAPEZOIDS
3X-EXTREME SOFT BOND (GRAY)**

16/20 Grit - Single Round	1RSX3-16/20
30/40 Grit - Single Round	1RSX3-30/40
60/80 Grit - Single Round	1RSX3-60/80
120/150 Grit - Single Round	1RSX3-120/150

HOW DIAMONDS ARE MADE

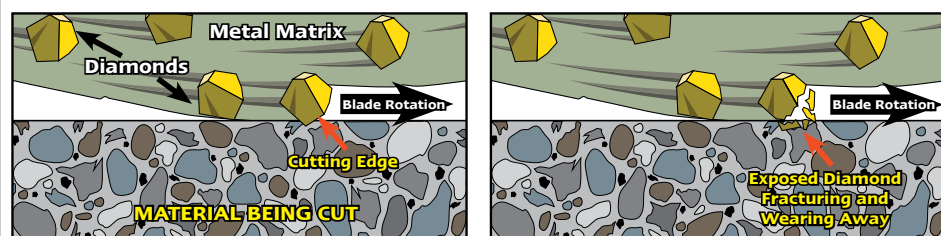

The exposed diamond crystals do the grinding work. The metal matrix or bond holds the diamond in place. Trailing behind each exposed diamond is a bond tail which helps to support the diamond. As the blade rotates through the material, the exposed surface diamonds grind the material.

After several thousand passes through the material, the exposed diamonds begin to crack and fracture. The matrix holding the diamonds also begins to wear away.

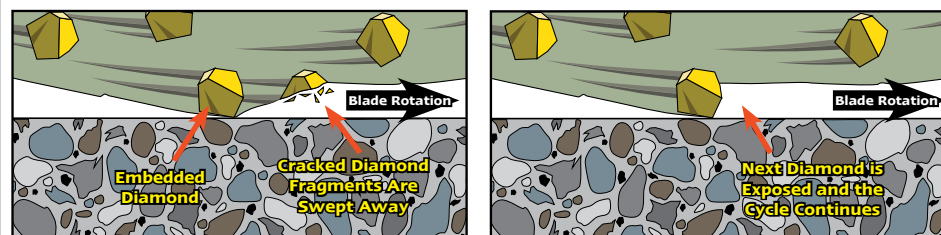

Eventually the diamond completely breaks apart and its fragments are swept away with the material it is grinding. When the blade is cooled with water this material, included with water, produces slurry.

As the old diamonds are fractured and worn away they are replaced by new diamonds and the process continues until the segments are worn down to the core.

#1 Rule for Diamond Blades:

Use a Hard Bond to Cut Something Soft and Use a Soft Bond to Cut Something Hard

DIAMOND QUALITY - YOU GET WHAT YOU PAY FOR



- LOW QUALITY SYNTHETIC DIAMONDS**
- Weaker crystals with irregular shape
 - Shorter life & lower cutting rates
 - Lower thermal stability
 - Does not handle steel & hard aggregates well
 - Jagged points that break causing faster wear & lower cutting & drilling performance
 - Widely used in low priced dry products



- MEDIUM QUALITY SYNTHETIC DIAMONDS**
- Good crystal strength & shape
 - Good for sawing & drilling applications
 - Good cutting speed
 - Handles moderate steel & hard aggregate applications

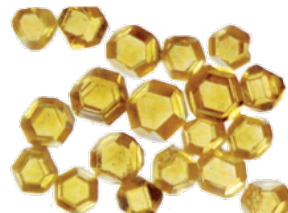

- HIGH QUALITY SYNTHETIC DIAMONDS**
- Strongest crystals
 - Lasts longer
 - Withstands high temperatures
 - Octahedral shape for increased tool life & faster cutting
 - High impact strength against steel & hard aggregate

METAL BOND DOUBLE ROUND TRAPEZOIDS - PRO SERIES

- Highest Quality Diamond Possible for Increased Life and Production
- Pre-Dressed Segments for Instant Grinding Right Out of the Box
- Item Numbers Engraved on Back of Shoe to Always Know Which Tool is Which
- Available in 9 Different Bond Strengths
- Trusted Bonds Proven Effective on Floors Everywhere
- No Break In Period



**DOUBLE ROUND TRAPEZOIDS
EXTRA HARD BOND (GREEN)**

30/40 Grit - Double Round	RSXH-30/40
60/80 Grit - Double Round	RSXH-60/80



**DOUBLE ROUND TRAPEZOIDS
HARD BOND (RED)**

16/20 Grit - Double Round	RSH-16/20
30/40 Grit - Double Round	RSH-30/40
60/80 Grit - Double Round	RSH-60/80
120/150 Grit - Double Round	RSH-120/150



**DOUBLE ROUND TRAPEZOIDS
MEDIUM BOND (BLACK)**

16/20 Grit - Double Round	RSM-16/20
30/40 Grit - Double Round	RSM-30/40
60/80 Grit - Double Round	RSM-60/80
120/150 Grit - Double Round	RSM-120/150



**DOUBLE ROUND TRAPEZOIDS
SOFT BOND (BLUE)**

16/20 Grit - Double Round	RSS-16/20
30/40 Grit - Double Round	RSS-30/40
60/80 Grit - Double Round	RSS-60/80
120/150 Grit - Double Round	RSS-120/150



**DOUBLE ROUND TRAPEZOIDS
X-EXTREME SOFT BOND (WHITE)**

16/20 Grit - Double Round	RSSX-16/20
30/40 Grit - Double Round	RSSX-30/40
60/80 Grit - Double Round	RSSX-60/80
120/150 Grit - Double Round	RSSX-120/150



**DOUBLE ROUND TRAPEZOIDS
1X-EXTREME SOFT BOND (ORANGE)**

16/20 Grit - Double Round	RSX1-16/20
30/40 Grit - Double Round	RSX1-30/40
60/80 Grit - Double Round	RSX1-60/80
120/150 Grit - Double Round	RSX1-120/150



**DOUBLE ROUND TRAPEZOIDS
2X-EXTREME SOFT BOND (YELLOW)**

16/20 Grit - Double Round	RSX2-16/20
30/40 Grit - Double Round	RSX2-30/40
60/80 Grit - Double Round	RSX2-60/80
120/150 Grit - Double Round	RSX2-120/150



**DOUBLE ROUND TRAPEZOIDS
3X EXTREME SOFT BOND (GRAY)**

16/20 Grit - Double Round	RSX3-16/20
30/40 Grit - Double Round	RSX3-30/40
60/80 Grit - Double Round	RSX3-60/80
120/150 Grit - Double Round	RSX3-120/150

SURFACE PREPARATION METAL BOND TRAPEZOIDS

WDS | WORLD DIAMOND SOURCE. BOND RECOMMENDATIONS



WDS GRIT SYSTEMS

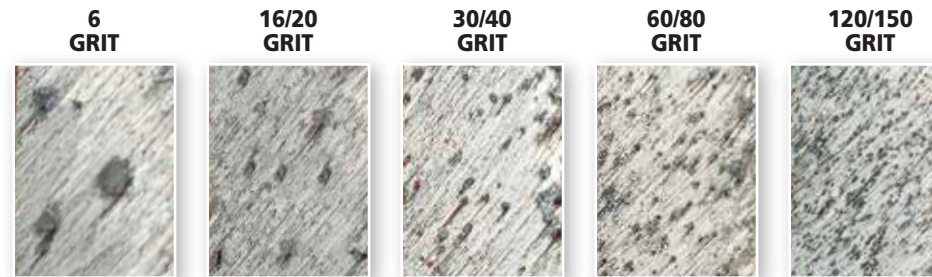

SURFACE PREPARATION METAL BOND TRAPEZOIDS

METAL BOND DOUBLE BAR TRAPEZOIDS - PRO SERIES

- Highest Quality Diamond Possible for Increased Life and Production
- Pre-Dressed Segments for Instant Grinding Right Out of the Box
- Item Numbers Engraved on Back of Shoe to Always Know Which Tool is Which
- Available in 9 Different Bond Strengths
- Trusted Bonds Proven Effective on Floors Everywhere
- No Break In Period



DOUBLE BAR TRAPEZOIDS HARD BOND (RED)

6 Grit - Double Bar	DSH-6
16/20 Grit - Double Bar	DSH-16/20
30/40 Grit - Double Bar	DSH-30/40
60/80 Grit - Double Bar	DSH-60/80
120/150 Grit - Double Bar	DSH-120/150



DOUBLE BAR TRAPEZOIDS X-EXTREME SOFT BOND (WHITE)

16/20 Grit - Double Bar	DSSX-16/20
30/40 Grit - Double Bar	DSSX-30/40
60/80 Grit - Double Bar	DSSX-60/80
120/150 Grit - Double Bar	DSSX-120/150



DOUBLE BAR TRAPEZOIDS 2X-EXTREME SOFT BOND (YELLOW)

6 Grit - Double Bar	DSX2-6
16/20 Grit - Double Bar	DSX2-16/20
30/40 Grit - Double Bar	DSX2-30/40
60/80 Grit - Double Bar	DSX2-60/80
120/150 Grit - Double Bar	DSX2-120/150



DOUBLE BAR TRAPEZOIDS MEDIUM BOND (BLACK)

6 Grit - Double Bar	DSM-6
16/20 Grit - Double Bar	DSM-16/20
30/40 Grit - Double Bar	DSM-30/40
60/80 Grit - Double Bar	DSM-60/80
120/150 Grit - Double Bar	DSM-120/150



DOUBLE BAR TRAPEZOIDS 1X-EXTREME SOFT BOND (ORANGE)

16/20 Grit - Double Bar	DSX1-16/20
30/40 Grit - Double Bar	DSX1-30/40
60/80 Grit - Double Bar	DSX1-60/80
120/150 Grit - Double Bar	DSX1-120/150



DOUBLE BAR TRAPEZOIDS 3X-EXTREME SOFT BOND (GRAY)

6 Grit - Double Bar	DSX3-6
16/20 Grit - Double Bar	DSX3-16/20
30/40 Grit - Double Bar	DSX3-30/40
60/80 Grit - Double Bar	DSX3-60/80
120/150 Grit - Double Bar	DSX3-120/150



DOUBLE BAR TRAPEZOIDS SOFT BOND (BLUE)

16/20 Grit - Double Bar	DSS-16/20
30/40 Grit - Double Bar	DSS-30/40
60/80 Grit - Double Bar	DSS-60/80
120/150 Grit - Double Bar	DSS-120/150



NEW

DEATH TRAP CAP CUTTER TRAPEZOID ULTRA SOFT BOND (GOLD)

16/20 Grit - Death Trap	SCC-16/20
30/40 Grit - Death Trap	SCC-30/40



Triple Segment design for increased production

- 16 and 30 Grit
- Known as the "Cap Killer"
- Designed for opening up and removing the concrete cap on the hardest concretes
- Works great for first cut
- 7, 8, 9, on MOHS
- Fits multiple floor machines
- Proprietary bond for ultra hard concrete

DOUBLE ARROW TRAPEZOIDS

- Segment designed to rip and tear what is in front of it while segment also grinds the floor below it
- Can do two steps in one remove & grind



DOUBLE ARROW HARD BOND (RED)

16/20 Grit - Double Arrow	TAHV-16/20
30/40 Grit - Double Arrow	TAHV-30/40



DOUBLE ARROW 2X-EXTREME SOFT BOND (YELLOW)

16/20 Grit - Double Arrow	TAX2-16/20
30/40 Grit - Double Arrow	TAX2-30/40



DOUBLE ARROW MEDIUM BOND (BLACK)

16/20 Grit - Double Arrow	TAMV-16/20
30/40 Grit - Double Arrow	TAMV-30/40



DOUBLE ARROW 3X-EXTREME SOFT BOND (GRAY)

16/20 Grit - Double Arrow	TAX3-16/20
30/40 Grit - Double Arrow	TAX3-30/40

ARROW SEG 3" METAL BOND WITH PIN ON BACK PLATE



3" ARROW SEGMENTS HARD BOND (RED)

3" - 16/20 Grit - Arrow Segments	A3-H16/20
3" - 30/40 Grit - Arrow Segments	A3-H30/40



3" ARROW SEGMENTS MEDIUM BOND (BLACK)

3" 16/20 Grit - Arrow Segments	A3-M16/20
3" 30/40 Grit - Arrow Segments	A3-M30/40



3" ARROW SEGMENTS 2X-EXTREME SOFT BOND (YELLOW)

3" 16/20 Grit - Arrow Segments	A3-S16/20
3" 30/40 Grit - Arrow Segments	A3-S30/40



NEW



3" DEATH TRAP ROUND ULTRA SOFT BOND (GOLD)

3" 16/20 Grit - Death Trap Round	3SCC-16/20
3" 30/40 Grit - 3" Death Trap Round	3SCC-16/20

SURFACE PREPARATION

3" ROUND METAL BOND

WDS | WORLD DIAMOND SOURCE® BOND RECOMMENDATIONS



3" ROUND METAL BOND PLATES WITH BACK PLATE PIN



**3" - 5 BEVELED SEGMENTS
HARD BOND (RED)**

16/20 Grit	5BS3-H16/20
30/40 Grit	5BS3-H30/40
60/80 Grit	5BS3-H60/80
120/150 Grit	5BS3-H120/150



**3" - 5 BEVELED SEGMENTS
MEDIUM BOND (BLACK)**

16/20 Grit	5BS3-M16/20
30/40 Grit	5BS3-M30/40
60/80 Grit	5BS3-M60/80
120/150 Grit	5BS3-M120/150



**3" - 5 BEVELED SEGMENTS
2X-EXTREME SOFT BOND (YELLOW)**

16/20 Grit	5BS3-SS16/20
30/40 Grit	5BS3-SS30/40
60/80 Grit	5BS3-SS60/80
120/150 Grit	5BS3-SS120/150



**3" - 5 BEVELED SEGMENTS
3X-EXTREME SOFT BOND (GRAY)**

16/20 Grit	5BS3-XS16/20
30/40 Grit	5BS3-XS30/40
60/80 Grit	5BS3-XS60/80
120/150 Grit	5BS3-XS120/150



**3" - 8 BEVELED SEGMENTS
HARD BOND (RED)**

16/20 Grit	8BS3-H16/20
30/40 Grit	8BS3-H30/40
60/80 Grit	8BS3-H60/80
120/150 Grit	8BS3-H120/150

**3" - 8 BEVELED SEGMENTS
MEDIUM BOND (BLACK)**

16/20 Grit	8BS3-M16/20
30/40 Grit	8BS3-M30/40
60/80 Grit	8BS3-M60/80
120/150 Grit	8BS3-M120/150

**3" - 8 BEVELED SEGMENTS
SOFT BOND (YELLOW)**

16/20 Grit	8BS3-S16/20
30/40 Grit	8BS3-S30/40
60/80 Grit	8BS3-S60/80
120/150 Grit	8BS3-S120/150

**3" - 8 BEVELED SEGMENTS
3X-EXTREME SOFT BOND (GRAY)**

16/20 Grit	8BS3-XS16/20
30/40 Grit	8BS3-XS30/40
60/80 Grit	8BS3-XS60/80
120/150 Grit	8BS3-XS120/150



**3" WITH VELCRO - 8 BEVELED SEGMENTS
MEDIUM BOND (BLACK)**

16/20 Grit	V8BS-M16/20
30/40 Grit	V8BS-M30/40
60/80 Grit	V8BS-M60/80
120/150 Grit	V8BS-M120/150



**3" - 10 BEVELED SEGMENTS
HARD BOND (RED)**

16/20 Grit	10SEG3-H16/20
30/40 Grit	10SEG3-H30/40
60/80 Grit	10SEG3-H60/80
120/150 Grit	10SEG3-H120/150



**3" - 10 BEVELED SEGMENTS
MEDIUM BOND (BLACK)**

16/20 Grit	10SEG3-M16/20
30/40 Grit	10SEG3-M30/40
60/80 Grit	10SEG3-M60/80
120/150 Grit	10SEG3-M120/150

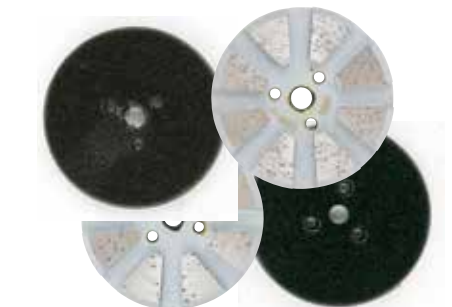

**3" WITH VELCRO - 8 BEVELED SEGMENTS
3X-EXTREME SOFT BOND (GRAY)**

16/20 Grit	V8BS-XS16/20
30/40 Grit	V8BS-XS30/40
60/80 Grit	V8BS-XS60/80
120/150 Grit	V8BS-XS120/150

WDS GRIT SYSTEMS



SURFACE PREPARATION

PROPRIETARY TOOLING

PROPRIETARY TOOLING FOR HTC®



**HTC® STYLE DOUBLE BAR
MEDIUM BOND (BLACK)**

HTC Style Double Bar - Medium Bond - 16/20 Grit	DSMH-16/20
HTC Style Double Bar - Medium Bond - 30/40 Grit	DSMH-30/40
HTC Style Double Bar - Medium Bond - 60/80 Grit	DSMH-60/80
HTC Style Double Bar - Medium Bond - 120/150 Grit	DSMH-120/150



**HTC® STYLE DOUBLE RHOMBUS W/ XL
CRUSHED PCD SEGMENTS**

HTC Style Double Rhombus w/ XL Crushed PDC Segments **RSPCDHTC**



HTC® STYLE GODZILLA XL PCD

HTC Style Godzilla XL PCD - Left **PCDXL-HTC**
HTC Style Godzilla XL PCD - Right **PCDXR-HTC**



**HTC® STYLE DOUBLE BAR
2X-EXTREME SOFT BOND (YELLOW)**

HTC Style Double Bar - 2X-Extreme Soft Bond - 16/20 Grit	DSX2H-16/20
HTC Style Double Bar - 2X-Extreme Soft Bond - 30/40 Grit	DSX2H-30/40
HTC Style Double Bar - 2X-Extreme Soft Bond - 60/80 Grit	DSX2H-60/80
HTC Style Double Bar - 2X-Extreme Soft Bond - 120/150 Grit	DSX2H-120/150



**HTC STYLE UNIVERSAL
TRAP HOLDER
HSHOE**

HTC Style Universal Trap Holder
TRAPSCREW

PROPRIETARY TOOLING FOR HUSQVARNA®



**HUSQVARNA® STYLE DOUBLE SEGMENT PCD
W/ STABILIZER BAR - HARD BOND (RED)**

Double Segment - Hard Bond - 16/20 Grit	HSH-16/20
Double Segment - Hard Bond - 30/40 Grit	HSH-30/40
Double Segment - Hard Bond - 60/80 Grit	HSH-60/80
Double Segment - Hard Bond - 120/150 Grit	HSH-120/150

**HUSQVARNA® STYLE DOUBLE SEGMENT PCD
W/ STABILIZER BAR - 2X EXTREME SOFT BOND (YELLOW)**

Double Segment - 2X-Extreme Soft Bond - 16/20 Grit	HSX2-16/20
Double Segment - 2X-Extreme Soft Bond - 30/40 Grit	HSX2-30/40
Double Segment - 2X-Extreme Soft Bond - 60/80 Grit	HSX2-60/80
Double Segment - 2X-Extreme Soft Bond - 120/150 Grit	HSX2-120/150

**HUSQVARNA® STYLE DOUBLE SEGMENT PCD
W/ STABILIZER BAR - MEDIUM (BLACK)**

Double Segment - Medium Bond - 16/20 Grit	HSM-16/20
Double Segment - Medium Bond - 30/40 Grit	HSM-30/40
Double Segment - Medium Bond - 60/80 Grit	HSM-60/80
Double Segment - Medium Bond - 120/150 Grit	HSM-120/150



**PCD-HUS-S
PCD shoe**

WDS | WORLD DIAMOND SOURCE.
BOND RECOMMENDATIONS



WDS GRIT SYSTEMS

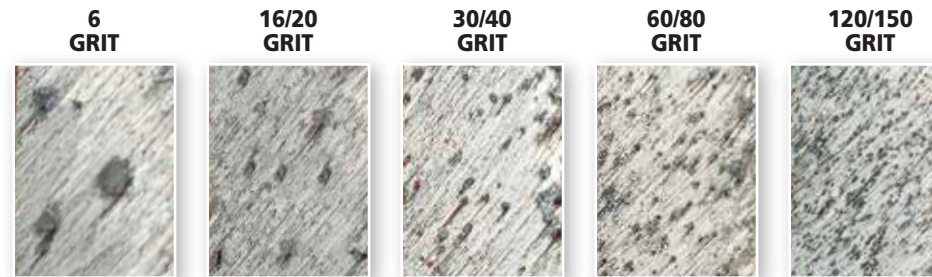

PROPRIETARY TOOLING FOR LAVINA®



LAVINA® STYLE DOUBLE ROUND
HARD BOND (RED)

Lavina Style Double Round - Hard Bond - 60/80 Grit **LRSH-60/80**



LAVINA® STYLE - WITH SMALL SHARP EDGE PCD'S

Lavina Style Small Sharp Edge PCD's - Left **PCDS-L**
 Lavina Style Small Sharp Edge PCD's - Right **PCDS-R**



LAVINA® STYLE DOUBLE ARROW
MEDIUM BOND (BLACK)

Double Arrow - Medium bond - 16/20 Grit **LTAM-16/20**
 Double Arrow - Medium bond - 30/40 Grit **LTAM-30/40**

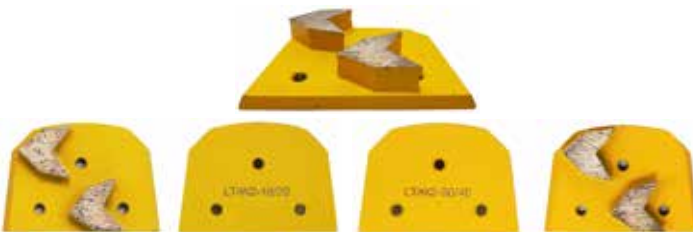

LAVINA® STYLE DOUBLE ARROW
2X-EXTREME SOFT BOND (YELLOW)

Double Arrow - 2X-Extreme Soft bond - 16/20 Grit **LTAX2-16/20**
 Double Arrow - 2X-Extreme Soft bond - 30/40 Grit **LTAX2-30/40**



LAVINA® STYLE DEATH TRAP
ULTRA SOFT BOND (GOLD)

Lavina Style Death Trap - 16/20 Grit **SCCL-16/20**
 Lavina Style Death Trap - 30/40 Grit **SCCL-30/40**



Lavina Style Double Rhombus w/ XL Crushed PCD Segments **LRSPCD**



LAVINA® STYLE SPEED TRAP

Speed Trap - 30/40 Grit **DOTRAPL**
 Speed Trap - 60/80 Grit **DOTRAP60L**



Lavina Style Universal Trap Holder **LSHOE**



Universal Adapter Screw **TRAPSCREW**

PROPRIETARY TOOLING FOR LAVINA®

LAVINA® STYLE DOUBLE BAR
HARD BOND (RED)

Hard Bond - 16/20 Grit **LSH-16/20**
 Hard Bond - 30/40 Grit **LSH-30/40**
 Hard Bond - 60/80 Grit **LSH-60/80**
 Hard Bond - 120/150 Grit **LSH-120/150**



LAVINA® STYLE DOUBLE BAR
MEDIUM BOND (BLACK)

Medium Bond - 16/20 Grit **LSM-16/20**
 Medium Bond - 30/40 Grit **LSM-30/40**
 Medium Bond - 60/80 Grit **LSM-60/80**
 Medium Bond - 120/150 Grit **LSM-120/150**



LAVINA® STYLE DOUBLE BAR
2X-SOFT BOND (YELLOW)

2X-Extreme Soft Bond - 16/20 Grit **LSX2-16/20**
 2X-Extreme Soft Bond - 30/40 Grit **LSX2-30/40**
 2X-Extreme Soft Bond - 60/80 Grit **LSX2-60/80**
 2X-Extreme Soft Bond - 120/150 Grit **LSX2-120/150**



LAVINA® STYLE MINI-ZILLA
2 PCD'S WITH RHOMBUS CRUSHED PCD

Lavina Style Mini-Zilla - 2 PCD's w/ rhombus crushed PCD - Left **LPCD-L**
 Lavina Style Mini-Zilla 2 PCD's w/ rhombus crushed PCD - Right (propane) **LPCD-R**
 Lavina Style Godzilla xl PCD - Left **LPCDXL-L**
 Lavina Style Godzilla xl PCD - Right (propane) **LPCDXL-R**

PROPRIETARY TOOLING FOR SKANMASKIN®



SKANMASKIN® STYLE DOUBLE SEGMENT
HARD BOND (RED)

Double Segment - Hard Bond - 16/20 Grit **SSH-16/20**
 Double Segment - Hard Bond - 30/40 Grit **SSH-30/40**
 Double Segment - Hard Bond - 60/80 Grit **SSH-60/80**
 Double Segment - Hard Bond - 120/150 Grit **SSH-120/150**

SKANMASKIN® STYLE DOUBLE SEGMENT
MEDIUM BOND (BLACK)

Double Segment - Medium Bond - 16/20 Grit **SSM-16/20**
 Double Segment - Medium Bond - 30/40 Grit **SSM-30/40**
 Double Segment - Medium Bond - 60/80 Grit **SSM-60/80**
 Double Segment - Medium Bond - 120/150 Grit **SSM-120/150**

SKANMASKIN® STYLE DOUBLE SEGMENT
2X-EXTREME SOFT BOND (YELLOW)

Double Segment - 2X-Extreme Soft Bond - 16/20 Grit **SSX2-16/20**
 Double Segment - 2X-Extreme Soft Bond - 30/40 Grit **SSX2-30/40**
 Double Segment - 2X-Extreme Soft Bond - 60/80 Grit **SSX2-60/80**
 Double Segment - 2X-Extreme Soft Bond - 120/150 Grit **SSX2-120/150**



SKANMASKIN® STYLE SEGMENT PCD

PCD Shoe **PCD-SK1**
 PCD Shoe **PCD-SK2**

SURFACE PREPARATION PROPRIETARY TOOLING

WDS | WORLD DIAMOND SOURCE. BOND RECOMMENDATIONS



WDS GRIT SYSTEMS

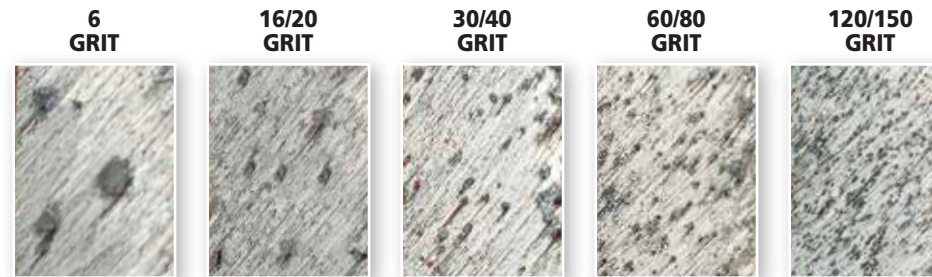

SURFACE PREPARATION PROPRIETARY TOOLING

PROPRIETARY TOOLING FOR STI®

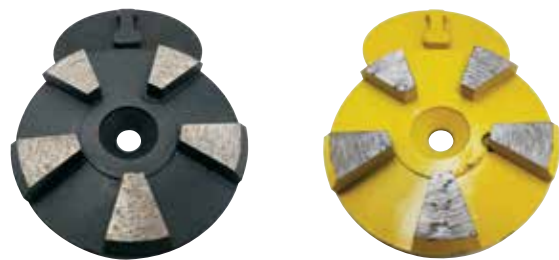

3" STI® STYLE - 5 BEVELED SEGMENTS MEDIUM BOND (BLACK)

3" 5 Beveled Seg Medium Bond - 16/20 Grit	5BSSTI-M16/20
3" 5 Beveled Seg Medium Bond - 30/40 Grit	5BSSTI-M30/40
3" 5 Beveled Seg Medium Bond - 60/80 Grit	5BSSTI-M60/80
3" 5 Beveled Seg Medium Bond - 120/150 Grit	5BSSTI-M120/150

3" STI® STYLE - 5 BEVELED SEGMENTS 2X-EXTREME SOFT BOND (YELLOW)

3" 5 Beveled Seg - 2X-Extreme Soft Bond - 16/20 Grit	5BSSTI-SS16/20
3" 5 Beveled Seg - 2X-Extreme Soft Bond - 30/40 Grit	5BSSTI-SS30/40
3" 5 Beveled Seg - 2X-Extreme Soft Bond - 60/80 Grit	5BSSTI-SS60/80
3" 5 Beveled Seg - 2X-Extreme Soft Bond - 120/150 Grit	5BSSTI-SS120/150



3" STI® STYLE - 8 BEVELED SEGMENTS MEDIUM BOND (BLACK)

3" 8 Beveled Seg Medium Bond - 16/20 Grit	8BSSTI-M16/20
3" 8 Beveled Seg Medium Bond - 30/40 Grit	8BSSTI-M30/40
3" 8 Beveled Seg Medium Bond - 60/80 Grit	8BSSTI-M60/80
3" 8 Beveled Seg Medium Bond - 120/150 Grit	8BSSTI-M120/150

3" STI® STYLE - 8 BEVELED SEGMENTS 2X-EXTREME SOFT BOND (YELLOW)

3" 8 Beveled Seg - 2X-Extreme Soft Bond - 16/20 Grit	8BSSTI-SS16/20
3" 8 Beveled Seg - 2X-Extreme Soft Bond - 30/40 Grit	8BSSTI-SS30/40
3" 8 Beveled Seg - 2X-Extreme Soft Bond - 60/80 Grit	8BSSTI-SS60/80
3" 8 Beveled Seg - 2X-Extreme Soft Bond - 120/150 Grit	8BSSTI-SS120/150



3" STI STYLE - MINI-ZILLA PCD 2X PCD'S W/ RHOMBUS SEGMENT - PIN ON BACK

3" - 2X PCD's w/ Rhombus Segment - Pin on Back - Left	STIPCD-L
3" - 2X PCD's w/ Rhombus Segment - Pin on Back - Right	STIPCD-R



3" STI STYLE - GODZILLA XL PCD W/ RHOMBUS SEGMENT - PIN ON BACK

3" - XL PCD's w/ Rhombus Segment - Pin on Back - Left	STIPCDXL_L
3" - XL PCD's w/ Rhombus Segment - Pin on Back - Right	STIPCDXL_R



3" - 3 XL PCD's w/ Rhombus Crushed PCD Segments **3RSPCDSTI**



DOUBLE BAR TRAPEZOIDS FOR STI® MEDIUM BOND (BLACK)

Double Bar - Medium Bond - 16/20 Grit	DSMSTI-16/20
Double Bar - Medium Bond - 30/40 Grit	DSMSTI-30/40
Double Bar - Medium Bond - 60/80 Grit	DSMSTI-60/80
Double Bar - Medium Bond - 120/150 Grit	DSMSTI-120/150



DOUBLE BAR TRAPEZOIDS FOR STI® 2X-EXTREME SOFT BOND (YELLOW)

Double Bar - 2X-Extreme Soft Bond - 16/20 Grit	DSX2STI-16/20
Double Bar - 2X-Extreme Soft Bond - 30/40 Grit	DSX2STI-30/40
Double Bar - 2X-Extreme Soft Bond - 60/80 Grit	DSX2STI-60/80
Double Bar - 2X-Extreme Soft Bond - 120/150 Grit	DSX2STI-120/150

STI® Style - Universal Trap Holder	TRAPPLATESTI
STI® Style - Universal Adapter Screw	TRAPSCREW

PROPRIETARY TOOLING FOR TERRCO®



SUPER SPEED BAR - LEFT MEDIUM BOND (BLACK)

Super Speed Bar - Medium Bond - 30/40 Grit	SST-30/40-L
Super Speed Bar - Medium Bond - 60/80 Grit	SST-60/80-L
Super Speed Bar - Medium Bond - 120/150 Grit	SST-120/150-L

SUPER SPEED BAR - RIGHT MEDIUM BOND (BLACK)

Super Speed Bar - Medium Bond - 30/40 Grit	SST-30/40-R
Super Speed Bar - Medium Bond - 60/80 Grit	SST-60/80-R
Super Speed Bar - Medium Bond - 120/150 Grit	SST-120/150-R



3" TERRCO® STYLE - 5 BEVELED SEGMENTS MEDIUM BOND (BLACK)

3" 5 Beveled Seg Medium Bond - 16/20 Grit	5BSTER-M16/20
3" 5 Beveled Seg Medium Bond - 30/40 Grit	5BSTER-M30/40
3" 5 Beveled Seg Medium Bond - 60/80 Grit	5BSTER-M60/80
3" 5 Beveled Seg Medium Bond - 120/150 Grit	5BSTER-M120/150



3" TERRCO® STYLE - 5 BEVELED SEGMENTS 2X-EXTREME SOFT BOND (YELLOW)

3" 5 Beveled Seg - 2X-Extreme Soft Bond - 16/20 Grit	5BSTER-SS16/20
3" 5 Beveled Seg - 2X-Extreme Soft Bond - 30/40 Grit	5BSTER-SS30/40
3" 5 Beveled Seg - 2X-Extreme Soft Bond - 60/80 Grit	5BSTER-SS60/80
3" 5 Beveled Seg - 2X-Extreme Soft Bond - 120/150 Grit	5BSTER-SS120/150



3" TERRCO STYLE - 3 XL RHOMBUS CRUSHED PCD SEGMENTS
3" Terrco Style XL Rhombus Crushed PCD Seg **3RSPCDTER**



TERRCO STYLE UNIVERSAL TRAP HOLDER

Terrco Style Universal Trap Holder **TRAPPLATETER**



3" TERRCO® STYLE - 8 BEVELED SEGMENTS MEDIUM BOND (BLACK)

3" 8 Beveled Seg Medium Bond - 16/20 Grit	8BSTER-M16/20
3" 8 Beveled Seg Medium Bond - 30/40 Grit	8BSTER-M30/40
3" 8 Beveled Seg Medium Bond - 60/80 Grit	8BSTER-M60/80
3" 8 Beveled Seg Medium Bond - 120/150 Grit	8BSTER-M120/150



3" TERRCO® STYLE - 8 BEVELED SEGMENTS 2X-EXTREME SOFT BOND (YELLOW)

3" 8 Beveled Seg - 2X-Extreme Soft Bond - 16/20 Grit	8BSTER-SS16/20
3" 8 Beveled Seg - 2X-Extreme Soft Bond - 30/40 Grit	8BSTER-SS30/40
3" 8 Beveled Seg - 2X-Extreme Soft Bond - 60/80 Grit	8BSTER-SS60/80
3" 8 Beveled Seg - 2X-Extreme Soft Bond - 120/150 Grit	8BSTER-SS120/150

SURFACE PREPARATION PROPRIETARY TOOLING

WDS | WORLD DIAMOND SOURCE. BOND RECOMMENDATIONS



SURFACE PREPARATION GRINDING & RESIN BLOCKS

PROPRIETARY TOOLING FOR WERKMASTER®



WERKMASTER® STYLE - DOUBLE SEGMENT HARD BOND (RED)

Double Segment - Hard Bond - 16/20 Grit	WMH-16/20
Double Segment - Hard Bond - 30/40 Grit	WMH-30/40
Double Segment - Hard Bond - 60/80 Grit	WMH-60/80
Double Segment - Hard Bond - 120/150 Grit	WMH-120/150

WERKMASTER® STYLE - DOUBLE SEGMENT MEDIUM BOND (BLACK)

Double Segment - Medium Bond - 16/20 Grit	WMM-16/20
Double Segment - Medium Bond - 30/40 Grit	WMM-30/40
Double Segment - Medium Bond - 60/80 Grit	WMM-60/80
Double Segment - Medium Bond - 120/150 Grit	WMM-120/150

WERKMASTER® STYLE - DOUBLE SEGMENT 2X-EXTREME SOFT BOND (YELLOW)

Double Segment - 2X-Extreme Soft Bond - 16/20 Grit	WMXS-16/20
Double Segment - 2X-Extreme Soft Bond - 30/40 Grit	WMXS-30/40
Double Segment - 2X-Extreme Soft Bond - 60/80 Grit	WMXS-60/80
Double Segment - 2X-Extreme Soft Bond - 120/150 Grit	WMXS-120/150



WERKMASTER® STYLE - SINGLE SEGMENT MEDIUM BOND (BLACK)

Single Segment Medium Bond - 16/20 Grit	WM1-M16/20
Single Segment Medium Bond - 30/40 Grit	WM1-M30/40

WERKMASTER® STYLE - SINGLE SEGMENT 2X-EXTREME SOFT BOND (YELLOW)

Single Segment 2X-Extreme Soft Bond - 16/20 Grit	WM1-XS16/20
Single Segment 2X-Extreme Soft Bond - 30/40 Grit	WM1-XS30/40



WERKMASTER® STYLE - 3 SHARP EDGE PCD'S - NO STABILIZER

PCD Plate Thin Coatings - Left Turn	WPCD3-L
PCD Plate Thin Coatings - Right Turn	WPCD3-R



WERKMASTER® STYLE - SINGLE PCD'S - NO STABILIZER

PCD Plate Thick Coatings - Left Turn	WPCDX-L
PCD Plate Thick Coatings - Right Turn	WPCDX-R

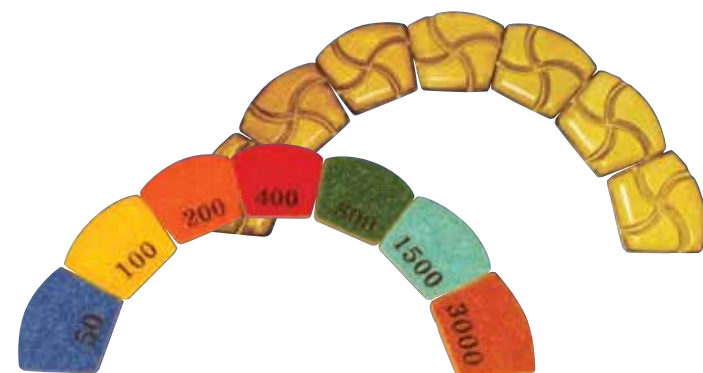

WERKMASTER® STYLE RESIN PADS

Resin Pads - 50 Grit	WDR-50
Resin Pads - 100 Grit	WDR-100
Resin Pads - 200 Grit	WDR-200
Resin Pads - 400 Grit	WDR-400
Resin Pads - 800 Grit	WDR-800
Resin Pads - 1500 Grit	WDR-1500
Resin Pads - 3000 Grit	WDR-3000
Resin Pads - 50 Grit Resin / Metal Hybrid	WDRH-50
Resin Pads - 100 Grit Resin / Metal Hybrid	WDRH-100
Resin Pads - 200 Grit Resin / Metal Hybrid	WDRH-200

GRINDING BLOCKS - METAL BOND



These new design Blocks come as an assembly & rubber slides in and held securely by pin.

GRINDING BLOCKS SEGMENTED - SOFT BOND

Grinding Block - 30/40 Grit	GBS-30/40
Grinding Block - 50/60 Grit	GBS-50/60
Grinding Block - 80/100 Grit	GBS-80/100

GRINDING BLOCKS SEGMENTED - MEDIUM BOND

Grinding Block - 30/40 Grit	GBM-30/40
-----------------------------	------------------

GRINDING BLOCK - PCD DIAMOND



For removal of epoxy coatings with long life and high production.

Grinding Block PCD Diamond	GBPCD
----------------------------	--------------

GRINDING BLOCKS - CARBIDE CHUNK



GRINDING BLOCKS CARBIDE CHUNK - 8 GRIT

For removal of epoxy coatings without the cost of PCD and the gumming up of metal bond.

Grinding Block - 8 Grit	GBCARB-08
-------------------------	------------------

RESIN BLOCKS

Our block segments are much bigger diameter 50mm x 10mm x 10mm

RESIN BLOCKS

These new resin polishing pad will enable you to use EDCO, Husquarna and Diamond products grinding machines to start polishing concrete floors (wet/dry) without the need of purchasing expensive polishing machines.



Resin Blocks - 50 Grit	RB-50
Resin Blocks - 100 Grit	RB-100
Resin Blocks - 200 Grit	RB-200
Resin Blocks - 400 Grit	RB-400
Resin Blocks - 800 Grit	RB-800
Resin Blocks - 1500 Grit	RB-1500

SURFACE PREPARATION GRINDING HEADS

GRINDING HEADS

Our grinding heads are available with 10 or 20 segments, and their professional grade makes them superior to most others on the market.



GRINDING PLATES PREMIUM Universal Bolt Pattern

- 10" Grinding Plate - 10 Segments **GH10-10H**
- 10" Grinding Plate - 20 Segments **GH10-20H**

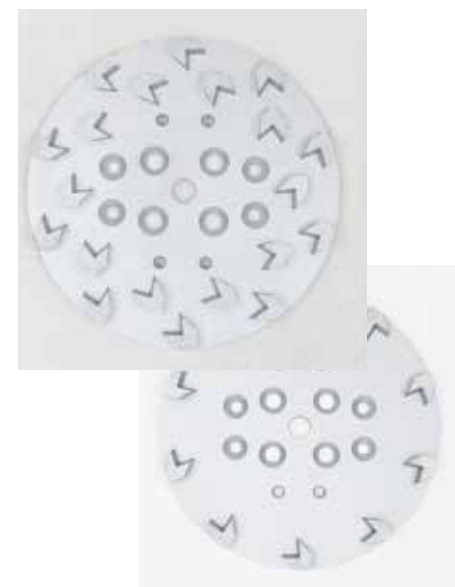

10" GRINDING PLATE ARROW SEGMENTS - 30/40 GRIT Universal Bolt Pattern

- 10" Grinding Plate - 10 Arrow Seg **AGH10-10E**
- 10" Grinding Plate - 20 Arrow Seg **AGH10-20E**



10" GRINDING PLATES PRO GRADE - 30/40 GRIT Universal Bolt Pattern

- 10" Grinding Plate - 10 Segments **GH10-10**
- 10" Grinding Plate - 20 Segments **GH10-20**



10" GRINDING PLATE ARROW SEGMENTS PRO GRADE - 30/40 GRIT Universal Bolt Pattern

- 10" Grinding Plate - 10 Arrow Seg **AGH10-10**
- 10" Grinding Plate - 20 Arrow Seg **AGH10-20**



10" GRINDING PLATE - 6 RHOMBUS CRUSHED PCD'S Universal Bolt Pattern

- 10" - Grinding Plate - 6 Rhombus Seg **PCD10-10**

This PCD technology we have adapted within segments for the fastest most productive way to remove coatings and glue with the smaller grinding machines that use grinding heads.

10" POLISHING FLOOR PADS

For polishing with smaller machines for grinding that can adapt to polishing with our new velcro backer plates.



10" BACKER PLATE FOR USE OF RESINS ON SMALLER GRINDING MACHINES

- 10" Velcro Backing Plate **BP10**



10" RESIN DRY POLISHING FLOOR PADS

- 10" Resin Floor Pad - 50 Grit **FP10-50**
- 10" Resin Floor Pad - 100 Grit **FP10-100**
- 10" Resin Floor Pad - 200 Grit **FP10-200**
- 10" Resin Floor Pad - 400 Grit **FP10-400**
- 10" Resin Floor Pad - 800 Grit **FP10-800**
- 10" Resin Floor Pad - 1500 Grit **FP10-1500**
- 10" Resin Floor Pad - 3000 Grit **FP10-3000**

SURFACE PREPARATION DIAMOND PLUG SYSTEM

DIAMOND PLUG SYSTEM FOR TERRCO & STI®

With our proven bond formulas and high quality diamonds our Diamond Plugs get the job done right. Available in various styles, grits, and bonds.



DIAMOND PLUG HARD BOND (RED)

- 2" - 16/20 Grit - Diamond Plug **DPH2-16/20**
- 2" - 30/40 Grit - Diamond Plug **DPH2-30/40**
- 2" - 60/80 Grit - Diamond Plug **DPH2-60/80**
- 2" - 120/150 Grit - Diamond Plug **DPH2-120/150**

DIAMOND PLUG MEDIUM BOND (BLACK)

- 2" - 16/20 Grit - Diamond Plug **DP2-16/20**
- 2" - 30/40 Grit - Diamond Plug **DP2-30/40**
- 2" - 60/80 Grit - Diamond Plug **DP2-60/80**
- 2" - 120/150 Grit **DP2-120/150**



EXCHANGEABLE VELCRO PLATE FOR PLUG SYSTEM TO RUN RESINS

- 3" x 5/8" - 11 Plate **VPLUG**



3" ARROW SEGMENTS DIAMOND FOR PLUG - MEDIUM BOND (BLACK)

- 3" - 16/20 Grit **DPA3-16/20**
- 3" - 30/40 Grit **DPA3-30/40**



3" ARROW SEGMENTS DIAMOND FOR PLUG - HARD BOND (RED)

- 3" - 16/20 Grit **DPA3-H16/20**
- 3" - 30/40 Grit **DPA3-H30/40**



EXCHANGEABLE PLUG WITH BOLT

- 1 1/3" PLUG w/ Bolt **PLUG 1**
- 2" PLUG w/ Bolt **PLUG 2**



3" TURBO DIAMOND PLUG PLATE HARD BOND (RED)

- 3" - 16/20 Grit - Plug Plate **DPTH3-16/20**
- 3" - 30/40 Grit - Plug Plate **DPTH3-30/40**
- 3" - 60/80 Grit - Plug Plate **DPTH3-60/80**



3" TURBO DIAMOND PLUG PLATE MEDIUM BOND (BLACK)

- 3" - 16/20 Grit - Plug Plate **DPT3-16/20**
- 3" - 30/40 Grit - Plug Plate **DPT3-30/40**
- 3" - 60/80 Grit - Plug Plate **DPT3-60/80**



3" 8 BEVELED SEGMENTS - (THREADED)

- 3" - 16/20 Grit **DPBS3-16/20**
- 3" - 30/40 Grit **DPBS3-30/40**
- 3" - 60/80 Grit **DPBS3-60/80**
- 3" - 120/150 Grit **DPBS3-120/150**

FIBER PHENOLIC PADS



Our Fiber Phenolic Pads are perfect for grinding and polishing of cementitious coatings (overlays) and concrete. These extremely flexible pads are also good for working when there are minor dips or low spots when grinding and polishing concrete. These pads are easy to attach on Velcro holders under any style grinding machines. These pads are SUPER-FAST, and outperform pucks up to 3x faster.

- New puck design for optimal grinding results
- New bond formula gives up to 3x Speed performance
- Can grind all types of cementitious floor coverings and concrete floors
- Large surface area for maximum production
- Designed to prevent scratching while polishing concrete
- Available in four sizes: 5" / 7" / 9" / 10" / 11"

FIBER PHENOLIC FLOOR PADS

5" PADS

5" Phenolic Floor Pad - 30 Grit	DSXL5-30
5" Phenolic Floor Pad - 50 Grit	DSXL5-50
5" Phenolic Floor Pad - 100 Grit	DSXL5-100
5" Phenolic Floor Pad - 200 Grit	DSXL5-200
5" Phenolic Floor Pad - 400 Grit	DSXL5-400
5" Phenolic Floor Pad - 800 Grit	DSXL5-800
5" Phenolic Floor Pad - 1500 Grit	DSXL5-1500
5" Phenolic Floor Pad - 3000 Grit	DSXL5-3000

7" PADS

7" Phenolic Floor Pad - 30 Grit	DSXL7-30
7" Phenolic Floor Pad - 50 Grit	DSXL7-50
7" Phenolic Floor Pad - 100 Grit	DSXL7-100
7" Phenolic Floor Pad - 200 Grit	DSXL7-200
7" Phenolic Floor Pad - 400 Grit	DSXL7-400
7" Phenolic Floor Pad - 800 Grit	DSXL7-800
7" Phenolic Floor Pad - 1500 Grit	DSXL7-1500
7" Phenolic Floor Pad - 3000 Grit	DSXL7-3000

9" PADS

9" Phenolic Floor Pad - 30 Grit	DSXL9-30
9" Phenolic Floor Pad - 50 Grit	DSXL9-50
9" Phenolic Floor Pad - 100 Grit	DSXL9-100
9" Phenolic Floor Pad - 200 Grit	DSXL9-200
9" Phenolic Floor Pad - 400 Grit	DSXL9-400
9" Phenolic Floor Pad - 800 Grit	DSXL9-800
9" Phenolic Floor Pad - 1500 Grit	DSXL9-1500
9" Phenolic Floor Pad - 3000 Grit	DSXL9-3000

10" PADS

10" Phenolic Floor Pad - 30 Grit	DSXL10-30
10" Phenolic Floor Pad - 50 Grit	DSXL10-50
10" Phenolic Floor Pad - 100 Grit	DSXL10-100
10" Phenolic Floor Pad - 200 Grit	DSXL10-200
10" Phenolic Floor Pad - 400 Grit	DSXL10-400
10" Phenolic Floor Pad - 800 Grit	DSXL10-800
10" Phenolic Floor Pad - 1500 Grit	DSXL10-1500
10" Phenolic Floor Pad - 3000 Grit	DSXL10-3000

11" PADS

11" Phenolic Floor Pad - 30 Grit	DSXL11-30
11" Phenolic Floor Pad - 50 Grit	DSXL11-50
11" Phenolic Floor Pad - 100 Grit	DSXL11-100
11" Phenolic Floor Pad - 200 Grit	DSXL11-200
11" Phenolic Floor Pad - 400 Grit	DSXL11-400
11" Phenolic Floor Pad - 800 Grit	DSXL11-800
11" Phenolic Floor Pad - 1500 Grit	DSXL11-1500
11" Phenolic Floor Pad - 3000 Grit	DSXL11-3000

SUPERNOVA PADS

The SUPERNOVA Signature Series sets the new gold standard for ultra shine. The thick 12mm pad gives you tremendous life, while our proprietary formula promotes award winning shines and production rates that are second to none.

SUPERNOVA PADS

- Newest bridge between metals and resins
- Proprietary bond for fast cuts and tighter scratches
- Combination of ceramic, copper, and resin up to 200 Grit
- Resin only 400 Grit and up
- Our 400 Grit achieves higher DOI in lower Grits achieves higher level of shine faster
- Foam cushion between velcro & tool
- 30, 50, 100, 200 – Wet / Dry
- 400, 800, 1500, 3000 – Comes wet only or dry only



3" Hybrid Floor Pad - Wet/Dry - 30 Grit	FPX3-30
3" Hybrid Floor Pad - Wet/Dry - 50 Grit	FPX3-50
3" Hybrid Floor Pads - Wet/Dry - 100 Grit	FPX3-100
3" Hybrid Floor Pads - Wet/Dry - 200 Grit	FPX3-200
3" Hybrid Floor Pads - Dry Only - 400 Grit	FPX3-400
3" Hybrid Floor Pads - Dry Only - 800 Grit	FPX3-800
3" Hybrid Floor Pads - Dry Only - 1500 Grit	FPX3-1500
3" Hybrid Floor Pads - Dry Only - 3000 Grit	FPX3-3000



3" - SUPERNOVA RESIN FLOOR PAD - WET ONLY

3" Hybrid Resin Floor Pad - Wet Only - 400 Grit	SUPERFPX3-400
3" Hybrid Resin Floor Pad - Wet Only - 800 Grit	SUPERFPX3-800
3" Hybrid Resin Floor Pad - Wet Only - 1500 Grit	SUPERFPX3-1500
3" Hybrid Resin Floor Pad - Wet Only - 3000 Grit	SUPERFPX3-3000



Supernova Hybrid Floor Pads WET/DRY (STONE ONLY)

3" Supernova Hybrid Floor Pad - Wet/Dry - 30 Grit	FPS3-30
3" Supernova Hybrid Floor Pad - Wet/Dry - 50 Grit	FPS3-50
3" Supernova Hybrid Floor Pad - Wet/Dry - 100 Grit	FPS3-100
3" Supernova Hybrid Floor Pad - Wet/Dry - 200 Grit	FPS3-200
3" Supernova Resin Floor Pad - Dry Only - 400 Grit	FPS3-400
3" Supernova Resin Floor Pad - Dry Only - 800 Grit	FPS3-800
3" Supernova Resin Floor Pad - Dry Only - 1500 Grit	FPS3-1500
3" Supernova Resin Floor Pad - Dry Only - 3000 Grit	FPS3-3000

SURFACE PREPARATION FLOOR POLISHING

TRANSITIONAL TOOLING



PREMIUM CERAMIC BONDED PADS FOR FLOOR MACHINES

3" Ceramic Floor Pad - 30 Grit	CRX3-30
3" Ceramic Floor Pad - 50 Grit	CRX3-50
3" Ceramic Floor Pad - 100 Grit	CRX3-100
3" Ceramic Floor Pad - 200 Grit	CRX3-200
3" Ceramic Floor Pad - 400 Grit	CRX3-400

6 DOT - PRO SERIES

Hybrid Formula - resin dot polishing pads



6 DOT - PRO SERIES DRY HYBRID FLOOR PADS

For aggressive fast polishing. No plastic cavity to leave residue on floors. Full resin/metal mold for the best dot pad made

2 3/8" 6 Dot Dry Pad - 50 Grit	DRDP-50
2 3/8" 6 Dot Dry Pad - 100 Grit	DRDP-100
2 3/8" 6 Dot Dry Pad - 200 Grit	DRDP-200
2 3/8" 6 Dot Dry Pad - 400 Grit	DRDP-400
2 3/8" 6 Dot Dry Pad - 800 Grit	DRDP-800
2 3/8" 6 Dot Dry Pad - 1500 Grit	DRDP-1500
2 3/8" 6 Dot Dry Pad - 3000 Grit	DRDP-3000

FLOWER TYPE - PRO SERIES

Dry Hybrid Resin/Metal Polishing Pad for Floor Machines



FLOWER HYBRID FLOOR PADS LONG LIFE FORMULA

3" Hybrid Floor Pad - 30 Grit	HRPNRM3-30
3" Hybrid Floor Pad - 50 Grit	HRPNRM3-50
3" Hybrid Floor Pad - 100 Grit	HRPNRM3-100
3" Hybrid Floor Pad - 200 Grit	HRPNRM3-200
3" Resin Floor Pad - 400 Grit	HRPNEW3-400
3" Resin Floor Pad - 800 Grit	HRPNEW3-800
3" Resin Floor Pad - 1500 Grit	HRPNEW3-1500
3" Resin Floor Pad - 3000 Grit	HRPNEW3-3000



FLOWER FLOOR PADS SPEED FORMULA

For aggressive fast polish. - 6mm

3" Hybrid Floor Pad - 30 Grit	HRP3-30
3" Hybrid Floor Pad - 50 Grit	HRP3-50
3" Hybrid Floor Pad - 100 Grit	HRP3-100
3" Hybrid Floor Pad - 200 Grit	HRP3-200
3" Resin Floor Pad - 400 Grit	HRP3-400
3" Resin Floor Pad - 800 Grit	HRPNEW3-800
3" Resin Floor Pad - 1500 Grit	HRPNEW3-1500
3" Resin Floor Pad - 3000 Grit	HRPNEW3-3000

PIE TYPE - PRO SERIES

Dry Hybrid Resin/Metal Polishing Pad for Floor Machines



PRO HYBRID FLOOR PAD LONG LIFE FORMULA

3" Hybrid Floor Pad - 30 Grit	HRX3-30
3" Hybrid Floor Pad - 50 Grit	HRX3-50
3" Hybrid Floor Pad - 100 Grit	HRX3-100
3" Hybrid Floor Pad - 200 Grit	HRX3-200
3" Resin Floor Pad - 400 Grit	HRX3-400
3" Resin Floor Pad - 800 Grit	HRXNEW3-800
3" Resin Floor Pad - 1500 Grit	HRXNEW3-1500
3" Resin Floor Pad - 3000 Grit	HRXNEW3-3000

PRO FLOOR PAD - SPEED FORMULA

For aggressive fast polish. - 10mm

3" Hybrid Floor Pad - 30 Grit	HRXSF3-30
3" Hybrid Floor Pad - 50 Grit	HRXSF3-50
3" Hybrid Floor Pad - 100 Grit	HRXSF3-100
3" Hybrid Floor Pad - 200 Grit	HRXSF3-200
3" Resin Floor Pad - 400 Grit	HRXSF3-400
3" Resin Floor Pad - 800 Grit	HRXNEW3-800
3" Resin Floor Pad - 1500 Grit	HRXNEW3-1500
3" Resin Floor Pad - 3000 Grit	HRXNEW3-3000

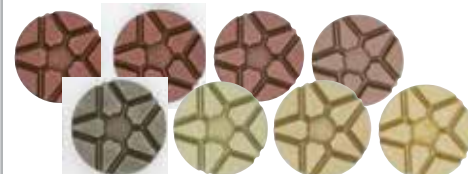

STAR TYPE - SUPER PRO SERIES

Special formula - extra long life -12mm

3" Floor Pad - 30 Grit	STAR3-30
3" Floor Pad - 50 Grit	STAR3-50
3" Floor Pad - 100 Grit	STAR3-100
3" Floor Pad - 200 Grit	STAR3-200
3" Floor Pad - 400 Grit	STAR3-400
3" Floor Pad - 800 Grit	STAR3-800
3" Floor Pad - 1500 Grit	STAR3-1500
3" Floor Pad - 3000 Grit	STAR3-3000

VELCRO BACKED RESIN PADS FOR FLOOR MACHINES - PREMIUM GRADE



PREMIUM DRY RESIN PADS FOR FLOOR MACHINES HARD BOND - 10MM THICK

3" Premium Dry Resin Floor Pad - 50 Grit	DPP3-50
3" Premium Dry Resin Floor Pad - 100 Grit	DPP3-100
3" Premium Dry Resin Floor Pad - 200 Grit	DPP3-200
3" Premium Dry Resin Floor Pad - 400 Grit	DPP3-400
3" Premium Dry Resin Floor Pad - 800 Grit	DPP3-800
3" Premium Dry Resin Floor Pad - 1500 Grit	DPP3-1500
3" Premium Dry Resin Floor Pad - 3000 Grit	DPP3-3000



FLOW - FLOOR DRY RESIN PADS 3MM THICK - FL07 BOND

3" Resin Floor Pad - 50 Grit	FL07-50
3" Resin Floor Pad - 100 Grit	FL07-100
3" Resin Floor Pad - 200 Grit	FL07-200
3" Resin Floor Pad - 400 Grit	FL07-400
3" Resin Floor Pad - 800 Grit	FL07-800
3" Resin Floor Pad - 1500 Grit	FL07-1500
3" Resin Floor Pad - 3000 Grit	FL07-3000

SURFACE PREPARATION FLOOR POLISHING

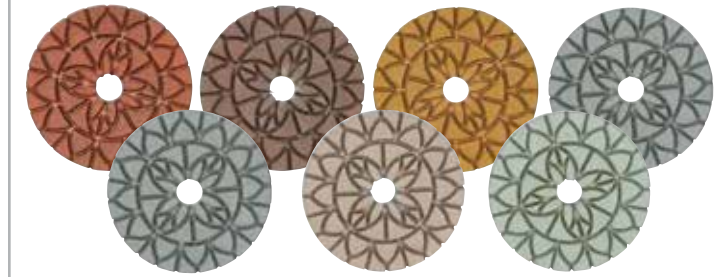

HYBRID FLOWER HAND PADS - DRY/WET SOFT BOND 3MM THICK HYBRID FORMULA

3" Hybrid Flower Hand Pads - Dry/Wet - 50 Grit	DPC3-50
3" Hybrid Flower Hand Pads - Dry/Wet - 100 Grit	DPC3-100
3" Hybrid Flower Hand Pads - Dry/Wet - 200 Grit	DPC3-200
3" Resin Flower Hand Pads - Dry/Wet - 400 Grit	DPC3-400
3" Resin Flower Hand Pads - Dry/Wet - 800 Grit	DPC3-800
3" Resin Flower Hand Pads - Dry/Wet - 1500 Grit	DPC3-1500
3" Resin Flower Hand Pads - Dry/Wet - 3000 Grit	DPC3-3000

5" Hybrid Flower Hand Pads - Dry/Wet - 50 Grit	DPC5-50
5" Hybrid Flower Hand Pads - Dry/Wet - 100 Grit	DPC5-100
5" Hybrid Flower Hand Pads - Dry/Wet - 200 Grit	DPC5-200
5" Resin Flower Hand Pads - Dry/Wet - 400 Grit	DPC5-400
5" Resin Flower Hand Pads - Dry/Wet - 800 Grit	DPC5-800
5" Resin Flower Hand Pads - Dry/Wet - 1500 Grit	DPC5-1500
5" Resin Flower Hand Pads - Dry/Wet - 3000 Grit	DPC5-3000

7" Hybrid Flower Hand Pads - Dry/Wet - 50 Grit	DPC7-50
7" Hybrid Flower Hand Pads - Dry/Wet - 100 Grit	DPC7-100
7" Hybrid Flower Hand Pads - Dry/Wet - 200 Grit	DPC7-200
7" Resin Flower Hand Pads - Dry/Wet - 400 Grit	DPC7-400
7" Resin Flower Hand Pads - Dry/Wet - 800 Grit	DPC7-800
7" Resin Flower Hand Pads - Dry/Wet - 1500 Grit	DPC7-1500
7" Resin Flower Hand Pads - Dry/Wet - 3000 Grit	DPC7-3000

SURFACE PREPARATION

PRO FIBER DIAMOND PADS

SURFACE PREPARATION

SIGNATURE SERIES CUP WHEELS

PRO FIBER DIAMOND PADS

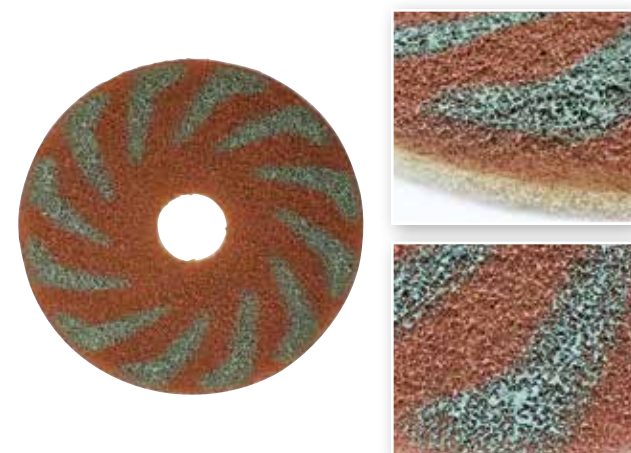

PRO FIBER SIGNATURE SERIES DIAMOND PADS DOUBLE SPRAYED FOR EXTREME LIFE

17" Diamond Floor Pad Extreme Life - 400 Grit	FDPX-17-400
17" Diamond Floor Pad Extreme Life - 800 Grit	FDPX-17-800
17" Diamond Floor Pad Extreme Life - 1500 Grit	FDPX-17-1500
17" Diamond Floor Pad Extreme Life - 3000 Grit	FDPX-17-3000
21" Diamond Floor Pad Extreme Life - 400 Grit	FDPX-21-400
21" Diamond Floor Pad Extreme Life - 800 Grit	FDPX-21-800
21" Diamond Floor Pad Extreme Life - 1500 Grit	FDPX-21-1500
21" Diamond Floor Pad Extreme Life - 3000 Grit	FDPX-21-3000
27" Diamond Floor Pad Extreme Life - 400 Grit	FDPX-27-400
27" Diamond Floor Pad Extreme Life - 800 Grit	FDPX-27-800
27" Diamond Floor Pad Extreme Life - 1500 Grit	FDPX-27-1500
27" Diamond Floor Pad Extreme Life - 3000 Grit	FDPX-27-3000



DIAMOND FIBER PADS WITH SPRAY DIAMOND 17", 21" AND 27"

17" Diamond Fiber Floor Pad - 400 Grit	FDP-17-400
17" Diamond Fiber Floor Pad - 800 Grit	FDP-17-800
17" Diamond Fiber Floor Pad - 1500 Grit	FDP-17-1500
17" Diamond Fiber Floor Pad - 3000 Grit	FDP-17-3000
21" Diamond Fiber Floor Pad - 400 Grit	FDP-21-400
21" Diamond Fiber Floor Pad - 800 Grit	FDP-21-800
21" Diamond Fiber Floor Pad - 1500 Grit	FDP-21-1500
21" Diamond Fiber Floor Pad - 3000 Grit	FDP-21-3000
27" Diamond Fiber Floor Pad - 400 Grit	FDP-27-400
27" Diamond Fiber Floor Pad - 800 Grit	FDP-27-800
27" Diamond Fiber Floor Pad - 1500 Grit	FDP-27-1500
27" Diamond Fiber Floor Pad - 3000 Grit	FDP-27-3000

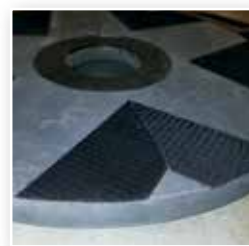

3/4" VELCRO BACKED FOAM FLOOR PAD

15" Velcro Backed Foam Floor Pad	EVA-15
17" Velcro Backed Foam Floor Pad	EVA-17
20" Velcro Backed Foam Floor Pad	EVA-20
21" Velcro Backed Foam Floor Pad	EVA-21
24" Velcro Backed Foam Floor Pad	EVA-24
27" Velcro Backed Foam Floor Pad	EVA-27

SIGNATURE SERIES CUP WHEELS



WHEEL OF DEATH

The "Wheel of Death" is one of the fastest and most aggressive cup wheels for the hardest of concrete. It's 16 Grit diamond grinds the hardest concrete out there. For guaranteed speed and production, this is the cup wheel to use.

WHEEL OF DEATH 16/20 GRIT

4" Wheel of Death (Non Threaded) - 16/20 Grit	SCUP4-1
5" Wheel of Death (Non Threaded) - 16/20 Grit	SCUP5-1
5" Wheel of Death (Threaded) - 16/20 Grit	SCUPT5-1
7" Wheel of Death (Non Threaded) - 16/20 Grit	SCUP7-1
7" Wheel of Death (Threaded) - 16/20 Grit	SCUPT7-1



HALO WHEEL

A Polisher's Dream - This Ultra-Fast Cup Wheel is designed to grind the hardest concrete. It is your "Go-to" cup wheel for quick first cuts. With Superior 30 Grit Diamonds and our proven Bond Formula, its performance and life will exceed your expectations.



HALO WHEEL 30/40 GRIT

4" Halo Wheel (Threaded) - 30/40 Grit	SCUPT4-1/30
5" Halo Wheel (Non Threaded) - 30/40 Grit	SCUP5-1/30
5" Halo Wheel (Threaded) - 30/40 Grit	SCUPT5-1/30
7" Halo Wheel (Non Threaded) - 30/40 Grit	SCUP7-1/30
7" Halo Wheel (Threaded) - 30/40 Grit	SCUPT7-1/30



SURFACE PREPARATION

PCD CUP WHEELS

PCD CUP WHEELS

WDS uses the highest quality PCD to give you maximum life and performance. "PCD" Polycrystalline diamond is made with very high pressures and temperatures. Available with different sized PCDs for different levels of aggression.



PCD CUP, THIN COATINGS

4" x 7/8" - 5/8" 11 Threads with 9 small PCD	PCDST-4
5" x 7/8" - 5/8" 11 Threads with 12 small PCD	PCDST-5
7" x 7/8" - 5/8" 11 Threads with 18 small PCD	PCDST-7



PCD CUP, THICK COATINGS

4" x 7/8" - 5/8" 11 Threads with 5 large PCD	PCDDT-4
5" x 7/8" - 5/8" 11 Threads with 6 large PCD	PCDDT-5
7" x 7/8" - 5/8" 11 Threads with 9 large PCD	PCDDT-7



PCD CUP WHEEL WITH 24 SMALL PCD

5" PCD Cup Wheel w/ 24 Small PDCs	PCDCW5-24
7" PCD Cup Wheel w/ 24 Small PDCs	PCDCW7-24



PCD CUP, EXTRA AGGRESSIVE - THICK COATINGS

5" x 7/8" - 5/8" 11 Threads with 5 large PCD	PCDXT-5
7" x 7/8" - 5/8" 11 Threads with 6 large PCD	PCDXT-7

SURFACE PREPARATION

ARROW CUP WHEELS

ARROW CUP WHEELS

- Segment designed to rip and tear what is in front of it while segment also grinds the floor below it
- Can do two steps in one - remove and grind
- Great all purpose segment design



5" ARROW SEGMENT CUP WHEEL PRO GRADE

5" Arrow Segment Cup Wheel (Non Threaded) Pro-Grade - 16 Grit	ACW5-HJ
5" Arrow Segment Cup Wheel (Threaded) Pro-Grade - 16 Grit	ACWT5-HJ



7" ARROW SEGMENT CUP WHEEL PRO GRADE

7" Arrow Segment Cup Wheel (Non Threaded) Pro-Grade - 16 Grit	ACW7-HJ
7" Arrow Segment Cup Wheel (Threaded) Pro-Grade - 16 Grit	ACWT7-HJ



5" ARROW SEGMENT CUP WHEEL PREMIUM

5" Arrow Segment Cup Wheel (Non Threaded) 30 Grit	ACW5-4N
5" Arrow Segment Cup Wheel (Threaded) 30 Grit	ACWT5-4N



7" ARROW SEGMENT CUP WHEEL PREMIUM

7" Arrow Segment Cup Wheel (Non Threaded) 30 Grit	ACW7-4N
7" Arrow Segment Cup Wheel (Threaded) 30 Grit	ACWT7-4N

SURFACE PREPARATION CUP WHEELS

SURFACE PREPARATION CUP WHEELS

CUP WHEELS

Our cup wheels provide fast stock removal with minimum dust. Choose single row for roughing and double row for finishing of concrete. We also have swirly cup wheels for concrete floors. Turbo cup wheels are available in fine, medium and coarse Grits. We stock many others for any specific application.



4" SINGLE ROW CUP WHEEL

4" Single Row Cup Wheel (Non-Threaded) Pro-Grade **CWS4-7B**

4" Single Row Cup Wheel (Threaded) Pro-Grade **CWST4-7B**

5" SINGLE ROW CUP WHEEL

5" Single Row Cup Wheel (Non-Threaded) Pro-Grade **CWS5-7B**

5" Single Row Cup Wheel (Threaded) Pro-Grade **CWST5-7B**

7" SINGLE ROW CUP WHEEL

7" Single Row Cup Wheel (Non Threaded) Pro-Grade **CWS7-7B**

7" Single Row Cup Wheel (Threaded) Pro-Grade **CWST7-7B**

4" DOUBLE ROW CUP WHEEL

4" Double Row Cup Wheel (Non-Threaded) Pro-Grade **CWD4-7B**

4" Double Row Cup Wheel (Threaded) Pro-Grade **CWDT4-7B**

4" Double Row Cup Wheel (Threaded) Heavy Duty Grade **CWDT4**

5" DOUBLE ROW CUP WHEEL

5" Double Row Cup Wheel (Non-Threaded) Pro-Grade **CWD5-7B**

5" Double Row Cup Wheel (Threaded) Pro-Grade **CWDT5-7B**

7" DOUBLE ROW CUP WHEEL

7" Double Row Cup Wheel (Non Threaded) Pro-Grade **CWD7-7B**

7" Double Row Cup Wheel (Threaded) Pro-Grade **CWDT7-7B**



4" SWIRLY CUP WHEEL

4" Swirly Cup Wheel w/ 10 Segments (Non Threaded) Pro-Grade **SCW4-7B/10**

4" Swirly Cup Wheel w/ 10 Segments (Threaded) Pro-Grade **SCWT4-7B/10**

4" Swirly Cup Wheel w/ 8 Segments (Threaded) Heavy Duty Grade **SCWT4-8**

4.5" SWIRLY CUP WHEEL

4.5" Swirly Cup Wheel w/ 18 Segments (Threaded) Pro-Grade **SCWT4.5-1/18**

4.5" Swirly Cup Wheel w/ 8 Segments (Non-Threaded) Heavy Duty Grade **SCW4.5-8**

4.5" Swirly Cup Wheel w/ 8 Segments (Threaded) Heavy Duty Grade **SCWT4.5-8**

4.5" Swirly Cup Wheel w/ 18 Segments (Non-threaded) Heavy Duty Grade **SCW4.5-18**

4.5" Swirly Cup Wheel w/ 8 Segments (Threaded) Heavy Duty Grade **SCWT4.5-18**

5" SWIRLY CUP WHEEL

5" Swirly Cup Wheel w/ 12 Segments (Threaded) Pro-Grade **SCWT5-7B/12**

5" Swirly Cup Wheel w/ 9 Segments (Non Threaded) Heavy Duty Grade **SCW5-9**

5" Swirly Cup Wheel w/ 9 Segments (Threaded) Heavy Duty Grade **SCWT5-9**

5" Swirly Cup Wheel w/ 18 Segments (Non Threaded) Heavy Duty Grade **SCW5-18**

5" Swirly Cup Wheel w/ 18 Segments (Threaded) Heavy Duty Grade **SCWT5-18**

7" SWIRLY CUP WHEEL

7" Swirly Cup Wheel w/ 12 Segments (Non Threaded) Pro-Grade **SCW7-7B/12**

7" Swirly Cup Wheel w/ 12 Segments (Threaded) Pro-Grade **SCWT7-7B/12**

7" Swirly Cup Wheel w/ 24 Segments (Non Threaded) Pro-Grade **SCW7-7B/24**

7" Swirly Cup Wheel w/ 24 Segments (Threaded) Pro-Grade **SCWT7-7B/24**

7" Swirly Cup Wheel w/ 12 Segments (Non Threaded) Heavy Duty Grade **SCW7-12**

7" Swirly Cup Wheel w/ 12 Segments (Threaded) Heavy Duty Grade **SCWT7-12**

7" Swirly Cup Wheel w/ 24 Segments (Non Threaded) Heavy Duty Grade **SCW7-24**

7" Swirly Cup Wheel w/ 24 Segments (Threaded) Heavy Duty Grade **SCWT7-24**

CUP WHEELS

Our cup wheels provide fast stock removal with minimum dust. Choose single row for roughing and double row for finishing of concrete. We also have swirly cup wheels for concrete floors. Turbo cup wheels are available in fine, medium and coarse Grits. We stock many others for any specific application.



3.5" SUPER FAN CUP WHEELS

3.5" Super Fan Cup **FC3.5-4N**

5" SUPER FAN CUP WHEEL

5" Super Fan Cup Wheel - Soft Bond (Non Threaded) **FCS5-4N**

5" Super Fan Cup Wheel - Soft Bond (Threaded) **FCST5-4N**

7" SUPER FAN CUP WHEEL

7" Super Fan Cup - Soft Bond - (Non Threaded) **FCST7-4N**

7" Super Fan Cup - Soft Bond - (Threaded) **FCST7-4N**



4" T-SEGMENTED CUP WHEEL

4" T-Seg Cup Wheel (Threaded) **TSCWT4-HJ**

5" T-SEGMENTED CUP WHEEL

5" T-Seg Cup Wheel (Threaded) **TSCWT5-HJ**

5" T-Seg Cup Wheel (Non-Threaded) **TSCW5-HJ**

7" T-SEGMENTED CUP WHEEL

7" T-Seg Cup Wheel (Non Threaded) **TSCW7-HJ**

7" T-Seg Cup Wheel (Threaded) **TSCWT7-HJ**

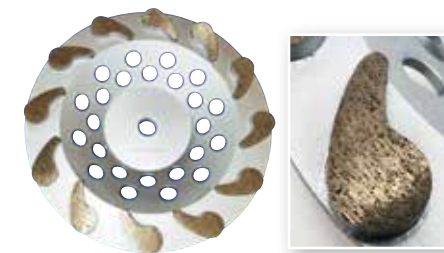

7" TEAR DROP CUP WHEEL

7" Tear Drop Cup Wheel (Threaded) - 60 Grit **TDCWT7-60/80**

7" Tear Drop Cup Wheel (Threaded) - 120 Grit **TDCWT7-120/150**

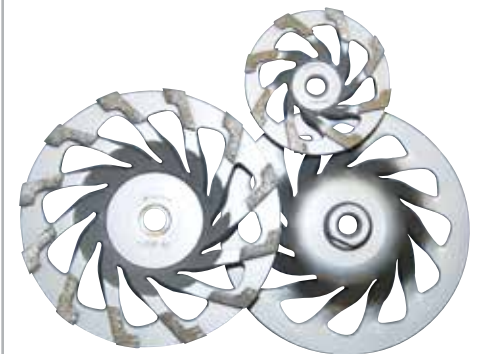

4" L-SEGMENTED CUP WHEEL

4" L-Seg Cup Wheel (Threaded) **LSCWT4-HJ**

5" L-SEGMENTED CUP WHEEL

5" L-Seg Cup Wheel (Threaded) **LSCWT5-HJ**

5" L-Seg Cup Wheel (Non Threaded) **LSCW5-HJ**

7" L-SEGMENTED CUP WHEEL

7" L-Seg Cup Wheel (Non Threaded) **LSCW7-HJ**

7" L-Seg Cup Wheel (Threaded) **LSCWT7-HJ**



CUP WHEEL FOR HILTI®

6" Spike-Seg Cup Wheel - for Hilti® Only **CW6-4N**

6" L-Seg Cup Wheel - for Hilti® Only **LCW6-4N**

SURFACE PREPARATION CUP WHEELS

WDS GRIT SYSTEMS



SURFACE PREPARATION CUP WHEELS

CUP WHEELS



PRO TURBO ALUMINUM CUP WHEEL

Aluminum Back, Dry/Wet

4" Threaded - Coarse	TCWCT4-1
4" Threaded - Medium	TCWMT4-1
4" Threaded - Fine	TCWFT4-1
5" Threaded - Coarse	TCWCT5-1
5" Non Threaded - Coarse	TCWCS-1
5" Threaded - Medium	TCWMT5-1
5" Non Threaded - Medium	TCWM5-1
5" Threaded - Fine	TCWFT5-1
5" Non Threaded - Fine	TCWF5-1
6" Threaded - Coarse	TCWCT6-1
7" Threaded - Coarse	TCWCT7-1
7" Non Threaded - Coarse	TCWC7-1
7" Threaded - Medium	TCWMT7-1
7" Non Threaded - Medium	TCWM7-1
7" Threaded - Fine	TCWFT7-1
7" Non Thread - Fine	TCWF7-1

COURSE: 40/50 GRIT
MEDIUM: 50/60 GRIT
FINE: 80/100 GRIT



PRO TURBO CUP WHEELS

4" Threaded - Coarse	TCWCT4-5Q
4" Threaded - Medium	TCWMT4-5Q
4" Threaded - Fine	TCWFT4-5Q
5" Threaded - Coarse	TCWCT5-5Q
5" Threaded - Medium	TCWMT5-5Q
5" Threaded - Fine	TCWFT5-5Q
7" Threaded - Coarse	TCWCT7-5Q
7" Threaded - Medium	TCWMT7-5Q
7" Threaded - Fine	TCWFT7-5Q

COURSE: 30/40 GRIT
MEDIUM: 50/60 GRIT
FINE: 80/100 GRIT



METAL DOT CUP WHEELS

5" Metal Dot Cup Wheel	MDCW-5
5" Metal Dot Cup Wheel Threaded	MDCWT-5
7" Metal Dot Cup Wheel	MDCW-7
7" Metal Dot Cup Wheel Threaded	MDCWT-7

30/40 GRIT

CUP WHEELS

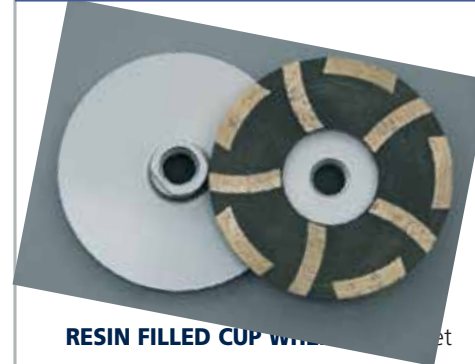

RESIN FILLED CUP WHEEL

4" x 5/8" 11 Threads Medium	RCWMT4-5Q
4" x 5/8" 11 Threads Coarse	RCWCT4-5Q



5" COVE CUP WHEELS

5" Cove Cup Wheel - Vacuum Brazed (Threaded) - 30 Grit	VBCOVET-5/C
5" Cove Cup Wheel - Vacuum Brazed (Threaded) - 60 Grit	VBCOVET-5/M
5" Cove Cup Wheel - Vacuum Brazed (Threaded) - 120 Grit	VBCOVET-5/F



6" COVE CUP WHEELS

6" Cove Cup Wheel (Non Threaded) - 30mm Radius - Coarse	CCW-6
6" Cove Cup Wheel (Threaded) - 30mm Radius - Coarse	CCWT-6



7" VACUUM BRAZED FLAT WHEELS

7" Vacuum Brazed Flat Wheel (Threaded) - 30 Grit	VBFWTC7-1
7" Vacuum Brazed Flat Wheel (Threaded) - 60 Grit	VBFWTM7-1
7" Vacuum Brazed Flat Wheel (Threaded) - 120 Grit	VBFWTF7-1



4" FLAT VACUUM BRAZED WHEELS

Dry/Wet

4" x 5/8" x 11 Course - 30/40 Grit	VBFWTC4-1
4" x 5/8" x 11 Medium - 50/60 Grit	VBFWTM4-1
4" x 5/8" x 11 Fine - 80/100 Grit	VBFWTF4-1
7" x 5/8" x 11 Course - 30/40 Grit	VBFWTC7-1
7" x 5/8" x 11 Medium - 50/60 Grit	VBFWTM7-1
7" x 5/8" x 11 Fine - 80/100 Grit	VBFWTF7-1



4" CONVEX VACUUM BRAZED WHEELS

Dry/Wet

4" x 5/8" x 11 Course 30/40 Grit	VBCXTC4-1
4" x 5/8" x 11 Medium 50/60 Grit	VBCXTM4-1
4" x 5/8" x 11 Fine 80/100 Grit	VBCXTF4-1



METAL BOND SPEED DOT PADS "FLEX DOTS"

3" Speed Dot -Metal Dot Diamond Pad - 30 Grit	MFDOT3-30
3" Speed Dot -Metal Dot Diamond Pad - 60 Grit	MFDOT3-60
5" Speed Dot -Metal Dot Diamond Pad - 30 Grit	MFDOT5-30
5" Speed Dot -Metal Dot Diamond Pad - 60 Grit	MFDOT5-60
5" Speed Dot -Metal Dot Diamond Pad - 150 Grit	MFDOT5-150
5" Speed Dot -Metal Dot Diamond Pad - 300 Grit	MFDOT5-300
7" Speed Dot -Metal Dot Diamond Pad - 30 Grit	MFDOT7-30
7" Speed Dot -Metal Dot Diamond Pad - 60 Grit	MFDOT7-60
7" Speed Dot -Metal Dot Diamond Pad - 150 Grit	MFDOT7-150
7" Speed Dot -Metal Dot Diamond Pad - 300 Grit	MFDOT7-300

SURFACE PREPARATION TRANSITIONAL CUP WHEELS & GRINDING DISCS

CERAMIC TRANSITIONAL CUP WHEELS

Ceramic bonded cup wheels for grinding edges during the concrete polishing process. The ceramic give a very fine scratch pattern and provide a superior shine. Eliminates the need to use the metal bonded cup wheels that may leave a deeper scratch pattern and gouge the concrete. These professional grade ceramic cup wheels come in 5" and 7" with a 5/8"-11 thread in 5 grits to match your polishing process.



THREADED CERAMIC CUP WHEELS

5" Ceramic Cup Wheel Threaded - 30 Grit	TCW5-30
5" Ceramic Cup Wheel Threaded - 50 Grit	TCW5-50
5" Ceramic Cup Wheel Threaded - 100 Grit	TCW5-100
5" Ceramic Cup Wheel Threaded - 200 Grit	TCW5-200
5" Ceramic Cup Wheel Threaded - 400 Grit	TCW5-400
<hr/>	
7" Ceramic Cup Wheel Threaded - 30 Grit	TCW7-30
7" Ceramic Cup Wheel Threaded - 50 Grit	TCW7-50
7" Ceramic Cup Wheel Threaded - 100 Grit	TCW7-100
7" Ceramic Cup Wheel Threaded - 200 Grit	TCW7-200
7" Ceramic Cup Wheel Threaded - 400 Grit	TCW7-400



TRANSITIONAL CUP WHEELS

5" Ceramic Cup Wheel Threaded - 30 Grit	CEW5-30
5" Ceramic Cup Wheel Threaded - 50 Grit	CEW5-50
5" Ceramic Cup Wheel Threaded - 100 Grit	CEW5-100
5" Ceramic Cup Wheel Threaded - 200 Grit	CEW5-200
<hr/>	
7" Ceramic Cup Wheel Threaded - 30 Grit	CEW7-30
7" Ceramic Cup Wheel Threaded - 50 Grit	CEW7-50
7" Ceramic Cup Wheel Threaded - 100 Grit	CEW7-100
7" Ceramic Cup Wheel Threaded - 200 Grit	CEW7-200

GRINDING DISCS

CONCRETE GRINDING DISCS



CONCRETE GRINDING DISCS

4 1/2" x 7/8" - 8 Grit	GRD4.5-1/8
4 1/2" x 7/8" - 16 Grit	GRD4.5-1
4 1/2" x 7/8" - 24 Grit	GRD4.5-1/24
4 1/2" x 7/8" - 36 Grit	GRD4.5-1/36
7" x 7/8" - 8 Grit	GRD7-1/8
7" x 7/8" - 16 Grit	GRD7-1
7" x 7/8" - 24 Grit	GRD7-1/24
7" x 7/8" - 36 Grit	GRD7-1/36
7/8" to 5/8" 11 Threads - Adapter	AGD-1

SURFACE PREPARATION HAND POLISHING

MAGIC ERASER EDGE PADS

- 5" and 7"
- 50, 100, 200, 400, 800, 1500, 3000 Grits
- Production Pads
- Gets out scratches faster than anything on the market
- Great for when production is key to tighten up scratches fast
- Dry Only



MAGIC ERASER HONEYCOMB POLISHING PADS DRY ONLY

5" Polishing Pad - Dry - 50 Grit	DPHW5-50
5" Polishing Pad - Dry - 100 Grit	DPHW5-100
5" Polishing Pad - Dry - 200 Grit	DPHW5-200
5" Polishing Pad - Dry - 400 Grit	DPHW5-400
5" Polishing Pad - Dry - 800 Grit	DPHW5-800
5" Polishing Pad - Dry - 1500 Grit	DPHW5-1500
5" Polishing Pad - Dry - 3000 Grit	DPHW5-3000

7" Polishing Pad - Dry - 50 Grit	DPHW7-50
7" Polishing Pad - Dry - 100 Grit	DPHW7-100
7" Polishing Pad - Dry - 200 Grit	DPHW7-200
7" Polishing Pad - Dry - 400 Grit	DPHW7-400
7" Polishing Pad - Dry - 800 Grit	DPHW7-800
7" Polishing Pad - Dry - 1500 Grit	DPHW7-1500
7" Polishing Pad - Dry - 3000 Grit	DPHW7-3000

HONEYCOMB PADS



HONEYCOMB POLISHING PADS DRY ONLY

Our dry pads are handy when you need to polish concrete when water isn't accessible. These work great and leave a beautiful shine.

5" Polishing Pad - Dry - 50 Grit	DPHEC5-50
5" Polishing Pad - Dry - 100 Grit	DPHEC5-100
5" Polishing Pad - Dry - 200 Grit	DPHEC5-200
5" Polishing Pad - Dry - 400 Grit	DPHEC5-400
5" Polishing Pad - Dry - 800 Grit	DPHEC5-800
5" Polishing Pad - Dry - 1500 Grit	DPHEC5-1500
5" Polishing Pad - Dry - 3000 Grit	DPHEC5-3000

SUPERNOVA PADS - WET / DRY

The SUPERNOVA edge pads are our Signature Series resin polishing pads designed to work with the SUPERNOVA ULTRA SERIES transitional pads. These high quality pads match Grit for Grit and produce the same ultra shine. These pads are great for corner grinding and honing for use with hand held grinder.

- Designed to Match our 3in SUPERNOVA Pads
- Proprietary Formula
- ULTRA High Resolution Shine
- Available in 5in or 7in



SUPERNOVA PADS

5" Hybrid Pad Wet/Dry - 30 Grit	FPHH5-30	7" Hybrid Pad Wet/Dry - 30 Grit	FPHH7-30
5" Hybrid Pad Wet/Dry - 50 Grit	FPHH5-50	7" Hybrid Pad Wet/Dry - 50 Grit	FPHH7-50
5" Hybrid Pad Wet/Dry - 100 Grit	FPHH5-100	7" Hybrid Pad Wet/Dry - 100 Grit	FPHH7-100
5" Hybrid Pad Wet/Dry - 200 Grit	FPHH5-200	7" Hybrid Pad Wet/Dry - 30 Grit	FPHH7-200
5" Resin Pad Dry Only - 400 Grit	FPHH5-400	7" Resin Pad Dry Only - 400 Grit	FPHH7-400
5" Resin Pad Dry Only - 800 Grit	FPHH5-800	7" Resin Pad Dry Only - 800 Grit	FPHH7-800
5" Resin Pad Dry Only - 1500 Grit	FPHH5-1500	7" Resin Pad Dry Only - 1500 Grit	FPHH7-1500
5" Resin Pad Dry Only - 3000 Grit	FPHH5-3000	7" Resin Pad Dry Only - 3000 Grit	FPHH7-3000

SURFACE PREPARATION HAND POLISHING

SURFACE PREPARATION HAND POLISHING

POLISHING PADS

We inventory a comprehensive range of pads for any and every polishing need. Dry or wet, hand held or floor machines; whatever the application, look no further.



PRO TULIP TYPE POLISHING PADS

Metal/Resin Formula

- Life Pads
- Hybrid on lower Grits – up to 200
- 400 Grit up - Resin Only
- Wet or Dry use

3" 30 Grit	DPC3-30
3" 50 Grit	DPC3-50
3" 100 Grit	DPC3-100
3" 200 Grit	DPC3-200
3" 400 Grit	DPC3-400
3" 800 Grit	DPC3-800
3" 1500 Grit	DPC3-1500
3" 3000 Grit	DPC3-3000



5" 30 Grit	DPC5-30
5" 50 Grit	DPC5-50
5" 100 Grit	DPC5-100
5" 200 Grit	DPC5-200
5" 400 Grit	DPC5-400
5" 800 Grit	DPC5-800
5" 1500 Grit	DPC5-1500
5" 3000 Grit	DPC5-3000

7" 30 Grit	DPC7-30
7" 50 Grit	DPC7-50
7" 100 Grit	DPC7-100
7" 200 Grit	DPC7-200
7" 400 Grit	DPC7-400
7" 800 Grit	DPC7-800
7" 1500 Grit	DPC7-1500
7" 3000 Grit	DPC7-3000

PREMIUM DRY PADS FOR GRINDERS AND POLISHERS



PREMIUM POLISHING PADS WET ONLY (CERAMIC)

These pads are designed for wet polishing of concrete on low and variable speed grinders.

5" Polishing Pad - Wet - 50 Grit	PP5/50-7B
5" Polishing Pad - Wet - 100 Grit	PP5/100-7B
5" Polishing Pad - Wet - 200 Grit	PP5/200-7B
5" Polishing Pad - Wet - 400 Grit	PP5/400-7B
5" Polishing Pad - Wet - 800 Grit	PP5/800-7B
5" Polishing Pad - Wet - 1500 Grit	PP5/1500-7B
5" Polishing Pad - Wet - 3000 Grit	PP5/3000-7B



ELECTROPLATED FOAM BLOCK HAND PAD

4" x 2 1/4" x 7/8" Hand Pad - 50 Grit	HP-50
4" x 2 1/4" x 7/8" Hand Pad - 100 Grit	HP-100
4" x 2 1/4" x 7/8" Hand Pad - 200 Grit	HP-200
4" x 2 1/4" x 7/8" Hand Pad - 400 Grit	HP-400
4" x 2 1/4" x 7/8" Hand Pad - 800 Grit	HP-800
4" x 2 1/4" x 7/8" Hand Pad - 1500 Grit	HP-1500
4" x 2 1/4" x 7/8" Hand Pad - 3000 Grit	HP-3000



HYBRID FLOWER RING PAD

7" Hybrid Flower Ring Pad - 30 Grit	RP7-30
7" Hybrid Flower Ring Pad - 50 Grit	RP7-50
7" Hybrid Flower Ring Pad - 100 Grit	RP7-100
7" Hybrid Flower Ring Pad - 200 Grit	RP7-200
7" Resin Flower Ring Pad - 400 Grit	RP7-400
7" Resin Flower Ring Pad - 800 Grit	RP7-800
7" Resin Flower Ring Pad - 1500 Grit	RP7-1500
7" Resin Flower Ring Pad - 3000 Grit	RP7-3000

TRIANGLE POLISHING PAD - ELECTROPLATED



SUPERNOVA TRIANGLE PADS

Triangle Polishing Pad Electroplated - 60 Grit	TPE-60
Triangle Polishing Pad Electroplated - 100 Grit	TPE-100
Triangle Polishing Pad Electroplated - 200 Grit	TPE-200
Triangle Polishing Pad Electroplated - 400 Grit	TPE-400
Triangle Polishing Pad Resin - 800 Grit	TPR-800
Triangle Polishing Pad Resin - 1500 Grit	TPR-1500
Triangle Polishing Pad Resin - 3000 Grit	TPR-3000

ELECTROPLATED FLEX PADS



ELECTROPLATED FLEX PADS

5" Electroplated Pad - 30 Grit	EPFL5-30
5" Electroplated Pad - 70 Grit	EPFL5-70
5" Electroplated Pad - 120 Grit	EPFL5-120
5" Electroplated Pad - 220 Grit	EPFL5-220
5" Electroplated Pad - 400 Grit	EPFL5-400
7" Electroplated Pad - 30 Grit	EPFL7-30
7" Electroplated Pad - 70 Grit	EPFL7-70
7" Electroplated Pad - 120 Grit	EPFL7-120
7" Electroplated Pad - 220 Grit	EPFL7-220
7" Electroplated Pad - 400 Grit	EPFL7-400

BACKING PADS



ALUMINUM VELCRO BACKED PLATE

For Flat Polishing with Velcro Backing – 5/8" - 11 Thread Mount

Inches	
5" Aluminum Velcro Backed Plate	BPA5
7" Aluminum Velcro Backed Plate	BPA7



BACKING PADS THREADED FLEXIBLE RUBBER

For All Polishing with Velcro Backing – 5/8" - 11 Thread Mount

Inches	
3" - Threaded - Flexible Rubber Pad	BP3-F
4" - Threaded - Flexible Rubber Pad	BP4-F
5" - Threaded - Flexible Rubber Pad	BP5-F



BACKING PADS THREADED HARD RUBBER

For Flat Polishing with Velcro Backing – 5/8" - 11 Thread Mount

Inches	
3" - Threaded Hard Rubber Pad	BP3
4" - Threaded Hard Rubber Pad	BP4
5" - Threaded Hard Rubber Pad	BP5
7" - Threaded Hard Rubber Pad	BP7



BACKING PAD- THREADED GREEN FLEX

For All Polishing - Extremely flexible with Velcro Backing - 5/8" - 11 Thread Mount

Inches	
5" - Threaded - Green Flex	GBP-5



BACKING PAD - THREADED EXTRA FLEXIBLE

For All Polishing - thin and flexible with Velcro Backing – 5/8" - 11 Thread Mount

Inches	
5" - Threaded - Extra Flexible	BP5-XFLEX

CUTTING TOOLS FOR SURFACE PREP & POLISH

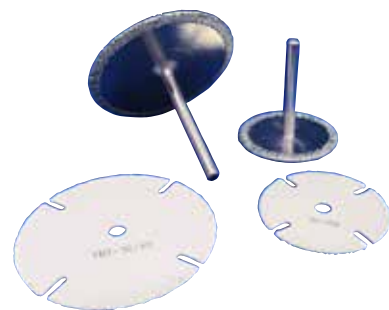

VACUUM BRAZED WHEEL WITH SHANK

1" Vacuum Brazed Wheel with 1/4" Shank - 30/40 Grit	VBS1-30/40
2" Vacuum Brazed Wheel with 1/4" Shank - 30/40 Grit	VBS2-30/40
3" Vacuum Brazed with 1/4" Shank - 30/40 Grit	VBS3-30/40



OMNIVORE® - VACUUM BRAZED SEGMENTED BLADES

4" Omnivore® - Vacuum Brazed	VBS4-7B
4.5" Omnivore® - Vacuum Brazed	VBS4.5-7B
5" Omnivore® - Vacuum Brazed	VBS5-7B
7" Omnivore® - Vacuum Brazed	VBS7-7B
8" Omnivore® - Vacuum Brazed	VBS8-7B
9" Omnivore® - Vacuum Brazed	VBS9-7B
10" Omnivore® - Vacuum Brazed	VBS10-7B



MULTI-CUT & GRIND BLADES THREADED

4" Cut/Grind/Flush Blade - (Threaded)	MCG4-1
4.5" Cut/Grind/Flush Blade - (Threaded)	MCG4.5-1
5" Cut/Grind/Flush Blade - (Threaded)	MCG5-1
7" Cut/Grind/Flush Blade - (Threaded)	MCG7-1

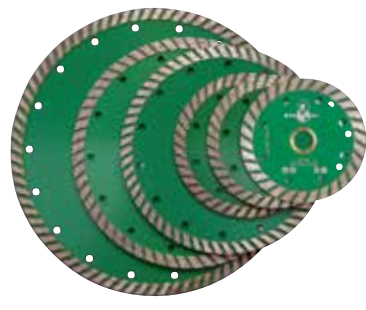

PREMIUM TURBO BLADES

4" Premium Turbo Blade	TX4-4N
4.5" Premium Turbo Blade	TX4.5-4N
5" Premium Turbo Blade	TX5-4N
7" Premium Turbo Blade	TX7-4N
8" Premium Turbo Blade	TX8-4N
9" Premium Turbo Blade	TX9-4N
10" Premium Turbo Blade	TX10-4N



POWER COMBO® - LASER WELDED SEGMENTED BLADES

4" Laser Welded	SP4-5Q
4.5" Laser Welded	SP4.5-5Q
5" Laser Welded	SP5-5Q
7" Laser Welded	SP7-5Q
7" Laser Welded - .125" Thick	SP7-5Q/2
7" Laser Welded - .187" Thick	SP7-5Q/7
8" Laser Welded	SP8-5Q
9" Laser Welded	SP9-5Q
10" Laser Welded	SP10-5Q



10" Laser Welded - .110 Thick	SS10-2
10" Laser Welded - .110 Thick	SP10-2



PREMIUM SEGMENTED BLADES

4" Premium Segmented Blade	SX4-4N
4.5" Premium Segmented Blade	SX4.5-4N
5" Premium Segmented Blade	SX5-4N
7" Premium Segmented Blade	SX7-4N
8" Premium Segmented Blade	SX8-4N
9" Premium Segmented Blade	SX9-4N
10" Premium Segmented Blade	SX10-4N



SUPER TURBO BLADES

4" Super Turbo - (Soft Bond)	STG4-H
4" Super Turbo - (Medium Bond)	STGP4-H
4.5" Super Turbo - (Soft Bond)	STG4.5-H
4.5" Super Turbo - (Medium Bond)	STGP4.5-H
5" Super Turbo - (Soft Bond)	STG5-H
5" Super Turbo - (Medium Bond)	STGP5-H
7" Super Turbo - (Soft Bond)	STG7-H
7" Super Turbo - (Medium Bond)	STGP7-H
8" Super Turbo - (Soft Bond)	STG8-H
8" Super Turbo - (Medium Bond)	STGP8-H
10" Super Turbo - (Soft Bond)	STG10-H
10" Super Turbo - (Medium Bond)	STGP10-H

CUTTING TOOLS FOR SURFACE PREP & POLISH



SILVER BULLET® - LASER WELDED SEGMENTED TURBO BLADE

4" Silver Bullet® - Laser Welded	ST4-1
4.5" Silver Bullet® - Laser Welded	ST4.5-1
5" Silver Bullet - Laser Welded	ST5-1
7" Silver Bullet - Laser Welded	ST7-1
8" Silver Bullet - Laser Welded	ST8-1
10" Silver Bullet - Laser Welded	ST10-1



SUPREME LASER WELDED SEGMENTED BLADES

5" Supreme Laser Welded Segmented Blade - .250" Thick	TPXL5-7B
5" Supreme Laser Welded Segmented Blade .250" Thick (Soft Bond)	TPXLS5-7B
7" Supreme Laser Welded Segmented Blade - .250" Thick	TPXL7-7B
7" Supreme Laser Welded - Segmented Blade .250" Thick (Soft Bond)	TPXLS7-7B
Supreme Laser Welded - Segmented Blade .375" Thick	TPX7-2-7B
7" Supreme Laser Welded Segmented Blade - .500" Thick	TPX7-12-7B



PCD CLEAN OUT BLADES

4.5" 4-PCD Clean Out - .125" Thick	4.5PCD-4-2
7" 6-PCD Clean Out - .125" Thick	7PCD-6-2
7" 6-PCD Clean Out - .187" Thick	7PCD-6-7
8" 6-PCD Clean Out - .125" Thick	8PCD-6-2
8" 6-PCD Clean Out - .187" Thick	8PCD-6-7
10" 8-PCD Clean Out - .125" Thick	10PCD-8-2



CARBIDE CHUCK RESUE BLADES

4" Carbide Chunk Rescue Blades - .250" Thick	TRSC-4
--	---------------



CARBIDE CHUCK RESUE BLADES

7" Carbide Chunk Rescue Blades - .250" Thick	TRSC-7
--	---------------



V-SHAPED CRACK CHASER

4" V-Shaped Crack Chaser	CCS4-5Q
4" V-Shaped Crack Chaser (Threaded)	CCST4-5Q
5" V-Shaped Crack Chaser	CCS5-5Q
5" V-Shaped Crack Chaser (Threaded)	CCST5-5Q
7" V-Shaped Crack Chaser	CCS7-5Q
7" V-Shaped Crack Chaser (Threaded)	CCST7-5Q
8" V-Shaped Segmented Blade - 1" Arbor w/ Pin Hole - .375 Thick	CCS8-38-7B
8" V-Shaped Segmented Blade - 1" Arbor w/ Pin Hole - .500 Thick	CCS8-12-5Q



SQUARE-SHAPED SEGMENTED BLADES

8" Square-Shaped Segmented Blade - 1" Arbor w/ Pin Hole - .500 Thick	TPP8-12-7B
--	-------------------



MISCELLANEOUS ACCESSORIES



Adapter For Concrete Grinding **AGD-1**



Flush Cut Adapter **FCA-4**



HTC Shoe for Trap **HSHOE**



PROPRIETARY SHOE ADAPTERS

Lavina Shoe for Trap **LSHOE**



Pro Magnet For Universal Quick Change Plate **MAGNET**



Sasa Screw **SSCREW**



Adapter Screw **TRAPSCREW**



3" PLATE FOR STI® TO USE TRAPS

3" STI Trap Holder w/ Bolts **TRAPPLATESTI**

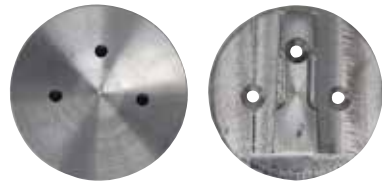

TERRCO® TRAP HOLDER W/ BOLTS

Terrco Trap Holder w/ Bolts **TRAPPLATETER**

1 Foot of Velcro - Hook Side **VELCRO**



VELCRO SPACERS

3" Velcro Spacer Pad - Hard Rubber **VP3**

3" Velcro Spacer Pad - Sponge **VPS3**



3" ROUND VELCRO PLATE FOR TRAP

Velcro backed for use of resins on universal plate system with trap cavity.

3" Velcro Plate for Resin ScanMaskin **VPLATESK**

3" Velcro Plate for Resin STI **VPLATESTI**

3" Velcro Plate for Resin Husky **VPLATEHUS**

3" Velcro Plate for Resin Terrco **VPLATETER**

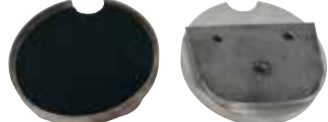

FLOOR MACHINE VELCRO HOLDERS WITH ATTACHMENTS FOR TRAY CAVITY

Velcro backed for use of resins on universal plate system with trap cavity.

3" Velcro Plate for Resin Lavina **VPLATEL**

3" Velcro for Resins **VPLATETRAP**



VELCRO PLATE FOR RESIN - NO LIP

Velcro Plate for Resins No Lip **VPLATE**



EXCHANGEABLE PLATE FOR RESINS FOR PLUG SYSTEM

Exchangeable Plate for Plug System **VPLUG**



TRAP VELCRO PLATE

Velcro backed for use of resin on trap systems.

Velcro Trap Plate **VTRAP**



- 3-inch caster wheels
- Balanced heavy-duty frame
- Adjustable seat with tool tray included

Rac-A-Tac - 3" Wheels w/ Chest Support **WDS01RAC3CS**



MOHS Hardness Test Kit **WDS-HD2**

WDS Longo Bags 14" Diameter **WDSMINIBAGS**

SDS MAX DEMO TOOLS

SDS MAX BITS:

201/2" Moil Point Chisel Internal Lock for Electric Hammer 11/8" Hex	WDS310
1 1/4" x 201/2" Narrow Chisel Internal Lock for Electric Hammer 11/8" Hex	WDS312
6" Blade Complete Scraper	WDS700
6" Scraper Blade Only - 2mm	WDS702H
6" Scraper Blade Only - 4mm	WDS702HD
Bushing Tool	WDS715
12" Bull Point Chisel	WDS710

18" Bull Point Chisel	WDS711
1" x 12" Flat Chisel	WDS712
1" x 18" Flat Chisel	WDS713
1" x 24" Flat Chisel	WDS713-24
2" x 12" Scaling Chisel	WDS707
2" x 18" Scaling Chisel	WDS707-18
2" x 24" Scaling Chisel	WDS707-24
3" x 12" Scaling Chisel	WDS714
3" x 18" Scaling Chisel	WDS714-18

WDS710 Bull Point Chisel

- Solid all purpose tool used for general concrete demolition
- Sharp four sided design on point end assures quick and easy penetration
- Shot peened for added strength and surface hardness
- Clear coated to further enhance product quality
- SDS-MAX shank



WDS711 Bull Point Chisel

- Very popular all purpose tool used for general concrete demolition
- Sharp four sided design on point end assures quick and easy penetration
- 18 in. overall dimension is ideal for applications requiring longer usable length
- Shot peened for added strength and surface hardness
- Clear coated to further enhance product quality
- SDS-MAX shank



WDS712 Flat Chisel

- Solid all purpose tool used for general concrete demolition
- Sharp blade design of chisel end assures quick and easy penetration and enhanced cutting angle
- Shot peened for added strength and surface hardness
- Clear coated for increased product quality
- SDS-MAX shank

WDS714 & WDS714-18 Scaling Chisel

- Quite popular concrete demolition tool utilized mainly for scaling applications
- 3 in. wide blade allows for efficient scaling in a variety of general demolition type work involving concrete, asphalt, and tile
- Shot peened for added strength and surface hardness
- Clear coated to further enhance product quality
- Available 12" and 18"
- SDS-MAX shank



WDS707 Scaling Chisel

- Very popular all purpose tool used for general concrete demolition
- 2 in. wide blade increases overall efficiency in all scaling applications
- Sharp blade design of chisel end assures quick and easy penetration and enhanced cutting angle
- Shot peened for added strength and surface hardness
- Clear coated for increased product quality
- SDS-MAX shank

WDS713 & WDS713-24 Flat Chisel

- Very popular all purpose tool used for general concrete demolition
- Sharp blade design of chisel end assures quick and easy penetration and enhanced cutting angle
- WDS713 = 18 in. WDS713-24 = 24in. overall dimension is ideal for applications requiring longer usable length
- Shot peened for added strength and surface hardness
- Clear coated to further enhance product quality
- SDS-MAX shank

SURFACE PREPARATION CHEMICALS



SUPER-HARD – MONO-SILICATE DENSIFIER CONCENTRATE

SUPER Hard Mono-silicate Densifier improves surface performance and resists the harmful effects of traffic wear and weathering. World Diamond Source SUPER Hard dust proofs, hardens, and cures the targeted surface in order to protect against dusting, pitting, spalling, and efflorescence that can be seen on untreated concrete.

FEATURES

- Ideal for new construction, existing concrete
- Odorless, non-flammable, non-toxic, VOC Compliant
- Helps reduce efflorescence and alkali silica reaction (ASR)
- Contains 30% Solids
- Coverage: 400-600 sqft per 1 gallon of mixed product. 1-gal. of concentrate makes 5 gals. of Densifier, 2000-3000 sqft of usable product.
- Penetrates deeply into concrete to densify and harden surfaces to help prevent entry of moisture and other foreign matter.
- Provides a permanent, attractive sheen with the ability to polish.
- Protects against scratching & peeling provides a protected surface.

SUPER-Hard (1 - Gallon - Concentrate - 4:1)	SHD-1
SUPER-Hard (5 - Gallon - Concentrate - 4:1)	SHD-5
SUPER-Hard (55 - Gallon - Concentrate - 4:1)	SHD-55
SUPER-Hard (250 - Gallon - Concentrate - 4:1)	SHD-250

Rejuvenating Cleaner 32oz. Bottle
(4 oz / 30 Gallons)
RJCON-1



SUPER-HARD FL – FLORIDA DENSIFIER

SUPER Hard FL is a multi-silicate blend, that is intended for use on extremely porous concrete. It sets up faster than other World Diamond Source densifiers, this keeps the majority of the SUPER Hard FL at the surface of the concrete in order to harden the wearable surface. Its ideal use is on open or porous concrete that will readily accept densifiers. When used in conjunction with World Diamond Source SUPER Shield 2 it is especially effective at resisting stains.

STORAGE

- Store upright in safe dry place at 40-105F° (4 -41C°)
- Keep product from freezing and Keep out of reach of children
- Seal container after use
- Do not mix with other chemicals

DILUTION & COVERAGE

SUPER Hard FL is a Ready to Use (RTU) product and should not be mixed with any other product. SUPER Hard FL has a coverage rate of 400-600 sq ft per gallon depending on porosity of concrete.

SUPER-Hard FL (1 - Gallon - Concentrate - 4:1)	SHDFL-1
SUPER-Hard FL (5 - Gallon - Concentrate - 4:1)	SHDFL-5
SUPER-Hard FL (55 - Gallon - Concentrate - 4:1)	SHDFL-55
SUPER-Hard FL (250 - Gallon - Concentrate - 4:1)	SHDFL-250

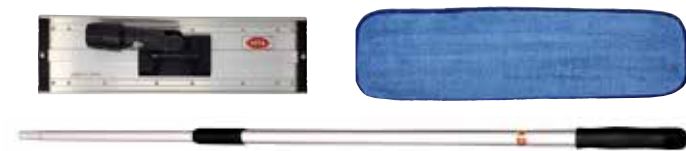

Micro Fiber Mop - 18" with Handle	MFM
Micro Fiber Pad - 18"	MFP
Micro Fiber Mop - 24" with Handle	MFM-24
Micro Fiber Pad - 24"	MFP-24

SURFACE PREPARATION CHEMICALS



SUPER-SHIELD 1 – PENETRATING RESISTOR

SUPER Shield 2 is a penetrating stain repellent specifically formulated to protect polished, dyed and non-dyed concrete from oil and water-based stains. The water and oil repelling qualities of SUPER Shield 2 provides superior stain protection on most substrates. SUPER Shield 2 can be used as a standalone product but, to obtain optimum performance, World Diamond Source SUPER Shield 2 is recommended for use with World Diamond Source densifiers.

FEATURES

- Non-topical, penetrating sealer
- VOC exempt & non-flammable
- Treated surfaces 'breathe' and do not trap moisture
- Excellent stain repellency for residential, commercial, and even industrial applications
- Extreme hydrophobic and oleophobic characteristics for maximum stain resistance
- Long-lasting protection with high coverage rate
- Safe for surfaces that experience high traffic
- Few instances of color change (slightly darkens concrete)
- Provides a chance to clean up spills before they stain or etch a surface

USES

- New or existing polished concrete, Exposed concrete flooring

DILUTION & COVERAGE

SUPER Shield 1 is shipped Ready to Use (RTU) and should not be mixed with any other chemical. Approximate coverage rate is 3,000 - 5,000 sqft per gallon.

SUPER-Shield 2 (1 - Gallon - RTU)	SSP-1
SUPER-Shield 2 (5 - Gallon - RTU)	SSP-5
SUPER-Shield 2 (55 - Gallon - RTU)	SSP-55
SUPER-Shield 2 (250 - Gallon - RTU)	SSP-250



SUPER-SHIELD 2 – SEMI-PENETRATING PROTECTOR

SUPER Shield 2 is a penetrating stain repellent specifically formulated to protect polished, dyed and non-dyed concrete from oil and water-based stains. The water and oil repelling qualities of SUPER Shield 2 provides superior stain protection on most substrates. SUPER Shield 2 can be used as a standalone product but, to obtain optimum performance, World Diamond Source SUPER Shield 2 is recommended for use with World Diamond Source densifiers.

FEATURES

- Extends stain-resistance
- Increases slip-resistance
- Increases surface hardness
- Enhances appearance and deepens color
- Improves gloss
- Clear, non-yellowing
- Can be burnished periodically to restore gloss
- Cures for foot traffic in 24 hours
- Simplifies maintenance
- Water-based

USES

- New or existing polished concrete, Exposed concrete flooring

DILUTION & COVERAGE

SUPER Shield 2 is shipped Ready to Use (RTU) and should not be mixed with any other chemical. Approximate coverage rate is 3,000 - 5,000 sqft per gallon.

SUPER-Shield 2 Stain Resistor (1 - Gallon - RTU)	SSR-1
SUPER-Shield 2 Stain Resistor (5 - Gallon - RTU)	SSR-5
SUPER-Shield 2 Stain Resistor (55 - Gallon - RTU)	SSR-55
SUPER-Shield 2 Stain Resistor (250 - Gallon - RTU)	SSR-250

AMERIPOLISH® COVERAGE RATE CHART

EZ ETCH	200 - 400 FT ² PER GALLON
OIL REMEDIATION	400 - 600 FT ² PER GALLON
STRIP & CLEAN	400 - 600 FT ² PER GALLON
PCA	1,200 - 1,500 FT ² PER GALLON
3D HS & HSL DENSIFIERS	600 - 800 FT ² PER GALLON
CLASSIC DYES	400 - 700 FT ² PER GALLON
SURELOCK DYES	400 - 700 FT ² PER GALLON
COLOR JUICE 3D	400 - 800 FT ² PER GALLON
EDGE TINT	800 - 1,000 LINEAR FEET PER GALLON
OS DYES	1,000 - 1,200 FT ² PER GALLON
3D SP STAIN PROTECTOR	2,000 - 2,500 FT ² PER GALLON
SR ² STAIN RESISTOR	3,000 - 5,000 FT ² PER GALLON
SR ² WB STAIN RESISTOR	2,000 - 3,000 FT ² PER GALLON
X-LINK WB & WL SURFACE SEALER	300 - 500 FT ² PER GALLON
DNS-400	250 - 300 FT ² PER GAL
POLISMART CS CLEANER	75,000 - 1,000,000 FT ² PER GALLON

*DISCLAIMER: THESE ARE ONLY AVERAGES, SO THE COVERAGE RATE CAN VARY DEPENDING ON THE FLOOR, IN ADDITION TO OTHER VARIABLES



AMERIPOLISH® CHEMICALS

Ameripolish® manufactures high performance architectural concrete products through extensive research and field testing. The Ameripolish product line includes innovative surface prep materials, overlamts, dyes, colorants, and maintenance treatments designed for the professional installer. Ameripolish uses cutting edge technology to prep, strengthen, color, protect and maintain polished concrete floors.

5 Gallon - 3D HS Florida Densifier (RTU)	2DPL-5
1 Gallon - 3D HS Densifier (RTU)	AP3DHP-1
5 Gallon - 3D HS Densifier (RTU)	AP3DHP-5
1 Gallon - SR2 Stain Resistor (RTU)	SR2-1
5 Gallon - SR2 Stain Resistor (RTU)	SR2-5
1 Gallon - 3DSP Semi Penetrating Stain Protector (RTU)	3DSP-1
5 Gallon - 3DSP Semi Penetrating Stain Protector (RTU)	3DSP-5
1 Gallon - SR2 Stain Resistor (RTU)	SR2-1
5 Gallon - SR2 Stain Resistor (RTU)	SR2-5
1 Gallon - Color Solve (RTU)	CS-1
5 Gallon - Color Solve (RTU)	CS-5

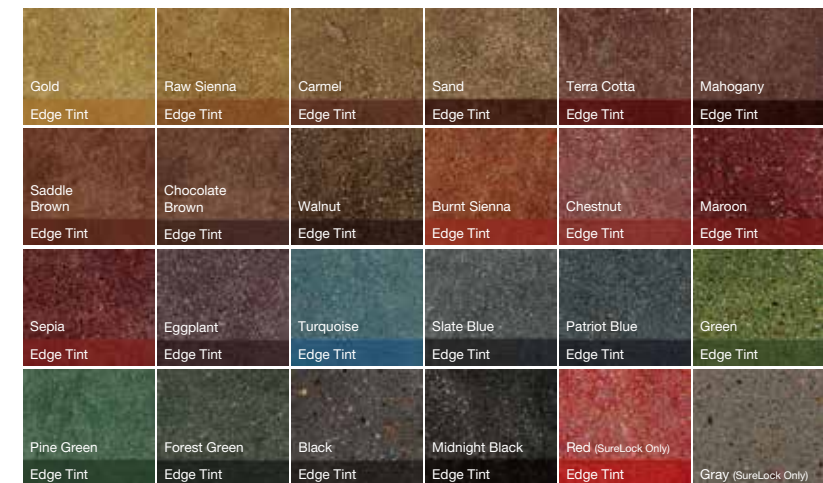

AMERIPOLISH® - Surelock® has recently had its formula updated making it the most vibrant concrete dye Ameripolish® has ever produced. It is a versatile colorant for polished concrete that mixes with water or acetone. SureLock can be used as a stand alone colorant product or can be combined with densifier. When mixed with 3D HS or HSL it penetrates and chemically bonds to the concrete. The pre-dissolved concentrate liquid is fast and very easy to use. The new formula includes UV stabilizers to resist fading as well as a penetrating agent to eliminate further mixing and develop deep, rich color even on hard, dense concrete.

1 Gallon SureLock Ameripolish Dye - Gold	SLA1	1 Gallon SureLock Ameripolish Dye - Chestnut	SLC2
5 Gallon SureLock Ameripolish Dye - Gold	SL5A1	1 Gallon SureLock Ameripolish Dye - Maroon	SLC3
1 Gallon SureLock Ameripolish Dye - Raw Sienna	SLA2	1 Gallon SureLock Ameripolish Dye - Sepia	SLC4
5 Gallon SureLock Ameripolish Dye - Raw Sienna	SL5A2	1 Gallon SureLock Ameripolish Dye - Eggplant	SLD1
1 Gallon SureLock Ameripolish Dye - Caramel	SLA3	1 Gallon SureLock Ameripolish Dye - Gray	SLD2
5 Gallon SureLock Ameripolish Dye - Caramel	SL5A3	5 Gallon SureLock Ameripolish Dye - Gray	SL5D2
1 Gallon SureLock Ameripolish Dye - Sand	SLA4	1 Gallon SureLock Ameripolish Dye - Black	SLD3
5 Gallon SureLock Ameripolish Dye - Sand	SL5A4	5 Gallon SureLock Ameripolish Dye - Black	SL5D3
1 Gallon SureLock Ameripolish Dye - Terra Cotta	SLB1	1 Gallon SureLock Ameripolish Dye - Midnight Black	SLD4
5 Gallon SureLock Ameripolish Dye - Terra Cotta	SL5B1	5 Gallon SureLock Ameripolish Dye - Midnight Black	SL5D4
1 Gallon SureLock Ameripolish Dye - Mahogany	SLB2	1 Gallon SureLock Ameripolish Dye - Patriot Blue	SLE1
5 Gallon SureLock Ameripolish Dye - Mahogany	SL5B2	1 Gallon SureLock Ameripolish Dye - Turquoise	SLE2
1 Gallon SureLock Ameripolish Dye - Saddle Brown	SLB3	1 Gallon SureLock Ameripolish Dye - Slate Blue	SLE3
5 Gallon SureLock Ameripolish Dye - Saddle Brown	SL5B3	1 Gallon SureLock Ameripolish Dye - Green	SLE4
1 Gallon SureLock Ameripolish Dye - Walnut	SLB4	1 Gallon SureLock Ameripolish Dye - Pine Green	SLF1
5 Gallon SureLock Ameripolish Dye - Walnut	SL5B4	1 Gallon SureLock Ameripolish Dye - Forest Green	SLF2
1 Gallon SureLock Ameripolish Dye - Burnt Sienna	SLC1	1 Gallon SureLock Ameripolish Dye - Chocolate Brown	SLF3
5 Gallon SureLock Ameripolish Dye - Burnt Sienna	SL5C1	5 Gallon SureLock Ameripolish Dye - Chocolate Brown	SL5F3
		1 Gallon SureLock Ameripolish Dye - Red	SLF4

THE DC STORM 600

The DC Storm 600 has a three-phase direct driven turbo pump that is suitable for continuous operation and heavy material transport, source extraction and cleaning. Several improvements have incorporated in it:

- A new efficient semi-automatic filter cleaning system.
- For easier transportation it has handles both front and rear and the cyclone can be tilted.
- For better ergonomic the handles are adjustable and the cyclone can be tilted for easier filter exchange.
- The new intellibag plastic bag system for dust free bag change.
- A new more efficient HEPA filter with a larger filter area.

Three basic models are available: bag (C), container (A) and Longopac (L) containers.

Specifications:

H x W x L (cm/inch):	74 x 38 x 38 / 29" x 15" x 15"
Weight kg/lbs:	194 x 78 x 116 mm 76" x 30" x 45"
Power consumption:	4 kW/ 10 HP/ 460V/ 60 Hz
Flow, max, open inlet	600 m ³ /h / 353 cfm
Max vacuum, inwg/kPa	132/33 kPa
Container	75 l/19 US gal
Filter area fine filter	5 m ²
Filter area HEPA filter	2.7 m ²
Sound level	75 dB(A)



ITEMS

DC STORM 600L vacuum 10hp. 230v takes Longo Pacs **WDS119435**

DC STORM 600LPG vacuum 10hp. Propane takes Longo Pacs **WDS119901**

DC STORM LPG Powered by Propane

Clean burning propane and the reliability of Dustcontrol[®] powered 21 HP engine. Designed for the user with class leading capacity and minimal maintenance requirements, the unit will operate approximately 8 hours on a full tank.

- External self-discharging cyclonic air filter with visual filter monitor.
- Available weight distributing chassis set available for early entry saw application.
- High efficiency, true cyclonic primary dust separation. Relieves filter loading, minimizes down-time and maximizes up-time.
- Effective reverse pulse cleaning on the main filter. Extends filter life.
- H13 HEPA filtration. Filters even the most dangerous respirable particulate and keeps your crew safe.
- Large pneumatic wheels, locking casters and an ergonomic handle.
- Integral chassis fork pockets for ease of loading and movement from place to place.
- Reliable belt drive and automatic mechanical clutch.
- Low maintenance 21HP motor with standard oil cooler and low oil pressure shut down.
- Three way catalytic muffler, O2 sensor, auto shut-down and alarm indication.
- Remote battery charger hook up point and LED battery monitor.
- 2 x 18 W LED Work Lamps for when you get into those out of the way places.
- 2 x USB outlets to keep your mobile devices charged.



Specifications:

H x W x L:	71" x 31" x 63" (with handle installed)
Engine:	21 HP
Flow, max. open inlet:	500 cfm
Vacuum, max.:	112 inwg
Tank Size:	33½ lbs
Weight:	570 lbs
Fine Filter Area:	55 ft ²
Filter Area HEPA H13:	29.4 ft ²

OTHER ITEMS AND ACCESSORIES

DCF8000L pre-separator for DC STORM 600L takes Longo Pacs **WDS70701**

Longo Pac Bags for DC 600L & DCF8000L (1-82' Pac) **WDS44077**

Pre-filter (polyester) for DC 600L vacuum **WDS44212**

Pre-filter (teflon coated) for DC 600L vacuum **WDS44081**

Hepa-filter for DC 600L and DC5900L vacuums **WDS42807**

DC 5900L vacuum 15hp. 460v **WDS119336**

DCF8000L pre-separator for DC 5900L takes Longo Pacs **WDS70701**

Longo Pac Bags for DC5900L & DCF8000L (1-82' Pac) **WDS44077**

Cyclone Lid Separator - Fits 55 Gallon Barrels **WDS7367**



DC1800C VACUUM

This machine is particularly suitable for general cleaning and source extraction from handheld power tools (with suction casings up to 125mm/5") and small table saws. The DC 1800 is equipped with a container. A plastic sack can be used inside the container to facilitate the emptying of dust and other material.



Specifications:

H x W x L (cm/inch):	74 x 38 x 38 / 29" x 15" x 15"
Weight:	10 kg/22 lbs
Hose Length:	5 m/16 ft 38 mm/1.5"
Container:	15 L/3.9 US gal
Flow at open inlet:	190 m ³ /h/114cfm
Negative pressure, max 115/230V:	21kPa/84 inwg
Power consumption 115/230V:	1340 W
Sound level:	1340 W

ITEMS

DC1800C vacuum	WDS101830
DC2900C vacuum	WDS120015
10pk. Bags for DC2900C vacuum	WDS42702

DC2900C VACUUM

The DC 2900 is our most popular dust extractor. It is suitable for vacuum cleaning and source extraction from handheld power tools (with suction casings up to 125mm/5") and small table saws. The DC 2900 has a sturdy steel chassis with large wheels, but is still light and portable.



Specifications:

H x W x L (cm/inch):	111 x 44 x 55 / 43" x 17" x 21"
Weight:	14 kg/30.8 lbs
Hose Length:	5 m/16 ft 38 mm/1.5"
Collector:	20 L/5.3 US gal
Flow at open inlet:	190 m ³ /h/114 cfm
Negative pressure, max 115/230V:	21 kPa/84 inwg
Power consumption 115/230V:	1340 W
Sound level:	68 dB(A)

Pre-filter for DC1800C and DC2900C vacuums	WDS42029
Hepa-filter for DC1800C and DC2900C vacuums	WDS42027
DC2800 pre-separator for DC1800C & DC2900C takes single bags	WDS7372

DC TROMB 400L WITH BAG

The DC Tromb 400 is designed to be supplied with (Part No.) Meet modern safety requirements and work in conjunction with tools that have become ever more efficient and that therefore produce more dust than they have previously. The maximum air flow is as high as 400 m³/h/ 247 cfm which is more than enough capacity for equipment such as floor grinders with a working width of 500 mm /19" and large electric cutoff saws. It is easy to transport around construction sites, move in stairwells and lift into tight spaces. The wheels are puncture-proof and won't leave marks on the floor. The front wheels are lockable to enable working on uneven ground.

Specifications:

H x W x L (cm/inch):	139 x 56 x 70 / 54" x 22" x 27"
Weight:	a/ 50 kg /110 lbs c/ 46 kg /101 lbs L/ 48 kg /106 lbs
Inlet:	76 mm /3"
Collector:	40 L/10 US gal /20 L/ 5 US gal longopac
Flow open inlet 115/230V:	360 m ³ /h / 212 cfm
Negative pressure, max 115/230V:	21/25 kPa /84/100 inwg
Power consumption 115/230V:	2100 W
Sound level:	70 dB(A)

DC AIRCUBE 2000

With a capacity of approximately 1,800 m³/h /1059 cfm the DC AirCube 2000 is the most powerful single-phase air cleaner on the market. The DC AirCube 2000 has a robust, stainless-steel chassis and an encapsulated fan with variable speed setting. With its ergonomic design, it is easy to carry and transport. It can also be operated when positioned horizontally. The DC AirCube 2000 has a HEPA H13 filter with an area totalling 10 m² /107ft². An integrated light indicates when it is time to replace the filter.



Specifications:

H x W x D (cm/inch):	102 x 56 x 70 / 40" x 22" x 27"
Weight:	30 kg /66lbs
Inlet/Outlet:	315/315 mm 12.4/12.4 inch
Power consumption, fan:	360/505 W
Flow at open inlet, max:	1800 m ³ /h /1059 cfm 276/353 cfm
Pre-filter area:	0.5 m ² /5.4 ft ²
Filter class:	H13
Sound level:	60-68 dB

ITEMS

DC TROMB 400L Vacuum Takes Longo Pac - - Takes Mini Bags	WDS161532
DC3900L Vacuum Pre-separator for Tromb 400 - Takes Mini Bags	WDS703900
Longo pac bags for DC TROMB 400L and DC3900L (4-60' pacs)	WDS432177
Pre-filter for DC TROMB 400L vacuum	WDS44017
Hepa-filter for DC TROMB 400L vacuum	WDS44016
DC Aircube 2000	WDSAC2000
DC Aircube 500	WDSAC500



DC AIRCUBE 500

The DC AirCube 500 has been developed for ease of use and durability. The fan unit is a radial blower with a specially designed scroll to build up high pressure across its entire flow range. This means that the unit generates a large amount of airflow during the entire lifetime of the filter. Equipped with a power socket for items such as a lamp. An exhaust hose can be used to create negative pressure in a sealed room. The fan has two speed settings, which means that the unit can be run economically, for example during the night.

Specifications:

H x W x D (cm/inch):	38 x 34 x 50 / 15" x 13" x 20"
Weight kg/lbs:	13 kg /28,6 lbs
Inlet/Outlet:	38 x 34 cm /Ø125 1.5 x 1.3 inch /5"
Power consumption, fan:	145/210 W
Flow at open inlet, max:	470/600 m ³ /h 276/353 cfm
Pre-filter area:	0,18 m ² /1.9 ft ²
Filter class:	H13
Sound level:	45-65 dB

TROMB

New DC Tromb

Meet Dustcontrol's expanded Tromb range. Efficient, powerful and dependable. Modular, ergonomic and flexible!

DC Tromb Twin

- A more robust design.
- Filter cleaning indication lamp.
- The twin-model is easy to separate and re-assemble.
- Handles concrete dust and other materials with the highest efficiency.

DC Tromb Twin	
Collection Dust Extractor: C) Bag. Collection Pre-Separator: C) Bag or L) Longopac.	
Technical data	
H x W x D [cm/inch]	138x60x128/54x24x31
Weight [kg/lbs]	CC) 71/156 CL) 75/165
Inlet Ø [mm/inch]	76/3
Collection container [l/gal]	C) 20/5.3 L) Longopac
Flow at open inlet 115/230V [m ³ /h/cfm]	330/ 365 & 215/ 194
Max flow- 115/230V [m ³ /h/cfm]	360/ 420 & 247/ 212
Negative pressure, max 115/230V [kPa/inwg]	20/20 /84/100
Power consumption 115/230V [W]	2100/2680/3000
Sound level [dB(A)]	70

Quality, Containment & Performance

DC Tromb 600 1-phase

Supplied with (Part No)

- Connecting sleeve (2129)
- Coupling socket (2008)
- Suction hose antistatic (Ø50 mm /2") 5 m/16 ft (2013)
- Floor nozzle B500 mm /W 19.7" (7238)
- Suction pipe (Ø50 mm /2") (7265)
- Fine filter, polyester (44017)
- HEPA H13 filter (44016)

Technical Data

HxWxD [mm/in]	1570x600x780 /62x24x31
Weight [kg/lb]	62/137
Collection container [l/gal]	L) Longopac
Flow max, fan, EU/US [m ³ /h/cfm]	600/353
Negative pressure, max, EU/US [kPa/inwg]	28/113
Power 230V /50Hz /60Hz [W]	4050



metabo

PROFESSIONAL POWER TOOL SOLUTIONS

metabo

PROFESSIONAL POWER TOOL SOLUTIONS

1400 WATT ALL-PURPOSE VACUUM CLEANER ASR 35

PART # 602057800

For extraction from the power tool in continuous mode, both on construction sites and in the workshop. Especially suited for extracting concrete and rock dust.

- Compact vacuum cleaner for liquids and dry solids with commercial registration
- Power socket for a power tool for using the automatic start-up/shut-down of the vacuum cleaner
- AutoCleanPlus: saves both costs and time thanks to automatic
- MPulse filter cleaning during continuous use
- If the optimum suction performance falls below a certain level, the filters are vibrated immediately
- Equipped with HEPA filter, keeps back 99.995% of fine dusts over 0.3 µ
- Automatic shut-down when vacuuming liquids once the maximum fill level is reached
- Suction power control for adapted suction performance
- Automatic trailing mechanism for emptying the suction hose completely
- Antistatic basic equipment prevents static charge when using appropriate accessories
- Sturdy thanks to especially large wheels and castors with wheel stop
- Cable winding mechanism. Practical accessory case and storage area
- Current Control: maximizes the suction power while the machine is connected so that the main fuse is not triggered



Specifications:

Air output max.: 4.380 cfm
Vacuum: 248 hPa (mbar)
Filter surface: 8.600 cm²
Input power max.: 1.400 W
Container volume: 35 l
Suction hose Ø: 35 mm
Hose length: 3.2 m
Weight: 16 kg
Cable length: 8 m

4 1/2" - GRINDER - SINGLE SPEED WP 1100-125

PART # 603612420

Description:

- Robust, universal and economical: ergonomic angle grinder for any application
- Powerful motor with good overload capacity
- Tool-free adjustable guard; twist-proof
- Paddle switch with dead man function: safe to operate due to an ergonomically integrated switch
- Suitable for 120 Volt direct current (DC)
- Grinding wheel Ø 115 / 125 mm
- Rated input power 1.100 W
- Output power 700 W
- No-load speed 12.000 rpm
- Revolutions at rated load 7.000 rpm
- Torque 2,6 Nm
- Spindle thread 5/8" - 11 UNC
- Weight (without power cable) 2,2 kg
- Cable length 2,5 m



2X HEPA FILTER CASSETTES FOR ASR35 ACP

PART # 630326000

Includes:

- 1x 2pk Metabo 630326000 HEPA Filter Cassettes for ASR35 ACP

Highlights:

- HEPA = high efficiency particulate air filter
- Stops 99.995% of fine dusts over 0,3 µm
- Corresponds to dust class H (HEPA 14)
- Keep your Metabo ASR 35 ACP running at peak performance with these genuine HEPA filter replacements. Sold in a pack of 2.



COLLECTION BAGS (5/PACK) 9/14 GAL, 35/50L

PART # 630325000

Description:

- Plastic Disposal Bags 5-pk
- Polyethylene disposal bags for use with 602057420 (ASR 35 ACP) and US602057800 (ASR 35 ACP HEPA). Plastic disposal bags cannot become blocked with fine dust (quartz dust in particular) like paper filter bags.
- Dimensions L x W x H: 15.5 x 11.5 x 3.5 inches

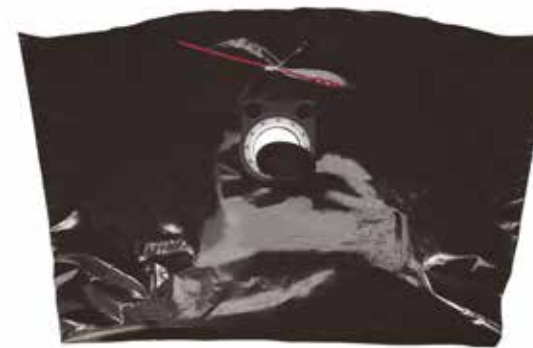

5" VARIABLE SPEED ANGLE GRINDER - WEV 15-125 HT

PART # 600562420

Description:

Optimum processing of stone: robust, powerful angle grinder with gear reduction and reduced, adjustable speed for material-friendly working. Longer service life, more power: the Metabo Long-life-motor with patented dust protection, up to 20% more overload capacity and 50% more torque.

- Grinding wheel Ø: 125 mm
- Rated input power: 1.550 W
- Output power: 900 W
- No-load speed: 2.800 - 9.600 rpm
- Revolutions at rated load: 9.600 rpm
- Torque: 4.2 Nm
- Spindle thread: 5/8" - 11 UNC
- Weight (without power cable): 2.5 kg
- Cable length: 2.5 m



Scope of delivery:

Guard, Inner support flange, Nut with two holes, Quick-locking nut, Side handle

5" CONCRETE GRINDER KIT W/ CARRY CASE & DUST CONTROL SHROUD - RSEV 19-125 RT

PART # 603825750

Description:

For effective spot grinding and removal of concrete, screed and coatings with diamond cup wheels. Maximum productivity thanks to 1,900 Watt strong Metabo Marathon-motor with low weight. High torque and overload capacity for demanding applications in continuous use. Low weight, ideal for sanding walls and ceilings. Working close to edges thanks to integrated folding segment.

Optimum extraction results: spring-mounted brush rim at the protective cover that adapts to any surface and segment height.

Front handle for safe and uniform guidance when polishing, adjustable without tools

Vario Tacho Constamatic (VTC) Full-wave Electronics with Thumbwheel: for working at customized speeds to suit the application material and speeds that remain almost constant, even under load. Electronic soft start for smooth start-up

Metabo S-automatic safety clutch: mechanical decoupling of the drive for safe working should the tool stop unexpectedly

Restart protection: prevents unintentional start-up after power supply interruption

Connection for dust extraction: Ø 35/41 mm

- Grinding wheel: Ø 125 mm
- Torque: 5 Nm
- No-load speed: 3.800 - 8.200 rpm
- Rated input power: 1.900 W
- Output power: 1.240 W
- Revolutions at rated load: 6.800 rpm
- Spindle thread: 5/8" - 11 UNC
- Weight (without power cable) 3.5 kg
- Cable length: 2.5 m



Scope of delivery:

Bow-type handle, Inner support flange, Nut with two holes, Replacement Brush Rim, Suction Adapter, Flat-pin spanners, Plastic carry case

9" ANGLE GRINDER, 2,400 WATT - W 24-230 MVT

PART # 606467420

Description:

Metabo Long-life motor with patented dust protection for long service life. Rotating back handle and side handle can be mounted at 3 positions for optimum handle position also when cutting.

Tool-free adjustable guard; twist-proof

Metabo VibraTech (MVT): integrated damping system and side handle to reduce vibrations in order to protect the user's health. Metabo safety switch prevents unintentional start.

Auto-stop carbon brushes to protect the motor

- Grinding wheel: Ø 230 mm
- No-load speed: 6.600 rpm
- Revolutions at rated load: 4.600 rpm
- Torque: 17 Nm
- Spindle thread: 5/8" - 11 UNC
- Weight (without power cable): 5,8 kg
- Cable length: 4 m

Scope of delivery:

Guard, Metabo VibraTech (MVT) side handle



9" ANGLE GRINDER, 2,400 WATT - KIT W/ DUST CONTROL SHROUD - W 24-230 K

PART # 60646780

Description:

Metabo Long-life motor with patented dust protection for long service life. Rotating back handle and side handle can be mounted at 3 positions for optimum handle position also when cutting.

Tool-free adjustable guard; twist-proof

Metabo VibraTech (MVT): integrated damping system and side handle to reduce vibrations in order to protect the user's health. Metabo safety switch prevents unintentional start.

Auto-stop carbon brushes to protect the motor

- Grinding wheel: Ø 230 mm
- No-load speed: 6.600 rpm
- Revolutions at rated load: 4.600 rpm
- Torque: 17 Nm
- Spindle thread: 5/8" - 11 UNC
- Weight (without power cable): 5,8 kg
- Cable length: 4 m

Scope of delivery:

Guard, Metabo VibraTech (MVT) side handle



5" HANDHELD SCARIFIER W/ CARRY CASE - RFEV 19-125 RT

PART # 603826760

For effective removal of plaster, adhesive residues, soft screed and old paint from walls, ceilings and floors
 Maximum productivity thanks to top 1,900 Watt with low weight
 Double reduction high-performance gearing for maximum torque and high output
 Fast work progress thanks to large milling diameter
 Perfect ergonomics thanks to slim handle for maximum control and easy working overhead
 Cutting depth can be adjusted easily and without the need for tools
 Robust protective cover made from die-cast aluminium with spring-mounted brush rim for low-dust working
 Front handle for safe and uniform guidance when milling, adjustable without tools
 Can be used as renovation grinder on smaller areas when using a diamond cup wheel
 Vario Tacho Constamatic (VTC) Full-wave Electronics with
 Thumb wheel: for working at customized speeds to suit the application material and speeds that remain almost constant, even under load
 Electronic soft start for smooth start-up
 Restart protection: prevents unintentional start-up after power supply interruption
 Connection for dust extraction Ø 35/41 mm

- Max. single blow energy (EPTA): 8,7 J
- Maximum impact rate: 2.900 bpm
- Rated input power: 1.150 W
- Bit retainer: SDS-max
- Weight (without power cable): 17,4 lbs
- Cable length: 6 m



Scope of delivery:
 Bow-type handle, Milling head pointed, Replacement Brush Rim, Suction Adapter, Flat-pin spanners, Hexagonal wrench, Plastic carry case

1100 WATT ELECTRONIC WET POLISHER - PWE 11-100

PART # 602050420

Polisher for wet processing of granite, marble and other high quality types of rock. Metabo® Long-life motor with patented dust protection for long service life
 Vario-Tacho-Constamatic (VTC)-Full Wave Electronics with Thumb wheel: for working at customized speeds to suit the application material and speeds that remain almost constant, even under load
 Adjustable, external water supply for exact metering. Housing cap for protection from splashes.
 Adjustable front handle for safe and uniform guidance when polishing
 PRCD safety switch integrated in the mains cable. Electronic overload protection for long service life
 Electronic soft start for smooth start-up. Restart protection: prevents unintentional start-up after power supply interruption.
 Auto-stop carbon brushes to protect the motor

- For backing pad up to maximum: 125 mm
- Rated input power: 1.100 W
- Output power: 630 W
- No-load speed: 1.700 - 6.100 rpm
- Revolutions at rated load: 6.100 rpm
- Torque: 2,6 Nm
- Spindle thread: 5/8" - 11 UNC
- Weight (without power cable): 2.2 kg
- Cable length: 4 m



Scope of delivery:
 Bow-type handle, Front protective cap, PRCD safety switch, (Delivery without backing pad and buffing wheel)

SDS-MAX CHIPPING HAMMER W/ CARRY CASE - MHEV 5 BL

PART # 600769620

High breaking performance thanks to maintenance-free brushless motor and high-performance hammer action
 Long service life thanks to brushless technology and robust aluminum die-cast housings of gear and motor
 Metabo Vibra-Tech (MVT) with double dampening: Decoupled handle and impact-absorbing counter-oscillating weight actively reduce vibrations for healthy working also in continuous use.
 Ergonomically shaped, slim gripping area with large speed control trigger for comfortable working
 Easily accessible locking switch for chiselling in continuous mode
 Vario-Tacho-Constamatic (VTC)-Full Wave Electronics for work with materials requiring customized speeds, which remain constant under load
 Optional reduction of the impact energy for working in softer materials
 Electronic soft start for smooth start-up
 Restart protection: prevents unintentional start-up after power supply interruption
 Low-dust chiseling with external dust extraction ESA max (accessories)
 Overload protection: protects the motor from overheating
 The adjustable front handle can be rotated 360° and the angle adjusted for an optimum working position

- Max. single blow energy (EPTA): 8,7 J
- Maximum impact rate: 2.900 bpm
- Rated input power: 1.150 W
- Bit retainer: SDS-max
- Weight (without power cable): 17,4 lbs
- Cable length: 6 m



Scope of delivery:
 Side handle, Front handle, Lubricant for tool shank end, Duster, Plastic carry case

SDS-MAX CHIPPING HAMMER W/ CARRY CASE - MHEV 11 BL

PART # 600770620

High breaking performance thanks to maintenance-free brushless motor and high-performance hammer action
 Long service life thanks to brushless technology and robust aluminum die-cast housings of gear and motor
 Metabo Vibra-Tech (MVT) with double dampening: Decoupled handle and impact-absorbing counter-oscillating weight actively reduce vibrations for healthy working also in continuous use.
 Ergonomically shaped, slim gripping area with large speed control trigger for comfortable working
 Easily accessible locking switch for chiseling in continuous mode
 Optional reduction of the impact energy for working in softer materials
 Vario-Tacho-Constamatic (VTC)-Full Wave Electronics for work with materials requiring customized speeds
 The adjustable front handle can be rotated 360° and the angle adjusted for an optimum working position
 Electronic soft start for smooth start-up
 Restart protection: prevents unintentional start-up after power supply interruption
 Overload protection: protects the motor from overheating
 Low-dust chiseling with external dust extraction ESA max (accessories)

- Max. single blow energy (EPTA): 18 J
- Maximum impact rate: 2.100 bpm
- Rated input power: 1.500 W
- Bit retainer: SDS-max
- Weight (without power cable): 26.9 / 27 lbs
- Cable length: 6m



Scope of delivery:
 Rubber-coated side handle, Drilling depth guide, Lubricant for tool shank end, Duster, Plastic carry case

SDS-MAX COMBINATION HAMMER / ROTATE WITH CARRY CASE - KHEV 5-40 BL

NEW

PART # 600765620

Description:

Maximum drilling progress and high breaking performance thanks to maintenance-free brushless motor and high-performance hammer action

Long service life thanks to brushless technology and robust aluminum die-cast housings of gear and motor

Combination hammer with 2 functions: hammer drilling and chiseling

Metabo VibraTech (MVT) with double dampening: Decoupled handle and impact-absorbing counter-oscillating weight actively reduce vibrations for healthy working also in continuous use.

Ergonomically shaped, slim gripping area with large speed control trigger for comfortable working

Easily accessible locking switch for chiseling in continuous mode

Vario-Tacho Constamatic (VTC)-Full Wave Electronics for work with materials requiring customized speeds, which remain constant under load

Optional reduction of speed and impact energy for working in softer materials

Electronic soft start for precise spot-drilling

Metabo S-automatic safety clutch: mechanical decoupling of the drive for safe working should the drill stop unexpectedly

Restart protection: prevents unintentional start-up after power supply interruption

Overload protection: protects the motor from overheating

Low-dust chiseling and drilling with external dust extraction ESA max (accessories)

- Max. single blow energy (EPTA): 8,7 J
- Maximum impact rate: 2.900 bpm
- Rated input power: 1.100 W
- Drill-Ø concrete with hammer drills: 40 mm
- Drill-Ø masonry with core bits: 105 mm
- No-load speed: 350 / 500 rpm
- Revolutions at rated load: 350 / 500 rpm
- Bit retainer: SDS-max
- Collar diameter: 64.6 mm
- Weight (without power cable): 18.3 lbs
- Cable length: 6 m

Scope of delivery:

Rubber-coated side handle,
Drilling depth guide,
Lubricant for tool shank end,
Duster, Plastic carry case



ELECTRONIC COMBINATION HAMMER W/ CARRY CASE - KHE D-26

NEW

PART # 601109420

Description:

Combination hammer with 3 functions: hammer drilling, drilling and chiseling

Spade grip handle for greatest work comfort and maximum productivity when working above the head or facing downwards

Vario (V)-Electronics for working at customized speeds to suit various application materials

High performance hammer action, precisely mounted in a housing made of aluminum alloy: long-lasting and robust

Metabo S-automatic safety clutch: mechanical decoupling of the drive for safe working should the drill stop unexpectedly

Lockable switch for comfortable working in continuous operation

Scaffolding hook for easy and safe temporary storage of the hammer on scaffoldings and ladders

- Max. single blow energy (EPTA): 2,3 J
- Maximum impact rate: 5.400 bpm
- Rated input power: 800 W
- Drill-Ø concrete with hammer drills: 26 mm
- Drill-Ø masonry with core bits: 68 mm
- Drill Ø steel: 13 mm
- Drill-Ø soft wood: 30 mm
- No-load speed: 0 - 1.150 rpm
- Revolutions at rated load: 960 rpm
- Bit retainer: SDS-plus
- Collar diameter: 43 mm
- Weight (without power cable): 2,9 kg
- Cable length: 4 m

Scope of delivery:

Hammer chuck for tools with SDS-plus shank end, Side handle, Drilling depth guide, Plastic carry case



SDS MAX HAMMER / ROTATE DUST EXTRACTION KIT W/ CARRY CASE FOR VACUUM

PART # 623271000

- For extraction from the power tool in continuous mode. Especially suited for extracting concrete and rock dust
- For drilling and chiseling - with different drill attachments from Ø 16-52 mm, pointed and flat chisels up to 25 mm
- Installation without tools - drills and chisels can be exchanged without removing the extraction - External dust extraction
- Compatible with all new Metabo SDS-max hammers in conjunction with all Metabo M and H extraction sets
- The machine shown may differ in equipment and technical details depending on the configuration - Accessories included only if listed in the delivery scope



5" UNIVERSAL DUST SHROUD

PART # NEWSHROUD5

5" Rubber Collar Shroud - (Makita, Hitachi, Dewalt, Milwaukee, Bosch, Metabo)



7" UNIVERSAL DUST SHROUD

PART # NEWSHROUD7

7" Rubber Collar Shroud - (Makita, Hitachi Bosch)

5" CONVERTIBLE SHROUD

PART # 655153000

- Dustless convertible shroud for concrete surface prep.
- 5" shroud. For all current small angle grinders W 9 / W 12 / W 15 / W 17



7" CONVERTIBLE SHROUD

PART # 655154000

- Dustless convertible shroud for concrete surface prep.
- 655154000 7" shroud. For all current large angle grinders W 24 / W 26



10 CUTTING STARS, POINTED HEAD - RFEV 19-125 RT

PART # 628270000

Description:

- For retrofitting with RFEV 19-125 RT cutting head
- With 5 micro-encapsulated screws for secure attachment



HEX BOLTS FOR HANDLE

PART # 141110390



GRINDER OFF-SET SPANNER WRENCH

PART # 62391000



LOOP HANDLE FOR ALL LARGE GRINDERS

PART # 630342000



PERFECT TRAC

THE PERFECT TRAC SAW is the best tool on the market for the prepping and removal of joint fillers as well as controlled and decorative cuts. Newly redesigned, it has a maximum depth cut of 2¼" using a 7" blade. The Perfect Saw is easy to operate, portable and adjustable so anyone can tackle the job no matter how small or large. You will see cleaner cuts with little to no chipping and by attaching a vacuum you can work dust free. The Perfect Trac Saw runs on 110v / 20amp power supply at a low RPM allowing you to work anywhere and giving both your blades and interchangeable motor a longer life.

DESCRIPTION

Perfect Trac 7" Concrete Saw

Perfect Trac 7" Concrete Saw

WDS PART#

PT75SAW

PT10SAW

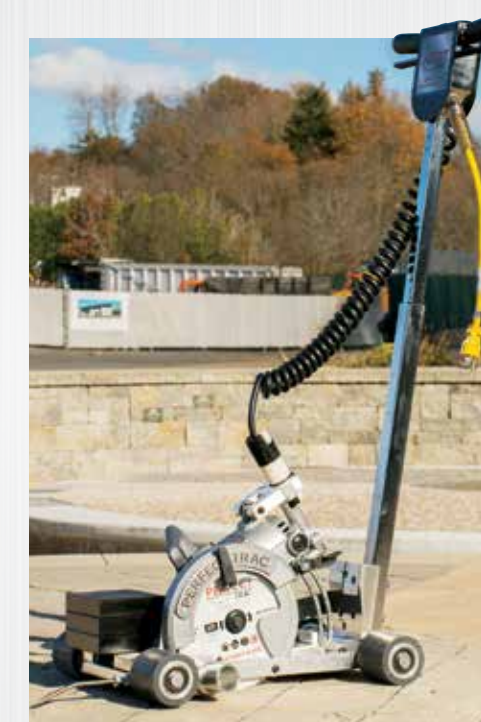
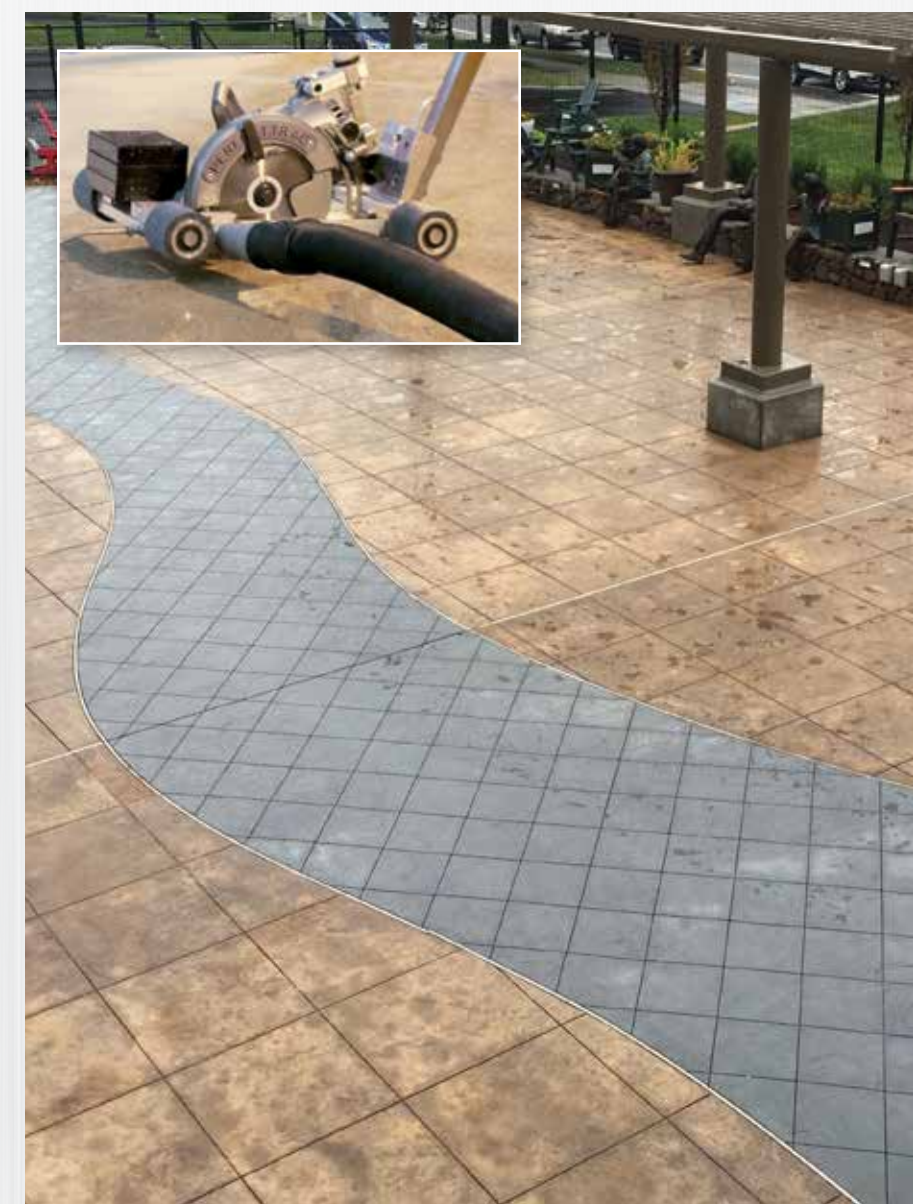

WALK-BEHIND BLADES

SECTION E

Our wet walk-behind blades are all custom-made to your specifications. Sizes from 12" to 72" are available in different bonds and grades. Other sizes and specs are available upon request. Most common bonds and specs are in stock.



DIAMOND WALK-BEHIND BLADES

Our wet walk-behind blades are all custom-made to your specifications. Sizes from 12" to 72" are available in different bonds and grades. Other sizes and specs are available upon request. Most common bonds and specs are in stock.



BLADE THICKNESS CODE INDEX	
1	0.110"
2	0.125"
3	0.142"/0.145"
4	0.155"
5	0.165"
6	0.175"
7	0.187"
14	0.197"
8	0.210"
9	0.220"
10	0.250"
13	0.312"
11	0.375"
12	0.500"

All with kicker segments for undercut protection.

800 SERIES PCU: .415" / .375
Usable Segment Height

900 SERIES PCXX: .575" / .490
Usable Segment Height
* 900 Series is same PRO Quality as our 800 Series with a taller segment for even more value on your cost per cut.

UNDERCUT PROTECTION
All WDS walk-behind saw blades have undercut protection for added life and increased safety.

CONCRETE BLADES - Drop Segments and/or Kicker Segment

OVERLAY BLADES - Drop Segments and/or Kicker Segment

ASPHALT BLADES - Undercut Protection On Every Segment!!!



BEVELED BLADES FOR CONCRETE

12" Bevel Blade with 10" Bevel	BV12-10-1
14" Bevel Blade with 10" Bevel	BV14-12-1



WDS bevel blades are used to cut a bevel angle when cutting joints. Creates a V-Cut. Each blade has a 45 degree angle, leaving a 90 degree bevel in the cut when used in a two blade stacked configuration. These blades are sold as a matched set of 3 blades. A center line blade, and 2- 45 degree angle blades.

CURED CONCRETE

800 - MAX PRO SERIES

10 SOFT BOND RED
20 MEDIUM BOND YELLOW

18"x.125"x.415"x1"wph	PCU18-810-2
18"x.125"x.415"x1"wph	PCU18-820-2
20"x.125"x.415"x1"wph	PCU20-810-2
20"x.125"x.415"x1"wph	PCU20-820-2
20"x.187"x.415"x1"wph	PCU20-810-7
24"x.155"x.415"x1"wph	PCU24-810-4
24"x.155"x.415"x1"wph	PCU24-820-4
24"x.187"x.415"x1"wph	PCU24-810-7
26"x.165"x.415"x1"wph	PCU26-810-5
26"x.165"x.415"x1"wph	PCU26-820-5
30"x.187"x.415"x1"wph	PCU30-810-7
30"x.187"x.415"x1"wph	PCU30-820-7
36"x.187"x.415"x1"wph	PCU32-810-7
36"x.187"x.415"x1"wph	PCU36-820-7

CURED CONCRETE BONDS

- 5 Super Soft Bond - Extreme Hard Aggregate with Heavy Steel Reinforcement
- 10 Soft Bond - Critically Hard Aggregate
- 20 Medium Bond - GP Medium Aggregate

900 - ULTRA SERIES

5 SUPER SOFT BOND ORANGE
10 SOFT BOND BLUE
20 MEDIUM BOND LIGHT GREY

18"x.125"x.575"x1"wph	PCXX18-910-2
18"x.125"x.575"x1"wph	PCXX18-920-2
20"x.125"x.575"x1"wph	PCXX20-905-2
20"x.155"x.575"x1"wph	PCXX20-905-4
20"x.187"x.575"x1"wph	PCXX20-905-7
20"x.125"x.575"x1"wph	PCXX20-910-2
20"x.155"x.575"x1"wph	PCXX20-910-4
20"x.187"x.575"x1"wph	PCXX20-910-7
20"x.125"x.575"x1"wph	PCXX20-920-2
24"x.155"x.575"x1"wph	PCXX24-905-4
24"x.125"x.575"x1"wph	PCXX24-910-2
24"x.155"x.575"x1"wph	PCXX24-910-4
24"x.155"x.575"x1"wph	PCXX24-920-4
26"x.165"x.575"x1"wph	PCXX26-905-5
26"x.187"x.575"x1"wph	PCXX26-905-7
26"x.187"x.575"x1"wph	PCXX26-910-7
26"x.187"x.575"x1"wph	PCXX26-920-7
30"x.165"x.575"x1"wph	PCXX30-905-5
30"x.187"x.575"x1"wph	PCXX30-905-7
30"x.187"x.575"x1"wph	PCXX30-910-7
30"x.187"x.575"x1"wph	PCXX30-920-7
32"x.187"x.575"x1"wph	PCXX32-910-7
36"x.165"x.575"x1"wph	PCXX36-905-5
36"x.187"x.575"x1"wph	PCXX36-905-7
36"x.187"x.575"x1"wph	PCXX36-910-7



DIAMOND WALK-BEHIND BLADES

DIAMOND WALK- BEHIND BLADES



ASPHALT/GREEN CONCRETE

600 SERIES

Size	Model
18" x .125"	PA18-690-2
20" x .125"	PA20-690-2
20" x .187"	PA20-690-7
24" x .155"	PA24-690-4
24" x .187"	PA24-690-7
26" x .187"	PA26-690-7
30" x .187"	PA30-690-7
36" x .187"	PA36-690-7

900 SERIES

Size	Model
14" x .125"	PA14-990-2
18" x .125"	PA18-990-2
20" x .125"	PA20-990-2
20" x .187"	PA20-990-7
24" x .155"	PA24-990-4
26" x .187"	PA26-690-7

All with 3 step kicker or slanted segments for undercut protection.
PA: .335" Segment Height

GRADE / SERIES

- 600 - SUPER PRO SERIES
- 800 - MAX PRO SERIES
- 900 - ULTRA SERIES



ASPHALT OVER CONCRETE

Size	Super Pro 550S
16" x .125"	PAC16-550S-2
18" x .125"	PAC18-550S-2
18" x .187"	PAC18-550S-7
18" x .250"	PAC18-550S-10
18" x .375"	PAC18-550S-11
20" x .125"	PAC20-550S-2
24" x .165"	PAC24-550S-5
26" x .165"	PAC26-550S-5
26" x .187"	PAC26-550S-7
30" x .165"	PAC30-550S-5
30" x .187"	PAC30-550S-7
36" x .187"	PAC36-550S-7

All with slant segments and kicker segments for undercut protection.
PAC: .350" Segment Height

GRADE / SERIES

- 600 - SUPER PRO SERIES
- 800 - MAX PRO SERIES
- 900 - ULTRA SERIES

BLADE THICKNESS CODE INDEX

1	0.110"
2	0.125"
3	0.142" / 0.145"
4	0.155"
5	0.165"
6	0.175"
7	0.187"
14	0.197"
8	0.210"
9	0.220"
10	0.250"
13	0.312"
11	0.375"
12	0.500"

HEAVY HIGHWAY GREEN CONCRETE

Size	Model
14" x .140" x .472 x 1"	PGCX14-3
14" x .140" x .472 x 1"	PGCXH14-3

LOOPING BLADES

Our looping blades can be used on all types of hand held and walk-behind saws. Their superior quality makes their cutting speed and life unmatched. They will exceed your expectations! Readily available in .187", .250", .312", .375" and .500" thicknesses. Other thicknesses are available by special order upon request.



ASPHALT LOOPING BLADE

Pro Series, Laser Welded, Dry/Wet, .380" Segment Height

12" x .250" x 1"	LAX12-10-1
12" x .312" x 1"	LAX12-13-1
12" x .375" x 1"	LAX12-11-1
14" x .187" x 1"	LAX14-7-1
14" x .250" x 1"	LAX14-10-1
14" x .312" x 1"	LAX14-13-1
14" x .375" x 1"	LAX14-11-1
14" x .500" x 1"	LAX14-12-1
16" x .500" x 1"	LAX16-12-1
18" x .250" x 1"	LAX18-10-1
18" x .375" x 1"	LAX18-11-1
18" x .500" x 1"	LAX18-12-1



CONCRETE LOOPING BLADES

Pro Series, Laser Welded, Dry/Wet, .380" Segment Height

12" x .250" x 1"	LCX12-10-1
12" x .375" x 1"	LCX12-11-1
14" x .187" x 1"	LCX14-7-1
14" x .250" x 1"	LCX14-10-1
14" x .312" x 1"	LCX14-13-1
14" x .375" x 1"	LCX14-11-1
14" x .500" x 1"	LCX14-12-1
18" x .250" x 1"	LCX18-10-1
18" x .375" x 1"	LCX18-11-1
18" x .500" x 1"	LCX18-12-1

PREMIUM SERIES

14" x .250" x 1"	LC14-10-1
------------------	-----------

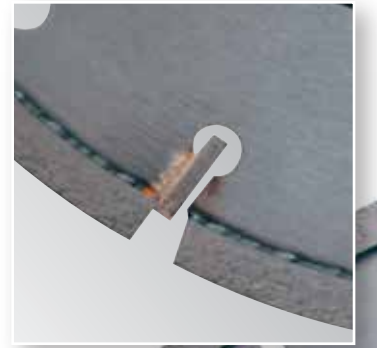

DIAMOND WALK- BEHIND BLADES

DIAMOND WALL SAW BLADES



CUSTOM MADE WALL SAW BLADES

CALL: 800-611-8278

All standard wall saw cores are machined to fit the 360 flush cut flanges. Additional arbor sizes and flush cut patterns available upon request.

Sizes	30" x .220"	42" x .187"
18" x .187"	30" x .250"	42" x .220"
18" x .220"	32" x .187"	42" x .250"
18" x .250"	32" x .220"	48" x .187"
24" x .187"	32" x .250"	48" x .220"
24" x .220"	36" x .187"	48" x .250"
24" x .250"	36" x .220"	54" x .220"
26" x .187"	36" x .250"	54" x .250"
26" x .220"	40" x .187"	60" x .220"
26" x .250"	40" x .220"	60" x .250"
30" x .187"	40" x .250"	

NARROW NOTCH BONDS:

1 Very Hard

Non-abrasive hard concrete, general purpose, air saws, fast cutting, hydraulic saws

3 Hard-Hard to Medium

Hard reinforced concrete, longer life, air saws, hydraulic saws

5 Medium

Concrete with dense limestone aggregate, hydraulic saws

WIDE NOTCH BONDS:

10 Very Hard:

Non-abrasive hard concrete, general purpose, air saws, fast cutting, hydraulic saws

20 Hard-Hard to Medium:

Hard reinforced concrete, longer life, air saws, hydraulic saws

30 Medium:

Concrete with dense limestone aggregate, hydraulic saws

WDS SUPER WALL SAW BLADES

V-NOTCH SEGMENT

24" x .187"	WSV24-7-1
26" x .187"	WSV26-7-1
30" x .187"	WSV30-7-1
32" x .187"	WSV32-7-1
32" x .250"	WSV32-10-1
36" x .187"	WSV36-7-1
42" x .187"	WSV42-7-1
42" x .220"	WSV42-9-1
42" x .250"	WSV42-10-1
44" x .187"	WSV44-7-1
48" x .187"	WSV48-7-1
48" x .220"	WSV48-9-1
48" x .250"	WSV48-10-1
54" x .187"	WSV54-7-1
54" x .220"	WSV54-9-1
54" x .250"	WSV54-10-1
60" x .187"	WSV60-7-1
72" x .220"	WSV72-9-1

SPLIT SEGMENT - PRO WALL SAW BLADES

24" x .187"	WSS24-7-1
24" x .220"	WSS24-9-1
26" x .187"	WSS26-7-1
26" x .220"	WSS26-9-1
30" x .220"	WSS30-9-1
36" x .187"	WSS36-7-1
36" x .220"	WSS36-9-1

WE STOCK
All Sizes 24"-72"
Ready for immediate same day shipping
all across the country!



DIAMOND HYDRAULIC HAND SAW BLADES

THE RIPPER®

The Ripper® Blade is the Pro Cutters Choice by name. Whether its speed or life you are looking for this blade will deliver on every cut. The Ripper® Blade out performs every hand saw blade on the market today. Bar None!

Pre-dressed segments, cuts super fast right out of the box, 12mm tall notched segments for extended life, sandwich bonded segments for maximum performance, cuts 20% faster with excellent life available in 16", 20 5/8", 24" and 30" 6-bolt hole pattern w/ drive pin hole.

SUPER PRO RIPPER - SEGMENTED HAND HELD SAW BLADE

SPECIAL MATRIX BOND - LONG LIFE COLOR: AQUA GREEN

16" x .125"	HHWS16-DS
20 5/8" x .140"	HHWS20-DS
24" x .140"	HHWS24-DS
30" x .155"	HHWS30-DS

ORIGINAL FORMULA - MEDIUM BOND COLOR - BLACK

16" x .125"	HHSSWS16-DS
20 5/8" x .140"	HHSSWS20-DS
20" 5/8" x .140" (W-Seg)	HHWS10-20
24" x .140"	HHSSWS24-DS
24" 5/8" x .140" (W-Seg)	HHWS10-24
30" x .155"	HHSSWS30-DS

COPPER BOND - EXTREME SOFT COLOR - ORANGE

16" x .125"	HHXS16-DS
20 5/8" x .140"	HHXS20-DS
20" 5/8" x .140" (W-Seg)	HHWS5-20
24" x .140"	HHXS24-DS
24" 5/8" x .140" (W-Seg)	HHWS5-24
30" x .155"	HHXS30-DS



HIGH-SPEED DIAMOND BLADES

HAND HELD, MASONRY SAWS
& LOW H.P WALK BEHINDS

SECTION G

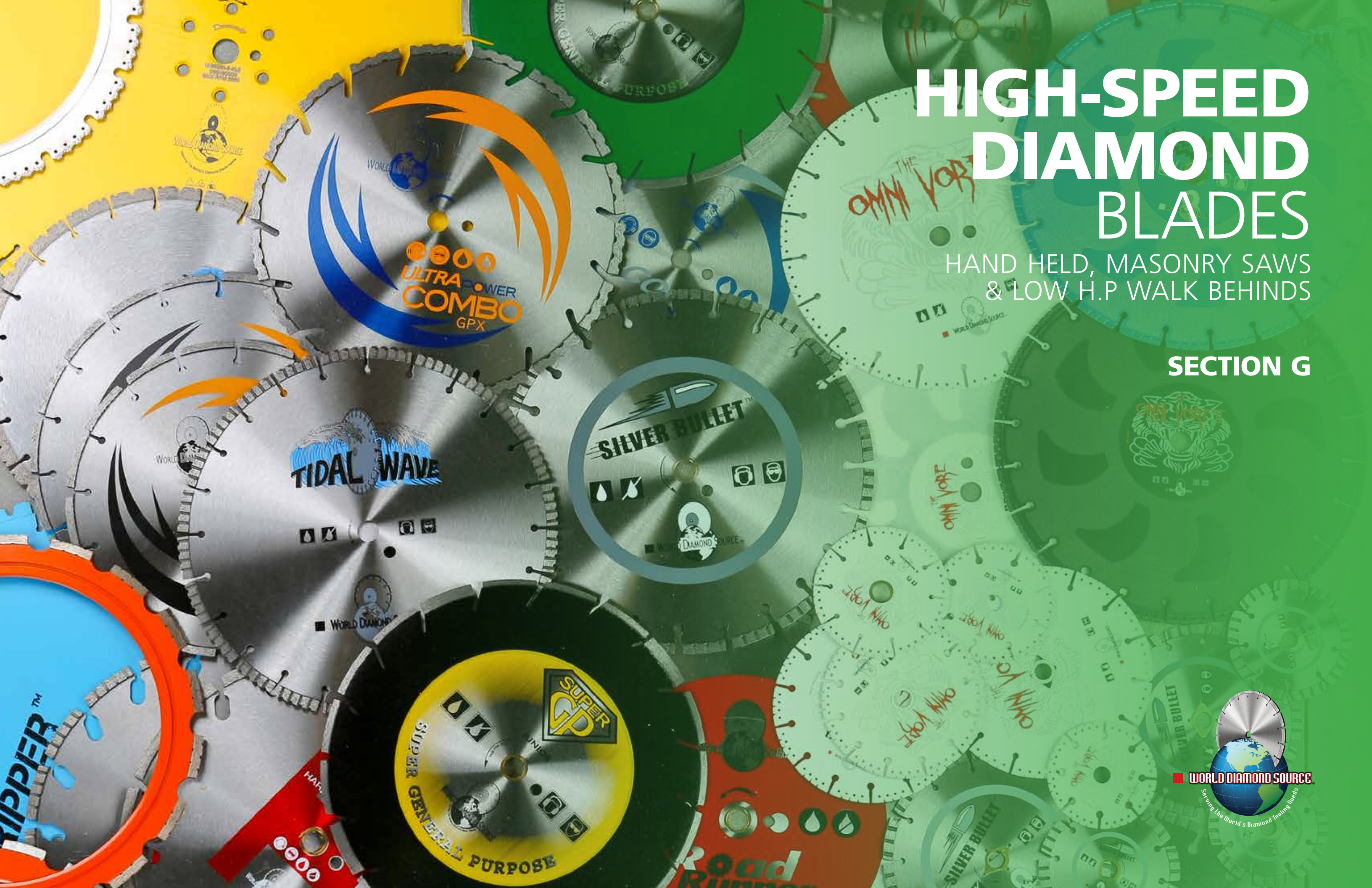

HIGH SPEED DIAMOND BLADES

HAND HELD,
MASONRY SAWS &
LOW H.P WALK
BEHINDS

*Our high speed segmented blades are available in
12",14", 16", 18" and 20".*

*These blades come in different bonds depending
on the aggregate or material being cut.
Quality varies from economy to ultra supreme pro.*

HIGH SPEED DIAMOND BLADES

HAND HELD,
MASONRY SAWS &
LOW H.P WALK
BEHINDS

CURED CONCRETE



COOL CUT™
Cured Concrete, Premium, Laser Welded,
Dry/Wet, .300" Segment Height

12" x .110" x 1"	DC12-1
12" x .110" - 20mm	DC12-1/20
14" x .110" x 1"	DC14-1
14" x .110" - 20mm	DC14-1/20
16" x .125" x 1"	DC16-1
18" x .125" x 1"	DC18-1
20" x .125" x 1"	DC20-1



COOL CUT™
Cured Concrete, Ultra Supreme™, Laser
Welded, Dry/Wet, .380" Segment Height

14" x .125" x 1"	DCUX14-1
16" x .125" x 1"	DCUX16-1



POWER COMBO® GP
Premium, General Purpose, Laser Welded,
Dry/Wet, .300" Segment Height

12" x .125" x 1"	GP12-1
12" x .125" x 20mm	GP12-1/20
14" x .125" x 1"	GP14-1
14" x .125" x 20mm	GP14-1/20
16" x .125" x 1"	GP16-1



POWER COMBO® GPS
Premium, General Purpose, Laser Welded,
Dry/Wet, Soft Bond, .300" Segment Height

12" x .125" x 1"	GPS12-1
12" x .125" x 20mm	GPS12-1/20
14" x .125" x 1"	GPS14-1
14" x .125" x 20mm	GPS14-1/20

CURED CONCRETE



SUPER GP® SERIES
General Purpose, Laser Welded, Dry/Wet,
.320" Segment Height

12" X .125" X 1"	SGP12-1
12" X .125" X 20mm	SGP12-1/20
14" x .125" x 1"	SGP14-1
14" x .125" x 20mm	SGP14-1/20
16" x .125" x 1"	SGP16-1
18" x .125" x 1"	SGP18-1



**CARNIVORE®
NICECUT PRO SERIES LASER**
Welded .320" Segment Height

12" X .125" X 1"	CNC12-1
12" X .125" X 20mm	CNC12-1/20
14" x .125" x 1"	CNC14-1
14" x .125" x 20mm	CNC14-1/20
16" x .125" x 1"	CNC16-1

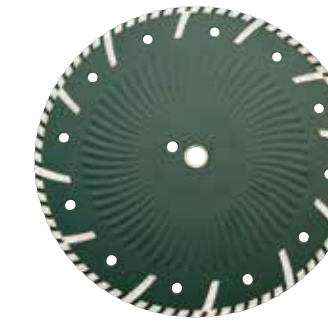

SUPER TURBO
General Purpose, Dry/Wet

12" x .125" x 1"	STGP12-H
14" x .125" x 1"	STGP14-H

ASPHALT & GREEN CONCRETE



**ROAD RUNNER®
ASPHALT & GREEN CONCRETE**
Heavy-Duty, Laser Welded, Dry/Wet,
.300" Segment Height

12" x .125" x 1"	DAG12-1
12" x .125" x 20mm	DAG12-1/20
14" x .125" x 1"	DAG14-1
14" x .125" x 20mm	DAG14-1/20
16" x .125" x 1"	DAG16-1
18" x .125" x 1"	DAG18-1



**ROAD RUNNER®
ASPHALT & GREEN CONCRETE**
Premium, Laser Welded, Dry/Wet,
.320" Segment Height

12" x .125" x 1"	DAGP12-1
12" x .125" x 20mm	DAGP12-1/20
14" x .125" x 1"	DAGP14-1
14" x .125" x 20mm	DAGP14-1/20
16" x .125" x 1"	DAGP16-1



**ROAD RUNNER®
ASPHALT & GREEN CONCRETE**
Ultra Supreme, Laser Welded, Dry/Wet,
.380" Segment Height

14" x .125" x 1"	DAGX14-1
------------------	-----------------

HIGH SPEED DIAMOND BLADES

HAND HELD,
MASONRY SAWS &
LOW H.P WALK
BEHINDS

HIGH SPEED DIAMOND BLADES

HAND HELD,
MASONRY SAWS &
LOW H.P WALK
BEHINDS

ASPHALT & GREEN CONCRETE



**ROAD RUNNER II
ASPHALT & GREEN CONCRETE**
Premium, Wet/Dry

12" x .125" x 1"	DAG12-XL
14" x .125" x 1"	DAG14-XL

BRICK/HARD MATERIAL



TIDAL WAVE®
Segmented Turbo, Dry/Wet,
.380" Segment Height

12" x .125" x 1"	WST12-7B
12" x .125" x 20mm	WST12-7B/20
14" x .125" x 1"	WST14-7B
14" x .125" x 20mm	WST14-7B/20



CARNIVORE® NICECUT
Pro Laser Welded, Dry/Wet,
.320" Segment Height

12" x .125" x 1"	CNC12-1
12" x .125" x 20mm	CNC12-1/20
14" x .125" x 1"	CNC14-1
14" x .125" x 20mm	CNC14-1/20
16" x .125" x 1"	CNC16-1

BRICK/HARD MATERIAL



COOL CUT™
Cured Concrete, Premium, Laser Welded,
Dry/Wet, .300" Segment Height

12" x .110" x 1"	DC12-1
12" x .110" x 20mm	DC12-1/20
14" x .110" x 1"	DC14-1
14" x .110" x 20mm	DC14-1/20
16" x .125" x 1"	DC16-1
18" x .125" x 1"	DC18-1



**SILVER BULLET™,
SEGMENTED TURBO - PRO SERIES,**
.375" Segment Height, Dry/Wet

12" x .125" x 1"	ST12-1
12" x .125" x 20mm	ST12-1/20
14" x .125" x 1"	ST14-1
14" x .125" x 20mm	ST14-1/20
16" x .125" x 1"	ST16-1
18" x .125" x 1"	ST18-1
20" x .125" x 1"	ST20-1

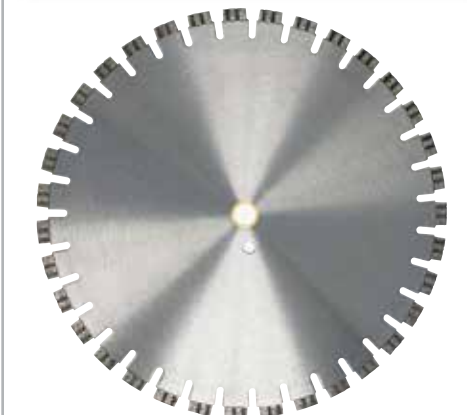

**SILENT CORE
PREMIUM SERIES**
.375 Segment Height, Dry/Wet
Laser Cut Core for Quiet Performance

14" x .125" x 1" / 20mm	SBX14-1
20" x .125" x 1"	SBX20-1

ECONOMY DIY GRADE



**DRY/WET CUTTING
SINTER WELDED**

14" x .125" x 1" / 20mm	SE14-4N
-------------------------	----------------



**HBRX SERIES™
HARD BRICK, ULTRA SUPREME™**
Laser Welded, Dry/Wet,
.380" Segment Height

12" x .125" x 1"	HBRX12-1
14" x .125" x 1"	HBRX14-1
14" x .125" x 1"	STHBRX14-1
16" x .125" x 1"	HBRX16-1
18" x .125" x 1"	HBRX18-1
20" x .140" x 1"	HBRX20-1



POWER COMBO® GPS
Segmented, Soft Bond, Laser Welded,
Dry/Wet, .300" Segment Height

12" x .125" x 1"	GPS12-1
12" x .125" x 20mm	GPS12-1/20
14" x .125" x 1"	GPS14-1
14" x .125" x 20mm	GPS14-1/20
16" x .125" x 1"	GPS16-1



COOL CUT™
Brick, Professional, Laser Welded, Dry/Wet,
.380" Segment Height

14" x .110" x 1"	DCU14-1-1
14" x .110" x 20mm	DCU14-1-1/20

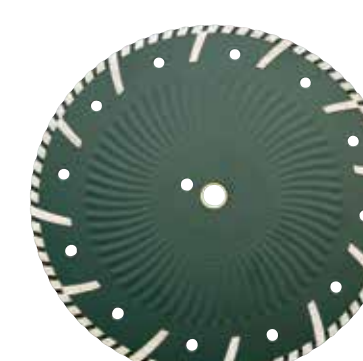

SUPER TURBO
General Purpose, Dry/Wet

12" x .125" x 1"	STGP12-H
14" x .125" x 1"	STGP14-H

HIGH SPEED DIAMOND BLADES

HAND HELD,
MASONRY SAWS &
LOW H.P WALK
BEHINDS

HIGH SPEED DIAMOND BLADES

HAND HELD,
MASONRY SAWS &
LOW H.P WALK
BEHINDS

BLOCK



POWER COMBO® GP
General Purpose, Premium, Laser Welded,
Dry/Wet, .300" Segment Height

12" x .125" x 1"	GP12-1
12" x .125" x 20mm	GP12-1/20
14" x .125" x 1"	GP14-1
14" x .125" x 20mm	GP14-1/20
16" x .125" x 1"	GP16-1



POWER COMBO® GPS
General Purpose, Premium, Laser Welded,
Dry/Wet, Soft Bond, .300" Segment Height

12" x .125" x 1"	GPS12-1
12" x .125" x 20mm	GPS12-1/20
14" x .125" x 1"	GPS14-1
14" x .125" x 20mm	GPS14-1/20
16" x .125" x 1"	GPS16-1



BLOCK BEAR® PRO BLOCK
Laser Welded, Dry/Wet,
BP Series .320" Segment Height,
BX Series .380" Segment Height

20" x .125" x 1" Silent	SBX20-1
20" x .140" x 1"	BP20-1
20" x .140" x 1"	BPM20-1
20" x .140" x 1"	BX20-1
20" x .140" x 1"	BXM20-1



POWER COMBO® GPX
General Purpose, Ultra Supreme, Laser
Welded, Dry/Wet, .380" Segment Height

12" x .125" x 1"	GPX12-1
12" x .125" x 20mm	GPX12-1/20
14" x .125" x 1"	GPX14-1
14" x .125" x 20mm	GPX14-1/20



SUPER GP®
General Purpose, Pro Series, Laser Welded,
Dry/Wet, .320" Segment Height

12" x .125" x 1"	SGP12-1
12" x .125" x 20mm	SGP12-1/20
14" x .125" x 1"	SGP14-1
14" x .125" x 20mm	SGP14-1/20
16" x .125" x 1"	SGP16-1
18" x .125" x 1"	SGP18-1



HEAVY-DUTY BLOCK
10mm Segment Height, Dry/Wet

12" x .125" x 1"	DC12-4N
12" x .125" x 20mm	DC12-4N-20
14" x .125" x 1"	DC14-4N
14" x .125" x 20mm	DC14-4N-20
20" x .140" x 1"	BX 20-4N

GENERAL PURPOSE



POWER COMBO® GP
General Purpose, Premium, Laser Welded,
Dry/Wet, .300" Segment Height

12" x .125" x 1"	GP12-1
12" x .125" x 20mm	GP12-1/20
14" x .125" x 1"	GP14-1
14" x .125" x 20mm	GP14-1/20
16" x .125" x 1"	GP16-1



POWER COMBO® GPS
General Purpose, Premium, Laser Welded,
Dry/Wet, Soft Bond, .300" Segment Height

12" x .125" x 1"	GPS12-1
12" x .125" x 20mm	GPS12-1/20
14" x .125" x 1"	GPS14-1
14" x .125" x 20mm	GPS14-1/20
16" x .125" x 1"	GPS16-1



SUPER GP®
General Purpose, Pro Laser Welded,
Dry/Wet, .320" Segment Height

12" x .125" x 1"	SGP12-1
12" x .125" x 20mm	SGP12-1/20
14" x .125" x 1"	SGP14-1
14" x .125" x 20mm	SGP14-1/20
16" x .125" x 1"	SGP16-1
18" x .125" x 1"	SGP18-1



POWER COMBO® GPX
General Purpose, Ultra Supreme: Laser
Welded, Dry/Wet, .380" Segment Height

12" x .125" x 1"	GPX12-1
12" x .125" x 20mm	GPX12-1/20
14" x .125" x 1"	GPX14-1
14" x .125" x 20mm	GPX14-1/20



THE PIRANHA - JUMBO SEG
General Purpose, Segmented Turbo, Wet/
Dry. SUPER JUMBO 15mm Segment Height

12" x .125" x 1" x 15mm	PST12-4N
14" x .125" x 1" x 15mm	PST14-4N



CARNIVORE® NICECUT
Pro Series, .315" Segment Height, Dry/Wet

12" x .125" x 1"	CNC12-1
12" x .125" x 20mm	CNC12-1/20
14" x .125" x 1"	CNC14-1
14" x .125" x 20mm	CNC14-1/20
16" x .125" x 1"	CNC16-1

HIGH SPEED DIAMOND BLADES

HAND HELD,
MASONRY SAWS &
LOW HP WALK BEHINDS

HIGH SPEED DIAMOND BLADES

HAND HELD,
MASONRY SAWS &
LOW HP WALK BEHINDS

GENERAL PURPOSE

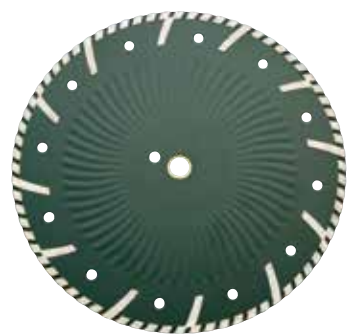

SUPER TURBO
General Purpose, Dry/Wet
12" x .125" x 1" / 20mm **STGP12-H**
14" x .125" x 1" / 20mm **STGP14-H**



HEAVY-DUTY GENERAL PURPOSE
10mm Segment Height, Dry/Wet
12" x .125" x 1" / 20mm **DC12-4N**
12" x .125" x 20mm **DC12-4N-20**
14" x .125" x 1" / 20mm **DC14-4N**
14" x .125" x 20mm **DC14-4N-20**
20" x .140" x 1" / 20mm **BX20-4N**



SUPER GP - JR.
General Purpose, Dry/Wet
12" x .125" x 1" / 20mm **SGPJ12-1**
14" x .125" x 1" / 20mm **SGPJ14-1**
14" x .125" x 20mm **SGPJ14-1/20**



ECONOMY - DIY GRADE
Dry/Wet Cutting, Sinter Welded
14" x .125" x 1" / 20mm **SE14-4N**



LASER WELDED - PREMIUM GRADE
Dry/Wet Cutting

Soft Bond
12" x .125" x 1" / 20mm **DCL12-D**
14" x .125" x 1" / 20mm **DCL14-D**
14" x .125" x 20mm **DCL14-D/20**
16" x .125" x 1" / 20mm **DCL16-D**
16" x .125" x 20mm **DCL16-D/20**

Hard Bond
14" x .125" x 1" / 20mm **DCLH14-D**
14" x .125" x 20mm **DCLH14-D/20**
16" x .125" x 1" / 20mm **DCLH16-D**
16" x .125" x 20mm **DCLH16-D/20**

DUCTILE IRON



BLUE THUNDER®
Pro Series, Dry/Wet
12" x .125" x 1" / 20mm **PDI12-7B**
12" x .125" x 20mm **PDI12-7B/20**
14" x .125" x 1" / 20mm **PDI14-7B**
14" x .125" x 20mm **PDI14-7B/20**
16" x .125" x 1" / 20mm **PDI16-7B**
16" x .125" x 20mm **PDI16-7B/20**



POWER COMBO® GPS
General Purpose, Premium Laser Welded,
Dry/Wet, Soft Bond, .300" Segment Height
12" x .125" x 1" / 20mm **GPS12-1**
12" x .125" x 20mm **GPS12-1/20**
14" x .125" x 1" / 20mm **GPS14-1**
14" x .125" x 20mm **GPS14-1/20**

METAL

Omnivore® is the first diamond blade that cuts raw metal and steel. In fact, the only diamond blade that cuts everything and does it four times faster than a conventional abrasive blade. Omnivore® is so hungry, it even outlasts abrasive wheels at least 30 to 1.

- Cuts steel, cast iron, ductile iron, rebar, concrete, 18-26 gauge roof decking, PVC and wood.
- Eliminates downtime changing abrasive wheels.
- Maintains consistent depths throughout cutting life.
- Available in 4", 4½", 6", 7", 8", 12", 14" and 16"

OMNIVORE® PRO SERIES

Pro Series, Dry/Wet

12" x .125" x 1" - 20mm **VBS12-7B**
12" x .125" x 20mm **VBS12-7B/20**
14" x .125" x 1" / 20mm **VBS14-7B**
14" x .125" x 20mm **VBS14-7B/20**
16" x .125" x 1" / 20mm **VBS16-7B**

Also available with Side Protection

12" x .125" x 1" / 20mm **VBSSC12-7B**
14" x .125" x 1" / 20mm **VBSSC14-7B**
14" x .125" x 20mm **VBSSC14-7B/20**
16" x .125" x 1" / 20mm **VBSSC16-7B**

TOP TEN REASONS TO USE THE OMNIVORE® VS. ABRASIVE

- This Blade will out last 30 to 50 abrasive wheels to 1
- Cuts faster and cleaner than abrasives
- Can be used wet or dry
- Saves money by reducing costs associated with down time from abrasive blade changes
- The Omnivore® maintains a consistent depth of cut through the entire life of the blade
- Much more environmental friendly than abrasives
- Easily fits on your chop saw, quickie saw, existing radial arm saw grinder and skill saws.
- The Omnivore® blades don't have fibers breaking apart and burning operator
- Less wear & tear on equipment & operator
- Guarantees lower cutting costs

STONE

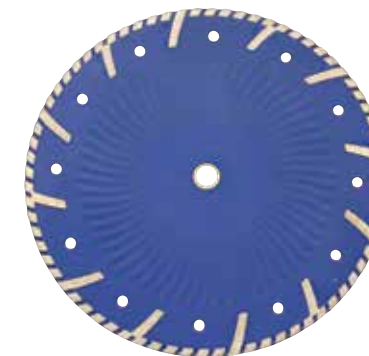

SUPER TURBO
Granite, Dry/Wet
12" x .125" x 1" - 20mm **STG12-H**
14" x .125" x 1" - 20mm **STG14-H**



**OFTEN IMITATED
NEVER DUPLICATED!**



CORING BITS

ADAPTERS &
ACCESSORIES

SECTION H



CORING BITS

ADAPTERS & ACCESSORIES



DIAMOND CORING BITS

COREBIT ADAPTERS AND ACCESSORIES



ADAPTERS

1" - 20mm Heavy Duty Adapter	HDA	12" Corebit Extension 5/8"-11	CBEX12/58
1 1/4"-7 Male Bottom - 5/8"-11 Female Top	BSA1	6" Corebit Extension 1 1/4"-7	CBEX6
5/8"-11 Male Bottom - 1 1/4"-7 Female Top	BSA2	6" Corebit Extension 5/8"-11	CBEX6/58
5/8"-11 - 3/8" Shank	DCBA-38	HILTI 1 1/4" -7 3 Keyholes	AD114H3
5/8"-11 - 1/2" Shank	DCBA-12	HILTI 1 1/4" -7 6 Keyholes	AD114H6
Flush Cut Adapter	FCA-4	5/8-11 To Sds Plus Adapter	AD58SDS
Adapter For Concrete Grinding	AGD-1	HILTI 5/8"-11 3 Keyholes	AD58H3
12" Corebit Extension 1 1/4"-7	CBEX12	HILTI 5/8"-11 6 Keyholes	AD58H6



PRO PRESTRESSED COREBITS

1" Pro Turbo Corebit	CBPS1-1
1 1/8" Pro Turbo Corebit	CBPS118-1
1 1/4" Pro Turbo Corebit	CBPS114-1
1 1/2" Pro Turbo Corebit	CBPS112-1
1 3/4" Pro Turbo Corebit	CBPS114-1
2" Pro Turbo Corebit	CBPS2-1
2 1/2" Pro Turbo Corebit	CBPS212-1
3" Pro Turbo Corebit	CBPS3-1
3 1/2" Pro Turbo Corebit	CBPS312-1
4" Pro Turbo Corebit	CBPS4-1
5" Pro Turbo Corebit	CBPS5-1
6" Pro Turbo Corebit	CBPS6-1

VACUUM BRAZED COREBITS 14" DEPTH

5/8" vacuum brazed corbits 14" drill depth	CBVB-5/8
3/4" vacuum brazed corbits 14" drill depth	CBVB-3/4
7/8" vacuum brazed corbits 14" drill depth	CBVB-7/8
1" vacuum brazed corbits 14" drill depth	CBVB-1
1 1/8" vacuum brazed corbits 14" drill depth	CBVB-118
1 1/4" vacuum brazed corbits 14" drill depth	CBVB-114
1 1/2" vacuum brazed corbits 14" drill depth	CBVB-112
2" vacuum brazed corbits 14" drill depth	CBVB-2
2 1/2" vacuum brazed corbits 14" drill depth	CBVB-212
3" vacuum brazed corbits 14" drill depth	CBVB-3
3 1/2" vacuum brazed corbits 14" drill depth	CBVB-312
4" vacuum brazed corbits 14" drill depth	CBVB-4
5" vacuum brazed corbits 14" drill depth	CBVB-5
6" vacuum brazed corbits 14" drill depth	CBVB-6
8" vacuum brazed corbits 14" drill depth	CBVB-8
9" vacuum brazed corbits 14" drill depth	CBVB-9
10" vacuum brazed corbits 14" drill depth	CBVB-10
12" vacuum brazed corbits 14" drill depth	CBVB-12



WET CUTTING

PRO - LONG LIFE

All come standard with extendable tops for easy core removal.

5/8"	CBP58-1
3/4"	CBP34-1
7/8"	CBP78-1
1"	CBP1-1
1 1/8"	CBP118-1
1 1/4"	CBP114-1
1 1/2"	CBP112-1
1 3/4"	CBP134-1
2"	CBP2-1
2 1/2"	CBP212-1
3"	CBP3-1
3 1/2"	CBP312-1
4"	CBP4-1
4 1/4"	CBP414-1
4 1/2"	CBP412-1
5"	CBP5-1
6"	CBP6-1
7"	CBP7-1
8"	CBP8-1
9"	CBP9-1
10"	CBP10-1
12"	CBP12-1
14"	CBP14-1
16"	CBP16-1



COREBITS BARREL EXTENSIONS FOR CBP AND CBX ONLY

1" Corebit Extension	CBEX1
1 1/8" Corebit Extension	CBEX118
1 1/4" Corebit Extension	CBEX114
1 1/2" Corebit Extension	CBEX112
2" Corebit Extension	CBEX2
2 1/2" Corebit Extension	CBEX212
3" Corebit Extension	CBEX3
4" Corebit Extension	CBEX4
5" Corebit Extension	CBEX5
6" Corebit Extension	CBEX6

PRO - TURBO SEG BIT - FAST CUT

Available with extendable tops.

5/8"	CBX58-1
3/4"	CBX34-1
7/8"	CBX78-1
1"	CBX1-1
1 1/8"	CBX118-1
1 1/4"	CBX114-1
1 3/8"	CBX138-1
1 1/2"	CBX112-1
1 3/4"	CBX134-1
2"	CBX2-1
2 1/2"	CBX212-1
3"	CBX3-1
3 1/2"	CBX312-1
4"	CBX4-1
4 1/4"	CBX414-1
4 1/2"	CBX412-1
5"	CBX5-1
5 1/2"	CBX512-1
6"	CBX6-1
6 1/4"	CBX614-1
7"	CBX7-1
8"	CBX8-1
9"	CBX9-1
10"	CBX10-1
11"	CBX11-1
12"	CBX12-1
13"	CBX13-1
14"	CBX14-1
16"	CBX16-1

DRY CUTTING



HAND HELD - LONG LIFE - BLUE BRICK/BLOCK

1"	DCB1-H
1 1/4"	DCB114-H
1 1/2"	DCB112-H
1 3/4"	DCB134-H
2"	DCB2-H
2 1/4"	DCB214-H
2 1/2"	DCB212-H
3"	DCB3-H
3 1/2"	DCB312-H
4"	DCB4-H
4 1/2"	DCB412-H
5"	DCB5-H
6"	DCB6-H

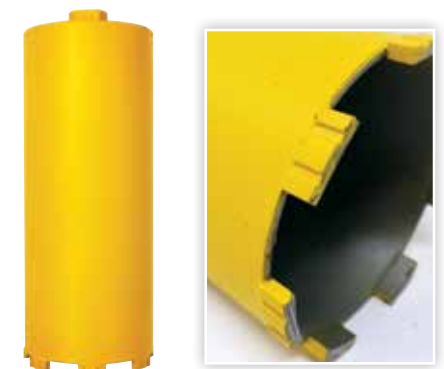

SOFT BOND - FAST DRILLING YELLOW - CONCRETE

1"	DCBC1-B
2"	DCBC2-B
3"	DCBC3-B
4"	DCBC4-B
5"	DCBC5-B
6"	DCBC6-B



MADE IN USA

SDS PLUS - SDS MAX

- Our bits incorporate revolutionary and dynamic designs that lead to faster speeds, quicker concrete removal, and increased productivity on jobsites.
- The patented design of these bits lead to reduced vibrations, even in the hardest concrete...as well as maximum energy transfer from the drill to the material.
- Special, geometric shape on the carbide tip and flute of these pro grade bits result in an enhanced hole roundness and improved dust release to flute. This also leads to superior dust removal and increased overall speed and production.
- Larger carbide size in tip leads to higher durability and longer productive bit life.

SDS PLUS BITS

5/32" x 2" x 4-1/4" SDS Plus	WVC100
5/32" x 4 x 6-1/4" SDS Plus	WVC101
3/16" x 2 x 4-1/4" SDS Plus	WVC102
3/16" x 4" x 6-1/4" SDS Plus	WVC103
3/16" x 6" x 8-1/4" SDS Plus	WVC104
3/16" x 8" x 10" SDS Plus	WVC105
3/16" x 10" x 12" SDS Plus	WVC106
7/32" x 4 x 6-1/4" SDS Plus	WVC112
7/32" x 6" x 8-1/4" SDS Plus	WVC113
7/32" x 8" x 10-1/2" SDS Plus	WVC114
1/4" x 2" x 4-1/4" SDS Plus	WVC115
1/4" x 4" x 6-1/4" SDS Plus	WVC116
1/4" x 6" x 8" SDS Plus	WVC117
1/4" x 8" x 10-1/2" SDS Plus	WVC118
1/4" x 12" x 14" SDS Plus	WVC119
5/16" x 4" x 6-1/4" SDS Plus	WVC120
3/8" x 6" x 8-1/4" SDS Plus	WVC122
3/8" x 10" x 12-1/4" SDS Plus	WVC123
3/8" x 4" x 6-1/4" SDS Plus	WVC124
3/8" x 16" x 18" SDS Plus	WVC125
1/2" x 4" x 6" SDS Plus	WVC128
1/2" x 8" x 10-1/4" SDS Plus	WVC127
1/2" x 10" x 12-1/4" SDS Plus	WVC129
1/2" x 16" x 18" SDS Plus	WVC130
5/8" x 4" x 6-1/4" SDS Plus	WVC140
5/8" x 6" x 8" SDS Plus	WVC137
5/8" x 10" x 12" SDS Plus	WVC138
5/8" x 16" x 18" SDS Plus	WVC139
3/4" x 6" x 8" SDS Plus	WVC142
3/4" x 10" x 12" SDS Plus	WVC143
3/4" x 16" x 18" SDS Plus	WVC144
7/8" x 6" x 8" SDS Plus	WVC146
7/8" x 8" x 10" SDS Plus	WVC147
7/8" x 10" x 12-1/4" SDS Plus	WVC148
1" x 8" x 10" SDS Plus	WVC150
1" x 16" x 18" SDS Plus	WVC151

SDS PLUS BITS



ZENTRO TIP



SDS MAX BITS

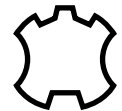

WDS715

- 1-3/4 square head with 16 steel teeth is ideal for leveling concrete walls or floors
- Pointed tooth design also can be used for roughing a concrete surface to produce a desired finish
- Shot peened for added strength and surface hardness
- Clear coated to further enhance product quality
- SDS-MAX shank



State of the art technology and materials, superior workmanship, and strict quality control standards assure this superior line of hard working tools maximize efficiency and value on a cost per hole basis.

SDS PLUS - SDS MAX

MISC CHISELS

12" Bull Point Chisel SDS MAX	WDS710
18" Bull Point Chisel SDS MAX	WDS711
1" x 12" Flat Chisel SDS MAX	WDS712
1" x 18" Flat Chisel SDS MAX	WDS713
1" x 24" Flat Chisel SDS MAX	WDS713-24
2" x 12" Scaling Chisel SDS MAX	WDS707
3" x 12" Scaling Chisel SDS MAX	WDS714
3" x 18" Scaling Chisel SDS MAX	WDS714-18
Bushing Tool SDS MAX	WDS715

SDS MAX BITS

1/2" x 8" x 13" SDS MAX	VC211
1/2" x 16" x 21" SDS MAX	VC212
9/16" x 8" x 12" SDS MAX	VC215
9/16" x 16" x 21" SDS MAX	VC216
5/8" x 8" x 13" SDS MAX (ZENTRO)	VC219
5/8" x 16" x 21" SDS MAX (ZENTRO)	VC220
3/4" x 8" x 13" SDS MAX (ZENTRO)	VC224
3/4" x 17" x 21" SDS MAX (ZENTRO)	VC225
7/8" x 8" x 13" SDS MAX (ZENTRO)	VC230

7/8" x 17" x 21" SDS MAX (ZENTRO)	VC231
1" x 17" x 21" SDS MAX (ZENTRO)	VC233
1" x 8" x 13" SDS MAX (ZENTRO)	VC234
1" x 31" x 36" SDS Max (ZENTRO)	VC236
1-1/8" x 12" x 17" SDS MAX (ZENTRO)	VC239
1-1/8" x 17" x 21" SDS MAX (ZENTRO)	VC240
1-1/4" x 10" x 15" SDS MAX (ZENTRO)	VC241
1-1/4" x 18" x 23" SDS MAX (ZENTRO)	VC242
1-3/8" x 18" x 23" SDS MAX	VC245
1-1/2" x 18" x 23" SDS MAX	VC247

WDS710

Bull Point Chisel

- Solid all purpose tool used for general concrete demolition
- Sharp four sided design on point end assures quick and easy penetration
- Shot peened for added strength and surface hardness
- Clear coated to further enhance product quality
- SDS-MAX shank



WDS711

Bull Point Chisel

- Very popular all purpose tool used for general concrete demolition
- Sharp four sided design on point end assures quick and easy penetration
- 18 in. overall dimension is ideal for applications requiring longer usable length
- Shot peened for added strength and surface hardness
- Clear coated to further enhance product quality
- SDS-MAX shank



WDS712

Flat Chisel

- Solid all purpose tool used for general concrete demolition
- Sharp blade design of chisel end assures quick and easy penetration and enhanced cutting angle
- Shot peened for added strength and surface hardness
- Clear coated for increased product quality
- SDS-MAX shank

WDS714 & WDS714-18

Scaling Chisel

- Quite popular concrete demolition tool utilized mainly for scaling applications
- 3 in. wide blade allows for efficient scaling in a variety of general demolition type work involving concrete, asphalt, and tile
- Shot peened for added strength and surface hardness
- Clear coated to further enhance product quality
- Available 12" and 18"
- SDS-MAX shank



WDS707

Scaling Chisel

- Very popular all purpose tool used for general concrete demolition
- 2 in. wide blade increases overall efficiency in all scaling applications
- Sharp blade design of chisel end assures quick and easy penetration and enhanced cutting angle
- Shot peened for added strength and surface hardness
- Clear coated for increased product quality
- SDS-MAX shank

WDS713 & WDS713-24

Flat Chisel

- Very popular all purpose tool used for general concrete demolition
- Sharp blade design of chisel end assures quick and easy penetration and enhanced cutting angle
- WDS713 = 18 in. WDS713-24 = 24in. overall dimension is ideal for applications requiring longer usable length
- Shot peened for added strength and surface hardness
- Clear coated to further enhance product quality
- SDS-MAX shank



SPECIALTY BLADES

SECTION I



SPECIALTY TOOLING

SPECIALTY BLADES

OMNIVORE®/METAL

Omnivore® is the first diamond blade that cuts raw metal and steel. In fact, it's the only diamond blade that cuts everything and does it four times faster than a conventional abrasive blade. Outlasts abrasive wheels at least 30 to 1.

- Cuts steel, cast iron, ductile iron, rebar, concrete, 18-26 gauge roof decking, PVC and wood
- Eliminates downtime changing wheels
- Maintains consistent depth of cut
- Available: 4", 4½", 5", 6", 7", 8", 9", 10", 12", 14"



OMNIVORE® PRO SERIES Dry/Wet

4" x .080" x 7/8"-5/8"	VBS4-7B
4½" x .080" x 7/8"-5/8"	VBS4.5-7B
4½" x .050" x 7/8"-5/8"	VBT4.5-7B
5" x .080" x 7/8"-5/8"	VBS5-7B
6" x .080" x 7/8"-5/8"	VBS6-7B
6" x .050" x 7/8"-5/8"	VBT6-7B
7" x .095" x universal	VBS7-7B
7" x .060" x 7/8"-5/8"	VBT7-7B
8" x .095" x universal	VBS8-7B
9" x .095" x 7/8"-5/8"	VBS9-7B
10" x .095" x 1" - 7/8"-5/8"	VBS10-7B
12" x .125" x 1"	VBS12-7B
12" x .125" x 20mm	VBS12-7B/20
14" x .125" x 1"	VBS14-7B
14" x .125" x 20mm	VBS14-7B/20
16" x .125" x 1"	VBS16-7B

W / SIDE PROTECTION

12" x .125" x 1"	VBSSC12-7B
12" x .125" x 20mm	VBSSC12-7B/20
14" x .125" x 1"	VBSSC14-7B
14" x .125" x 20mm	VBSSC14-7B/20
16" x .125" x 1"	VBSSC16-7B

OMNIVORE II® PRO SERIES

Dry/Wet	
14" x .125" x 1"	VB02-14



RING SAW BLADES

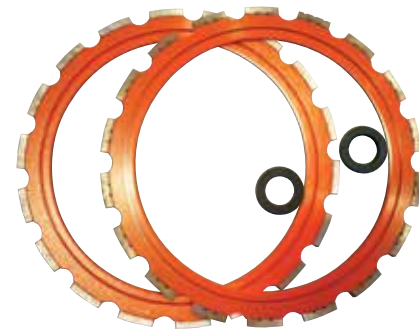

PRO-MEDIUM BOND - FOR LONG LIFE

14" x .140"	DC14-3
14" x .220"	DC14-3-9

PRO-NOTCHED SEG SOFT BOND FOR FAST CUTTING

14" x .140"	DCNS14-3
-------------	-----------------

PREMIUM MEDIUM BOND CROWN SEG

14" x .140"	RSB-14-1
-------------	-----------------

VACUUM BRAZED

14" x .140"	VBRS-14
-------------	----------------

RESCUE/MULTI-PURPOSE

This is a true rescue blade. Used by fire departments, demo and wrecking companies, and city municipalities, this blade always gets the job done.



CARBIDE CHUNK GRINDER

4" x .250" x 7/8" x 5/8"	TRSC-4
7" x .250" x 7/8" x 5/8"	TRSC-7
12" x 1"	TRSC-12
12" x 20mm	TRSC-12/20
14" x 1"	TRSC-14
14" x 20mm	TRSC-14/20
16" x 1"	TRSC-16

MULTI-CUT AND GRIND

These are the first of their kind! You can cut, grind and flush cut all with the same blade. Because of its unique depressed center, you can use it with any standard grinder.



ELECTROPLATED

4" x .080" x 7/8" - 5/8"	EMCG4-1
4½" x .080" x 7/8" - 5/8"	EMCG4.5-1
5" x .080" x 7/8" - 5/8"	EMCG5-1



IMPREGNATED

4" x .100" x 7/8" - 5/8"	MCG4-1
4½" x .100" x 7/8" - 5/8"	MCG4.5-1
5" x .100" x 7/8" - 5/8"	MCG5-1

CARBIDE TIP

7 1/4" CARBIDE TIP BLADES

This professional series 24/40 tooth, C3 carbide tipped blade has the quality pro framers need, at prices that any contractor can afford.

24 Tooth	CT7-24-3
40 Tooth	CT7-40-3



JOINT CLEAN OUT



12" Wire wheel clean out 1" WPH **WW12-D**

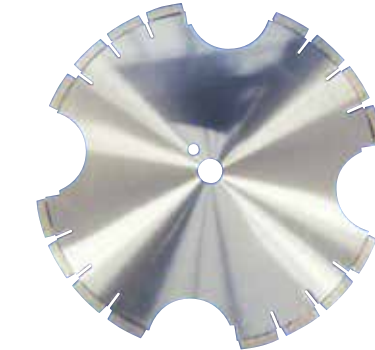

14" NINJA cleanout blade x .250" **NB14-10**

VACUUM BRAZED TOOLS



1" 30/40 grit w/ 1/4" Shank	VBS1-30/40
2" 30/40 grit w/ 1/4" Arbor	VB2-30/40
2" 30/40 grit w/ 1/4" Shank	VBS2-30/40
2" 40/50 grit w/ 1/4" Shank	VBS2-40/50
3" 30/40 grit w/ 1/4" Arbor	VB3-30/40
3" 30/40 grit w/ 1/4" Shank	VBS2-30/40
3" 40/50 grit w/ 1/4" Shank	VBS3-40/50

GRINDER DISCS



CONCRETE GRINDING DISCS

4 1/2" x 7/8" x 36 Grit	GRD4.5-1/36
4 1/2" x 7/8" x 24 Grit	GRD4.5-1/24
4 1/2" x 7/8" x 16 Grit	GRD4.5-1
4 1/2" x 7/8" x 8 Grit	GRD4.5-1/8
7" x 7/8" x 36 Grit	GRD7-1/36
7" x 7/8" x 24 Grit	GRD7-1/24
7" x 7/8" x 16 Grit	GRD7-1
7" x 7/8" x 8 Grit	GRD7-1/8
7/8" to 5/8" 11 Threads - Adapter	AGD-1

DIE GRINDER AND FORM TOOLS



ELECTROPLATED DIE GRINDER & FORM TOOLS

2" Premium	E2-1
3" Premium	E3-1
1" w/ 1/4" Shank Pro	EXS1-1/14
2" Pro	EP2-1
2" w/ 1/4" Shank Pro	EXS2-1/14
2" w/ 3/8" Shank Pro	EXS2-1/38
3" Pro	EXS3-1
3" w/ 1/4" Shank Pro	EXS3-1/14

DIAMOND BEADED WIRE & ACCESSORIES

DIAMOND BEADED WIRE

For use on wire saws for cutting reinforced concrete, masonry stone and metals. Available in two styles for GP cutting or Vacuum Brazed for Heavy Steel. This wire has 11mm Beads and has 40 beads per meter. Sold by the foot.



DIAMOND WIRE

Diamond Wire Impregnated General Purpose Per Foot
Diamond Wire Vacuum Brazed Heavy Steel Per Foot

GPWIRE
VBWIRE

DIAMOND WIRE ACCESSORIES

Diamond Wire Cutters
Hydraulic Crimpers For Diamond Wire
Crimps For Diamond Wire

WCUT
HCRIMP
CRIMPS

VBWIRE



GPWIRE

DIAMOND WIRE USE & TROUBLESHOOT

GENERAL TIPS AND ADVICE BEFORE STARTING ANY WIRE CUTTING JOB



DRY SAWING

1. Use plated or vacuum brazed wire
2. Use very high diamond con beads (above 100)
3. Reduce the load on the wire.
4. Reduce the rotation speed to 49ft./s
5. If you have a cooling system other than water, use it as it will protect the rubber from melting.
6. Try to use a longer wire as it will increase the air cooling time of the wire.
7. Check the uneven wear on the wire and correct the number of pre-twist if necessary.

WIRE TWISTING / CRIMPING

1. Lock one end of wire.
2. Hold on to the other end and face the wire.
3. Twist clockwise (1 Twist / 2ft. of wire length).
4. Loop the cable and crimp the connection
5. Rotate the crimp 90 degrees before each crimp. Do not crimp along the same line.
6. If wire is broken, before crimping again, it is advised to cut the 3 beads from each end before crimping.
7. Assure that THERE IS NO LOOSE WIRE OR RUBBER AT THE SURFACE TO BE CRIMPED.
8. Always allow 50% of cable length on each end to be inside the crimped and they are budded tight together.

WIRE CUTTING PROBLEMS / TROUBLESHOOTING

1. **FLAT SPOT ON THE BEADS:**
 - a. Not enough pre-twisting – Increase twist per ft. of wire if severe flat is forming.
 - b. Too high load on the wire – Reduce the pulling force on the wire.
 - c. Not enough cooling – Increase water flow or reposition water source.
2. **HIGH BEAD CONICITY:**
 - a. Not enough cooling – Increase water flow or reposition water source.
 - b. Too high wire speed – Reduce wire speed.
 - c. Beads not adapted to the material abrasiveness – Change wire specification
3. **CRIMP LENGTH CHANGE DURING USE:**
 - a. Too small pulley – crimp is being stretched during every turn
 - b. Too close to the diameter of beads
 - c. Too much force
 - d. Too soft crimp material
4. **WIRE BREAKAGE:**
 - a. Over load on the wire – Reduce the tension of wire
 - b. Pulley with too small radius. – Use a swivel connection
 - c. Shocks on the connection due to large diameter – Move to a smaller diameter crimp
 - d. Shocks when starting the cut – Break/round the edges before starting
5. **HARD TO START – WIRE DOES NOT START AND IS MOVING OR SLIPPING ON THE DRIVE WHEEL:**
 - a. Reduce tensioning on the wire.
 - b. Break sharp edges before starting.
 - c. Add a pulley in a way to open the angle between the wire and the piece being cut reducing the contact surface with the material.

IMPORTANT TOOLS

1. Use Hydraulic crimping Tool kit to assure crimping is consistent and controlled.
2. Use extended water nozzle to be able to reach into the cut to flush out the sludge created during cut.
3. Use extra pulleys to break sharp entry to the work piece.



DIAMOND CHAIN & EQUIPMENT

PRODUCTS AND ACCESSORIES

SECTION J



DIAMOND CHAIN EQUIPMENT & ACCESSORIES

**ORDERS MUST REFLECT
TOTAL AMOUNT OF LINKS PER CHAIN.**

DIAMOND CHAIN & ACCESSORIES

695XL

Equipped with integrated water delivery system that continuously feeds water to the blade, the 695XL features also include: an easy-to-start engine with higher energy ignition system and durable, long-lasting components including a new muffler, carburetor and piston & cylinder. Based on the best-selling 695 power cutter platform, the 695XL is the highest horsepower ICS gas power cutter for frequent-use by general construction, utility contractors and concrete professionals.



ITEMS

695XL Powerhead Only - (NO BAR/CHAIN)

ICS581192

GUIDEBAR & CHAINS

10" Guidebar fits 880F4	ICS529829
Pro Force - 10" Chain	ICS531743
13" Guidebar fits 814PRO	ICS74042
Twin Pro 13" Chain	ICS74719
15" Guidebar fits 880F4	ICS523080
Twin Pro 15" Chain	ICS525342
20" Guidebar fits 880F4/880F4-FL	ICS529767
Pro Force - 20" Chain	ICS531749
25" Guidebar fits 880F4	ICS525320
Twin Pro - 25" Chain	ICS525345



GAS BARS AND CHAINS

12" Guidebar fits 680GC (same as BG12)	ICS71395
Twinmax-29 12" Chain	ICS71400
Twinmax-Plus 29 12" Chain	ICS71704
14" Guidebar fits 695GC /633GC	ICS71395
14" Guidebar fits 680GC	ICS71486
Twinmax-32 14" Chain	ICS71486
Winmax Plus-32 14" Chain	ICS71705T
16" Guidebar fits 695GC /633GC	ICS71600
Twinmax-32 14" Chain	ICS71607
Winmax Plus-35 16" Chain	ICS71706

890 SERIES

The ICS 890 Series hydraulic cutting system offers the superior strength of FORCE4® technology and is equipped with integrated water delivery system that continuously feeds water to the blade. From the redesigned, more durable rear handle, to the easy to replace drive sprocket, this hydraulic power cutter is engineered to stand up to your toughest jobs. In a package that exceeds industry standards, this sleek powerhouse is packed with features designed to make it work as hard as you do.



890 SERIES HOSE WHIPS

ITEMS

890F4-FLUSH Powerhead 12 gpm/45 lpm, 1 ft/30 cm hose whips	ICS566114
890F4-FLUSH Powerhead 8 gpm/30 lpm, 1 ft/30 cm hose whips	ICS566113

ITEMS

890F4 Powerhead 12 gpm/45 lpm, 1 ft/30 cm hose whips	ICS566112
890F4 Powerhead 8 gpm/30 lpm, 1 ft/30 cm hose whips	ICS566110

HYDRAULIC BARS, CHAINS, SPROCKETS AND MISC ACCESSORIES

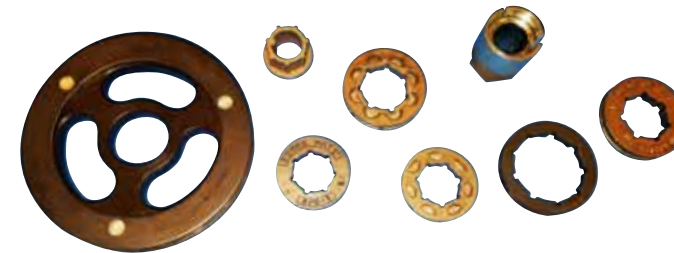

SPROCKETS AND MISC ACCESSORIES

ICS® Sprocket fits all 890	ICS565065
ICS® Sprocket fits all 890 flush cut	ICS565066
ICS® Sprocket fits 814 pro	ICS71385
ICS® Sprocket fits all 633, 680, 695 gas saws	ICS70949

Sprocket for 814 pro	SPK-0700
Sprocket for 603/ Redzaw® RZ60, 613/680, 633	SPK-0800
Sprocket for k950/k960 gas saws	SPK-0900
Sprocket for 823, 853, 880	SPK-1400
Sprocket for 890	SPK-890
Sprocket for 890 flush cut	SPK-890FL
Spacer for 880/853 to fit with 16mm shaft	TLOCK
Spacer for 853/823 originals to fit with 14mm shaft	TLOCK2

New chain kit	CA600011
Riveting break punch	CA600015
Riveting punch	CA600017

HYDRAULIC BARS/LINKS

13" Guidebar Fits RGC® mini /814 pro - 50 Links	BH13-MINI
15" Guidebar Fits RGC® mini /814 pro - 55 Links	BH15-MINI
15" Guidebar Fits RGC® SS15 - 76 Links	BH15-SS15
20" Guidebar Fits RGC® SS15 - 88 Links	BH20-SS15
11" Guidebar Fits 823, 853, 890 - 56 Links	BH11
13" Guidebar Fits 823, 853, 890 - 61 Links	BH13
15" Guidebar Fits 823, 853, 890 - 66 Links	BH15
19" Guidebar Fits 823, 853, 890 - 78 Links	BH19
24" Guidebar Fits 823, 853, 890 - 94 Links	BH24
30" Guidebar Fits 823, 853, 890 - 110 Links	BH30

GAS BARS / LINKS

10" Guidebar Fits 603/Redzaw RZ60 48 Links	BG10
12" Guidebar Fits 603/Redzaw RZ60 54 Links	BG12-1254
12" Guidebar Fits 633, k960, k970 58 Links (same as ICS® 71395)	BG12
14" Guidebar Fits 633, k960, k970 64 Links (same as ICS® 73600)	BG12
16" Guidebar Fits STIHL GS 461 rock boss 64 Links	BG16-GS461
16" Guidebar Fits 633, k960, k970 64 Links (same as ICS® 71600)	BG16

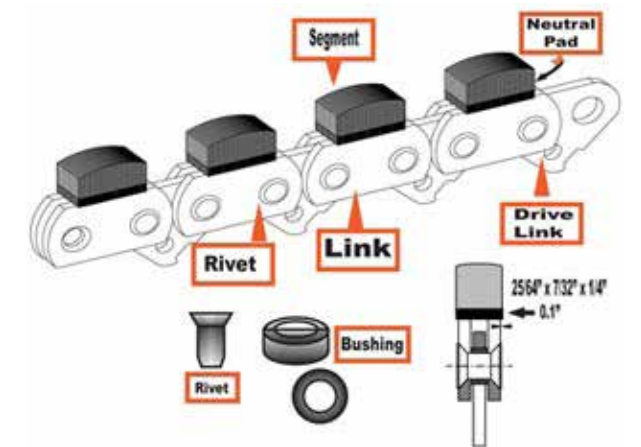

CHAIN LINKS-PER LINK PRICING

WDS PRO - Gas Chain	HCLH
WDS PRO - Hydraulic Chain	HCLP
WDS PRO - Ductile Iron Chain	GCDI

SEGMENTS QUALITY

1. Unique sandwich segment design maintains segment profile throughout chain life.
2. The sandwich design has harder outer shell that keeps the segment's profile throughout its life. The use of a soft bond in the center enables fast cutting, especially in heavy steel.
3. Allows the segment to work all the way.
4. Only top quality diamonds are used in the bond which increases speed and life.

SEGMENT ON EVERY LINK

1. Longer life.
2. More torque can be placed on chain and bar due to less spacing.
3. Gives greater life – up to 30% more surface area.
4. Chain stretching is reduced because of pressure on each segment is lower.
5. Cuts significantly faster when cutting through heavy reinforced concrete. More diamonds in contact with the material.

SDS-MAX CHIPPING HAMMER W/ CARRY CASE - MHEV 5 BL

PART # 600769620

High breaking performance thanks to maintenance-free brushless motor and high-performance hammer action
 Long service life thanks to brushless technology and robust aluminum die-cast housings of gear and motor Metabo Vibra-Tech (MVT) with double dampening: Decoupled handle and impact-absorbing counter-oscillating weight actively reduce vibrations for healthy working also in continuous use.

Ergonomically shaped, slim gripping area with large speed control trigger for comfortable working

Easily accessible locking switch for chiselling in continuous mode

Vario-Tacho-Constamatic (VTC)-Full Wave Electronics for work with materials requiring customized speeds, which remain constant under load Optional reduction of the impact energy for working in softer materials

Electronic soft start for smooth start-up

Restart protection: prevents unintentional start-up after power supply interruption

Low-dust chiseling with external dust extraction ESA max (accessories)

Overload protection: protects the motor from overheating

The adjustable front handle can be rotated 360° and the angle adjusted for an optimum working position

- Max. single blow energy (EPTA): 8,7 J
- Maximum impact rate: 2.900 bpm
- Rated input power: 1.150 W
- Bit retainer: SDS-max
- Weight (without power cable): 17,4 lbs
- Cable length: 6 m

Scope of delivery:

Side handle, Front handle, Lubricant for tool shank end, Duster, Plastic carry case



SDS-MAX CHIPPING HAMMER W/ CARRY CASE - MHEV 11 BL

PART # 600770620

High breaking performance thanks to maintenance-free brushless motor and high-performance hammer action
 Long service life thanks to brushless technology and robust aluminum die-cast housings of gear and motor Metabo Vibra-Tech (MVT) with double dampening: Decoupled handle and impact-absorbing counter-oscillating weight actively reduce vibrations for healthy working also in continuous use.

Ergonomically shaped, slim gripping area with large speed control trigger for comfortable working

Easily accessible locking switch for chiseling in continuous mode

Optional reduction of the impact energy for working in softer materials

Vario-Tacho-Constamatic (VTC)-Full Wave Electronics for work with materials requiring customized speeds

The adjustable front handle can be rotated 360° and the angle adjusted for an optimum working position

Electronic soft start for smooth start-up

Restart protection: prevents unintentional start-up after power supply interruption

Overload protection: protects the motor from overheating

Low-dust chiseling with external dust extraction ESA max (accessories)

- Max. single blow energy (EPTA): 18 J
- Maximum impact rate: 2.100 bpm
- Rated input power: 1.500 W
- Bit retainer: SDS-max
- Weight (without power cable): 26.9 / 27 lbs
- Cable length: 6m

Scope of delivery:

Rubber-coated side handle, Drilling depth guide, Lubricant for tool shank end, Duster, Plastic carry case



SDS MAX HAMMER / ROTATE DUST EXTRACTION KIT W/ CARRY CASE FOR VACUUM

PART # 623271000

- For extraction from the power tool in continuous mode. Especially suited for extracting concrete and rock dust
- For drilling and chiseling - with different drill attachments from Ø 16-52 mm, pointed and flat chisels up to 25 mm
- Installation without tools - drills and chisels can be exchanged without removing the extraction - External dust extraction
- Compatible with all new Metabo SDS-max hammers in conjunction with all Metabo M and H extraction sets



ELECTRONIC COMBINATION HAMMER W/ CARRY CASE - KHE D-26

PART # 601109420

Combination hammer with 3 functions: hammer drilling, drilling and chiseling
 Spade grip handle for greatest work comfort and maximum productivity when working above the head or facing downwards
 Vario (V)-Electronics for working at customized speeds to suit various application materials

High performance hammer action, precisely mounted in a housing made of aluminum alloy: long-lasting and robust

Metabo S-automatic safety clutch: mechanical decoupling of the drive for safe working should the drill stop unexpectedly

Lockable switch for comfortable working in continuous operation

Scaffolding hook for easy and safe temporary storage of the hammer on scaffoldings and ladders

- Max. single blow energy (EPTA): 2,3 J
- Maximum impact rate: 5.400 bpm
- Rated input power: 800 W
- Drill-Ø concrete with hammer drills: 26 mm
- Drill-Ø masonry with core bits: 68 mm
- Drill Ø steel: 13 mm
- Drill-Ø soft wood: 30 mm
- No-load speed: 0 - 1.150 rpm
- Revolutions at rated load: 960 rpm
- Bit retainer: SDS-plus
- Collar diameter: 43 mm
- Weight (without power cable): 2,9 kg

Scope of delivery:

Hammer chuck for tools with SDS-plus shank end, Side handle, Drilling depth guide, Plastic carry case



- Max. single blow energy (EPTA): 8,7 J
- Maximum impact rate: 2.900 bpm
- Rated input power: 1.100 W
- Drill-Ø concrete with hammer drills: 40 mm
- Drill-Ø masonry with core bits: 105 mm
- No-load speed: 350 / 500 rpm
- Revolutions at rated load: 350 / 500 rpm
- Bit retainer: SDS-max
- Collar diameter: 64.6 mm
- Weight (without power cable): 18.3 lbs

SDS-MAX COMBINATION HAMMER / ROTATE WITH CARRY CASE - KHEV 5-40 BL

PART # 600765620

Maximum drilling progress and high breaking performance thanks to maintenance-free brushless motor and high-performance hammer action.

Combination hammer with 2 functions: hammer drilling and chiseling
 Metabo VibraTech (MVT) with double dampening: Decoupled handle and impact-absorbing counter-oscillating weight actively reduce vibrations for healthy working also in continuous use.

Easily accessible locking switch for chiseling in continuous mode

Vario-Tacho Constamatic (VTC)-Full Wave Electronics for work with materials requiring customized speeds, which remain constant under load

Optional reduction of speed and impact energy for working in softer materials
 Electronic soft start for precise spot-drilling

Metabo S-automatic safety clutch: mechanical decoupling of the drive for safe working should the drill stop unexpectedly

Restart protection: prevents unintentional start-up after power supply interruption

Overload protection: protects the motor from overheating

Low-dust chiseling and drilling with external dust extraction

ESA max (accessories)

THE RIPPER

HAND HELD SAW



DIAMOND PRODUCTS EQUIPMENT

WDS THE RIPPER® SAW

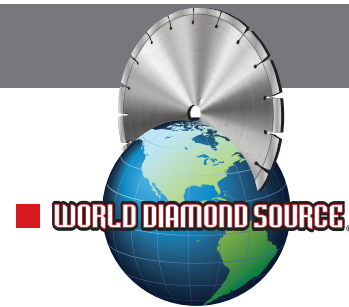

HYDRAULIC CONCRETE HAND SAW

Standard Features:

- Sturdy all welded aluminum powder coated frame.
- Heavy Duty large dual position front handle for easy control.
- Water shut-off valve and manifold block positioned to avoid any chance of damage.
- Highly efficient hydraulic motor choice for both strong blade speed and torque delivery.
- All saws include standard 3 foot hose whips including flush face quick disconnects. Hydraulic handsaw motors used vary based on powder pack engine & pump sizes. The motors are matched to your specific power pack needs.
- Stainless steel blade collar held in place with stainless retainer washer & screw attached to motors center taped shaft.
- Our hydraulic control valve will no longer have o-rings or seal leaks, the new valve has a life-time warranty against leaks.
- Leading our industry with our new design improvement to our handsaw is the three bolt replicable Rear Splash Guard, no more welding up the holes and cracks to repair. Simply replace.

Standard Model:

16-CHS	16" Hand Saw FRAME ONLY no motors
20-CHS	20" Hand Saw FRAME ONLY no motors
24-CHS	24" Hand Saw FRAME ONLY no motors
30-CHS	30" Hand Saw FRAME ONLY no motors

Size Options:

16" (Cutting Depth: 6")
20" (Cutting Depth: 8")
24" (Cutting Depth: 9.5")
30" (Cutting Depth: 12")

Flush-Cut Model:

16-FCHS	16" Flush Cut Hand Saw Frame Only No Motors
20-FCHS	20" Flush Cut Hand Saw Frame Only No Motors
24-FCHS	24" Flush Cut Hand Saw Frame Only No Motors
30-FCHS	30" Flush Cut Hand Saw Frame Only No Motors

Motor Options:

CASSMOTOR12	Casappa 12-GPM Motor for Hand Saw
CASSMOTOR15	Casappa 15-GPM Motor for Hand Saw
MARZ-8	Marzocchi 8-Gpm Motor For Hand Saw
MARZ-12	Marzocchi 12-Gpm Motor For Hand Saw
MARZ-15	Marzocchi 15-Gpm Motor For Hand Saw

Motor Seal Kits:

MSKC	Motor Seal Kit For Casappa Motor
SSC-1	Shaft Seal Only For Casappa Motor
MSK	Motor Seal Kit For Marzocchi Motor
SSM-1	Super Seal For Marzocchi Motor

Hose Options:

50H	50' - 1/2" Hydraulic Hose W/ Flush Face Quick Connects
------------	--

Replacement parts:

WDSSG-1	Replacement Dovetail Slurry Guard
WDSSG-FC	Replacement Dovetail Slurry Guard (Flush Cut)
COL-1	Replacement Stainless Steel Blade Collar



CC150XL-EE FIRST-CUT™ SAW

Light Weight & Portable

- Reliable skid plate system for green concrete
- Spring-loaded skid plate that stays down on the surface to help prevent spalling
- Heavy duty design but light weight enough for two people to lift
- Fully adjustable handle bars for operator comfort
- Five wheels under the frame for increased stability
- Cyclone air filter for increased air flow
- Up-cut design to keep debris from going back in the cut
- Blade raise/lower mechanical mechanism with spring loaded release
- Single ribbed drive belt
- Includes vacuum attachment guard plate
- Max. Depth of Cut: 1.5" with 6.5" diameter blade
- Blade Shaft RPM: 4020
- Blade Shaft Diameter: 1-1/4"
- Arbor Size: 1"
- Depth Indicator: Standard
- Dimensions: 16.94" wide, 21.80" tall, 32.92" long



CC5049DC - FRONT PIVOT SAW

NEW

14"-42" Blade Capacity - Diesel

- Certified EPA/CARB Tier 4 Engine for clean reliable power with Caterpillar's latest engine technology
- Up to 17-1/2" deep sawing with 42" blade and 7" quick disconnect flanges
- Adjustable blade lowering speed that is dash mounted for quick, precise adjustment
- Single hand sawing control with forward/reverse/raise/lower all in one ergonomic grip
- Three position handle bars set and lock at comfortable, preferred angles
- Large 6 gallon fuel tank with convenient left side filler door along with electronic low fuel level indication
- Quick access rear cover screen for inspecting and service with simple latch convenience
- Heavy duty wheels with durable polyurethane tread on front and thick rubber tread on the rear
- Automatic parking brake with hydraulic activation in stop position gate
- Robust blade shaft offers reliable support from 2 pillow block style, precision ball bearings
- Spline drive PTO gives precision zero side load drive to dampen vibration and shock loads
- Advanced air cleaner with radial seal primary and secondary filters with maintenance indicator
- Sealed electronic protection resists heat, moisture, shock and vibration

Includes: Telescoping front and rear pointers, fuel cooler, low coolant level sensor, oil drain valve, air restriction indicator, travel speed push/pull cable, positive front axle depth stop, slip-on blade flange guard, polycarbonate decals, blade shaft wrench

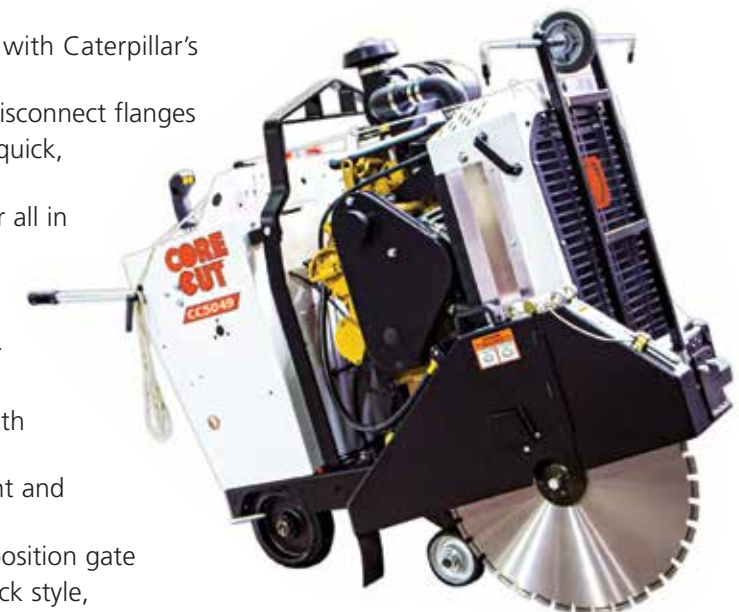

Blade not included



C16 ELECTRIC FLUSH-OUT HAND HELD SAW

Features & Benefits:

- Wet or dry cutting
- Overload protection with load warning LED light, visible to operator
- Electrical cord with PRCD protection
- Detachable guide rollers
- Splash guard to protect from water spray
- Handles designed for optimal control
- Tool-free blade guard angle adjustment
- Lightweight magnesium blade guard
- Externally accessible motor brushes
- Standard water feed system with fine adjustable flow and quick release coupling and durable hose

Specifications:

Power Input:	25A
Voltage:	120V
RPM:	3900
Arbor:	1" plus Long Year Flush Cut
Max. Cutting Depth:	6"
Cut Direction:	Down
Weight:	17 lbs. (18 lbs. with guide rollers)

1. Dust Port
2. LED Overload Light
3. Guide Rollers
4. Magnesium Blade Guard
5. Water Feed System
6. Latching Flush Cut Guard



Flush cutting is easy with removable side guard



Removable guard side for flush cutting
(Flush-cut bolt pattern required on blade in order to cut flush)

C14 ELECTRIC HAND HELD SAW

Features & Benefits:

- Wet or dry cutting
- Overload protection with load warning LED light, visible to operator
- Electrical cord with PRCD protection
- Detachable guide rollers
- Splash guard to protect from water spray
- Handles designed for optimal control
- Tool-free blade guard angle adjustment
- Lightweight magnesium blade guard
- Externally accessible motor brushes
- Standard water feed system with fine adjustable flow and quick release coupling and durable hose

Specifications:

Power Input:	15A
Voltage:	120V
RPM:	4500
Arbor:	1"
Max. Cutting Depth:	5"
Cut Direction:	Down
Weight:	17 lbs. (18 lbs. with guide rollers)

1. Dust Port
2. LED Overload Light
3. Guide Rollers
4. Magnesium Blade Guard
5. Water Feed System



Model #	Motor Power	Power Source
C14	15A/120V	Electric

HYDRAULIC PUMP UNITS CB18BVXL

Features & Benefits:

- 18 HP Briggs-Vanguard gas engine
- Adjustable handles
- Large wheels for easy moving
- Heavy duty frame design
- Light weight and portable
- Single lifting point
- Fully adjustable flow control
- Air-cooled

Specifications:

Hydraulic Flow:	0-10 gpm
Relief Pressure:	2850 psi
Hydraulic Tank Capacity:	5-1/2 gallons
Flow Control:	Fully adjustable
Hose:	25' x 1/2"
Quick Disconnects:	1/2"
Dimensions:	35-1/2" L x 23-1/2" W x 30" H



Model #	Description	Weight (lbs)
CB18BVXL (1/2")	18 HP Briggs-Vanguard with 1/2" x 25' hose, 0-10 gpm	350

HYDRAULIC PUMP UNITS CB21HXL

Features & Benefits:

- 20.5 HP Honda GX660 gas engine
- Heavy duty frame design
- Adjustable handles
- Single lifting point
- Large wheels for easy moving
- Fully adjustable flow control
- Water-cooled

Specifications:

Hydraulic Flow:	0 to 12 gmp
Relief Pressure:	2600 psi
Hydraulic Tank Capacity:	11 gallons
Flow Control:	Fully adjustable
Hose:	25' x 1/2" or 25' x 5/8"
Quick Disconnects:	1/2" and 3/4"
Dimensions:	48-1/2" L x 26-1/2" W x 39" H
Cooler Option Part #:	4400267
Fuel Tank Capacity:	4.4 gallons



Model #	Description	Weight (lbs)
CB21HXL (1/2")	20.5 HP Honda GX660 with 1/2" x 25' hose, 0-14 gpm	450
CB21HXL (5/8")	20.5 HP Honda GX660 with 5/8" x 25' hose, 0-14 gpm	450
	Catalytic Muffler for 20.5HP Honda, high mount right side	25
	Oil to air cooler	20
	Tool Tray Option (for Gas Models)	20

HYDRAULIC PUMP UNITS CB35BVXL

Features & Benefits:

- 35 HP Briggs-Vanguard gas engine
- Heavy duty frame design
- Adjustable handles
- Single lifting point
- Two large wheels for easy moving
- Fully adjustable flow control
- Water-cooled

Specifications:

Hydraulic Flow:	0 to 15 gpm
Relief Pressure:	3000 psi
Hydraulic Tank Capacity:	11 gallons
Flow Control:	Fully adjustable
Hose:	25' x 5/8"
Quick Disconnects:	1/2" and 3/4"
Dimensions:	49" L x 26-1/2" W x 39" H
Fuel Tank Capacity:	4.4 gallons



Model #	Description	Weight (lbs)
CB35BVXL (5/8")	35 HP Briggs-Vanguard gas engine with 5/8" x 25' hose, 0-17 gpm	596
	Oil to air cooler option for CB35BVXL	40
	Catalytic Muffler for 35HP Briggs Vanguard gas engine	20
	Tool Tray Option (for Gas Models)	20

CC6571D LIQUID COOLED WALK BEHIND SAW

Features & Benefits:

- Tier 4 Final liquid-cooled engine allows for a smoother running, longer lasting saw with higher productivity
- Diesel Power Source
- Easy to maneuver self propelled drive
- Strongest frame on the market
- Less rear weight for easy maneuvering and reduced operator fatigue
- Oil bath blade shaft comes standard
- One-hand sawing control and parking brake
- Fits through a 36" wide door frame (when guard is removed)
- Quick release blade shaft/flange and rear wheels
- Blade shaft tachometer-where it's needed-not at the engine, gives true blade speed



Saw Model #	Engine/Motor Make	Speeds	Engine/Motor Power	Blade Capacity
CC6571D-14	Kubota®	Single	71 HP	14"
CC6571D-20	Kubota®	Single	71 HP	20"
CC6571D-26	Kubota®	Single	71 HP	26"
CC6571D-30	Kubota®	Single	71 HP	30"
CC6571D-36	Kubota®	Single	71 HP	36"
CC6571D-42	Kubota®	Single	71 HP	42"
CC6571D-3-14	Kubota®	3-SPD (14"/26"/36")	71 HP	14"
CC6571D-3-20	Kubota®	3-SPD (20"/30"/42")	71 HP	20"
CC6571D-3-26	Kubota®	3-SPD (14"/26"/36")	71 HP	26"
CC6571D-3-30	Kubota®	3-SPD (20"/30"/42")	71 HP	30"
CC6571D-3-36	Kubota®	3-SPD (14"/26"/36")	71 HP	36"
CC6571D-3-42	Kubota®	3-SPD (20"/30"/42")	71 HP	42"

CC900TE ECONOMY TILE SAW

Features & Benefits:

- 10" blade capacity (5/8" arbor)
- 3-3/4" cutting depth
- 1-1/2 HP, 15amp, 115V high torque motor
- Rip cut up to 20", diagonal cut to 14"
- Plastic tray can be removed for cleaning
- Replaceable liquid cooled bearing housing
- Blade guard includes brush for additional blade cooling protection and over spray
- Includes 45° and 90° rip guide/miter block



Model #	Motor Make	Motor Power	Power Source	Blade Capacity	Product Weight (lbs)	Dimensions
CC900TE	Baldor®	1-1/2 HP	Electric	10"	98	39"L x 24"W x 24"H

CC1000T SUPER DUTY TILE SAW

Features & Benefits:

- 10" blade capacity (5/8" arbor)
- 3-3/4" cutting depth
- 1-1/2 HP, 15amp, 115V high torque motor
- Rip cut up to 24", diagonal cut to 18"
- Rigid, heavy duty steel frame
- Replaceable liquid cooled bearing housing
- Cutting tray/cart uses ball bearing wheels for smooth movement and accurate cutting
- Blade guard includes brush for additional blade cooling protection and over spray
- Includes 45° and 90° rip guide/miter block



Model #	Motor Make	Motor Power	Power Source	Blade Capacity	Weight (lbs.)	Dimensions
CC1000T	Baldor®	1-1/2 HP	Electric	10"	115	43"L x 26"W x 24"H

CC3700E ELECTRIC WALK BEHIND SAW POWERFUL MULTI-APPLICATION

Features & Benefits:

- Frame designed for higher torque from high horsepower engines
- Forward position motor for more weight at the blade and less on the operator
- Self propelled
- Single or three speed models
- Front pivot allows easy turning
- Multi-function control handle

Specifications:

Max. depth of cut w/ 14" blade: 4-1/2"
 Max. depth of cut w/ 20" blade: 7-1/2"
 Max. depth of cut w/ 26" blade: 10-1/2"
 Max. depth of cut w/ 30" blade: 11-3/4"
 Max. depth of cut w/ 36" blade: 14-3/4"
 Max. depth of cut w/ 42" blade: 17-1/4"
 Blade shaft diameter: 1-3/4"
 Arbor size: 1" with drive pin
 Blade shaft drive: 8 belt
 Blade mounting: Right or Left
 Blade raise & lower: Electro-hydraulic pump
 Transmission: Eaton Model 10
 Drive speed: 0-200 feet/min



Includes:

Electric Start, Telescoping front pointer, Hour meter, Cutting depth indicator, Frame lift, Quick disconnect blade flanges

14"-42" Blade Capacity

*Blade sold separately



CC3500 SAW JACKSHAFT DESIGN, FULL TORQUE

Features & Benefits:

- Great mid-size saw
- Easy to maneuver self propelled drive
- Engine adjustment mechanism for belt tightening and maintenance
- Strongest frame on the market
- 30% more torque with new jack

Specifications:

Max. depth of cut w/ 14" blade: 4-3/8"
 Max. depth of cut w/ 20" blade: 7-3/8"
 Max. depth of cut w/ 26" blade: 10-3/8"
 Max. depth of cut w/ 30" blade: 12-3/8"
 Blade shaft diameter: 1-3/4"
 Arbor size: 1" w/drive pin
 Blade shaft drive: 6 belt
 Blade mounting: Right or Left
 Blade raise & lower: Electro-hydraulic pump
 Transmission: Eaton Model 10
 Drive speed: 0-200 feet/min
 Air filter: 4 stage
 Fuel capacity (gas models): 6 gallons

Includes:

Telescoping front pointer, Cutting depth indicator, Quick disconnect blade flanges, Hour meter, Frame lift

CB20EXL ELECTRIC POWER UNIT 20 HP ELECTRIC MOTOR

Features & Benefits:

- Adjustable handles
- Large wheels for easy moving
- Heavy duty frame design
- Single lifting point
- Fully adjustable flow control
- Water-cooled

Specifications:

Hydraulic Flow: 0-15 gpm
 Relief Pressure: 2400 psi
 Tank Capacity: 11 gallons
 Hose: 25' x 5/8"
 Quick Disconnects: 1/2" and 3/4"
 Dimensions: 48-1/2"L x 26-1/2"W x 39"H



CB21HXL GAS POWER UNIT

20.5 HP HONDA GX660 GAS ENGINE

Features & Benefits:

- Heavy duty frame design
- Single lifting point
- Fully adjustable flow control
- Adjustable handles
- Large wheels for easy moving
- Water-cooled

Specifications:

Hydraulic Flow: 0-14 gpm
 Relief Pressure: 2600 psi
 Tank Capacity: 11 gallons
 Hose: 25' x 1/2" or 25' x 5/8"
 Quick Disconnects: 1/2" and 3/4"
 Dimensions: 48-1/2"L x 26-1/2"W x 39"H
 Cooler Option Part #: 4400267
 Fuel Tank Capacity: 4.4 gallons



CC300M MASONRY SAW



- Features & Benefits:**
- Cuts 5" deep with 14" blade
 - Powerful 2 HP electric motor
 - Includes 2 spare air filters

Model #	Motor Power	Power Source	Blade Capacity	Weight (lbs.)
CC300M	2 HP-115 Volt 15 amp	Electric	14"	85

CC500MXL2 MASONRY SAW

- Features & Benefits:**
- Stay level blade guard
 - Removable cutting head
 - Leg kit standard-folding stand optional
 - Side carrying handles
 - Replaceable conveyor cart rails
 - Includes water pump



Model #	Motor/Engine Make	Motor/Engine Power	Power Source	Blade Capacity	Weight (lbs)
CC525MXL2E1	Baldor®	2.5 HP-1PH-115/230V	Electric	14"	228
CC530MXL2E1	Baldor®	3.0 HP-1PH-230V (50hz)	Electric	14"	220
CC548MHXL2	Honda® GX160	4.8 HP, 7.6 torque (lbs.-ft.)	Gas	14"	220

CC190PRO-EE FIRST-CUT™ SAW

- Features & Benefits:**
- 14" blade capacity
 - Maximum cutting depth of 3-5/8" with 13.5" blade
 - Capable of .110" to .250" thick blades
 - Self propelled drive
 - Up-cut design to keep debris from going back in the cut

Model #	Engine Make/Model	Engine Power
CC190HXL-EE	Honda® GX630	20.8 HP, 35.6 Torque (lbs.-ft.)



CC150XL-EE FIRST-CUT™ SAW

- Features & Benefits:**
- 6" blade capacity
 - Maximum cutting depth of 1-3/16"
 - Reliable skid plate system for green concrete
 - Up-cut design to keep debris from going back in the cut
 - Blade raise/lower mechanical mechanism with spring loaded release

Model #	Engine Make/Model	Engine Power
CC148HXL-EE6	Honda® GX160	4.8 HP, 7.6 Torque (lbs.-ft.)
CC165BVXL-EE6	Briggs® Vanguard	6.5 HP
CC165LXL-EE6	Lifan® LF168F	6.5 HP



CC1800XL MEDIUM WALK BEHIND SAW

- Features & Benefits:**
- Electric start option on Honda and Briggs Vanguard models
 - Pull start backup on Briggs Vanguard models
 - Push or self propelled drive
 - Easy access to battery with heavy duty isolator switch to prevent battery drain
 - Screw feed raise and lower
 - Left or right side sawing
 - Lifting hook standard on all models
 - Self aligning blade shaft bearings



CC1200XL PORTABLE SAW

- Features & Benefits:**
- Heavy duty design, but light weight enough for two people to lift and carry
 - Cyclone air filter (Honda® models)
 - Easy to read built-in depth indicator
 - Slip-on blade guard
 - Heavy duty handles do not rattle like competitor handles
 - Left or right hand sawing
 - Single ribbed belt
 - Water tank and lifting bale (tank optional-for dust suppression)



PUSH MODELS			
Model #	Engine/Motor Make/Model	Engine/Motor Power	Power Source
CC1875E1XL-P	Baldor®	7.5 HP, 230V-1PH	Electric
CC1810E3XL-P	Baldor®	10 HP, 230V-3PH	Electric
CC1810E3XL-P	Baldor®	10 HP, 460V-3PH	Electric
CC1810E3XL-P	Baldor®	10 HP, 575V-3PH	Electric
CC1811HXL-P	Honda® GX390 Gas	11.7 HP, 19.5 Torque (lbs.-ft.)	Gas
CC1811HEXL-P	Honda® GX390 Gas	11.7 HP, 19.5 Torque (lbs.-ft.)	Gas
CC1813BXL-P	Briggs® 2100 Series	420cc, 21 Torque (lbs.-ft.)	Gas
CC1816BVXL-P	Briggs® Vanguard	16 HP	Gas
CC1818HYXL-P	Danfoss®	18 HP-15 gpm	Hydraulic
CC1818HYXL-P	Danfoss®	18 HP-20 gpm	Hydraulic
CC1818HYXL-P	Danfoss®	18 HP-25 gpm	Hydraulic
SELF-PROPELLED MODELS			
CC1875E1XL-S	Baldor®	7.5 HP, 230V-1PH	Electric
CC1810E3XL-S	Baldor®	10 HP, 230V-3PH	Electric
CC1810E3XL-S	Baldor®	10 HP, 460V-3PH	Electric
CC1810E3XL-S	Baldor®	10 HP, 575V-3PH	Electric
CC1811HXL-S	Honda® GX390 Gas	11.7 HP, 19.5 Torque (lbs.-ft.)	Gas
CC1811HEXL-S	Honda® GX390 Gas	11.7 HP, 19.5 Torque (lbs.-ft.)	Gas
CC1813BXL-S	Briggs® 2100 Series	420cc, 21 Torque (lbs.-ft.)	Gas
CC1816BVXL-S	Briggs® Vanguard	16 HP	Gas
CC1818HYXL-S	Danfoss®	18 HP-15 gpm	Hydraulic
CC1818HYXL-S	Danfoss®	18 HP-20 gpm	Hydraulic
CC1818HYXL-S	Danfoss®	18 HP-25 gpm	Hydraulic
CC1820HXL-S	Honda®GX630	20.8 HP, 35.6 Torque (lbs.-ft.)	Gas
CC1823BVXL-S	Briggs®Vanguard	23 HP	Gas

Saw Model #	Engine Make/Model	Engine/Motor Power	Power Source	Blade Capacity
CC1208HXL-14	Honda® GX270	8.5 HP, 14.1 Torque (lbs.-ft.)	Gas	14"
CC1211HXL-14	Honda® GX390	11.7 HP, 19.5 Torque (lbs.-ft.)	Gas	14"
CC1213BXL-14	Briggs® 2100	420cc, 21 Torque (lbs.-ft.)	Gas	14"
CC1208HXL-18	Honda® GX270	8.5 HP, 14.1 Torque (lbs.-ft.)	Gas	18"
CC1209LXL-18	Lifan® LF177F	9 HP	Gas	18"
CC1211HXL-18	Honda® GX390	11.7 HP, 19.5 Torque (lbs.-ft.)	Gas	18"
CC1213BXL-18	Briggs® 2100	420cc, 21 Torque (lbs.-ft.)	Gas	18"
CC1215LXL-18	Lifan® LF190F	15 HP	Gas	18"

M-1 COMPLETE CORE RIGS

Features & Benefits:

- 2-1/2" square column (mast) with black oxidized finish
- 6" wheels for easy mobility
- 4 leveling screws on the base
- Up to 14" bit capacity with one spacer block
- Slide handle allows for drilling in tight areas
- Combination base is a quick change over from vacuum to anchor base
- Dual switch/outlet control panel with amp meter (except for CB700 models with LED amp meter)
- Vacuum pump for quick mounting to flat surface without drilling an anchor hole (included with combination rig)
- Ceiling jack helps keep the rig in place as a backup for anchoring or vacuuming the base down (used with a brace piece-2 x 4 or other material)



Model #	Motor	Power	Motor RPM	Weight (lbs.)
M1C-20-CB744-V	Core Bore CB744*	25 amp	385/530/975/1340	134
M1C-20-CB700-V	Core Bore CB700*	20 amp	400/930	136
M1C-20-CB700-V2	Core Bore CB700*	20 amp	400/930	125
M1C-20-CB700-VA	Core Bore CB700 (with angle mast)	20 amp	400/930	129
M1C-20-MW4004-V	Milwaukee	20 amp	300/600	127
M1C-20-MW4096-V	Milwaukee	20 amp	450/900	127
M1C-20-MW4005-V	Milwaukee	20 amp	600/1200	127
M1C-15-MW4097-V	Milwaukee	15 amp	500/1000	127
M1C-23-DK22-V	Weka DK22	23 amp	550/1120/1680	127
M1C-23-DK22S-V	Weka DK22S	23 amp	800/1640/2430	127

M-4 MULTI-PURPOSE CORE RIGS

Features & Benefits:

- Great for the general contractor (basic drilling) or plumber (hand-held drilling), electrical or mechanical contractor
- Reversible slide handle (for use on left or right side)
- High strength, hard anodized 1-5/8" x 2" aluminum column
- Top carrying handle
- Quick release motor mount
- Carriage lock
- Leveling bolts on all model bases
- Hand-held option
- Light weight and portable
- Combo bases have angle braces for drilling up to 45°
- 4 adjustable slide bearings provide superior carriage rigidity
- Quick change over from vacuum to anchor base

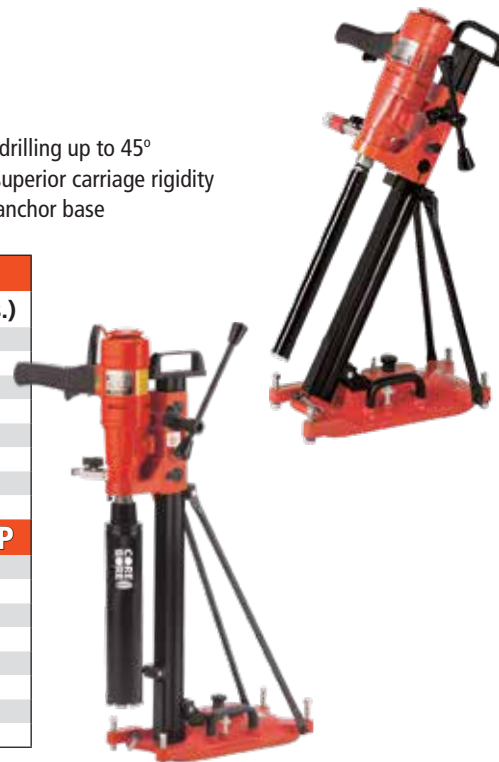

M-4 COMPLETE COMBINATION DRILL RIGS WITH VACUUM PUMP					
Model #	Motor	RPM	Part #	Cat #	Weight (lbs.)
M4C-14-DK12-V	14 Amp Weka DK12	970/2330/4400	4240001	00020	74
M4C-14-DK13-V	14 Amp Weka DK13	970/2330/4400	4240044	51033	74
M4C-19-DK16-V	19 Amp Weka DK16 (110V)	900/1900/3900	4240054	98393	74
M4C-15-MW4097-V	15 Amp Milwaukee	500/1000	4240002	01677	85
M4C-20-MW4004-V	20 Amp Milwaukee	300/600	4240004	46815	85
M4C-20-MW4096-V	20 Amp Milwaukee	450/900	4240005	01678	85
M4C-20-MW4005-V	20 Amp Milwaukee	600/1200	4240006	01679	85
M4C-7-DK12-V	7 Amp Weka DK12 (230V)	970/2330/4400	4240009	60114	74
M-4 COMPLETE COMBINATION DRILL RIGS WITHOUT VACUUM PUMP					
M4C-14-DK12	14 Amp Weka DK12	970/2330/4400	4240046	66489	67
M4C-14-DK13	14 Amp Weka DK13	970/2330/4400	4240047	66975	67
M4C-19-DK16	19 Amp Weka DK16 (110V)	900/1900/3900	4240057	08871	67
M4C-15-MW4097	15 Amp Milwaukee	500/1000	4240048	68601	68
M4C-20-MW4004	20 Amp Milwaukee	300/600	4240050	89951	68
M4C-20-MW4096	20 Amp Milwaukee	450/900	4240051	72631	68
M4C-20-MW4005	20 Amp Milwaukee	600/1200	4240052	76402	68
M4C-7-DK12	7 Amp Weka DK12 (230V)	970/2330/4400	4240053	10169	66

WEKA® DK12

Features & Benefits:

- Thermal overload protection switch
- Side handle for stability
- Water connection for wet coring only
- 5/8"-11 or 1.250"-7 spindle
- Three speed for bits up to 3" (6" mounted)
- Includes carrying case and wrench
- Two leveling bubbles for accurate coring
- Can be used on M-3 & M-4
- **Includes:** Plastic molded carrying case, side handle, 1/2" BSP male to 5/8-11 male adapter, wrench

Motor/Model #	AMP	No Load RPM	Loaded RPM	Weight(lbs.)
WEKA DK12*-Wet only	14	970/2330/4400	580/1400/2900	25
WEKA DK12*-Wet only	7 (230V)	970/2330/4400	580/1400/2900	25



M-2 HEAVY DUTY CORE RIGS

Features & Benefits:

- Heavy duty rig for larger jobs and the professional driller
- Dual switch/outlet control panel with amp meter (except for CB700 models with LED amp meter)
- 2-7/8" precision made, chrome plated square column (mast)
- Vacuum pump for quick mounting to flat surface without drilling an anchor hole (Included with combination rig)
- Combo base is a quick change over from vacuum to anchor base
- 6" wheels for easy mobility with 4 Leveling Screws on base
- Larger mast to withstand high torque and large diameter bits
- The 4-spoke handle allows the operator to easily apply feed pressure
- Optional roller carriage allows for more precise drilling



Autofeed option available

COMPLETE M-2 COMBINATION DRILL RIGS WITH VACUUM PUMP

Model #	Motor Make/Model	Power	Motor RPM	Part #	Cat #	Weight (lbs.)
M2C-20-CB744-V	Core Bore CB744*	25 amp	385/530/975/1340	4245107	81057	135
M2C-20-CB700-V	Core Bore CB700*	20 amp	400/930	4241164	30117	135
M2C-20-MW4004-V	Milwaukee 4004	20 amp	300/600	4241048	01694	139
M2C-20-MW4096-V	Milwaukee 4096	20 amp	450/900	4241059	01704	139
M2C-20-MW4005-V	Milwaukee 4005	20 amp	600/1200	4241049	01695	139
M2C-15-MW4097-V	Milwaukee 4097	15 amp	500/1000	4241051	59573	139
M2C-23-DK22-V	Weka DK22	23 amp	550/1120/1680	4241068	47426	137
M2C-23-DK22S-V	Weka DK22S	23 amp	800/1640/2430	4241069	50007	137

COMPLETE M-2 COMBINATION DRILL RIGS WITHOUT VACUUM PUMP

M2C-20-CB744	Core Bore CB744*	25 amp	385/530/975/1340	4245105	81061	122
M2C-20-CB700	Core Bore CB700*	20 amp	400/930	4241166	30152	122
M2C-20-MW4004	Milwaukee 4004	20 amp	300/600	4241083	76314	124
M2C-20-MW4096	Milwaukee 4096	20 amp	450/900	4241084	75479	124
M2C-20-MW4005	Milwaukee 4005	20 amp	600/1200	4241085	69558	124
M2C-15-MW4097	Milwaukee 4097	15 amp	500/1000	4241086	76984	124
M2C-23-DK22	Weka DK22	23 amp	550/1120/1680	4241088	73291	120
M2C-23-DK22S	Weka DK22S	23 amp	800/1640/2430	4241089	75275	120

COMPLETE M-2 ANCHOR DRILL RIGS

M2A-20-CB744	Core Bore CB744*	25 amp	385/530/975/1340	4245106	81062	110
M2A-20-CB700	Core Bore CB700*	20 amp	400/930	4241163	30098	110
M2A-20-MW4004	Milwaukee 4004	20 amp	300/600	4241009	01692	114
M2A-20-MW4096	Milwaukee 4096	20 amp	450/900	4241003	01687	114
M2A-20-MW4005	Milwaukee 4005	20 amp	600/1200	4241010	01693	114
M2A-15-MW4097	Milwaukee 4097	15 amp	500/1000	4241006	01689	114
M2A-23-DK22	Weka DK22	23 amp	550/1120/1680	4241008	01691	114
M2A-23-DK22S	Weka DK22S	23 amp	800/1640/2430	4241011	52247	114



M-5 PRO HEAVY DUTY Q.D. CORE RIGS

Features & Benefits:

- Quick disconnect motor mount that makes it easy to remove the motor
- 4-spoke handle (can be used on right or left) on combo rig
- Positive carriage lock and friction lock
- Extruded aluminum light weight column (mast) that has a reinforced track with steel roller guide and rollers
- Dual control panel/amp meter included with combination rigs
- Quick release vacuum button
- Convenient carrying handle
- Level bubble on column
- 2 gear ratios for easy carriage feed
- Angle stand to drill up to 45°

M-5 PRO Combination Drill Rigs With Vacuum Pump		
Model #	Motor/Description	Weight (lbs)
M5PC-CB744-110V	CB744, 25 Amp (110V) M-5 PRO Combo Rig without Vacuum Pump	128
M5PC-DK22-110V	Weka DK22F, 23 Amp (110V) M-5 PRO Combo Rig with Vacuum Pump	118
M5PC-DK22-230V	Weka DK22F, 11 Amp (230V) M-5 PRO Combo Rig with Vacuum Pump	118
M5PC-DK32-110V	Weka DK32F, 30 Amp (110V) M-5 PRO Combo Rig with Vacuum Pump	119
M5PC-DK32-230V	Weka DK32F, 15 Amp (230V) M-5 PRO Combo Rig with Vacuum Pump	119
M-5 PRO Combination Drill Rigs Without Vacuum Pump		
M5PC-CB744-110	CB744, 25 Amp (110V) M-5 PRO Combo Rig without Vacuum Pump	124
M5PC-DK22-110	Weka DK22F, 23 Amp (110V) M-5 PRO Combo Rig without Vacuum Pump	118
M5PC-DK22-230	Weka DK22F, 11 Amp (230V) M-5 PRO Combo Rig without Vacuum Pump	118
M5PC-DK32-110	Weka DK32F, 30 Amp (110V) M-5 PRO Combo Rig without Vacuum Pump	119
M5PC-DK32-230	Weka DK32F, 15 Amp (230V) M-5 PRO Combo Rig without Vacuum Pump	119
M-5 PRO Anchor Drill Rigs		
M5PA-CB744-110	CB744, 25 Amp (110V) M-5 PRO Anchor Drill Rig	104
M5PA-DK22-110	Weka DK22F, 23 Amp (110V) M-5 PRO Anchor Drill Rig	92
M5PA-DK22-230	Weka DK22F, 11 Amp (230V) M-5 PRO Anchor Drill Rig	92
M5PA-DK32-110	Weka DK32F, 30 Amp (110V) M-5 PRO Anchor Drill Rig	94
M5PA-DK32-230	Weka DK32F, 15 Amp (230V) M-5 PRO Anchor Drill Rig	94
M-5 PRO Accessories		
M5PA-SO	M-5 PRO Anchor Drill Stand Only (39" LONG MAST)	65
M5PC-SO	M-5 PRO Combo Drill Stand Only (39" mast)	72
M5P-QD	M-5 PRO Quick Disconnect Motor Mount Assembly	5
M5P-QDO-7	M-5 PRO Quick Disconnect Outrigger Assy (Add 7" of drilling diameter)	10
M5P-QDO-10	M-5 PRO Quick Disconnect Outrigger Assy (Add 10" of drilling diameter)	10

TYROLIT PREMIUM HIGH SPEED GAS & ELECTRIC SAW WHEELS FOR STEEL-TYPE 1

- Premium aluminum oxide grain
- When increased productivity is required in cutting all ferrous metals, structural steels, rebar and metal decking.
- Good for rail cutting applications
- Superior cut rate and wheel life

SIZE	Specification	Max RPM	Unit Pkg. Qty.
12" x 1/8" x 1"	A30P/100	5100	10
12" x 1/8" x 20mm	A30P/100	5100	10
14" x 1/8" x 1"	A30P/100	4400	10
14" x 1/8" x 20mm	A30P/100	4400	10



TYROLIT PREMIUM ULTRA-THIN 2-IN-1 WHEELS FOR STEEL & STAINLESS STEEL-NEXT GENERATION -TYPE 1

- Two applications with one wheel; excellent performance in both stainless and carbon steel.
- Significant increase in wheel life and cutting ability
- Short cutting time, extremely free cutting, rough side-surfaces
- Improved first-cut behavior offering free cutting from the start
- Superior wear out behavior with stable cutting ability over entire diameter
- Less noise and vibration
- Perfect exploitation of raw material leaving 30% less cutting dust.
- Forgiving flexibility

SIZE	Specification	Max RPM	Material #	Cat #	Unit Pkg. Qty.
4-1/2" x .040 x 7/8"	A60Q-BFKA	13280	773268	44900	25
5" x .040 x 7/8"	A60Q-BFKA	12220	773269	44902	25



TYROLIT BASIC WHEELS FOR GENERAL PURPOSE USE STEEL-TYPE 27

- Aluminum oxide grain
- General purpose cutting/light grinding wheels for steel
- Good cut rate and wheel life
- For all cross sections

SIZE	Specification	Max Safe RPM	Material #	Unit Pkg. Qty.
7" x 1/8" x 7/8"	A30BF	8600	20006672	25
7" x 1/8" x 5/8"-11	A30BF	8600	20006673	10



STONE FABRICATION BLADES

SECTION K



SIGNATURE SERIES

BRIDGE SAW BLADES



WDS WHITE LIGHTNING Granite

Item#	Diameter Inches /mm	Seg Specs L x W x H	Arbor
SGX14-EDIA	14/350	40 x 3.2 x 20	60-50mm
SGX16-EDIA	16/400	40 x 3.4 x 20	60-50mm
SGX18-EDIA	18/450	40 x 3.8 x 20	60-50mm

WDS RAZOR Granite

Item#	Diameter Inches /mm	Seg Specs L x W x H	Arbor
SGSP14-C	14 / 350	40 x 3.2 x 10	60-50mm
SGSP16-C	16 / 400	40 x 3.4 x 10	60-50mm
SGSP18-C	18 / 450	40 x 3.8 x 10	60-50mm
SGSP20-C	20 / 500	40 x 3.8 x 10	60-50mm



WDS VOLCANO EXPRESS Granite

Item#	Diameter Inches /mm	Seg Specs L x W x H	Arbor
SGVX14-1	14 / 350	40 x 3.2 x 20	60-50mm
SGVX16-1	16 / 400	40 x 3.4 x 20	60-50mm
SGVX18-1	18 / 550	40 x 3.8 x 20	60-50mm



WDS VOLCANO Granite

Item#	Diameter Inches /mm	Seg Specs L x W x H	Arbor
SSGXT12-1	12 / 300	40 x 3.0 x 20	60-50mm
SSGXT14-1	14 / 350	40 x 3.2 x 20	60-50mm
SSGXT16-1	16 / 400	40 x 3.4 x 20	60-50mm
SSGXT18-1	18 / 450	40 x 3.8 x 20	60-50mm

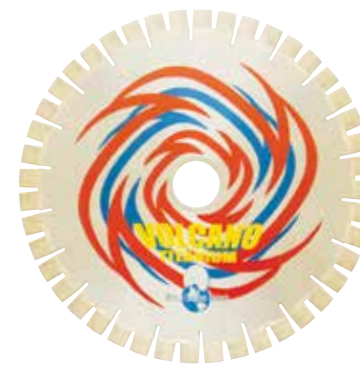

EDIA (EVOLUTION OF DIAMOND IMPREGNATION ARRAY)

These days the trend in diamond tools is an application of an automatic array system. An automatic array system changes our stereotype that life time is in inverse proportion to cutting speed. So our company has devised an automatic array system through many years of R & D and millions of dollars invested. We let this system distribute and arrange diamond particle, so that the system has the best efficiency in cutting mechanism.

We named this system "EDIA" (Evolution of Diamond Impregnation Array). The system is already proven through many field tests and guaranteed more than 30% improvement of cutting speed, also the blade life can be extended by more than 50%.

Evolution
Diamond
Impregnation
Array

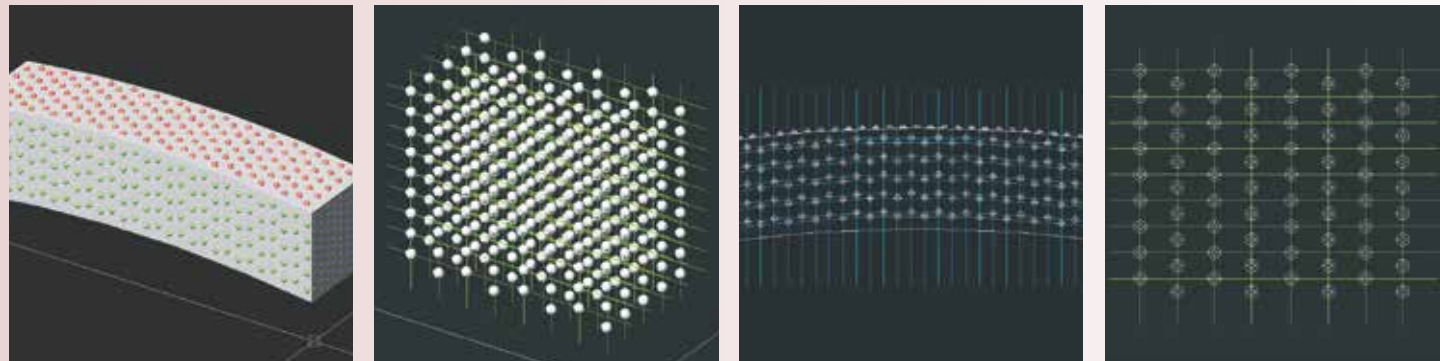
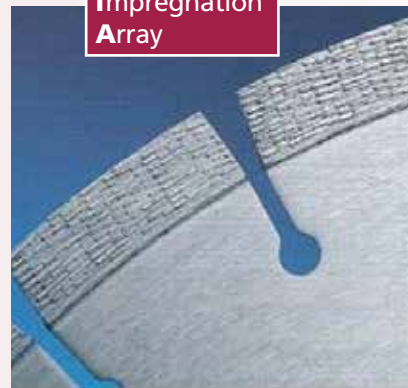

WDS MILLING WHEELS

TEFLON CORE

Item#	Diameter Inches /mm	Seg Thickness Inches / mm	Arbor
MLT14-112	14 / 350	1 1/2 / 38	60-50mm
MLT16-112	16 / 400	1 1/2 / 38	60-50mm



WDS EXCALIBUR Marble

Item#	Diameter Inches /mm	Seg Specs L x W x H	Arbor
SMS14-C	14/350	40 x 3.2 x 7	60-50mm
SMS16-C	16/400	40 x 3.4 x 7	60-50mm
SMS18-C	18/450	40 x 3.8 x 7	60-50mm
SMS20-C	20/500	40 x 3.8 x 7	60-50mm



WET POLISHING PADS

WDS 4"/ 100MM PRO SERIES



For Engineered Stone – 3mm Velcro Backed – Flexible

Item #	Grit
PPES4/100	50
PPES4/100	100
PPES4/200	200
PPES4/400	400
PPES4/800	800
PPES4/1500	1500
PPES4/3000	3000
PPES4/BUFF	Buff

WDS 4"/ 100MM ULTRA - PIRANHA WET POLISHING PAD



For Stone – 4mm – Wet Polishing
Provides amazing results on tough applications, including high luster finishes on dark granites.

Item #	Grit
PWP4-50	50
PWP4-100	100
PWP4-200	200
PWP4-400	400
PWP4-800	800
PWP4-1500	1500
PWP4-3000	3000

WDS 4"/ 100MM SUPER-HEX PRO WET/DRY POLISHING PAD



For Stone – 3mm – Wet Polishing
True general purpose fabrication pad for all dark and light granites, marbles, engineered stones, and even Dekton®
Unique rased hexagon patterns allows the flow of air and water to reduce heat and slurry build-up.

Item #	Grit
OPP4-50	50
OPP4-100	100
OPP4-200	200
OPP4-400	400
OPP4-800	800
OPP4-1500	1500
OPP4-3000	3000

WET POLISHING PADS

WDS 3"/ 75MM FPS PRO SERIES



For Granite – 3mm Velcro Backed – Extra Flexible

Item #	Grit	Color
FP3/50-7B	50	Brown
FP3/80-7B	80	Aqua
FP3/150-7B	150	Red
FP3/300-7B	300	Orange
FP3/500-7B	500	Yellow
FP3/1000-7B	1000	Green
FP3/2000-7B	2000	Blue
FP3/3000-7B	3000	Dark Blue
PPFBW3-7B	Buff / W	White
PPFBB3-7B	Buff / B	Black

WDS 4"/ 100MM FPS PRO SERIES



For Granite – 3mm Velcro Backed – Extra Flexible

Item #	Grit	Color
FP4/50-7B	50	Brown
FP4/80-7B	80	Aqua
FP4/150-7B	150	Red
FP4/300-7B	300	Orange
FP4/500-7B	500	Yellow
FP4/1000-7B	1000	Green
FP4/2000-7B	2000	Blue
FP4/3000-7B	3000	Dark Blue
PPFBW4-7B	Buff / W	White
PPFBB4-7B	Buff / B	Black

WDS 5"/ 125MM FPS PRO SERIES



For Granite – 3mm Velcro Backed – Extra Flexible

Item #	Grit	Color
FP5/50-7B	50	Brown
FP5/80-7B	80	Aqua
FP5/150-7B	150	Red
FP5/300-7B	300	Orange
FP5/500-7B	500	Yellow
FP5/1000-7B	1000	Green
FP5/2000-7B	2000	Blue
FP5/3000-7B	3000	Dark Blue
PPFBW5-7B	Buff / W	White
PPFBB5-7B	Buff / B	Black

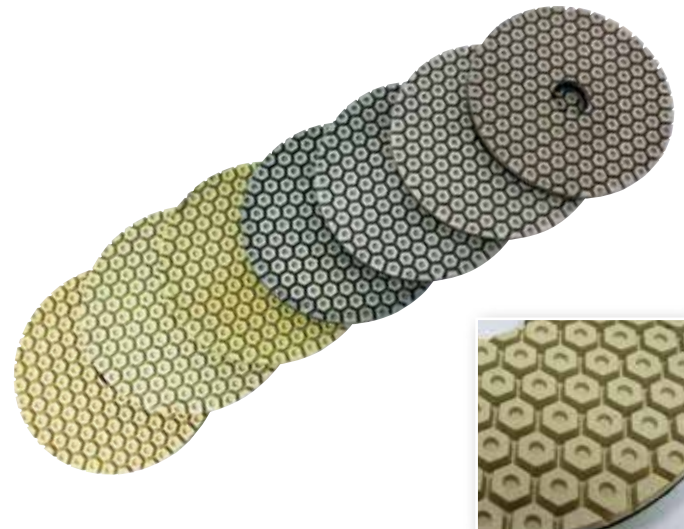
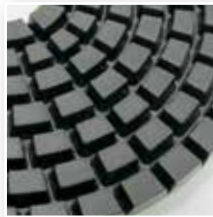
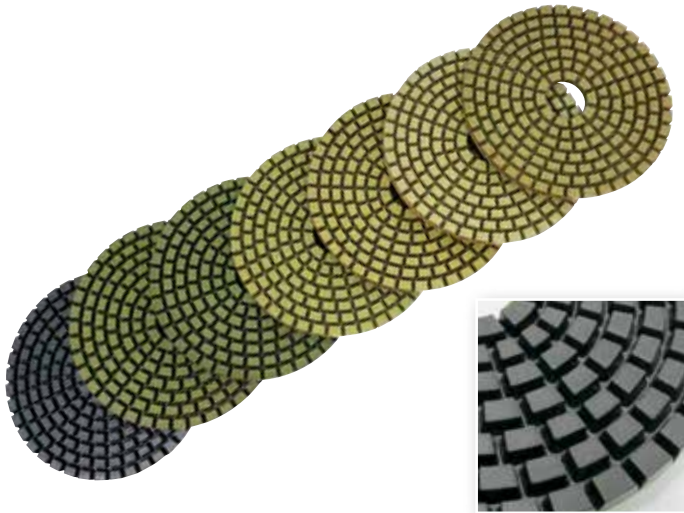
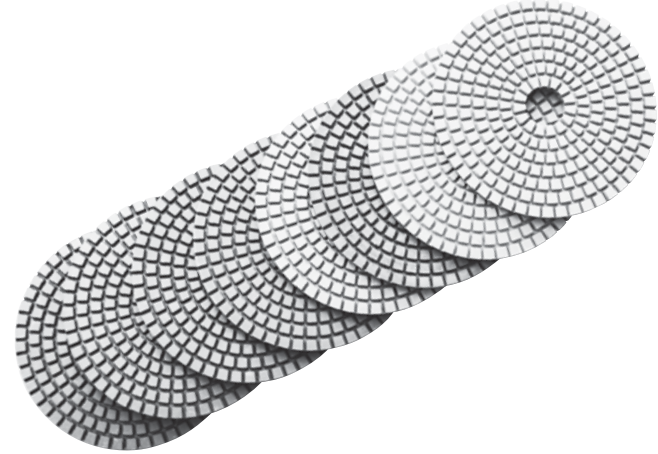

WET POLISHING PADS



WDS 3"/ 75MM PP PREMIUM SERIES

For Granite – 3mm Velcro Backed – Extra Flexible

Item #	Grit
PP3/50-7B	50
PP3/100-7B	100
PP3/200-7B	200
PP3/400-7B	400
PP3/800-7B	800
PP3/1500-7B	1500
PP3/3000-7B	3000
PP3/8500-7B	8500

WDS 4"/ 100MM PP PREMIUM SERIES

For Granite – 3mm Velcro Backed – Extra Flexible

Item #	Grit
PP4/50-7B	50
PP4/100-7B	100
PP4/200-7B	200
PP4/400-7B	400
PP4/800-7B	800
PP4/1500-7B	1500
PP4/3000-7B	3000
PP4/8500-7B	8500

WDS 5"/ 125MM PP PREMIUM SERIES

For Granite – 3mm Velcro Backed – Extra Flexible

Item #	Grit
PP5/50-7B	50
PP5/100-7B	100
PP5/200-7B	200
PP5/400-7B	400
PP5/800-7B	800
PP5/1500-7B	1500
PP5/3000-7B	3000
PP5/8500-7B	8500



WET POLISHING PADS

WDS 3"/ 75MM VEXPRO CONVEX

Wet Polishing – Velcro Backed

Item #	Grit
CPP3-50	50
CPP3-100	100
CPP3-200	200
CPP3-400	400
CPP3-800	800
CPP3-1500	1500
CPP3-3000	3000
CPP3-BUFF/W	Buff
CPP3-BUFF/B	Buff



WDS 4"/ 100MM VEXPRO CONVEX

Wet Polishing – Velcro Backed

Item #	Grit
CPP4-50	50
CPP4-100	100
CPP4-200	200
CPP4-400	400
CPP4-800	800
CPP4-1500	1500
CPP4-3000	3000
CPP4-BUFF/W	Buff
CPP4-BUFF/B	Buff



WDS 4"/ 100MM SUNNY

For Stone – 3mm – Wet Polishing – Resin with Copper Bond – Velcro Backed

Item #	Grit
PS4-30	30
PS4-50	50
PS4-100	100
PS4-200	200
PS4-400	400
PS4-800	800
PS4-1500	1500
PS4-3000	3000



WDS 4"/ 100MM COPPER BOND METAL

Flexible – For Stone – Wet Polishing – Velcro Backed 4" x 3mm Sunny Pads

Item #	Grit
PPS4-30	30
PPS4-50	50
PPS4-100	100
PPS4-200	200
PPS4-400	400
PPS4-800	800
PPS4-1500	1500
PPS4-1500	3000

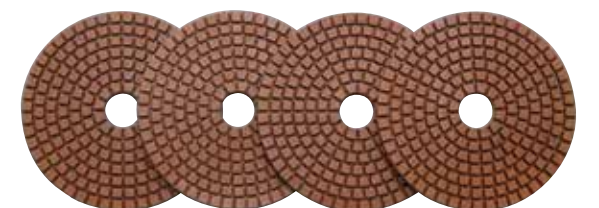

WET POLISHING PADS

WDS PRO SERIES HEXAGON TYPE

For Stone – Flexible – Dry or Wet Polishing – Velcro Backed



Item #	Grit
DPHW4-50	50
DPHW4-100	100
DPHW4-200	200
DPHW4-400	400
DPHW4-800	800
DPHW4-1500	1500
DPHW4-3000	3000
DPHW4-BUFF/W	Buff / W
DPHW4-BUFF	Buff / B
DPHW5-50	50
DPHW5-100	100
DPHW5-200	200
DPHW5-400	400
DPHW5-800	800
DPHW5-1500	1500
DPHW5-3000	3000
DPHW7-200	200
DPHW7-400	400
DPHW7-800	800
DPHW7-1500	1500
DPHW7-3000	3000

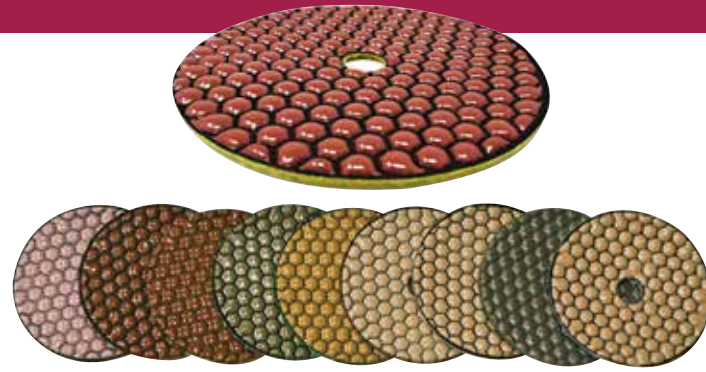

WDS HEXAGON TYPE EC SERIES

Flexible – Dry or Wet Polishing – Velcro Backed

Item #	Grit
DPHEC4-50	50
DPHEC4-100	100
DPHEC4-200	200
DPHEC4-400	400
DPHEC4-800	800
DPHEC4-1500	1500
DPHEC4-3000	3000
DPHEC4-BUFF/W	Buff / W
DPHEC4-BUFF/B	Buff / B
DPHEC5-50	50
DPHEC5-100	100
DPHEC5-200	200
DPHEC5-400	400
DPHEC5-800	800
DPHEC5-1500	1500
DPHEC5-3000	3000
DPHEC5 - BUFF/W	Buff
DPHEC5-BUFF/B	Buff

HAND PADS

WDS GRANITE POLISHING HAND PADS

Item#	Grit	Diameter Inches /mm
HP-60	50	4 x 2.5 / 100 x 65
HP-100	100	4 x 2.5 / 100 x 65
HP-200	200	4 x 2.5 / 100 x 65
HP-400	400	4 x 2.5 / 100 x 65
HP-800	800	4 x 2.5 / 100 x 65
HP-1500	1500	4 x 2.5 / 100 x 65
HP-3000	3000	4 x 2.5 / 100 x 65



BACKING PADS

ALUMINUM BACKER PADS

For Flat Polishing with Velcro Backing – 5/8" - 11 Thread Mount

Item#	Diameter Inches /mm
BPA5	5 / 125
BPA7	7 / 180



HARD RUBBER BACKER PADS

For Flat Polishing with Velcro Backing – 5/8" - 11 Thread Mount

Item#	Diameter Inches /mm
BP3	3 / 76
BP4	4 / 100
BP5	5 / 125
BP7	7 / 180



FLEXIBLE RUBBER BACKER PADS

For All Polishing with Velcro Backing – 5/8" - 11 Thread Mount

Item#	Diameter Inches /mm
BP3-F	3 / 76
BP4-F	4 / 100
BP5-F	5 / 125
BP7-F	7 / 180



GREEN FLEXIBLE RUBBER BACKER PADS

For All Polishing - Extremely flexible with Velcro Backing - 5/8" - 11 Thread Mount

Item#	Diameter Inches /mm
GBP-5	5 / 125



SUPER FLEXIBLE RUBBER BACKER PADS

For All Polishing - thin and flexible with Velcro Backing – 5/8" - 11 Thread Mount

Item#	Diameter Inches /mm
BP5-XFLEX	5 / 125



COREBITS FOR GRINDERS



WDS PRO SERIES



For Granite / Stone / Tile – 5/8" - 11 Threads

Item#	Diameter Inches /mm
DGBT-1	1" Dry Granite Bit W/ Side Protection
DGBT-112	1 1/2" Dry Granite Bit W/ Side Protection
DGBT-114	1 1/4" Dry Granite Bit W/ Side Protection
DGBT-134	1 3/4" Dry Granite Bit W/ Side Protection
DGBT-138	1 3/8" Dry Granite Bit W/ Side Protection
DGBT-2	2" Dry Granite Bit W/ Side Protection

PRO SERIES VACUUM BRAZED COREBITS

For Granite / Stone / Tile – Wet & Dry Use – 5/8" - 11 Threads

Item#	Diameter Inches /mm	Item#	Diameter Inches /mm
VBCBT-14	1/4 / 6	VBCBT-114	1 1/4 / 32
VBCBT-38	3/8 / 10	VBCBT-138	1 3/8 / 35
VBCBT-12	1/2 / 13	VBCBT-112	1 1/2 / 38
VBCBT-34	3/4 / 19	VBCBT-158	1 5/8 / 41
VBCBT-1	1 / 25	VBCBT-134	1 3/4 / 45
VBCBT-118	1 1/8 / 28	VBCBT-2	2 / 50



WDS PRO SERIES CROWN COREBITS

For Granite – Wet Use
5/8" - 11 Threads

Item#	Diameter Inches /mm
GBCTT-12	1/2 / 13
GBCTT-34	3/4 / 19
GBCTT-1	1 / 25
GBCTT-118	1 1/8 / 28
GBCTT-114	1 1/4 / 32
GBCTT-138	1 3/8 / 35
GBCTT-112	1 1/2 / 38



WDS PRO SEGMENTED COREBITS

For Granite – Wet Use
5/8" - 11 Threads – Laser Welded

Item#	Diameter Inches /mm
GBSTT-1	1 / 25
GBSTT-118	1 1/8 / 28
GBSTT-114	1 1/4 / 32
GBSTT-138	1 3/8 / 35
GBSTT-112	1 1/2 / 38
GBSTT-134	1 3/4 / 45
GBSTT-2	2 / 50
GBSTT-214	1 1/4 / 57
GBSTT-212	2 1/2 / 63
GBSTT-3	3 / 76
GBSTT-312	3 1/2 / 89
GBSTT-4	4 / 100
GBSTT-412	4 1/2 / 57



WDS PRO SERIES SEGMENTED COREBITS

For Granite – Dry or Wet Use –
1/2" Shank – Laser Welded

Item#	Diameter Inches /mm
GBST-1	1 / 25
GBST-118	1 1/8 / 28
GBST-114	1 1/8 / 32
GBST-138	1 3/8 / 35
GBST-112	1 1/2 / 38

NON-CORING BITS

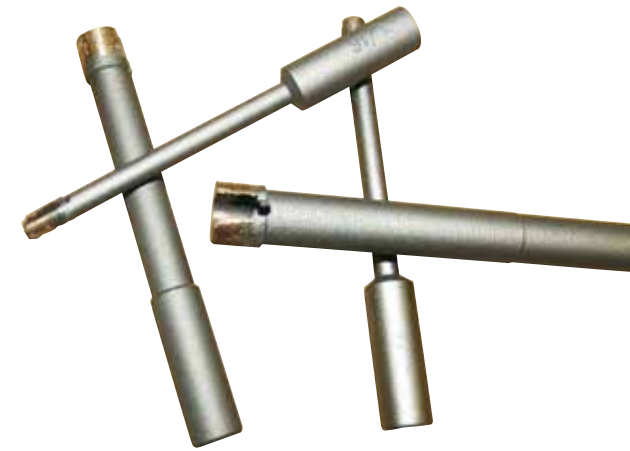

PREMIUM NON-CORING BITS

For Granite – Wet Use – 3/8" Shank

Item#	Diameter Inches /mm
PB-36	3/16
PB-14	1/4
PB-38	3/8
PB-12	1/2



WDS PRO SERIES NON-CORING BITS

For Granite – Wet Use – 5/8" - 11 Threads

Item#	Diameter Inches /mm
NCBT-14	1/4 / 6.35
NCBT-38	3/8 / 9.52
NCBT-12	1/2 / 12.7

CORE BITS FOR HAND HELD DRILLS

WDS PRO SERIES TURBO COREBITS

For Granite / Marble / Tile – Dry or Wet Use
3/8" Shank with Removable Pilot Bit

Item#	Diameter Inches /mm
TB12-7B	1/2 / 13
TB58-7B	5/8 / 16
TB34-7B	3/4 / 19
TB78-7B	7/8 / 22
TB1-7B	1 / 25
TB118-7B	1 1/8 / 28
TB114-7B	1 1/4 / 32
TB138-7B	1 3/8 / 35

Item#	Diameter Inches /mm
TB112-7B	1 1/2 / 38
TB134-7B	1 3/4 / 45
TB178-7B	1 7/8 / 48
TB2-7B	2 / 50
TB214-7B	2 1/4 / 50
TB238-7B	2 3/8 / 59
TB212-7B	2 1/2 / 64

Item#	Diameter Inches /mm
TB258-7B	2 5/8 / 67
TB234-7B	2 3/4 / 70
TB278-7B	2 7/8 / 73
TB3-7B	3 / 76
TB314-7B	3 1/4 / 83
TB338-7B	3 3/8 / 86
TB312-7B	3 1/2 / 89

Item#	Diameter Inches /mm
TB358-7B	3 5/8 / 92
TB4-7B	4 / 102
TB414-7B	4 1/4 / 108
TB412-7B	4 1/5 / 114
TB5-7B	5 / 127
TB512-7B	5 1/2 / 140
TB7-7B	7 / 178



CURVE CUTTING BLADES



WDS PRO SERIES SEGMENTED CONCAVE

Dry or Wet Use – Laser Welded

Item#	Diameter Inches /mm
CS4.5-7B	4 1/2 / 115
CS5-7B	5 / 125



WDS PRO SERIES SEGMENTED CONCAVE WITH SIDE PROTECTION

Dry or Wet Use – Laser Welded

Item#	Diameter Inches /mm
CX5-H	5 / 125



WDS PRO TURBO CONCAVE WITH SIDE PROTECTION

Dry or Wet Use

Item#	Diameter Inches /mm
TCX5-H	5 / 125

ELECTRO PLATED CUTTING BLADES

WDS PRO SERIES SEGMENTED

For Marble – Dry or Wet Use – Long Life

Item#	Diameter Inches /mm
E4-1	4 / 100
E4.5-1	4 1/2 / 115
E5-1	5 / 125
E7-1	7 / 180



WDS PRO SERIES U-SLOT

For Marble – Dry or Wet Use – Fast Cut

Item#	Diameter Inches /mm
EPV4-1	4 / 100
EPV4.5-1	4 1/2 / 115
EPV5-1	5 / 125
EPV7-1	7 / 180



FINGER BITS

ZERO TOLERANCE DRUM WHEELS

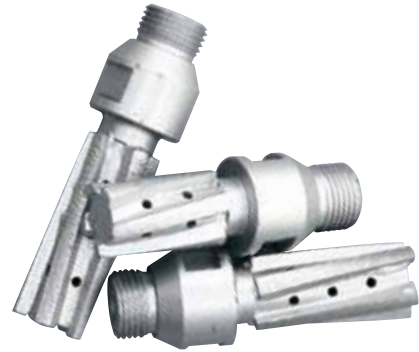

WDS PRO SERIES SEGMENTED

1/2" Gas Connection Segmented Finger Bits – Wet Use
For Granite & Engineered Stone

Item #	Diameter Inches /mm	Diamond Length mm
FBS-1-40	1 / 25	40
FBS-1-50	1 / 25	50
FBS-1-60	1 / 25	60



WDS PRO SERIES VACUUM BRAZED

1/2" Gas Connection – Dry or Wet Use – For Granite & All Stone

Item #	Diameter Inches /mm	Diamond Length mm
FRVB-1-40	1 / 25	40
FRVB-1-50	1 / 25	50
FRVB-1-60	1 / 25	60



WDS PRO SERIES WIZARD BITS

1/2" Gas Connection – Wet Use – M12 Threads – 2" Length
For Granite & All Stone On CNC & Radial Arm Machines

Item #	Diameter
WB-20-H	20mm
WBA	M12 - 1/2" GAS ADAPTOR

WDS PRO SERIES SEGMENTED

Dry or Wet Use – 5/8" - 11 Threads

Item #	Diameter Inches /mm
ZTCW2-H	2 / 50
ZTCW3-H	3 / 75
ZTCW4-H	4 / 100

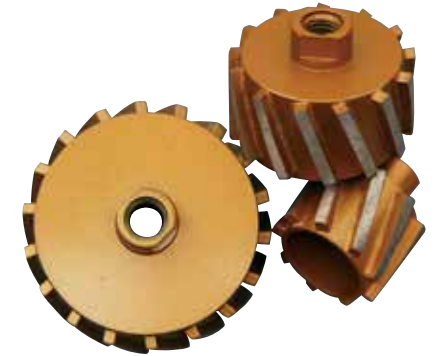

WDS PRO SERIES RESIN FILLED

Dry or Wet Use – 5/8" - 11 Threads

Item #	Diameter Inches /mm
RFZTW-2	2 / 50
RFZTW-3	3 / 75
RFZTW-4	4 / 100



WDS PRO SERIES SINTERED

Wet Use – 5/8" - 11 Threads – For Granite

Item #	Diameter Inches /mm	Grit
DW2-30	2 / 50	30
DW2-50	2 / 50	50
DW2-120	2 / 50	120
DW2-200	2 / 50	200



WDS PRO SERIES VACUUM BRAZED

Wet or Dry Use – 5/8" - 11 Threads

Item #	Diameter Inches /mm	Grit
VBDWZ-M	2 / 50	Medium
VBDWZ-C	2 / 50	Coarse



CUP WHEELS FOR GRINDERS



WDS PRO SERIES TURBO STYLE



Wet or Dry Use – For Granite

Item #	Diameter Inches /mm	Grit	Arbor
4" Threaded - Coarse			TCWCT4-5Q
4" Threaded - Medium			TCWMT4-5Q
4" Threaded - Fine			TCWFT4-5Q
5" Threaded - Coarse			TCWCT5-5Q
5" Threaded - Medium			TCWMT5-5Q
5" Threaded - Fine			TCWFT5-5Q
7" Threaded - Coarse			TCWCT7-5Q
7" Threaded - Medium			TCWMT7-5Q
7" Threaded - Fine			TCWFT7-5Q

WDS PRO SERIES TURBO STYLE ALUMINUM BACK



For Granite - Wet or Dry Use – 5/8" - 11 Threads

Item #	Diameter Inches	Grit
TCWFT4-1	4" x 5/8" 11 Threads	Fine
TCWMT4-1	4" x 5/8" 11 Threads	Medium
TCWCT4-1	4" x 5/8" 11 Threads	Coarse
TCWFT5-1	5" x 5/8" 11 Threads	Fine
TCWF5-1	5" x 5/8" - 7/8" Non-Thread	Fine
TCWMT5-1	5" x 5/8" 11 Threads	Medium
TCWM5-1	5" x 5/8" - 7/8" Non-Thread	Medium
TCWCT5-1	5" x 5/8" 11 Threads	Coarse
TCWC5-1	5" x 5/8" - 7/8" Non-Thread	Coarse
TCWCT6-1	6" x 5/8" 11 Threads	Coarse
TCWFT7-1	7" x 5/8" 11 Threads	Fine
TCWF7-1	7" x 5/8" - 7/8" Non-Thread	Fine
TCWMT7-1	7" x 5/8" 11 Threads	Medium
TCWM7-1	7" x 5/8" - 7/8" Non-Thread	Medium
TCWCT7-1	7" x 5/8" 11 Threads	Coarse
TCWC7-1	7" x 5/8" - 7/8" Non-Thread	Coarse

WDS PRO SERIES CONVEX TURBO STYLE ALUMINUM BACK



For Granite & All Other Stones – Wet or Dry Use – 5/8" - 11 Threads

Item #	Diameter Inches /mm	Grit
CTCWCT4-1	4 / 100	Coarse
CTCWMT4-1	4 / 100	Medium



CUP WHEELS FOR GRINDERS

WDS PRO SERIES RESIN FILLED



For Granite – Wet or Dry Use – 5/8" - 11 Threads

Item #	Diameter Inches /mm	Grit
RCWFT4-5Q	4 / 100	Fine
RCWMT4-5Q	4 / 100	Medium
RCWCT4-5Q	4 / 100	Coarse



4" FLAT VACUUM BRAZED WHEEL



For Stones - Wet or Dry Use – 5/8" - 11 Threads

Item #	Diameter Inches /mm	Grit
VBFWTC4-1	4 x 5/8 x 11	Course 30/40
VBFWTM4-1	4 x 5/8 x 11	Medium 50/60
VBFWTF4-1	4 x 5/8 x 11	Fine 80/100
VBFWTC7-1	7 x 5/8 x 11	Course 30/40
VBFWTM7-1	7 x 5/8 x 11	Medium 50/60
VBFWTF7-1	7 x 5/8 x 11	Fine 80/100



4" CONVEX VACUUM BRAZED WHEEL



For Granite & All Other Stones – Wet or Dry Use – 5/8" - 11 Threads

Item #	Diameter Inches /mm	Grit
VBCXTC4-1	4 x 5/8 x 11	Course 30/40
VBCXTM4-1	4 x 5/8 x 11	Medium 50/60
VBCXTF4-1	4 x 5/8 x 11	Fine 80/100



BREAKER BITS / PROFILERS

WDS PRO SERIES DOUBLE BREAKER BIT



Can be Used on or with 2, 3 & 4 cm Material – Wet Use. Changeable with Different Center Bearings “Included” Both M10 & M8 Bolts Included

Item# **DEBB -2/3/4**



WDS PRO SERIES VACUUM BRAZED PROFILERS

Wet or Dry Use – 5/8” - 11 Threads Connection
Center Bearing with Water Feed

Item#	Depth Inches /mm	Shape
VBPW-5R	3/16 / 5	Radius
VBPW-10R	3/8 / 10	Radius
VBPW-13R	1/2 / 13	Radius
VBPW-20HBN	3/4 / 20	Half Bull Nose
VBPW-114FBN	1 - 1/4	Full Bull Nose
VBPW-112FBN	1 - 1/2	Full Bull Nose



SMALL DIAMETER BLADES

TURBO BLADES

WDS SUPER TURBO – PRO SERIES



Wet or Dry Use – All Granites

Item#	Diameter Inches /mm	Arbor
STG4-H	4 / 100	7/8” - 20mm - 5/8”
STG4.5-H	4 1/2 / 115	7/8” - 20mm - 5/8”
STG5-H	5 / 125	7/8” - 20mm - 5/8” / 4 holes
STG6-H	6 / 155	7/8” - 5/8” / 4 holes
STG7-H	7 / 180	DM - 7/8” - 5/8”
STG8-H	8 / 200	7/8” - 5/8”
STG10-H	10 / 250	1” - 7/8” - 5/8”

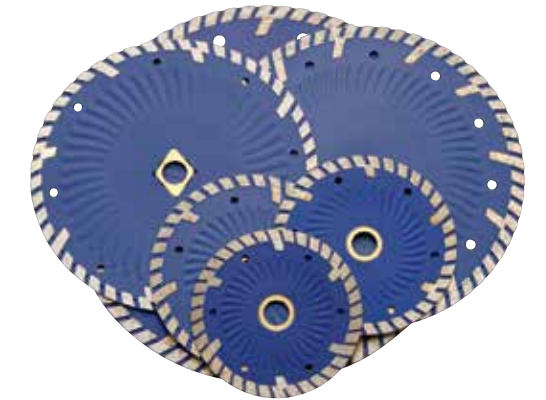

WDS SPIRAL TURBO – GREEN PRO SERIES



Wet or Dry Use – All Granites, Engineered Stone w/ Quartz

Item#	Diameter Inches /mm	Arbor
TSG4-H	4 / 100	7/8” - 20mm - 5/8” / 4 holes
TSG4.5-H	4 1/2 / 115	7/8” - 20mm - 5/8” / 4 holes
TSG5-H	5 / 125	7/8” - 20mm - 5/8” / 4 holes
TSG6-H	6 / 155	7/8” - 5/8” / 4 holes
TSG7-H	7 / 180	DM - 7/8” - 5/8”



SEGMENTED BLADES

WDS “POWER COMBO®” GPS SOFT BOND SERIES

Wet or Dry Use – Laser Welded – Segmented – Hard Granite

Item#	Diameter Inches /mm
SP4-5Q	4 / 100
SP4.5-5Q	4 1/2 / 115
SP5-5Q	5 / 125
SP6-5Q	6 / 150
SP7-5Q	7 / 180
SP8-5Q	8 / 200
SP9-5Q	9 / 225
SP10-5Q	10 / 250



WDS PRO SERIES GRANITE RODDING BLADES

Wet or Dry Use – 12mm Segment Height – Fast Cutting – .250” Thick

Item#	Diameter Inches /mm
STPX4-4N	4 / 100
STPX4.5-4N	4 1/2 / 115
STPX5-4N	5 / 125



FLEX WET POLISHERS

LW 1503 - 253.089

Compact 5" WET Polisher with central water feed

LW 1503 is the most demanded wet polisher in the industry. It is a compact, but powerful workhorse. Due to its light weight and portability, this product has become the "de facto" standard for all WET polishers. The LW 1503 is frequently used to polish surfaces and edges of natural stone (sink holes, counter top edges and other small stone surfaces). Velcro™ backing pads and diamond resin polishing pads are to be purchased separately.

Specifications LW 1503

Max. disc diameter 5"
 Speed, without load. 3,700 RPM
 Power input 7.4 AMP
 Weight 4.4 lbs

Standard Equipment

1 bail handle 236.934
 1 open-ended wrench 17mm . 106.461
 1 GFCI operator protection
 circuit breaker in cable 290.521



LW 603 VR - 253.692

Electronic 5" Variable Speed WET Polisher

The most cost-effective and sophisticated WET polisher. Infinitely adjustable polishing speeds (1,000-2,800 RPM) make this product ideal for very sensitive materials and offers users maximum flexibility. The LW 603 VR is a two-handed tool and is commonly used as a large surface polisher. Velcro™ backing pads and diamond resin polishing pads are to be purchased separately.

Specifications LW 603 VR

Max. disc diameter 5"
 Speed, without load. 1,000-2,800 RPM
 Power input 13 AMP
 Weight 7.5 lbs

Standard Equipment

1 bail handle 251.587
 1 open-ended wrench 17mm . 106.461
 1 GFCI operator protection
 circuit breaker in cable 259.990



LW 1202 S - 278.483

The FLEX WET stone polisher with FLEX metal composite housing and GFCI circuit breaker

The 13 AMP wet grinder for more flexibility under mobile conditions. The GFCI operator protection circuit breaker integrated into the power cord allows the two-handed grinder to be operated independently from an isolation transformer. Caution: For safety reasons, this unit should be operated only in conjunction with the GFCI operator protection circuit breaker!

Specifications LW 1202 S

Max. disc diameter 5"
 Speed, without load. 1,750 RPM
 Power input 13 AMP
 Weight 10.5 lbs

Standard Equipment

1 bail handle 258.545
 1 open-ended wrench 17 mm 106.461
 1 GFCI operator protection
 circuit breaker in cable 259.990



FLEX WET GRINDERS

LW 1509 - 288.896

This FLEX WET grinder is a true powerhouse

This compact 4-1/2" high speed WET grinder is designed for maximum material removal of concrete or natural stone. With its 8,300 RPM and 7.8 AMP motor, it is the fastest WET grinder in the market. It is intended for all heavy duty stone grinding applications (bulk material removal, edge breaking, coarse grinding of uneven surfaces and polish preparation work).

Specifications

Max. disc diameter 4-1/2"
 Speed, without load. 8,300 RPM
 Power input 7.1 AMP
 Weight 4.8 lbs

Standard Equipment

1 bail handle 236.934
 1 open-ended wrench 17mm 106.461
 1 GFCI operator protection
 circuit breaker in cable 290.521
 1 splash guard 289.183



LWW 1506 VR - 255.122

The versatile FLEX edge milling tool for marble and granite

LWW 1506 VR is the "smaller sibling" of the LWW 2106. The LWW 1506 VR is designed to handle up to 1-1/4" thick slabs for milling and grinding sinks, kitchen tops, counters, and tables. For use on both straight and curved edges. Caution: For safety reasons, this unit should be operated only in conjunction with the GFCI operator protection circuit breaker!

SPECIFICATIONS

Speed, without load. 2,200-6,500 RPM
 For slab thickness 3/4" - 1 1/4"
 Power input 10 AMP
 Weight 12-3/4 lbs

LWW 1506 VR

STANDARD EQUIPMENT

1 bail handle 258.545
 1 open-ended wrench 17 mm . 106.461
 1 GFCI operator protection circuit
 breaker in cable 259.990



LWW 2106 VR - 261.947

The powerful FLEX edge milling tool for granite

LWW 2106 VR is the "heavy duty" two-handed edge milling machine from FLEX. It is designed to handle up to 1-3/4" thick granite slabs. This product is ideally suited to round edges of larger natural stone surfaces (counters tops, tables or double basin kitchen sink holes). LWW 2106 VR is a portable tool yet has the power and flexibility of conventional stationary CNC machines.

SPECIFICATIONS

Speed, without load. 1,800-5,500 RPM
 For slab thickness 3/4" - 1 3/4"
 Power input 15 AMP
 Weight 22 lbs

LWW 2106 VR

STANDARD EQUIPMENT

1 Open-ended wrench 32 mm. 251.475
 1 Open-ended wrench 22 mm. 109.398
 1 Hex wrench 8 x 100 x 130 . . . 256.742
 1 Splash guard 257.226
 1 Guide carriage 256.005
 1 GFCI operator protection
 circuit breaker in cord 332.194



NOTES



GOT BLADES?



WE STOCK OVER
\$4.5 MILLION DOLLARS
IN INVENTORY FOR
YOUR CONVENIENCE.

GOT BLADES?



WE STOCK OVER
\$4.5 MILLION DOLLARS
IN INVENTORY FOR
YOUR CONVENIENCE.

Visit us online at:
www.worlddiamondsource.com