

## N O T I C E

THIS DOCUMENT HAS BEEN REPRODUCED FROM  
MICROFICHE. ALTHOUGH IT IS RECOGNIZED THAT  
CERTAIN PORTIONS ARE ILLEGIBLE, IT IS BEING RELEASED  
IN THE INTEREST OF MAKING AVAILABLE AS MUCH  
INFORMATION AS POSSIBLE

DOE/NASA/0124-1  
NASA CR-159835  
ERC LIB. 79168

(NASA-CR-159835) SMALL PASSENGER CAR  
TRANSMISSION TEST-CHEVROLET 200 TRANSMISSION  
Final Report (Eaton Engineering and Research  
Center) 381 p HC A17/MP A01 CSCL 13F

N80-28255

Unclas  
G3/85 28101

# SMALL PASSENGER CAR TRANSMISSION TEST— CHEVROLET 200 TRANSMISSION

M.P. Bujold  
Eaton Corporation  
Engineering & Research Center

**March 1980**

Prepared for  
NATIONAL AERONAUTICS AND SPACE ADMINISTRATION  
Lewis Research Center  
Under Contract DEN3-124

for  
**U.S. DEPARTMENT OF ENERGY**  
**Conservation and Solar Energy**  
**Office of Transportation Programs**



DOE/NASA/0124-1  
NASA CR-159835  
ERC LIB. 79168

# **SMALL PASSENGER CAR TRANSMISSION TEST— CHEVROLET 200 TRANSMISSION**

M.P. Bujold  
Eaton Corporation  
Engineering & Research Center  
Southfield, Michigan 48037

March 1980

Prepared for  
National Aeronautics and Space Administration  
Lewis Research Center  
Cleveland, Ohio 44135  
Under Contract DEN3-124

for  
U.S. DEPARTMENT OF ENERGY  
Conservation and Solar Energy  
Office of Transportation Programs  
Washington, D.C. 20545  
Under Interagency Agreement EC-77-A-31-1044

## PREFACE

The Electric and Hybrid Vehicle Research, Development, and Demonstration Act of 1976 (Public Law 94-413) authorized a Federal program of research and development designed to promote electric and hybrid vehicle technologies. The Energy Research and Development Administration, now the Department of Energy (DOE), which was given the responsibility for implementing the Act, established the Electric and Hybrid Vehicle Research, Development, and Demonstration Project within the Division of Transportation Energy Conservation to manage the activities required by Public Law 94-413.

The National Aeronautics and Space Administration under an Interagency Agreement (Number EC-77-A-31-1044) was requested by ERDA (DOE) to undertake research and development of propulsion systems for electric and hybrid vehicles. The Lewis Research Center was made the responsible NASA Center for this project. The work presented in this report is an early part of the Lewis Research Center program for propulsion system research and development for electric vehicles.

The work described in this report was conducted under Contract DEN3-124 with the National Aeronautics and Space Administration (NASA) and sponsored by the Department of Energy through an agreement with NASA.

TABLE OF CONTENTS

|   | <u>Page</u> |
|---|-------------|
| SUMMARY.....  | 1           |
| INTRODUCTION.....   | 1           |
| EQUIPMENT TESTED.....   | 2           |
| TEST APPARATUS.....   | 2           |
| TEST PROCEDURES.....  | 15          |
| TEST RESULTS.....   | 24          |
| DRIVE PERFORMANCE COVER SHEET.....  | 25          |
| Drive Performance 1st Gear Input Torque = 10 lb-ft .....                      | 27          |
| "                  "          "          "          "          20 lb-ft ..... | 32          |
| "                  "          "          "          "          30 lb-ft ..... | 37          |
| "                  "          "          "          "          40 lb-ft ..... | 42          |
| "                  "          "          "          "          45 lb-ft ..... | 47          |
| "                  "          "          "          "          50 lb-ft ..... | 52          |
| "                  "          "          "          "          60 lb-ft ..... | 57          |
| "                  "          "          "          "          70 lb-ft ..... | 62          |
| "                  "          "          "          "          80 lb-ft ..... | 67          |
| "                  "          "          "          "          90 lb-ft ..... | 72          |
| <br>DRIVE PERFORMANCE COVER SHEET.....  | <br>77      |
| Drive Performance 2nd Gear Input Torque = 10 lb-ft .....                      | 79          |
| "                  "          "          "          "          20 lb-ft ..... | 84          |
| "                  "          "          "          "          30 lb-ft ..... | 89          |
| "                  "          "          "          "          40 lb-ft ..... | 94          |
| "                  "          "          "          "          45 lb-ft ..... | 99          |
| "                  "          "          "          "          50 lb-ft ..... | 104         |
| "                  "          "          "          "          60 lb-ft ..... | 109         |
| "                  "          "          "          "          70 lb-ft ..... | 114         |
| "                  "          "          "          "          80 lb-ft ..... | 119         |
| "                  "          "          "          "          90 lb-ft ..... | 124         |
| <br>DRIVE PERFORMANCE COVER SHEET.....  | <br>129     |
| Drive Performance 3rd Gear Input Torque = 10 lb-ft .....                      | 131         |
| "                  "          "          "          "          20 lb-ft ..... | 136         |
| "                  "          "          "          "          30 lb-ft ..... | 141         |
| "                  "          "          "          "          40 lb-ft ..... | 146         |
| "                  "          "          "          "          45 lb-ft ..... | 151         |
| "                  "          "          "          "          50 lb-ft ..... | 156         |
| "                  "          "          "          "          60 lb-ft ..... | 161         |
| "                  "          "          "          "          70 lb-ft ..... | 166         |
| "                  "          "          "          "          80 lb-ft ..... | 171         |
| "                  "          "          "          "          90 lb-ft ..... | 176         |

PRECEDING PAGE BLANK NOT FILLED

TABLE OF CONTENTS (cont'd.)

|  | <u>Page</u> |
|--|-------------|
| CROSS SECTIONAL ROAD LOAD PERFORMANCE COVER SHEET.....       | 181         |
| Cross Sectional Road Load Performance 3rd Gear               |             |
| Output Torque =  | 183         |
| "    "    "    "    10 lb-ft .....                           | 188         |
| "    "    "    "    20 lb-ft .....                           | 193         |
| "    "    "    "    30 lb-ft .....                           | 198         |
| "    "    "    "    40 lb-ft .....                           | 203         |
| "    "    "    "    45 lb-ft .....                           | 208         |
| "    "    "    "    50 lb-ft .....                           | 213         |
| "    "    "    "    60 lb-ft .....                           | 218         |
| "    "    "    "    70 lb-ft .....                           | 223         |
| "    "    "    "    80 lb-ft .....                           | 228         |
| "    "    "    "    90 lb-ft .....                           |             |
| COAST PERFORMANCE COVER SHEET.....                           | 233         |
| Coast Performance 1st Gear Converter Torque = 10 lb-ft ..... | 235         |
| "    "    "    "    20 lb-ft .....                           | 240         |
| "    "    "    "    30 lb-ft .....                           | 245         |
| "    "    "    "    40 lb-ft .....                           | 250         |
| "    "    "    "    45 lb-ft .....                           | 255         |
| "    "    "    "    50 lb-ft .....                           | 260         |
| COAST PERFORMANCE COVER SHEET.....                           | 265         |
| Coast Performance 2nd Gear Converter Torque = 10 lb-ft ..... | 267         |
| "    "    "    "    20 lb-ft .....                           | 272         |
| "    "    "    "    30 lb-ft .....                           | 277         |
| "    "    "    "    40 lb-ft .....                           | 282         |
| "    "    "    "    45 lb-ft .....                           | 287         |
| "    "    "    "    50 lb-ft .....                           | 292         |
| "    "    "    "    60 lb-ft .....                           | 297         |
| "    "    "    "    70 lb-ft .....                           | 302         |
| "    "    "    "    80 lb-ft .....                           | 307         |
| "    "    "    "    90 lb-ft .....                           | 312         |
| COAST PERFORMANCE COVER SHEET.....                           | 317         |
| Coast Performance 3rd Gear Converter Torque = 10 lb-ft ..... | 319         |
| "    "    "    "    20 lb-ft .....                           | 324         |
| "    "    "    "    30 lb-ft .....                           | 329         |
| "    "    "    "    40 lb-ft .....                           | 334         |
| "    "    "    "    45 lb-ft .....                           | 339         |
| "    "    "    "    50 lb-ft .....                           | 344         |
| "    "    "    "    60 lb-ft .....                           | 349         |
| No Load Losses 1st Gear Closed Throttle.....                 | 354         |
| "    "    "    "    Open .....                               | 357         |
| "    2nd Gear Closed .....                                   | 360         |
| "    2nd Gear Open .....                                     | 362         |
| "    3rd Gear Closed .....                                   | 364         |
| "    3rd Gear Open .....                                     | 366         |
| APPENDIX.....  | A-1         |

## SUMMARY

The small passenger car transmission test was initiated to supply electric vehicle manufacturers with technical information regarding the performance of commercially available transmissions. This information would enable EV manufacturers to design a more energy efficient vehicle. With this information the manufacturers would be able to estimate vehicle driving range as well as speed and torque requirements for specific road load performance characteristics.

The first transmission tested was the 1979 Chevrolet 200 automatic transmission. This transmission was tested per a passenger car automatic transmission test code (SAE J651b) which required drive performance, coast performance, and no load test conditions. Under these test conditions, the transmission attained maximum efficiencies in the mid-eighty percent range for both drive performance tests and coast performance tests. The major result of this test is the torque, speed and efficiency curves which are located in the data section of this report. These graphs map the complete performance characteristics for the Chevrolet 200 transmission. This information will facilitate the vehicle manufacturer in the design of a more energy efficient vehicle.

## INTRODUCTION

The Chevrolet 200 transmission is a commercially available automatic transmission which is suited for a small passenger car installation. The transmission is equipped with three forward driving ranges, a neutral, reverse, and park. Very little technical information in the area of torque, speed and efficiency data is currently available on this transmission. This lack of available information was the principal reason for the initiation of this test.

The principal object of this test was to map torque, speed, and efficiency curves of the test transmission in each gear range, and in both drive performance and coast performance conditions. The test was performed per the specifications of the Passenger Car Automatic Transmission Test Code - SAE J651b. The torque and speed limits of this test were governed by the torque and speed limits of an engine which would typically be supplied with this transmission. The test code specified that three basic tests were to be conducted which involved holding the torque constant and varying the transmission speed. The three specific tests were drive performance, coast performance, and no load losses which were conducted in first, second and third gear.

The test code required that the transmission should be held in gear over the complete range of the test. In order to accomplish this, it was necessary to block the valves. This kept the transmission locked in gear. The test code also specified an oil temperature requirement to ensure that a set viscosity level be

attained throughout the tests. This temperature requirement was accomplished through the use of an immersion heater and oil cooler. The oil temperature was the main factor in limiting the amount of load that could be applied to the transmission.

The data that was obtained from the torque and speed sensors was placed directly onto tape. The tape was then fed into a computer which reduced the data and generated the necessary graphs and technical information. The main advantage to this method of data reduction is that any fluctuation that may occur due to system resonance is averaged by the computer. This method minimizes the error and allows the data to be viewed after the tests are completed.

### EQUIPMENT TESTED

This report involves the tests conducted on a Chevrolet 200 automatic transmission (Part No. 8628-827). The transmission consists primarily of a three-element hydraulic torque converter and a compound planetary gear set. Three multiple-disc clutches, a roller clutch, and a band provide the friction elements required to obtain the desired function of the compound planetary gear set.

The torque converter couples the engine to the planetary gears through oil and provides hydraulic torque multiplication when required. The compound planetary gear set produces three forward speeds and reverse.

The three-element torque converter consists of a pump or driving member, a turbine or driven member, and a stator assembly. The stator is mounted on a one-way roller clutch which will allow the stator to turn in the clockwise direction. This is a commercially available transmission which is suited for small passenger vehicles.

### TEST APPARATUS

The test apparatus used to operate the Chevrolet 200 transmission consisted of the following basic items which are described and listed below. The apparatus was basically the same for drive and coast performance tests with the exception of the transmission which was indexed 180 degrees for coast performance tests.

The driving dynamometer was used to power the transmission. A torque sensor was placed on the dynamometer shaft to accurately monitor the torque into the transmission. A speed pickup was placed on the dyno shaft to measure the speed into the transmission.

The output shaft of the transmission was coupled to a torque sensor which accurately measured its torque. An absorbing dynamometer was coupled to the rear torque sensor to apply load to the system. A speed pickup was mounted to the absorber shaft to measure output speed.



The transmission oil temperature was controlled through the use of a heat exchanger and circulation heater. When the transmission was operating at light load the oil cooler was shutdown and the circulation heater was engaged so that the oil could be kept up to temperature specification. When the transmission was operating under heavy load the oil cooler was operating and the circulation heater was disengaged so that the temperature specification was not exceeded.

The transmission was held in first gear by placing the gear selector lever in its appropriate setting. The transmission was held in second gear by blocking the 1 to 2 shift valve in the second position. The transmission was held in third gear by placing stops in the 1 to 2 shift valve and the 2 to 3 shift valve so the valves were kept in the 2 and 3 position respectively.

The instrumentation for the setup consisted of the following basic items. The Lebow torque sensor was used in conjunction with a Daytronic signal conditioner (878). The Himmelstein torque sensor was matched with a Daytronic signal conditioner (878A). The magnetic speed pickup was used with an Airpax speed readout. These signals were then fed into a Sangamo 3500 tape recorder. The tape recorded data were then fed into a Hewlett Packard Analyser which reduced the data.

**DESCRIPTION****PART NO.****MANUFACTURER**

|                     |                |                  |
|---------------------|----------------|------------------|
| Driving Dynamometer | Model 26G308   | General Electric |
| Flexible Coupling   | 226 SN         | Thomas-Rexnord   |
| Torque Sensor       | MCRT6-02T(2-3) | Himmelstein      |
| Pilot Bearing       | SFT-15         | Sealmaster       |
| Transmission        | 200            | Chevrolet        |
| Rear Bearing        | 209-SFF        | MRC              |
| Flexible Coupling   | 226 SN         | Thomas-Rexnord   |
| Torque Sensor       | 1648-5K        | Lebow            |
| Absorber            | 1014DG         | Dynumatic        |
| Heat Exchanger      | F-301-ER-2P    | Young            |
| Circulation Heater  | NWHO-2         | Chromalox        |
| Pressure Gage       | D-0252         | Marsh            |

**INSTRUMENTATION**

|                           |           |                     |
|---------------------------|-----------|---------------------|
| Torque Signal Conditioner | 878A      | Daytronic           |
| Torque Signal Conditioner | 878       | Daytronic           |
| Speed Readout             | 761400110 | Airpax              |
| Temperature Conditioner   | 810       | Daytronic           |
| Thermocouples             | 6610WBA2  | Applied Instruments |

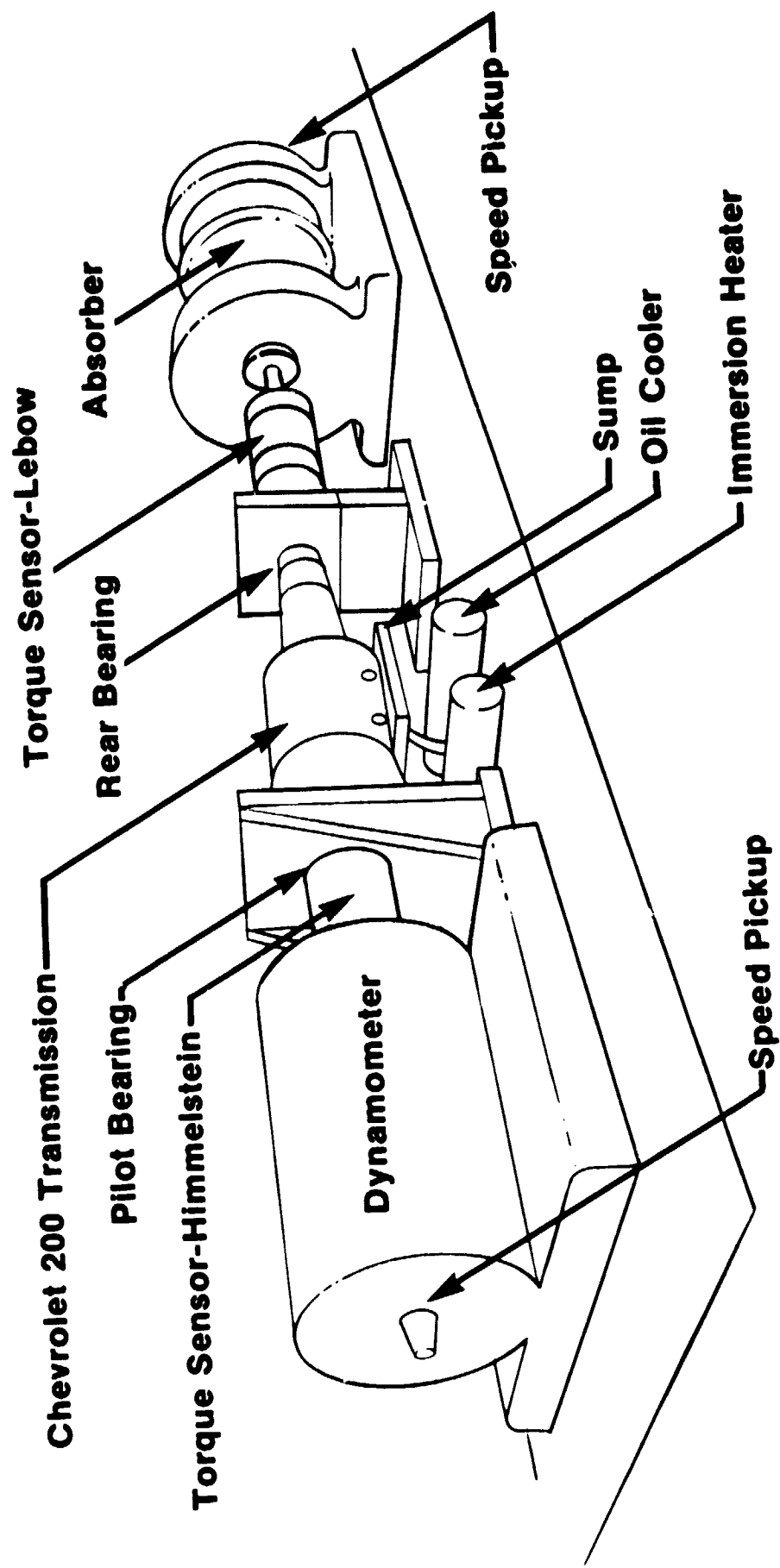

## Drive Performance Test Setup

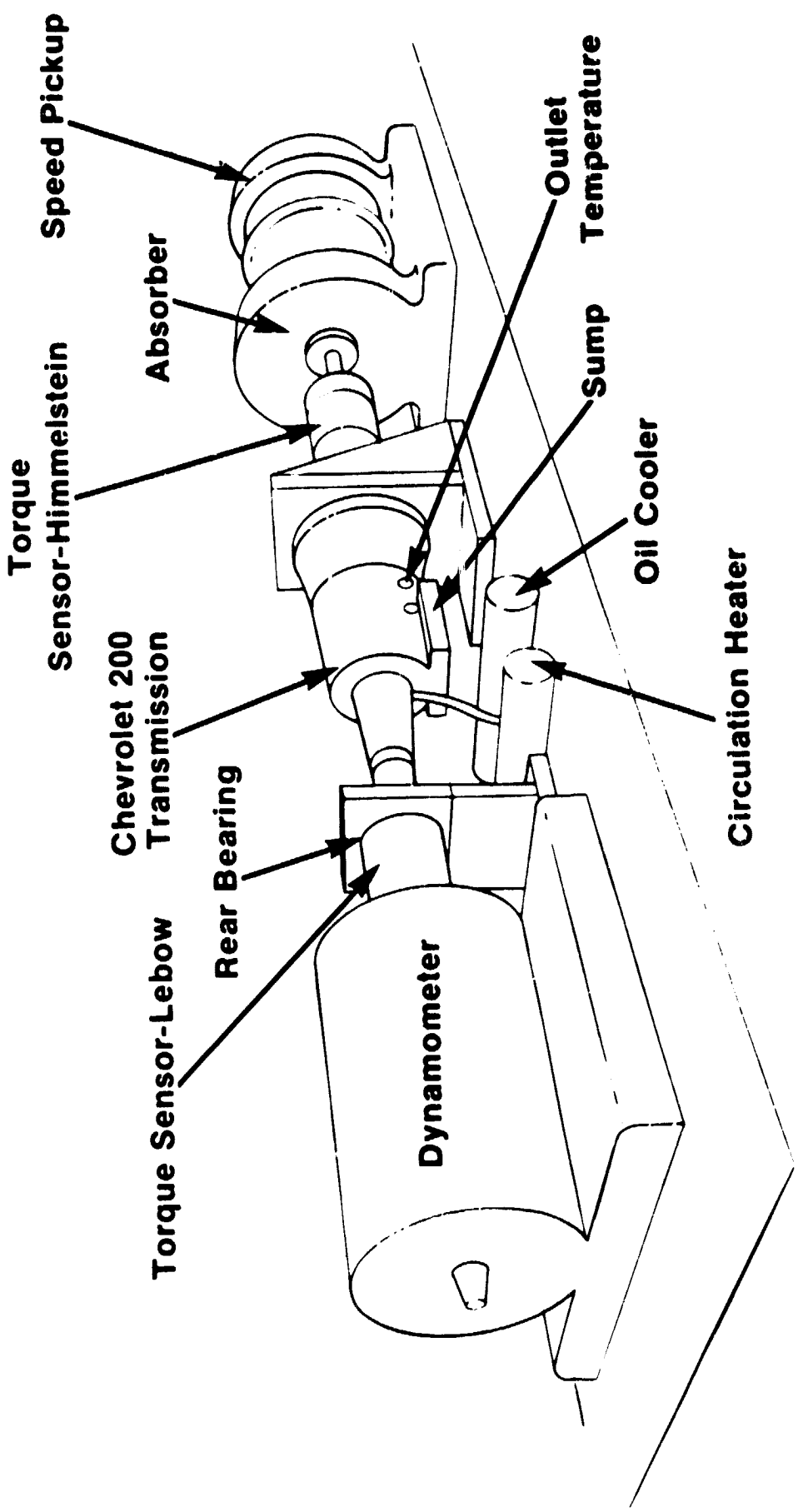

**Coast Performance Test Setup**

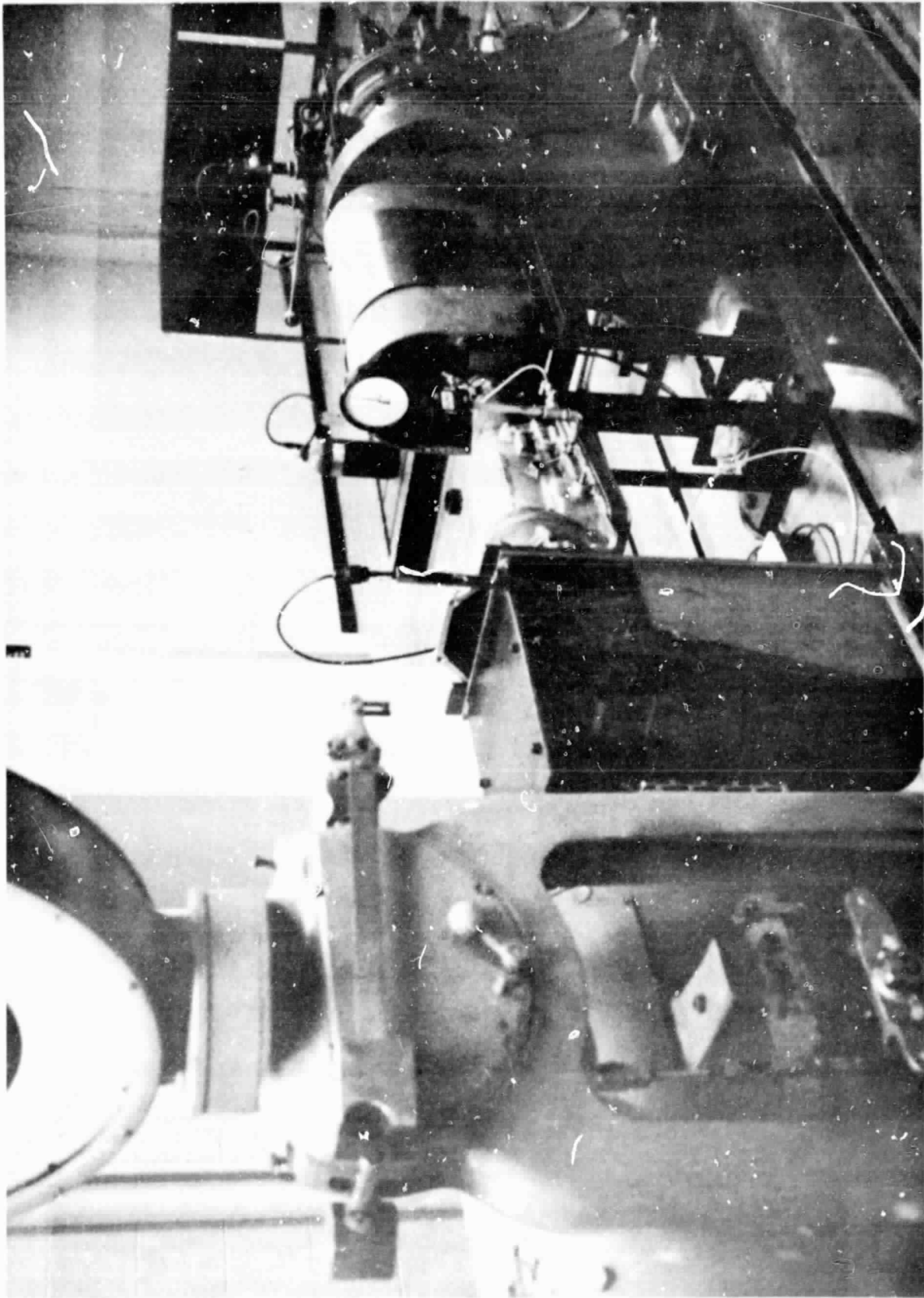

1979 Chevrolet 200 Transmission (Front View)

ORIGINAL PAGE IS  
OF POOR QUALITY

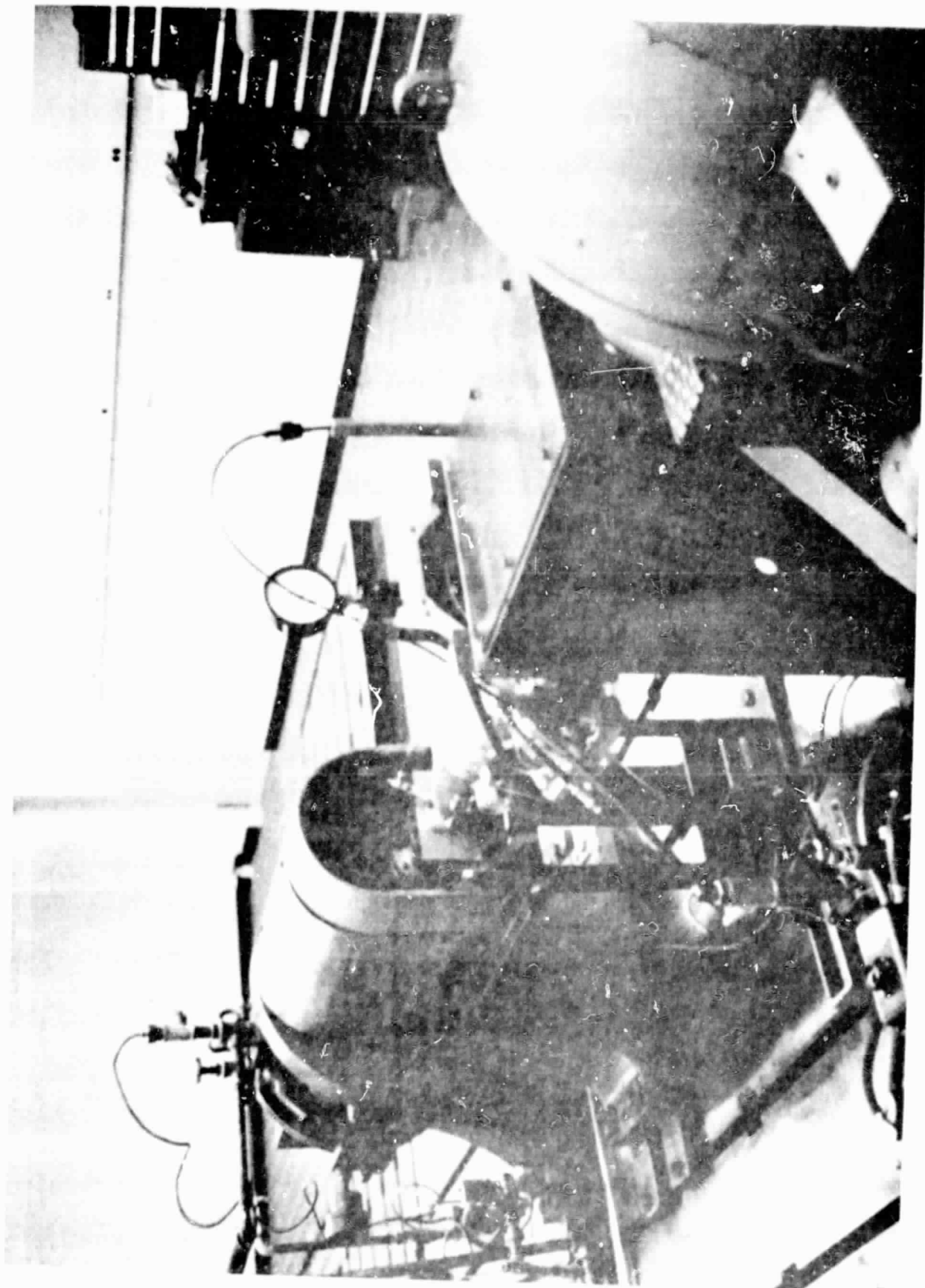

1979 Chevrolet 200 Transmission (Front View)

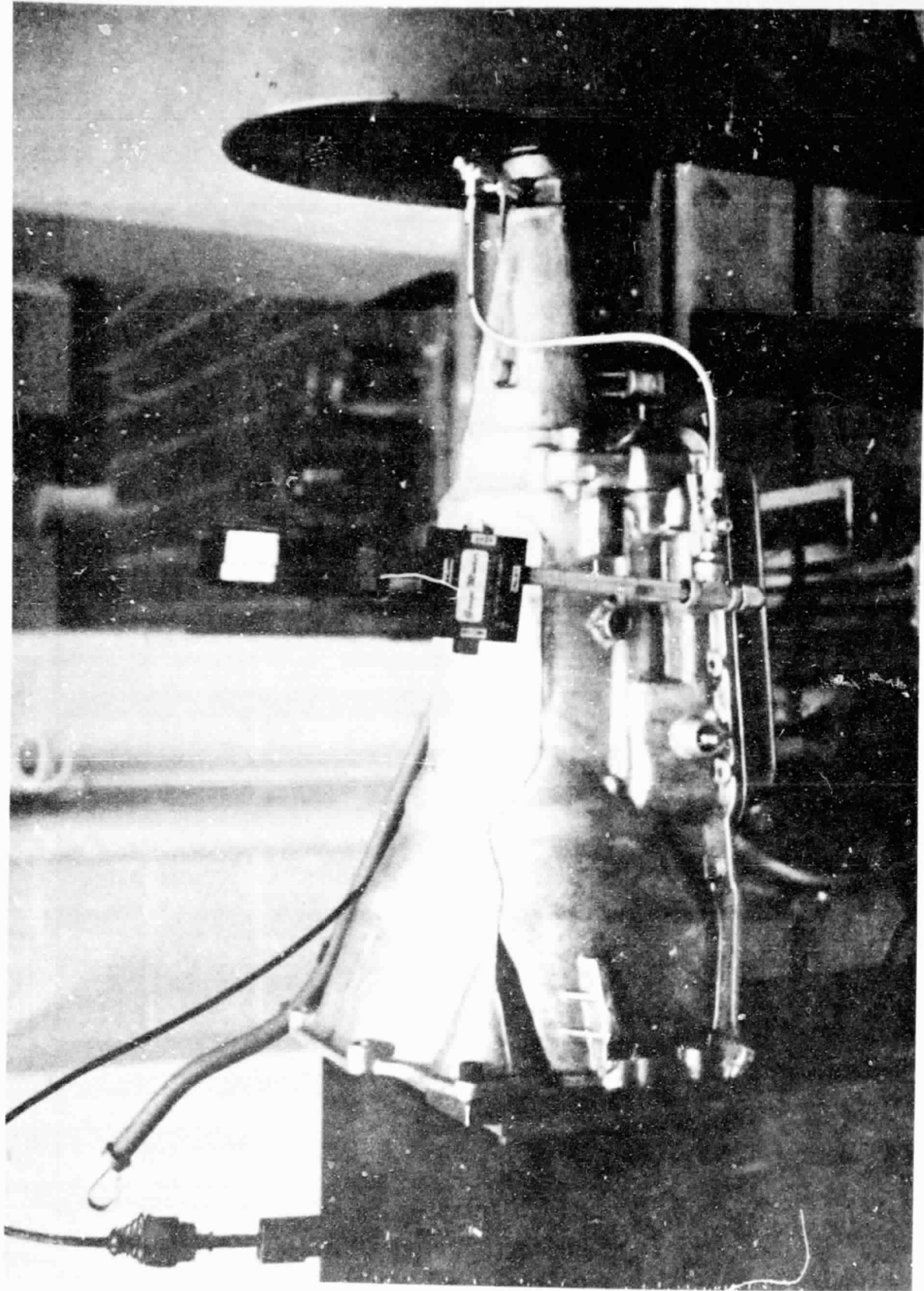

**1979 Chevrolet 200 Transmission (Side View)**

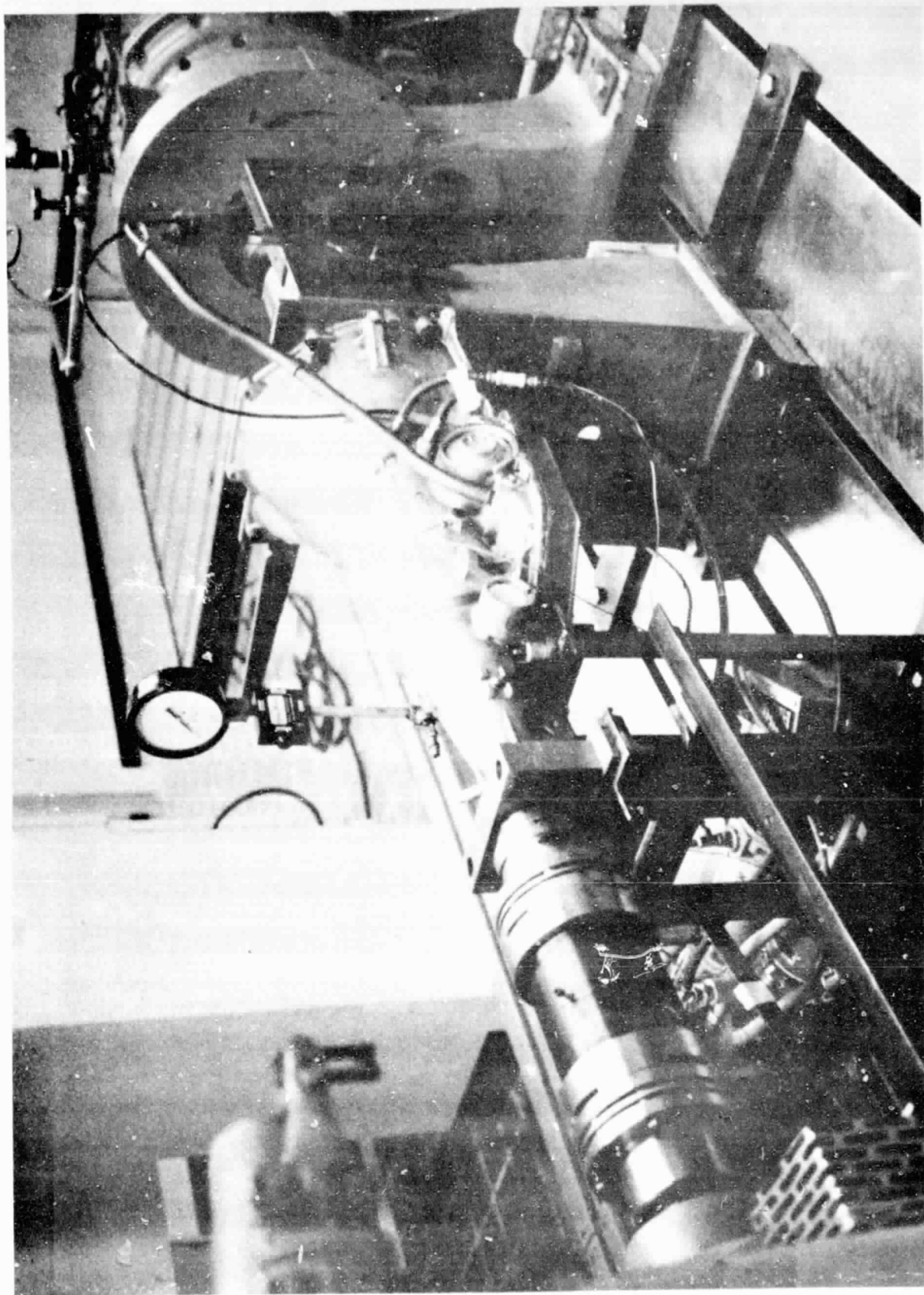

1979 Chevrolet 200 Transmission (Rear View)



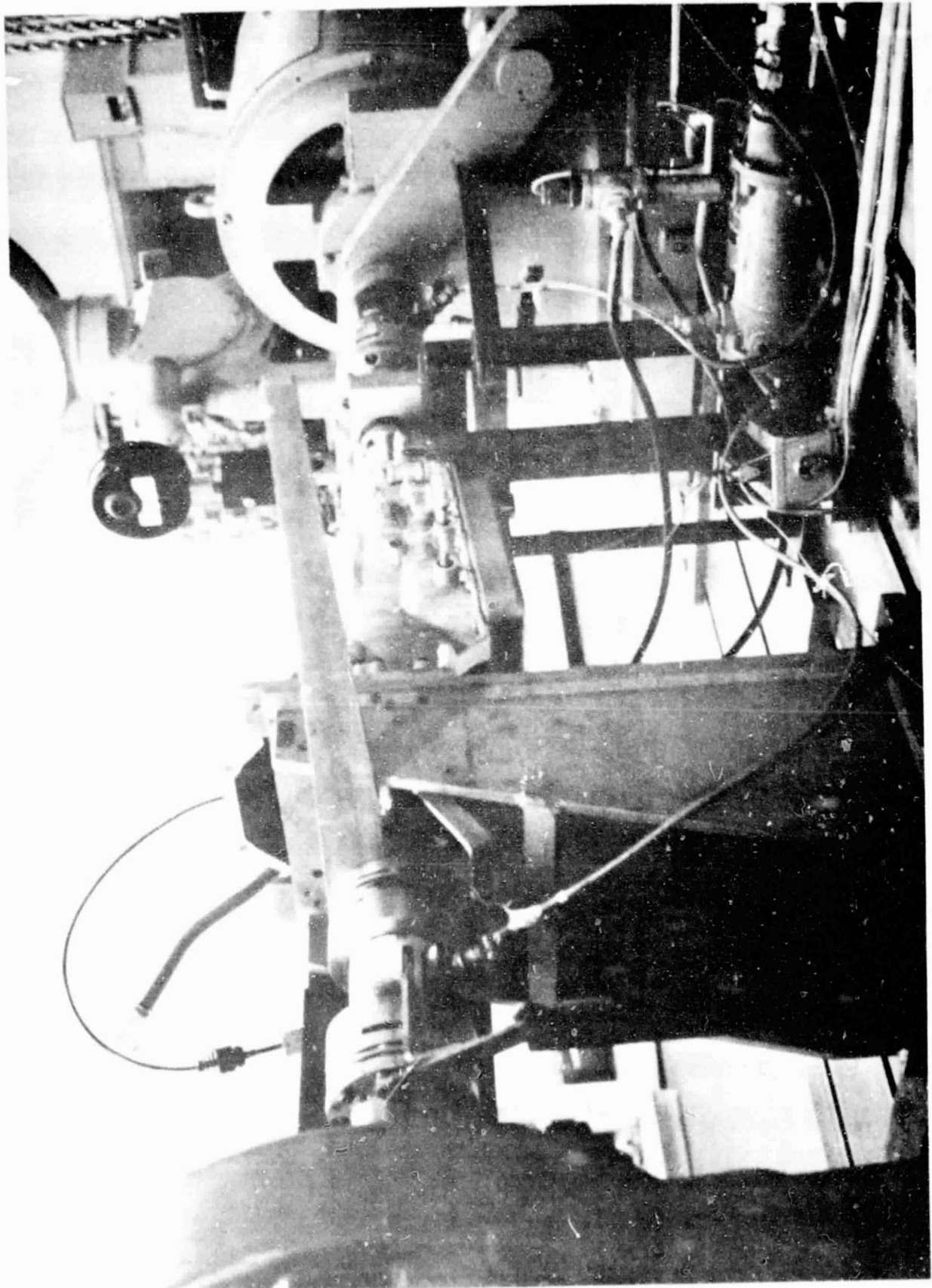

**1979 Chevrolet 200 Transmission Calibration**

ORIGINAL PAGE IS  
OF POOR QUALITY

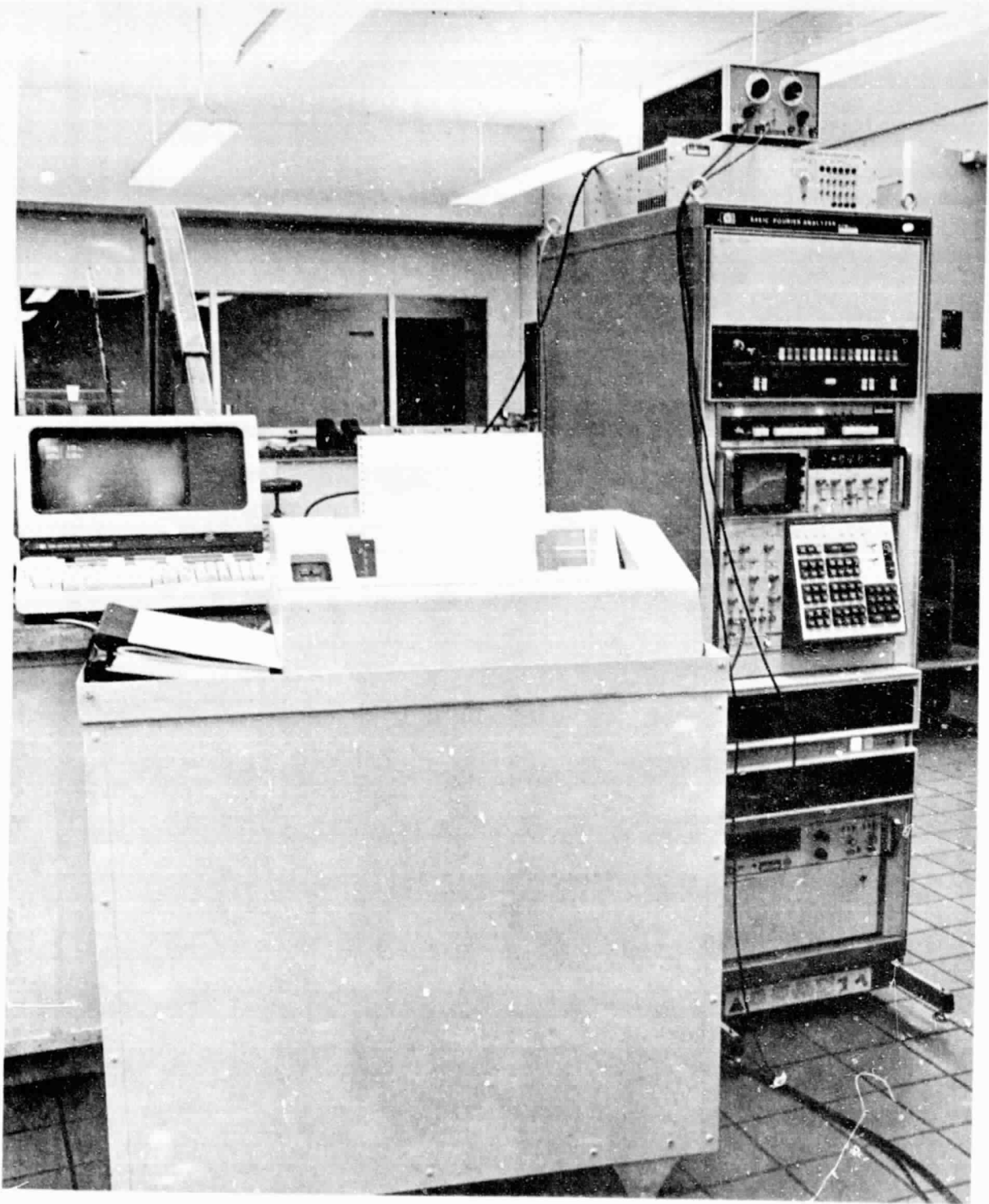

**Data Reduction Equipment**

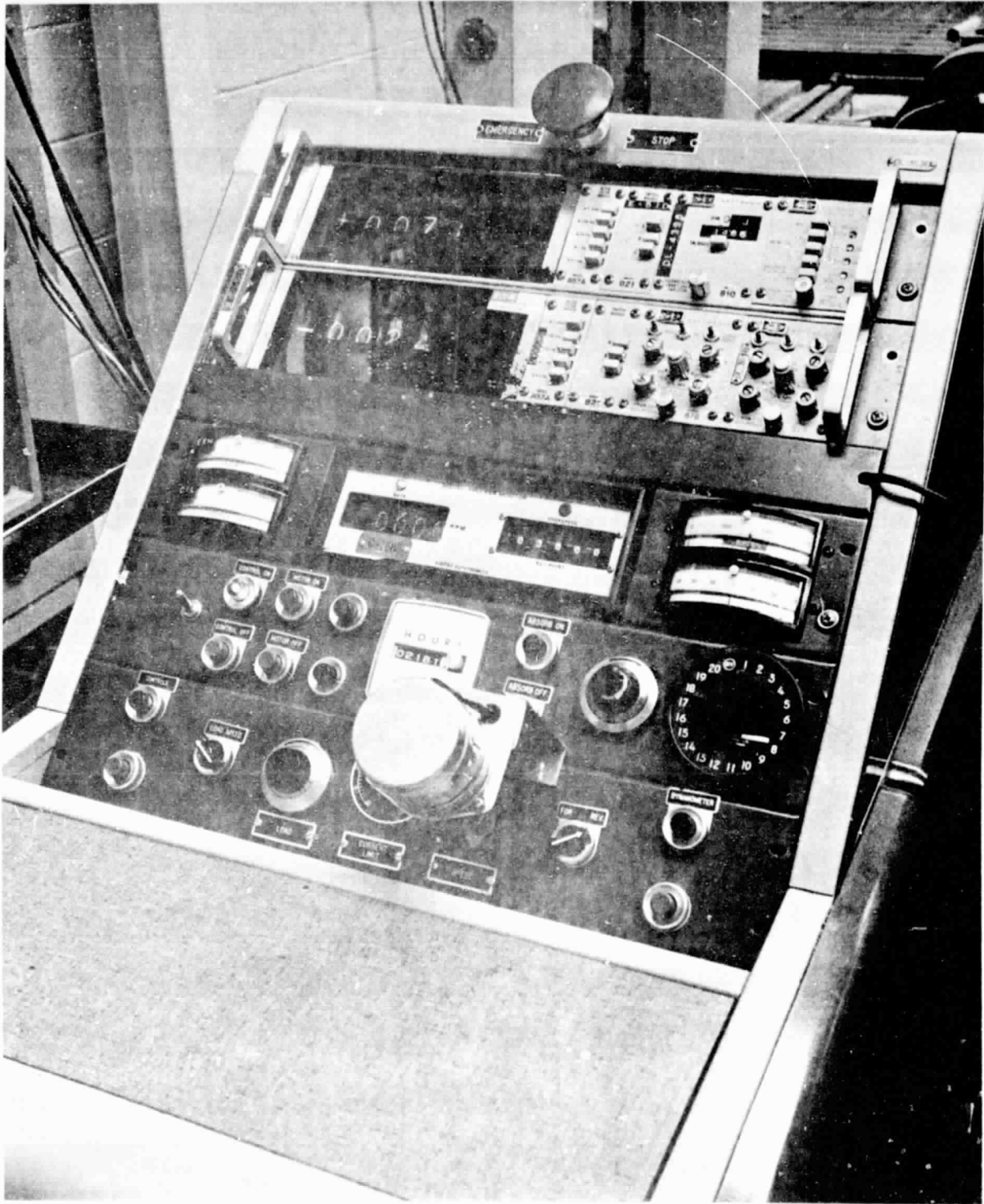

Control Console

ORIGINAL PAGE IS  
OF POOR QUALITY

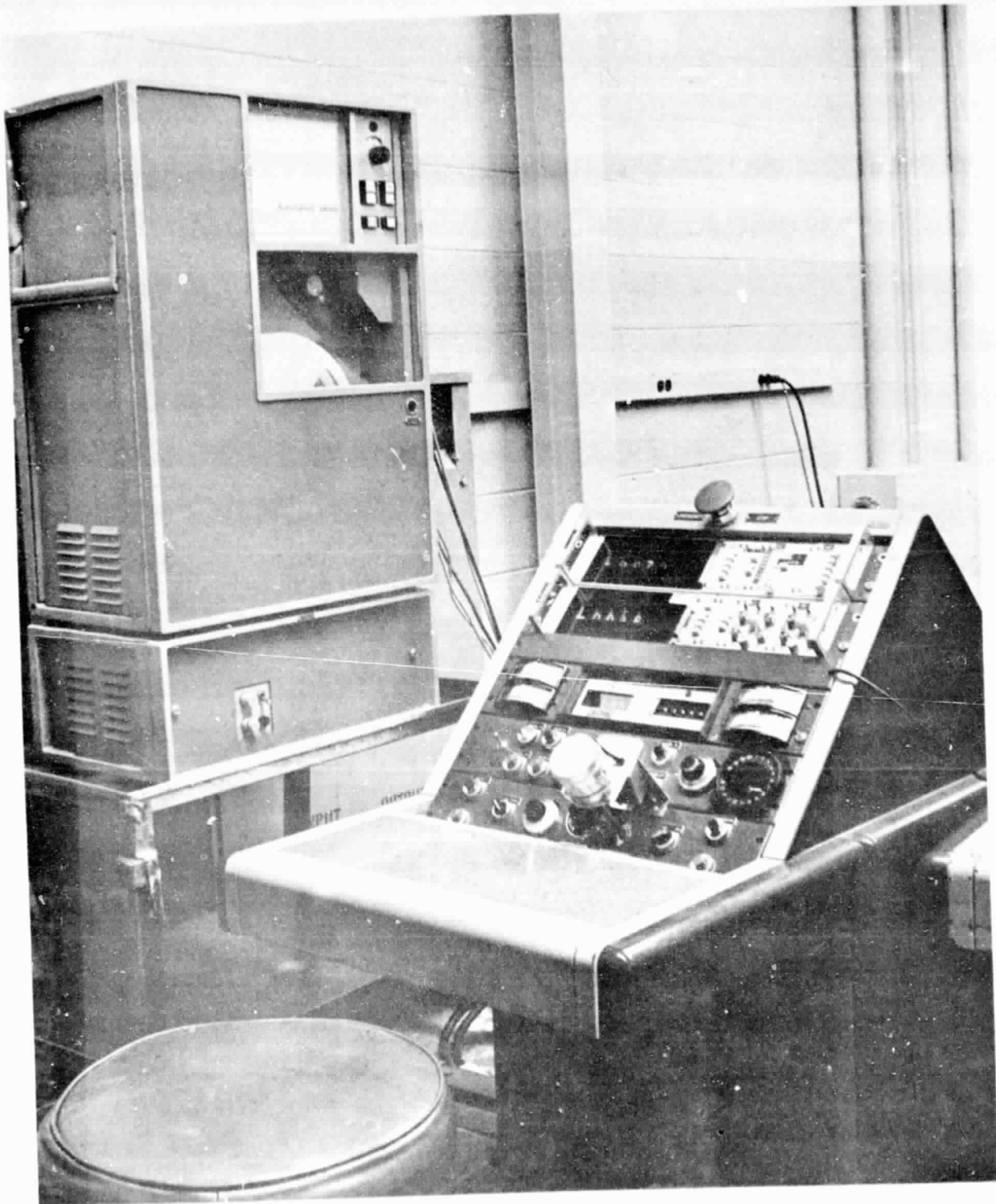

**Control Console with Tape Recorder**

## TEST PROCEDURE

The test was conducted per the Passenger Car Automatic Transmission Test Code-SAE J651b. The code states that three basic tests should be performed on the transmission. These tests were drive performance, coast performance and no load losses. Each test was performed to the accuracies stated in the code. The throttle valve was modulated throughout the test to its normal operating positions. The chart on page 17 indicates the engine torque and its related throttle valve position.

The first test conducted was the drive performance test. The limits of the test were determined by the normal operating conditions of an engine typically supplied with this transmission. The torque limit was set to 90 lb-ft, and the speed limit was set to 4500 rpm. The input shaft of the transmission was tested at a torque which ranged from 10-90 lb-ft on the input shaft of the transmission. The torque was incremented by 10 lb-ft for each test. The speed limits of the test ranged from 500 to 4500 rpm on the input shaft of the transmission.

Section 1 of the test code, which is labeled "Drive Performance - Constant Input Torque," was conducted first. The input torque was held at 10 lb-ft, and the speed was incremented from 500-4500 rpm. The torque was then set to 20 lb-ft, and the transmission was run through the same speed range. This procedure was followed for input torques of 10, 20, 30, 40, 45, 50, 60, 70, 80, and 90 lb-ft. The throttle valve was modulated to match the appropriate input torque for these test ranges. The starting speed was dependent on when the torque could be attained which was characteristic of the torque converter. The data recorded in this test were input and output speed, input and output torque, line pressure, sump temperature, outlet temperature, case hotspot temperature and ambient temperature.

This procedure was performed on the transmission in first, second and third gear range. The transmission was held in each gear through the entire torque and speed range per the explanation given in the test apparatus section of this report.

The next portion of the test to be conducted was the Cross Sectional Road Load Performance Test. This test was conducted in third gear and involved holding the transmission output shaft at a constant torque while varying the input speed. The output torques selected were 10, 20, 30, 40, 50, 60, 70, 80 and 90 lb-ft. The speed range was from 500-4500 rpm on the input shaft. The starting speed was dependent on when the torque could be attained. The throttle valve was modulated throughout the test to match the appropriate engine torque. The data recorded in this test were input and output torque, input and output speed, line pressure, sump temperature, outlet temperature, case hotspot temperature, and ambient temperature.

The No Load Loss portion of the test was performed next. This test was run with the output shaft turning freely. The input torque and speed were recorded for an entire speed range which ran from 500 rpm to 4500 rpm. This test was performed in each gear range by disconnecting the output shaft and allowing it to turn freely.

The parameters recorded in this test were input torque and speed, line pressure, sump temperature, outlet temperature, case hotspot temperature, and ambient temperature.

The final set of tests performed were the coast performance tests. For this test the transmission was oriented in the reverse direction so that the dynamometer drove through the output shaft of the transmission and the power was taken up in the absorber. The test was operated by setting the converter impeller torque at a constant level and varying its speed in the range set by the previous tests. In order to run this test, it was necessary to spin the torque converter shaft at approximately 400 rpm so that the charge pump would generate the line pressure necessary to operate the transmission. The torque and speed ranges of this test were different from the previous tests due to torque converter characteristics. The speed was limited by two conditions. These conditions were the lowest speed necessary to maintain line pressure and the lowest speed at which the torque could be attained. The amount of torque which could be applied to the system was limited by the temperature specification of the test code. The torques attained in the coast performance tests were lower than that for a given load on the system the torque converter rotated at a lower speed in coast performance than in drive performance. This resulted in a slower pump speed which meant less flow for cooling purposes. The data recorded during this portion of the test were input and output torque, input and output speed, line pressure, sump temperature, outlet temperature, case hotspot temperature, and ambient temperature. The throttle valve was set to the idle position during the entire test.

The transmission was filled with DEXTRON II automatic transmission fluid through the entire test schedule. The physical and chemical properties of the transmission fluid were monitored throughout the test. The color of the fluid did not change during the tests.

The only noticeable contaminants in the fluid were fine metallic shavings located at the base of the oil pan. This was attributed to initial gear teeth wear and is considered normal for this type of operation.

### THROTTLE VALVE MODULATION

The difference in the throttle valve setting from closed throttle to wide-open throttle was determined to be 0.625 in. The throttle valve was then modulated to the appropriate position and was dependent on the corresponding input torque for each test.

THROTTLE VALVE POSITION (in.)    INPUT TORQUE-IMPELLER TORQUE (lb-ft)

|       |                                 |    |
|-------|---------------------------------|----|
| 0.0   | <u>CLOSED THROTTLE POSITION</u> | 10 |
| 0.078 |                                 | 20 |
| 0.156 |                                 | 30 |
| 0.235 |                                 | 40 |
| 0.312 |                                 | 50 |
| 0.390 |                                 | 60 |
| 0.468 |                                 | 70 |
| 0.546 |                                 | 80 |
| 0.625 | <u>WIDE OPEN THROTTLE</u>       | 90 |

## CALIBRATION

The test apparatus was calibrated before and after a major test was completed. The major components calibrated were the torque sensors and the speed readouts. The torque sensors were calibrated with their respective readouts and attaching cables so that a total system accuracy was obtained. The calibration was performed by placing a set of known weights at a known distance to produce the resultant torque. The weights were weighed on a Toledo Digital Scale Model No. 1070, which is calibrated to a set of weights traceable to the National Bureau of Standards. The calibration arm was measured to a length of 24.00 inches. This length was recalculated for each weight which was placed on the calibration arm due to the deflection in the arm. The calibration sheets contained in this section show the calculated torque and the actual torque which appeared on the readout (measured torque). The torque sensors were calibrated to the limits of the range which they were to operate.

The speed readout was an AIRPAX counter (Model No. 761400110) which was calibrated in an operating range from zero to 4500 rpm. The counter was calibrated with a Hewlett Packard electric counter (Model No. 5245L) used in conjunction with a WWVB frequency comparator (True Time Inc. Model No. 60-TR). The accuracy of the digital readout was  $\pm 1$  count.



8/2/79

SMALL PASSENGER CAR TRANSMISSION TEST - CALIBRATION SHEETS  
HIMMELSTEIN: MODEL NO. MCRT 6-02-(2-3) CAL VALUE: 153.9 LB-FT

| <u>CALCULATED TORQUE</u>                               | <u>MEASURED TORQUE</u> |
|--|------------------------|
| Tray (8.175 lb) x (24) in. = 16.35 lb-ft               | 16.5 lb-ft             |
| (8.175 + 19.9 lb) x (23.99) in. = 56.13 lb-ft          | 56.3 lb-ft             |
| (8.175 + 19.9 + 19.995 lb) x (23.98) in. = 96.06 lb-ft | 96.1 lb-ft             |

LEBOW MODEL NO. 1648-5K

CAL VALUE: 260.8 LB-FT

| <u>CALCULATED TORQUE</u>                | <u>MEASURED TORQUE</u> |
|---|------------------------|
| (8.175 lb) x 24.0 in. = 16.35 lb-ft     | 16.2 lb-ft             |
| (28.12 lb) x 23.99 in. = 56.22 lb-ft    | 56.2 lb-ft             |
| (48.09 lb) x 23.98 in. = 96.10 lb-ft    | 96.2 lb-ft             |
| (68.07 lb) x 23.97 in. = 135.97 lb-ft   | 136.0 lb-ft            |
| (88.045 lb) x 23.96 in. = 175.80 lb-ft  | 176.0 lb-ft            |
| (107.995 lb) x 23.96 in. = 215.63 lb-ft | 215.8 lb-ft            |
| (127.97 lb) x 23.95 in. = 255.41 lb-ft  | 255.4 lb-ft            |
| (147.965 lb) x 23.94 in. = 295.19 lb-ft | 295.4 lb-ft            |
| (167.915 lb) x 23.94 in. = 334.99 lb-ft | 335.1 lb-ft            |

10/30/79

SMALL PASSENGER CAR TRANSMISSION - CALIBRATION SHEETS

HIMMELSTEIN: MODEL NO. MCRT 6-02-(2-3) CAL VALUE 153.9 LB-FT

CALCULATED TORQUE

MEASURED TORQUE

|  |            |
|--|------------|
| Tray (8.175 lb) x (1.998)ft = 16.33 lb-ft              | 16.6 lb-ft |
| (8.175 + 19.995 lb) x (1.997)ft = 56.26 lb-ft          | 55.9 lb-ft |
| (8.175 + 19.995 + 19.975 lb) x (1.996)ft = 96.10 lb-ft | 96.1 lb-ft |
| (8.175 + 19.995 lb) x (1.997)ft = 56.26 lb-ft          | 56.6 lb-ft |
| (8.175 lb) x (1.998)ft = 16.33 lb-ft                   | 16.7 lb-ft |

LEBOW: MODEL NO. 1648-5K

CAL VALUE 260.6 LB-FT

CALCULATED TORQUE

MEASURED TORQUE

|  |             |
|--|-------------|
| (8.175 lb) x 2.00 ft = 16.35 lb-ft     | 16.2 lb-ft  |
| (28.12 lb) x 1.99 ft = 55.96 lb-ft     | 56.2 lb-ft  |
| (48.06 lb) x 1.99 ft = 95.64 lb-ft     | 95.9 lb-ft  |
| (68.14 lb) x 1.99 ft = 135.60 lb-ft    | 136.3 lb-ft |
| (88.085 lb) x 1.998 ft = 175.99 lb-ft  | 176.6 lb-ft |
| (107.990 lb) x 1.998 ft = 215.76 lb-ft | 215.9 lb-ft |
| (127.985 lb) x 1.997 ft = 255.59 lb-ft | 255.1 lb-ft |
| (147.955 lb) x 1.997 ft = 295.47 lb-ft | 295.3 lb-ft |
| (167.925 lb) x 1.997 ft = 335.35 lb-ft | 335.5 lb-ft |

## SYSTEM ACCURACY

The instruments used in the test setup have been calibrated to ensure the accuracy of the test data. The individual components utilized in the tests contain manufacturers specifications which guarantee the accuracy of the instrumentation. These accuracies are listed and combined in the appendix section to determine the total system accuracy. The three major components involved in the system accuracy are the torque signals, speed signals, and data reduction equipment. Worst case system accuracies for the torque sensors, cabling and readouts were determined from the calibration charts and are shown below.

TAPE RECORDER: Sangamo Model #3500  
ACCURACY:  $\pm 0.05\%$  of Full Scale

TORQUE SENSOR: Lebow (1648-5K) + Daytronic (878A)  
ACCURACY:  $((\text{Calculated Torque} - \text{Measured}) / \text{Full Scale Torque}) \times (100)$   
 $(175.79 - 176.0) / (416.66) \times (100) = \pm 0.05\%$  of Full Scale

TORQUE SENSOR: Himmelstein (MCRT 6-62T(2-3)) + Daytronic (878)  
ACCURACY:  $((\text{Calculated Torque} - \text{Measured}) / \text{Full Scale Torque}) \times (100)$   
 $((56.26 - 55.9) / (166.66)) \times (100) = \pm 0.21\%$  of Full Scale

SPEED SENSOR: Speed Pickup + Airpax Counter  
ACCURACY: Calibration was  $\pm 1$  Count  $(1/4000) \times (100) = \pm 0.025\%$  of Full Scale

SPEED CONDITIONER (Frequency to Voltage Converter-Daytronic 840)  
ACCURACY: 0.05% of Average DC Voltage  $\pm 0.10\%$  of Full Scale

HEWLETT PACKARD ANALYZER (HP 5451B Fourier Analyzer)  
ACCURACY: 12 Bits =  $2^{11} = 2048$  Bits = 1 Volt  
 $(1/2048) \times (100) = \pm 0.048\%$  of Full Scale

COMPUTER INTER NUMBER CALCULATION (Method of Program Calculation)  
= 0.5% of Full Scale

The inter number calculation error resulted from the method that the computer used to average the acquired data. This method is explained in the appendix under calculation of error.

From the instrument accuracy determined above, a system accuracy may be determined. There are two generally accepted methods for calculating a system error. These methods are the root mean square and the sum of the errors. Both methods are tabulated in the appendix and charted below for torque, speed, power and efficiency readings.

|                      | <u>ROOT MEAN SQUARE METHOD</u><br><u>% OF FULL SCALE</u> | <u>SUM OF ERRORS METHOD</u><br><u>% OF FULL SCALE</u> | <u>FULL SCALE</u> |
|----------------------|--|---|-------------------|
| Torque Error (Lebow) | 0.08%  | 0.15%   | 416 lb-ft         |
| Torque Error (Himm.) | 0.221%   | 0.31%   | 166 lb-ft         |
| Speed Error          | 0.124%   | 0.223%  | 4000 RPM          |
| Power Out Error      | 0.50%  | 0.70%   | 90 HP             |
| Efficiency Error     | 0.58%  | 1.0%  | 100%              |

## DATA REDUCTION

The signals obtained from the torque and speed transducers of the test stand were placed directly onto a Sangamo Tape Recorder Model No. 3500. The information on the tape was then fed into a computer which was used to compile the data. While in the computer, the data were reviewed to insure their accuracy and then a hard copy was printed out on a line printer.

The following procedure was used to record the input and output torque. The torque signals were placed on the tape recorder as voltage. A calibration value was determined in engineering units (lb-ft) for each torque sensor. The torques were recorded on channels one and two in the following manner:

CHANNEL 1: PRECALIBRATION ZERO CALIBRATION VOLTAGE PRERUN  
ZERO DATA

CHANNEL 2: PRECALIBRATION ZERO CALIBRATION VOLTAGE PRERUN  
ZERO DATA

This information was then fed into the Hewlett Packard Analyzer which integrated and compiled a 2.5 second sample of data to obtain an average value in engineering units.

The frequency signals from the speed pickups were placed directly onto the tape recorder. The data on the tape were then fed into a frequency to voltage unit which turned the frequency into a dc voltage which in turn was fed into the computer. The method for recording speeds is shown below.

CHANNEL 3: ZERO FREQUENCY CALIBRATION FREQUENCY PRERUN ZERO  
FREQUENCY DATA

CHANNEL 4: ZERO FREQUENCY CALIBRATION FREQUENCY PRERUN ZERO  
FREQUENCY DATA

The data on these channels were then fed into the computer which integrated and compiled a 2.5 second sample of data to obtain an average speed value in engineering units.

The computer was programmed to take the values of torques and speeds and calculate efficiency and power from them. From the data it has generated, the computer would print out the required graphs and data per the contract specification. The main advantage to taking data in this manner was that the computer would calculate an integrated average which would minimize the error in a fluctuating signal. Any fluctuation due to system resonance or gear meshing would be integrated and averaged.

## TEST RESULTS

The data contained in this segment of the report have been divided into three major sections. These sections are drive performance, coast performance, and no load losses. There are five data sheets for each test condition in the drive performance and coast performance tests. The organization of this data is described and listed in the table of contents. Cover sheets for drive performance, coast performance and no load losses have been placed at the beginning of each section to describe the enclosed sheets.

**DRIVE PERFORMANCE**

**1st Gear**

## Graphs Contained in This Section

Torque Ratio -vs- Output Speed  
Output Torque -vs- Output Speed  
Input Speed -vs- Output Speed  
Efficiency -vs- Output Speed  
Efficiency -vs- Power Out

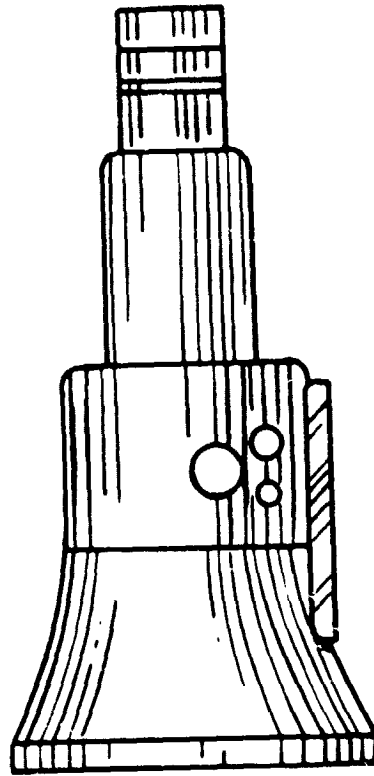

Torque In  
Speed In

Torque Out  
Speed Out

---

Drive Performance Tests



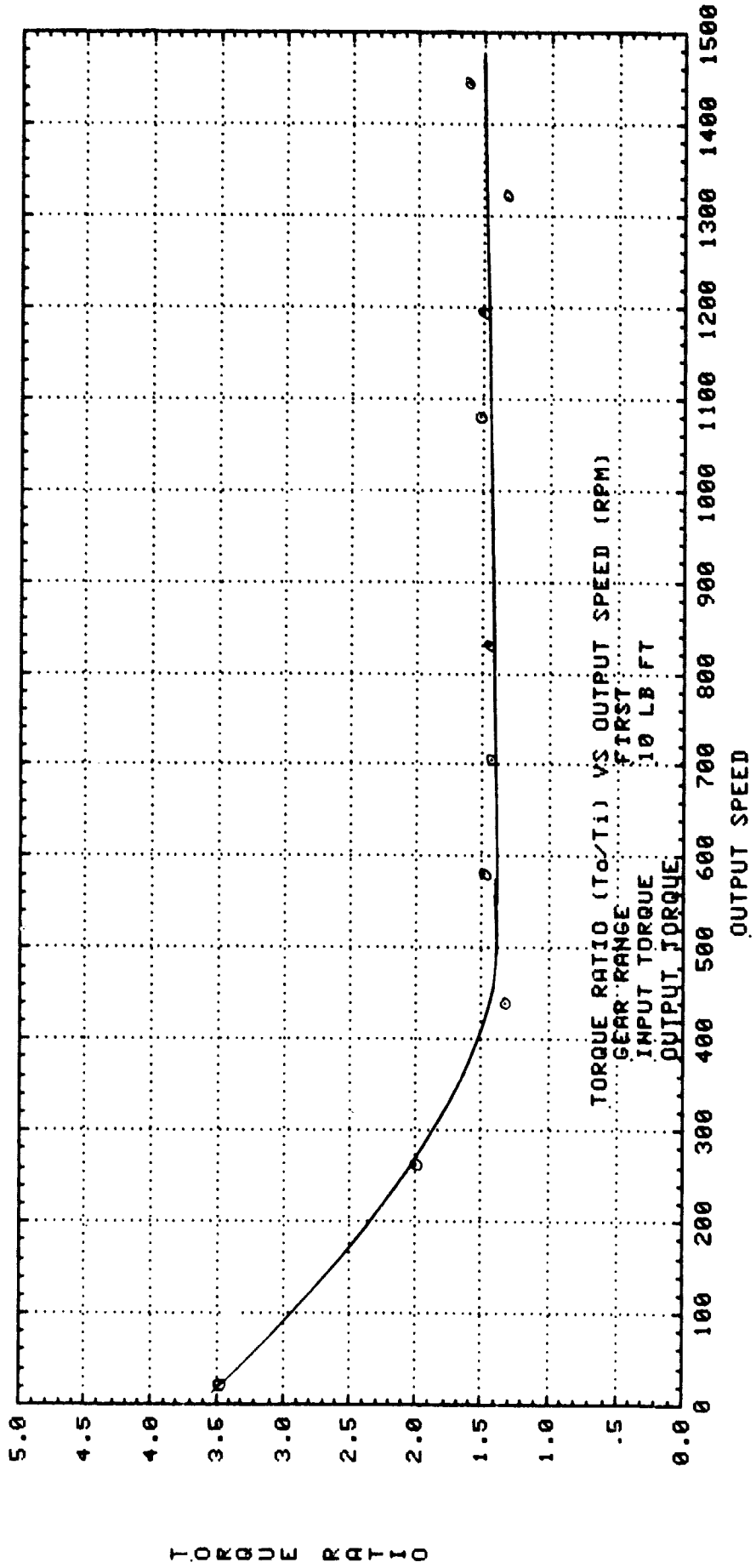

T O R Q U E R A T I O

OUTPUT TORQUE

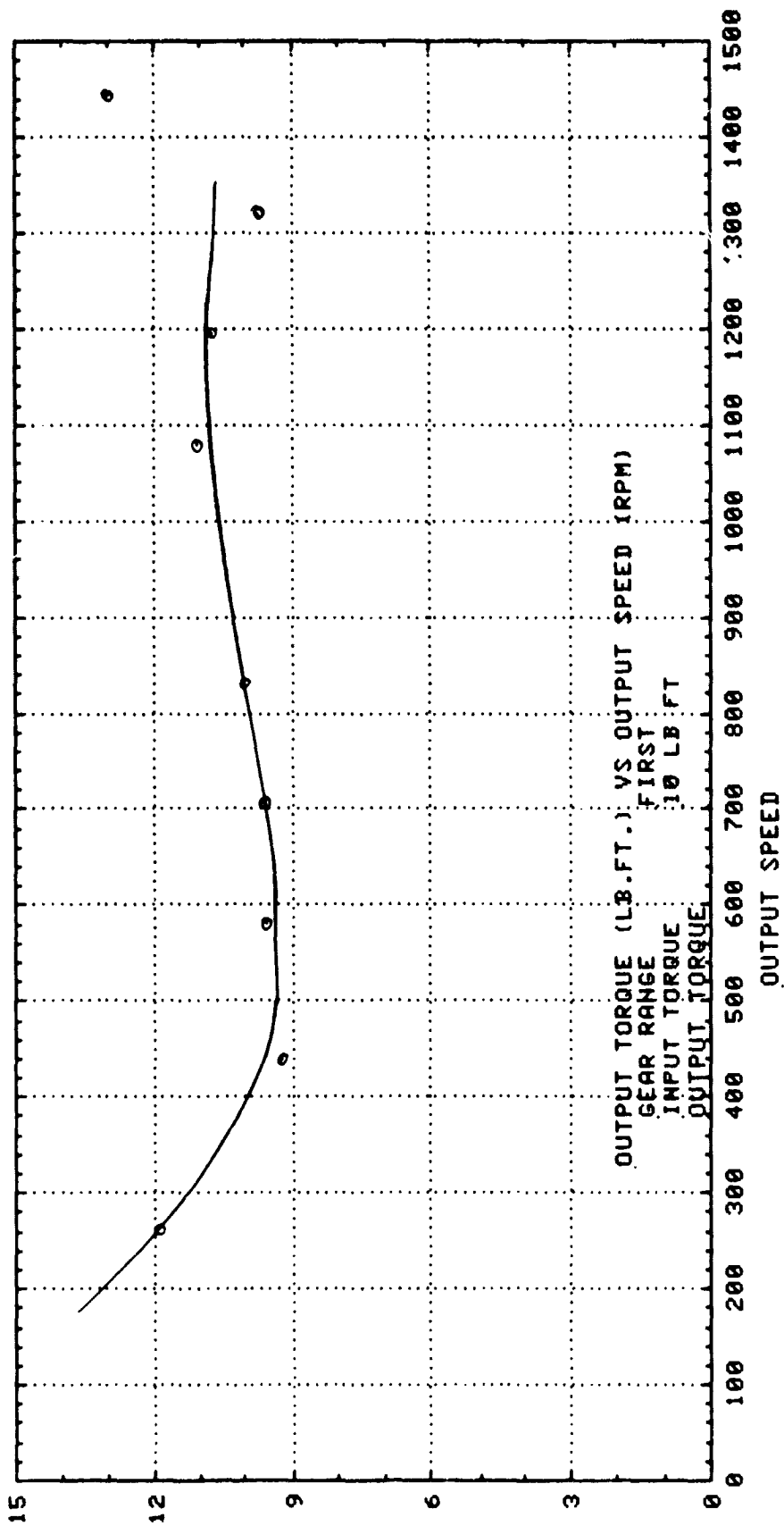

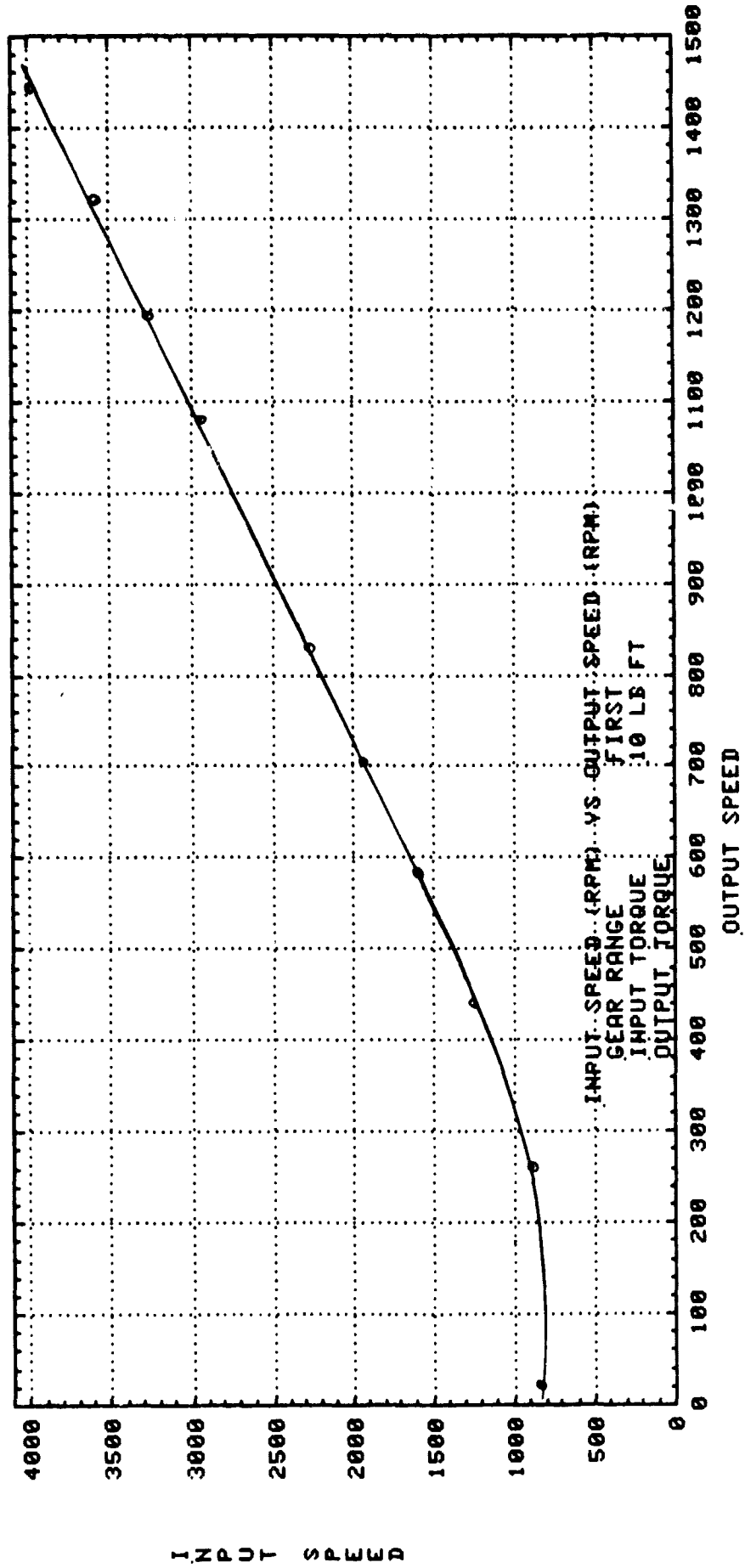

INPUT SPEED

EFFICIENCY

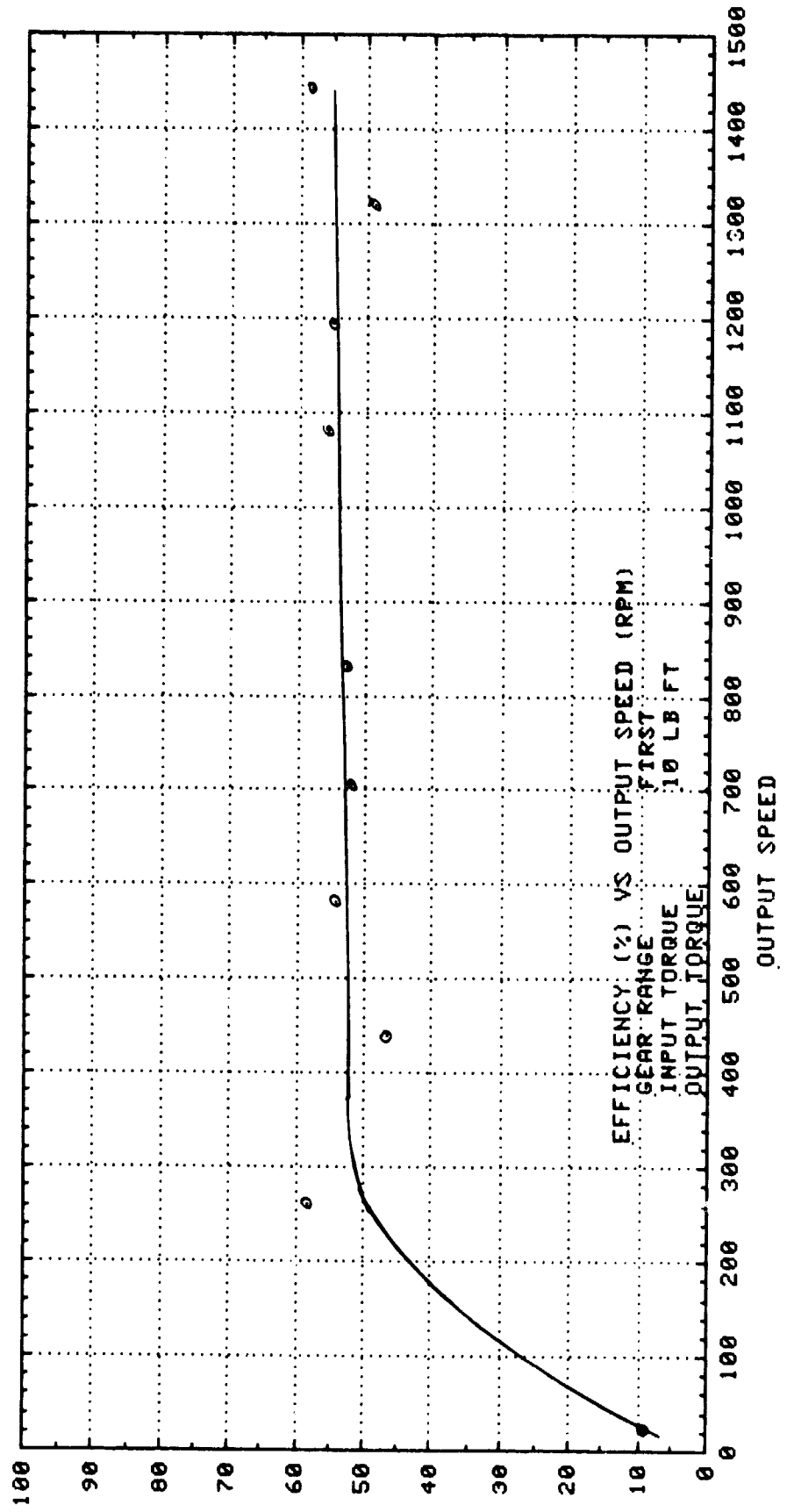

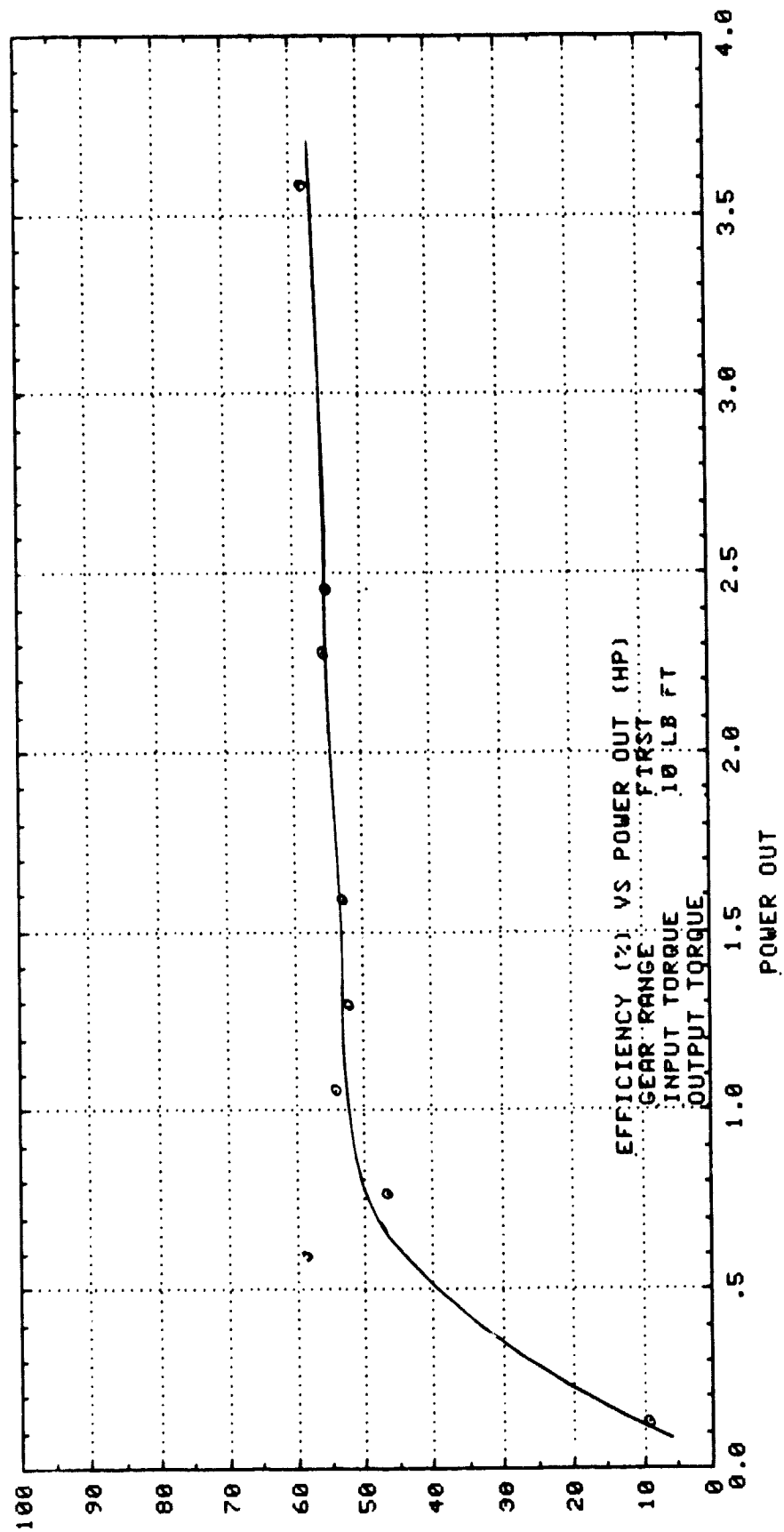

EFFICIENCY

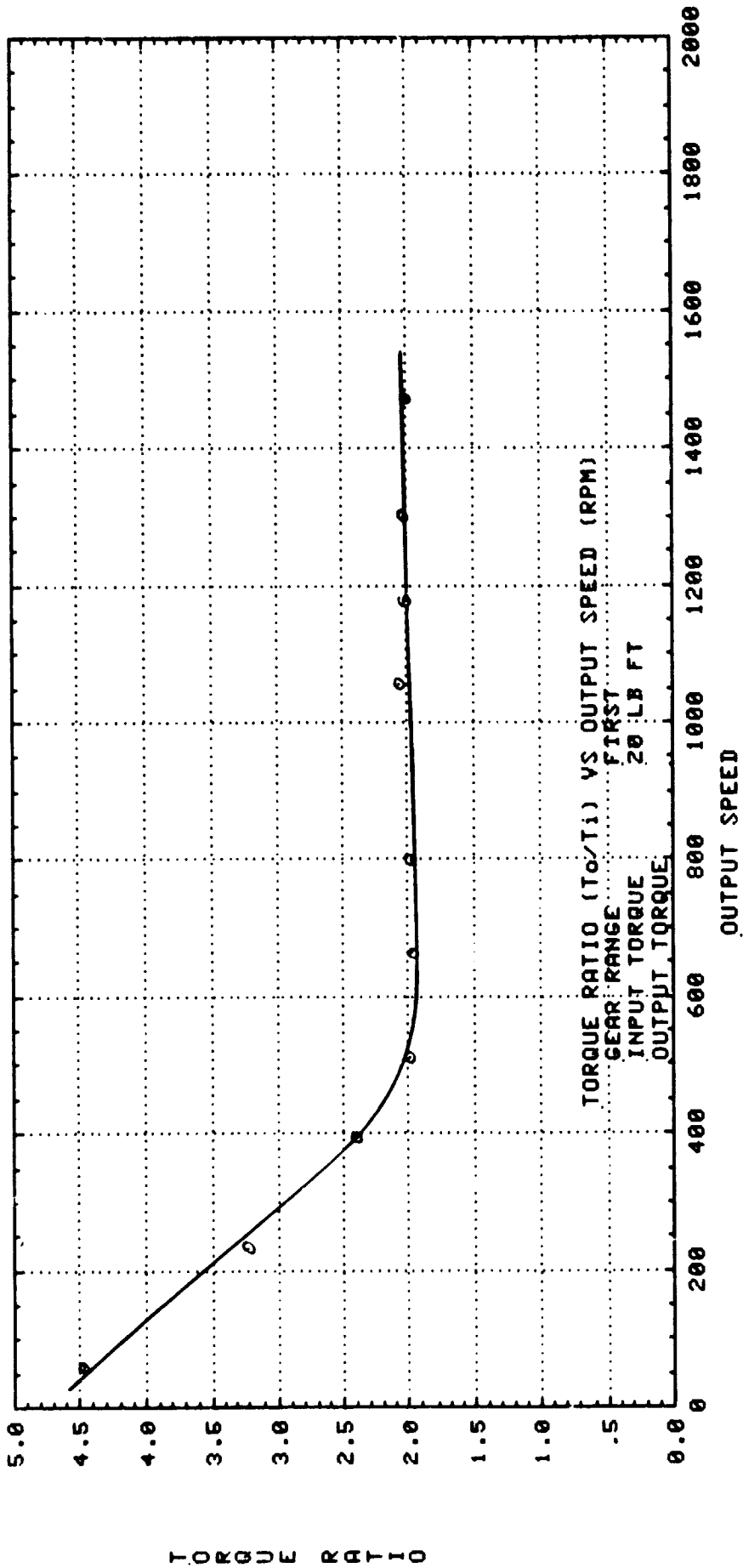

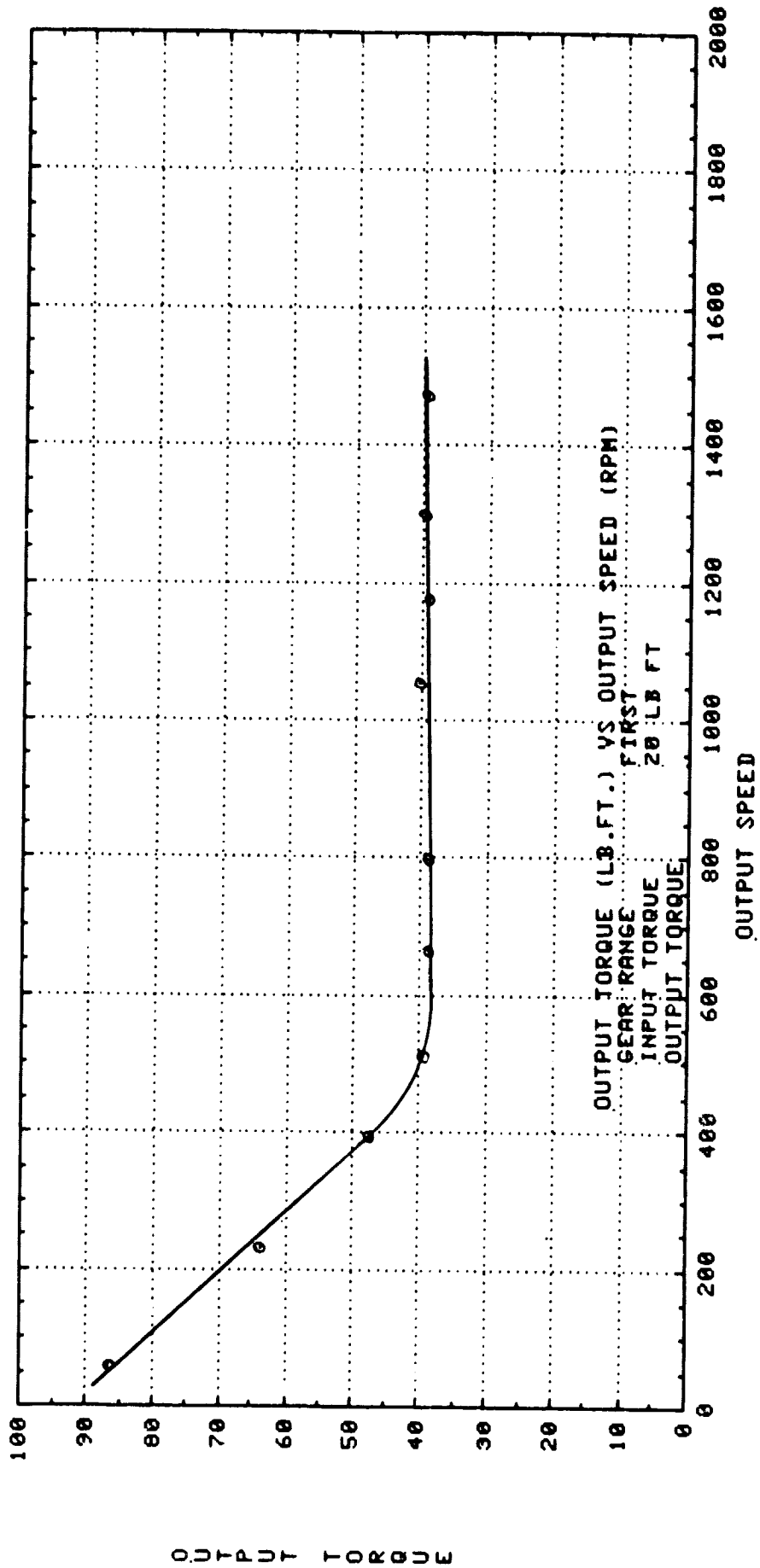

OUTPUT TORQUE

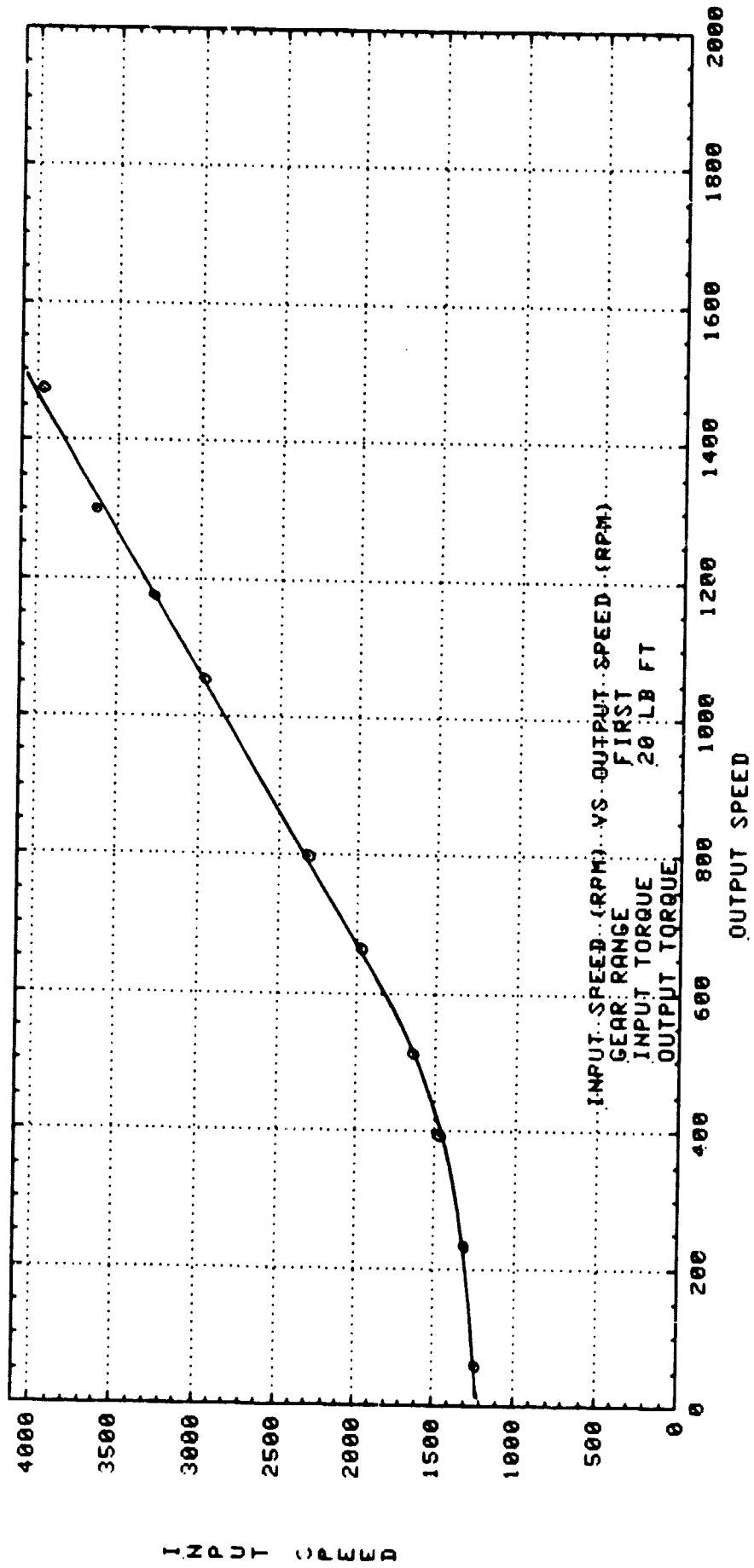



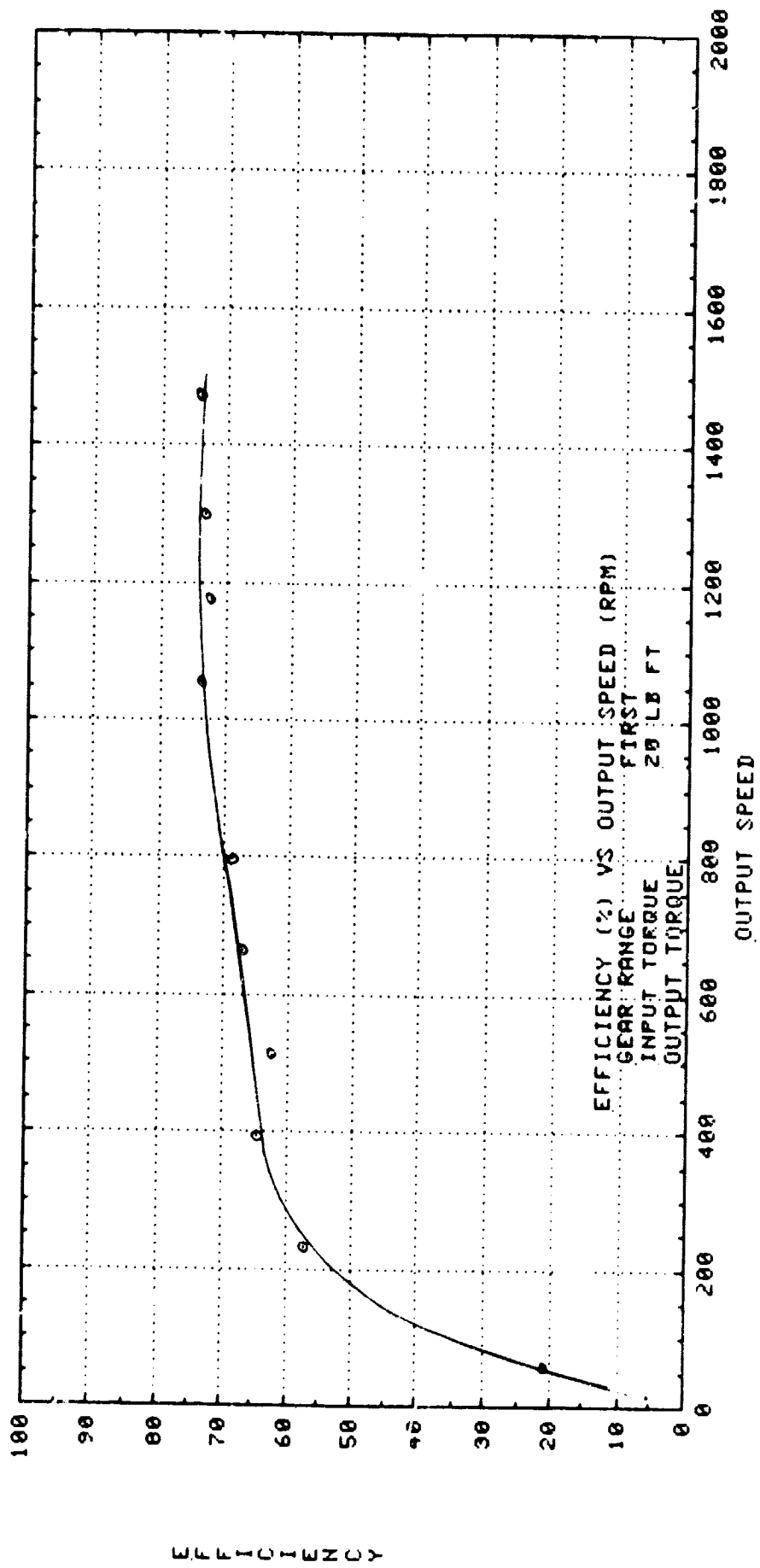

EFFICIENCY

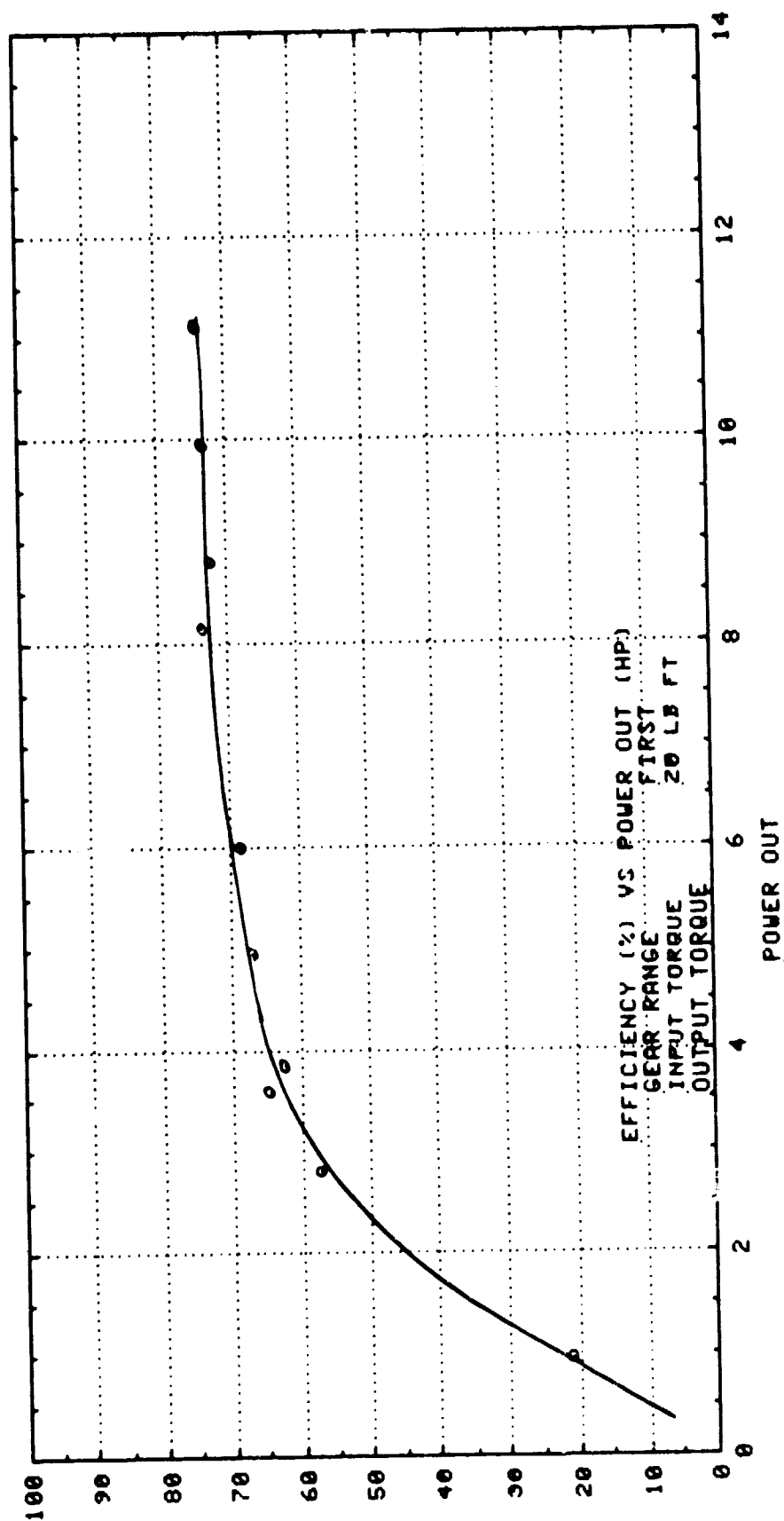

EFFICIENCY

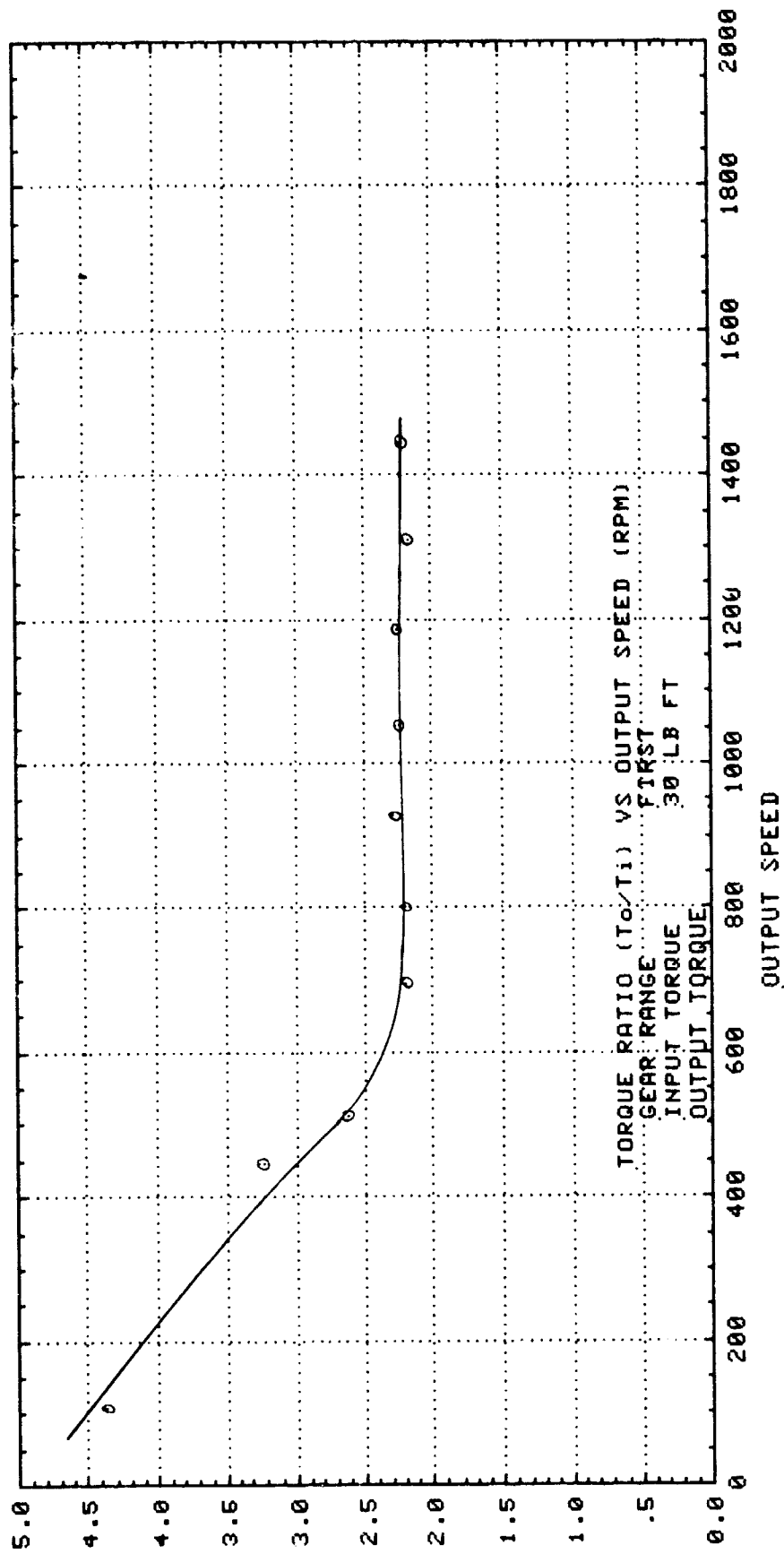

TORQUE RATIO

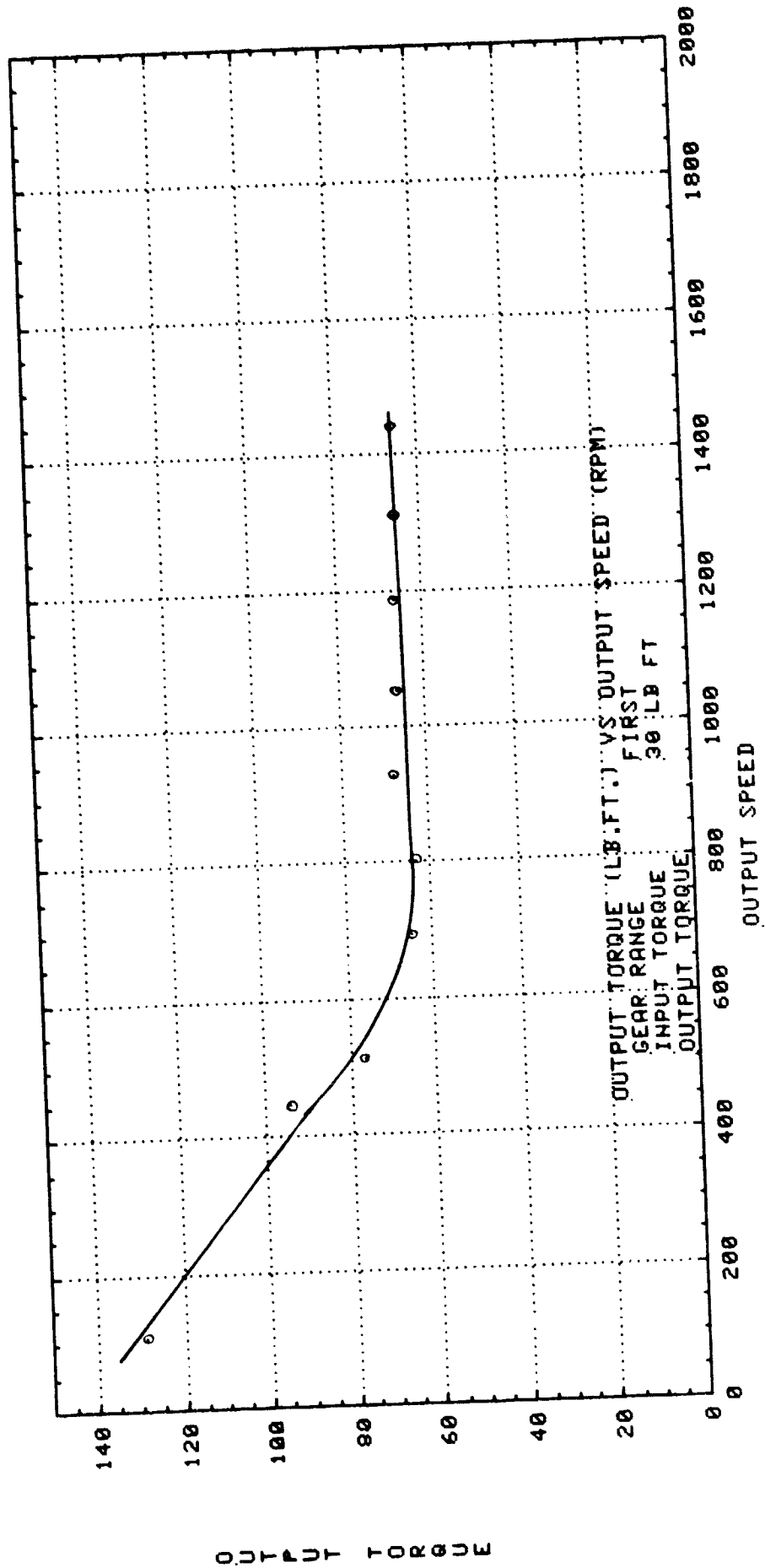

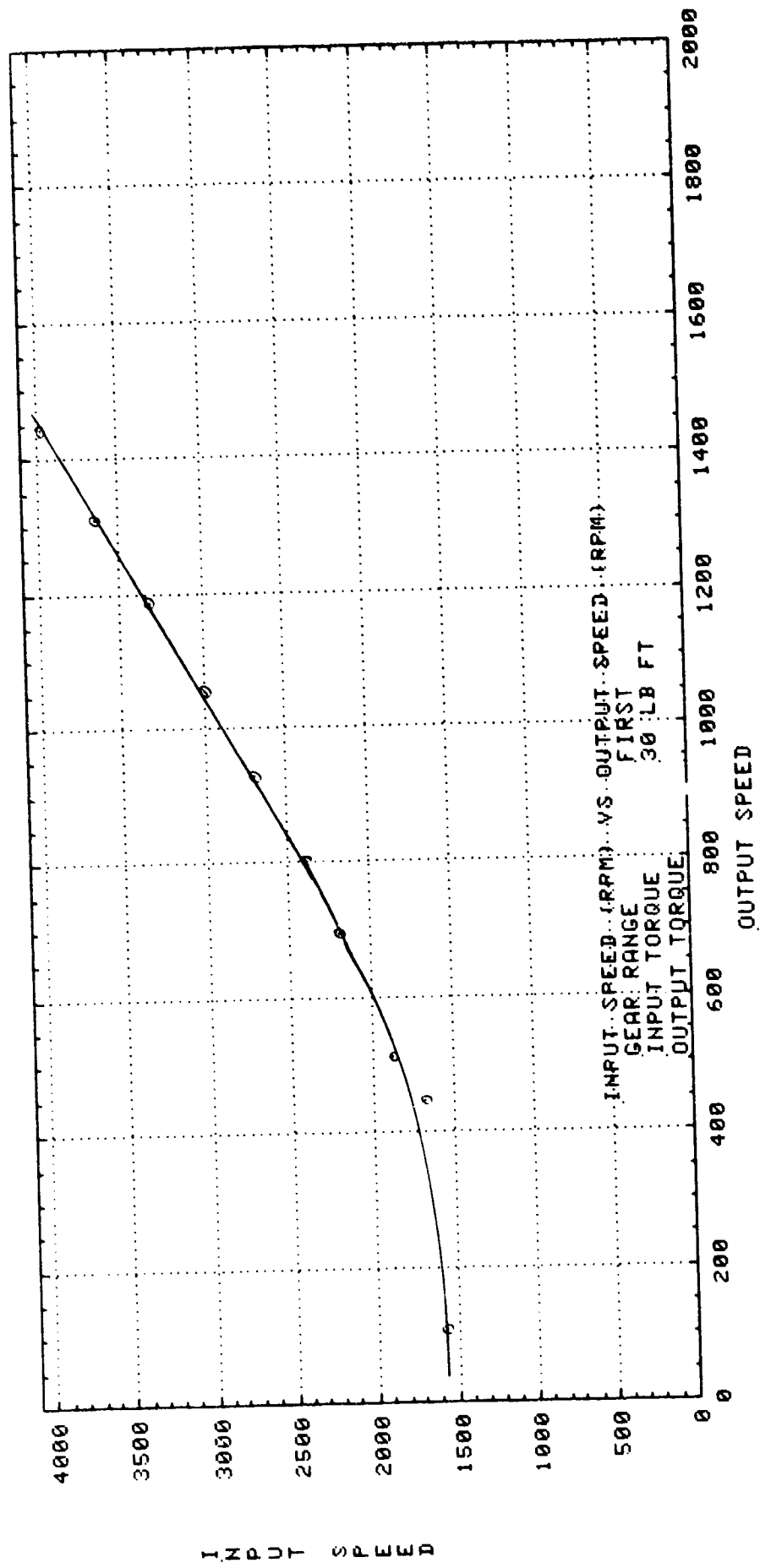

INPUT SPEED

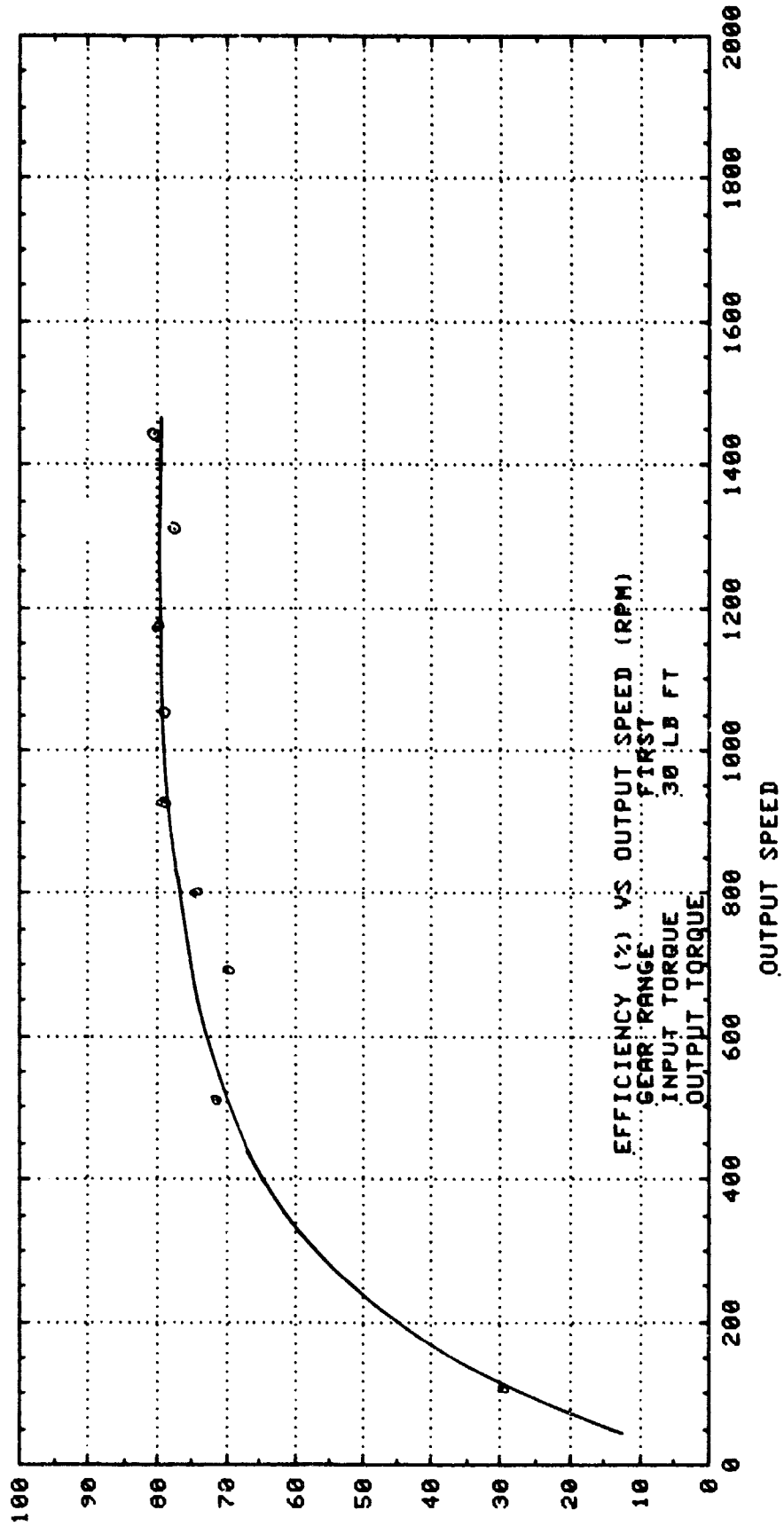

EFFICIENCY

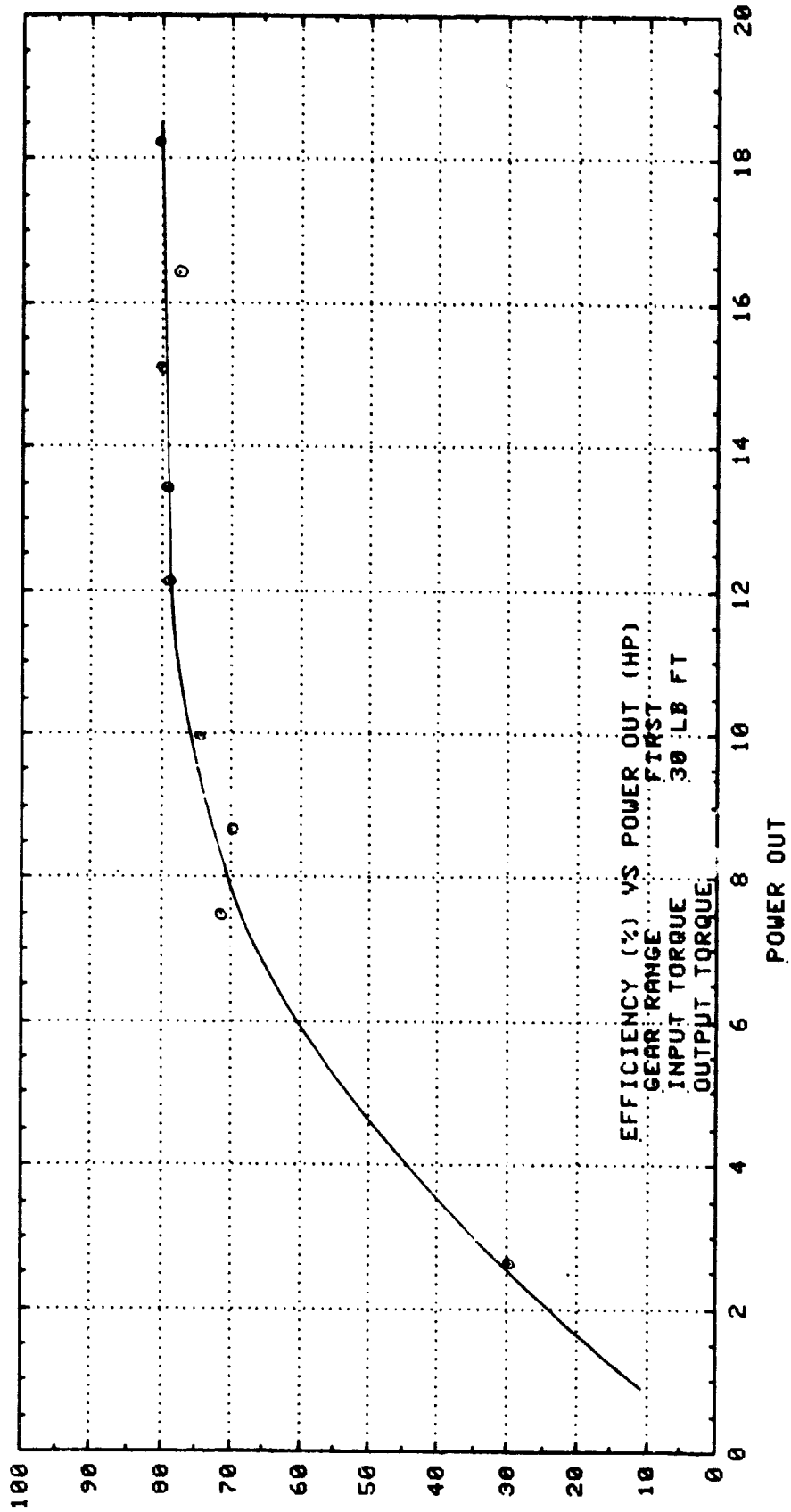

EFFICIENCY

TORQUE RATIO

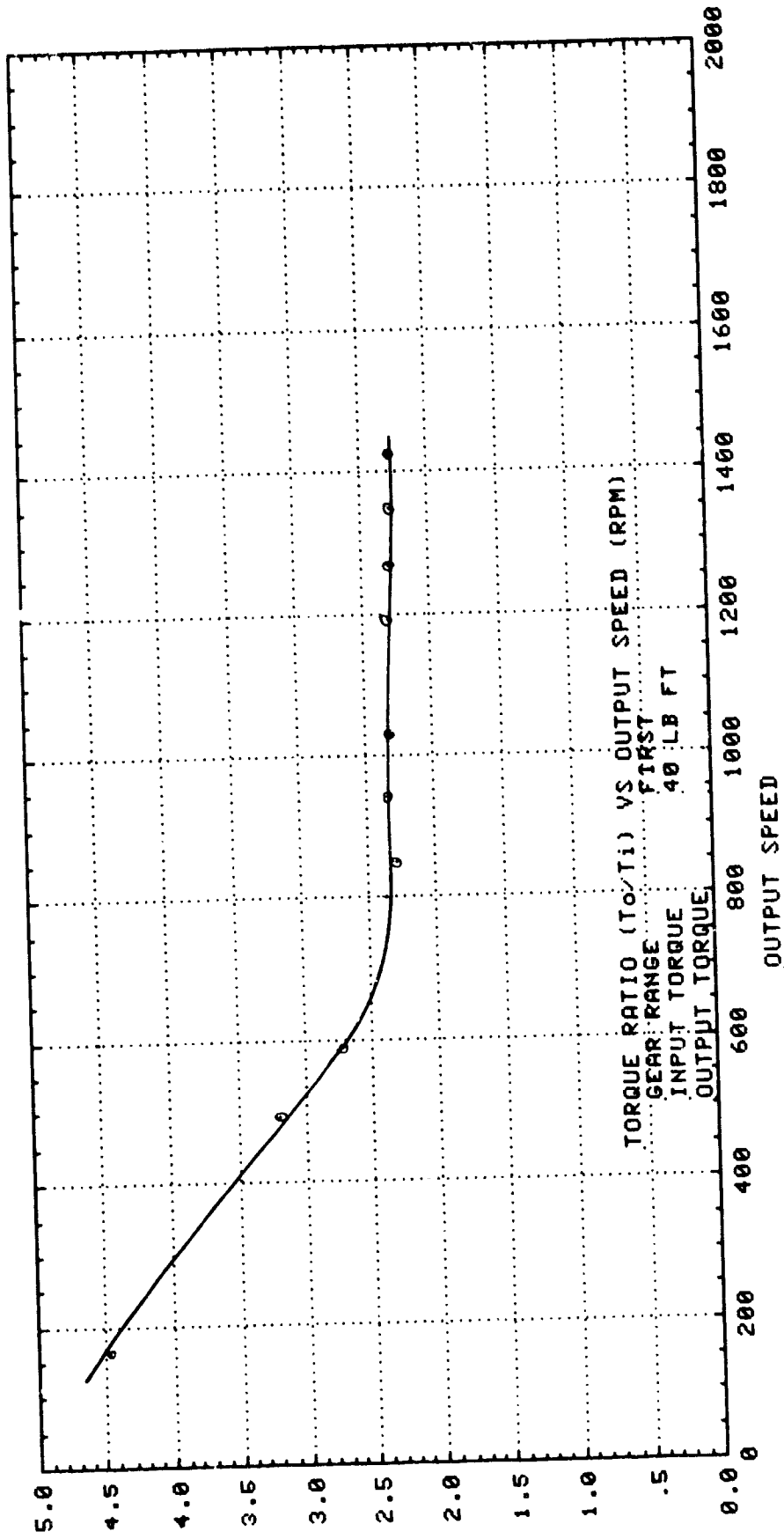



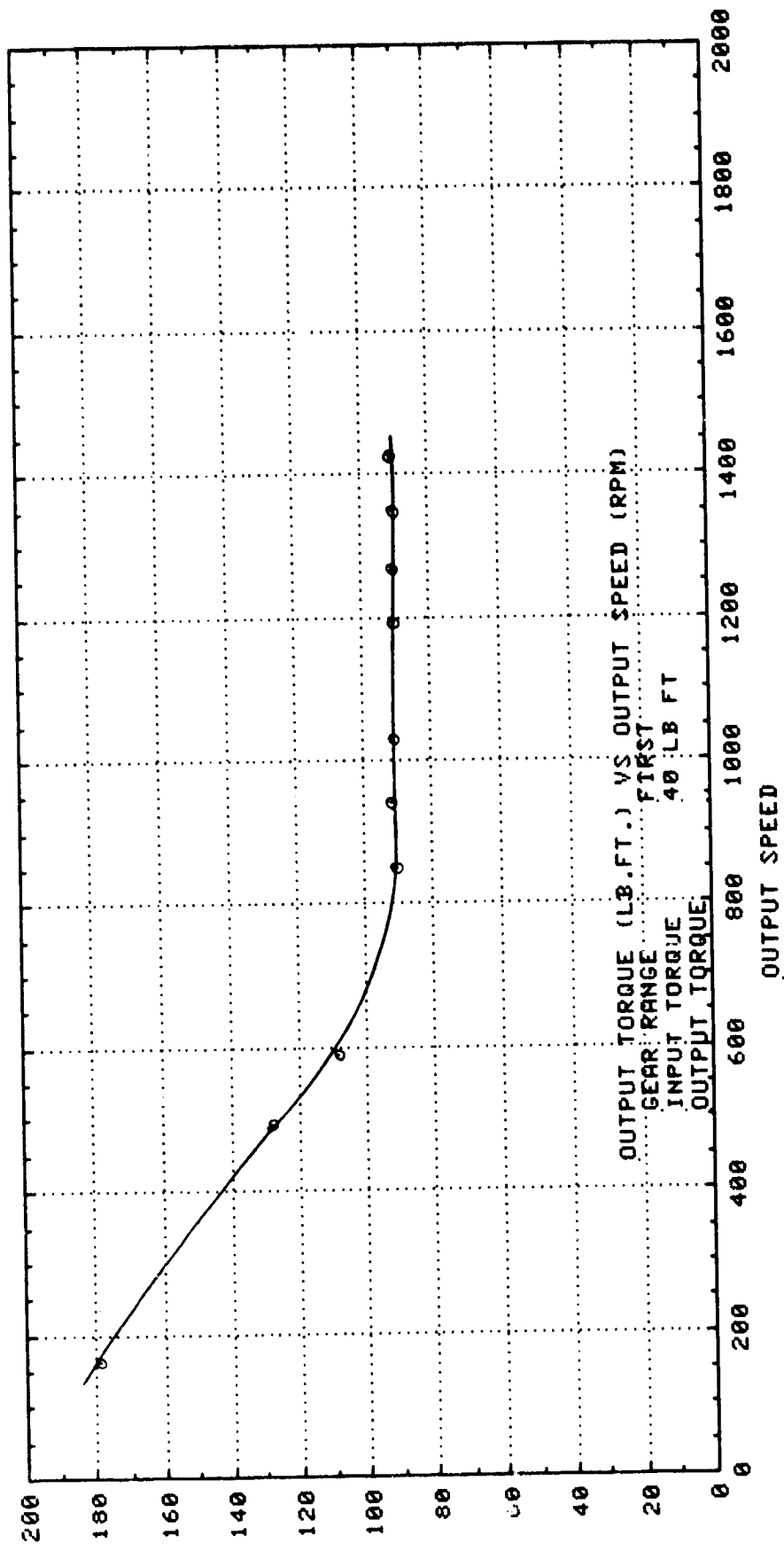

OUTPUT TORQUE

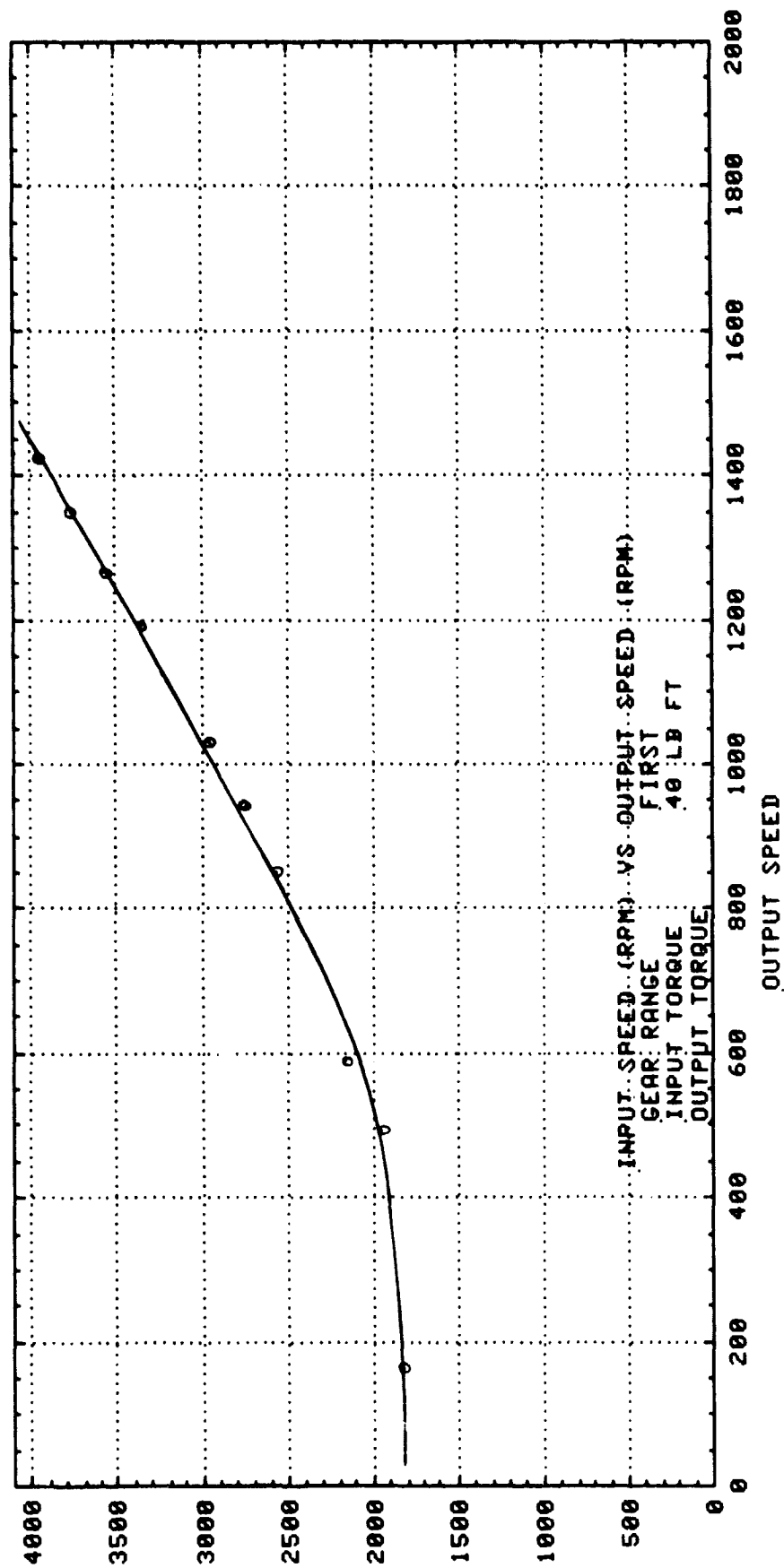

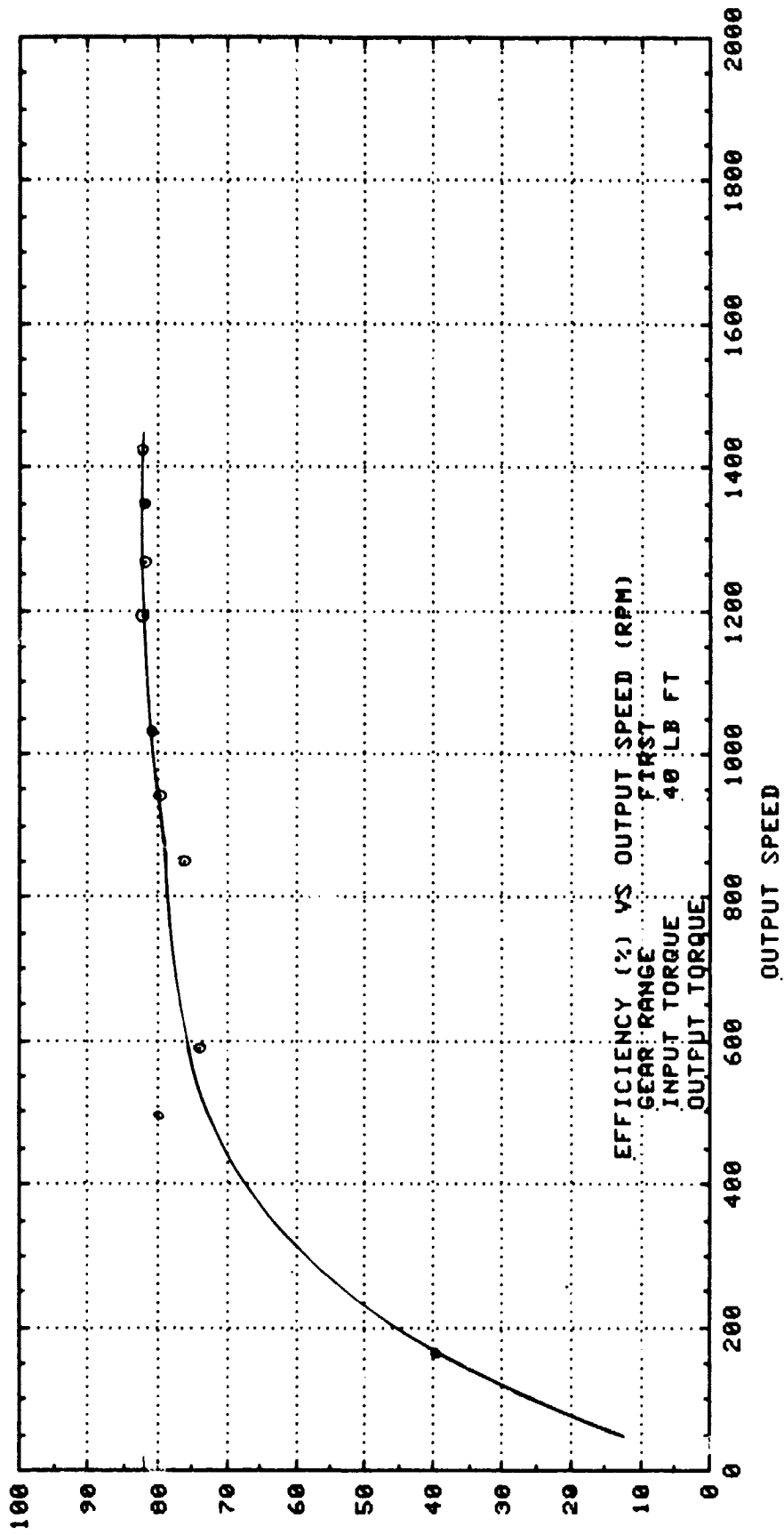

EFFICIENCY

E F F I C I E N C Y

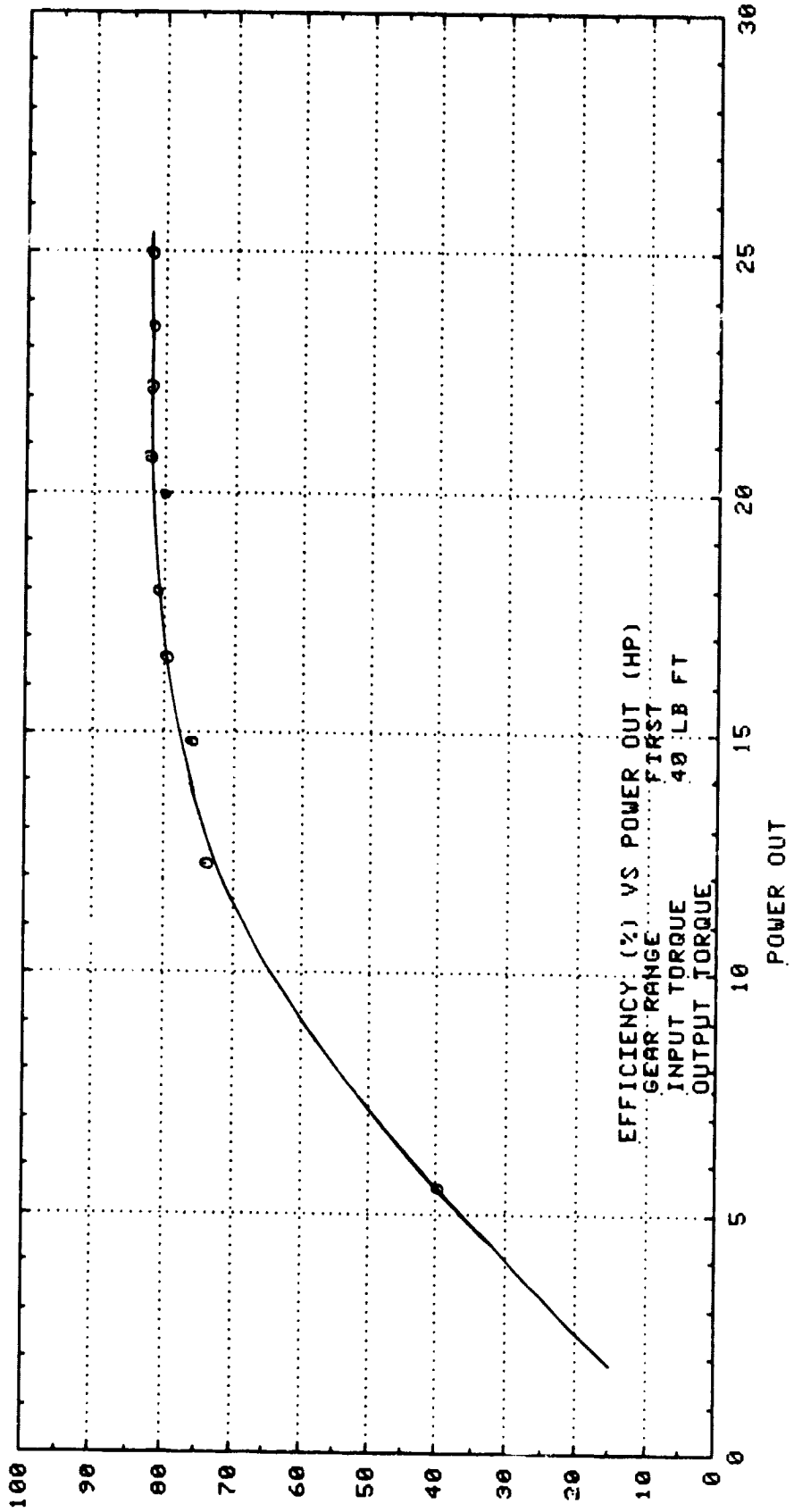

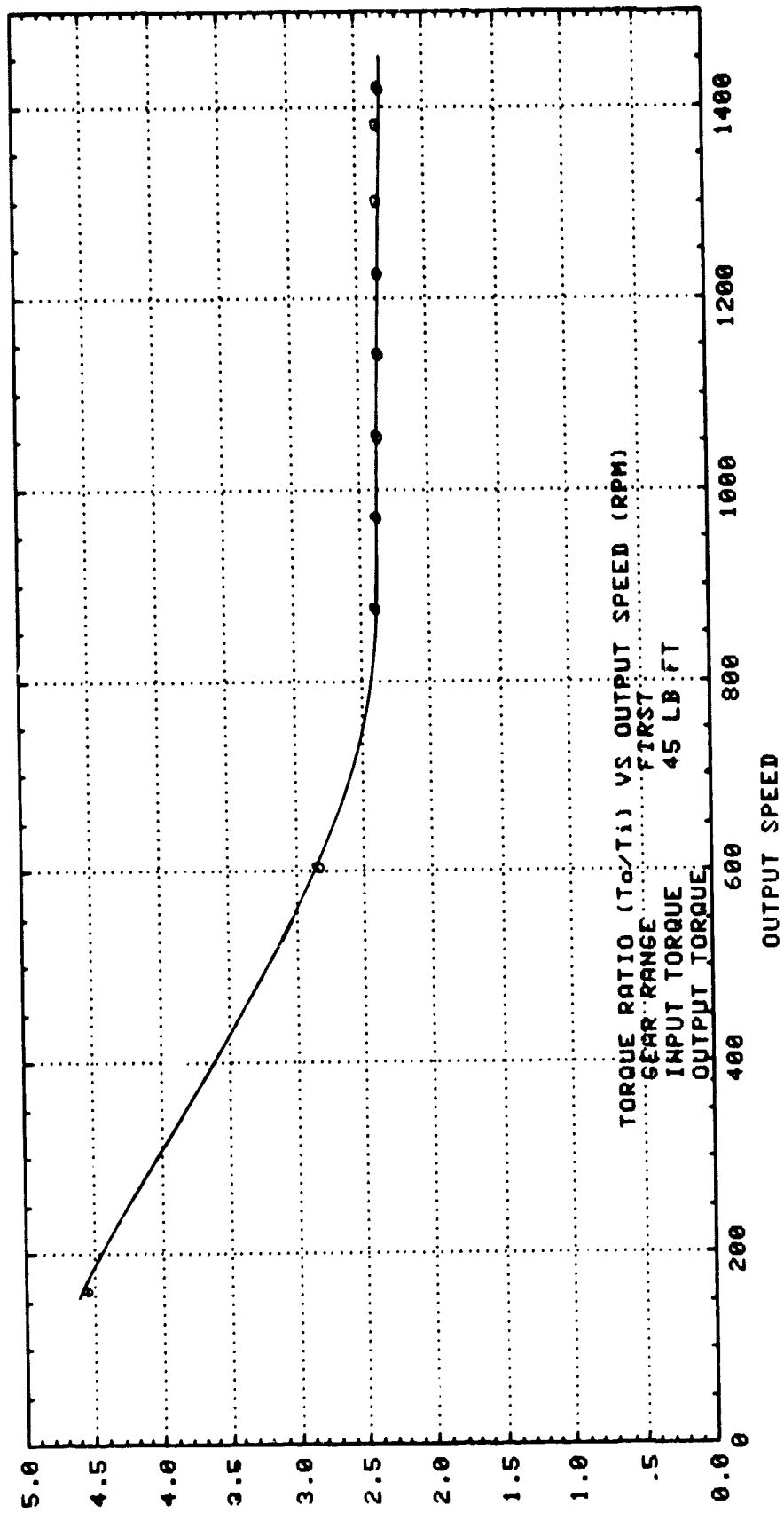

TORQUE RATIO

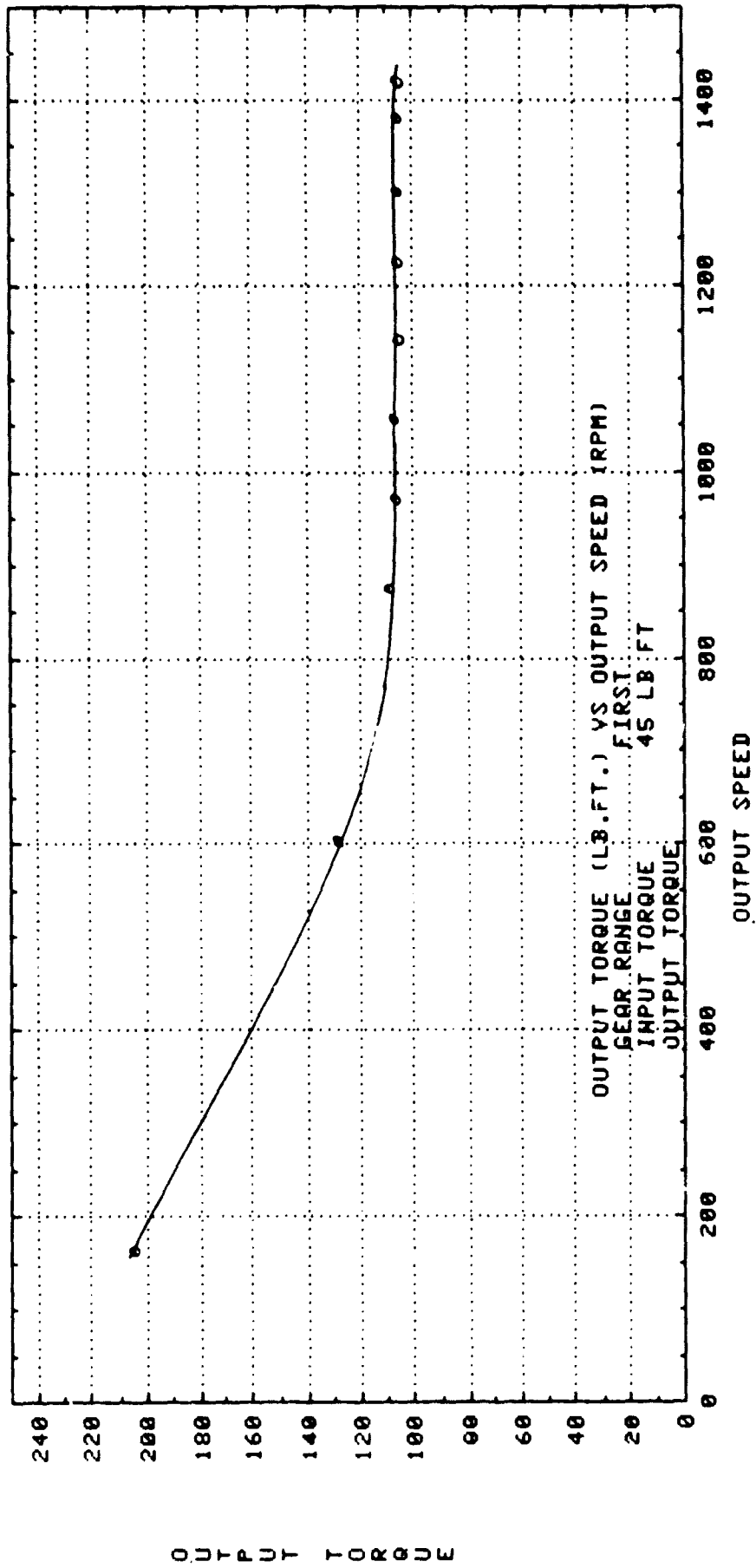

OUTPUT TORQUE

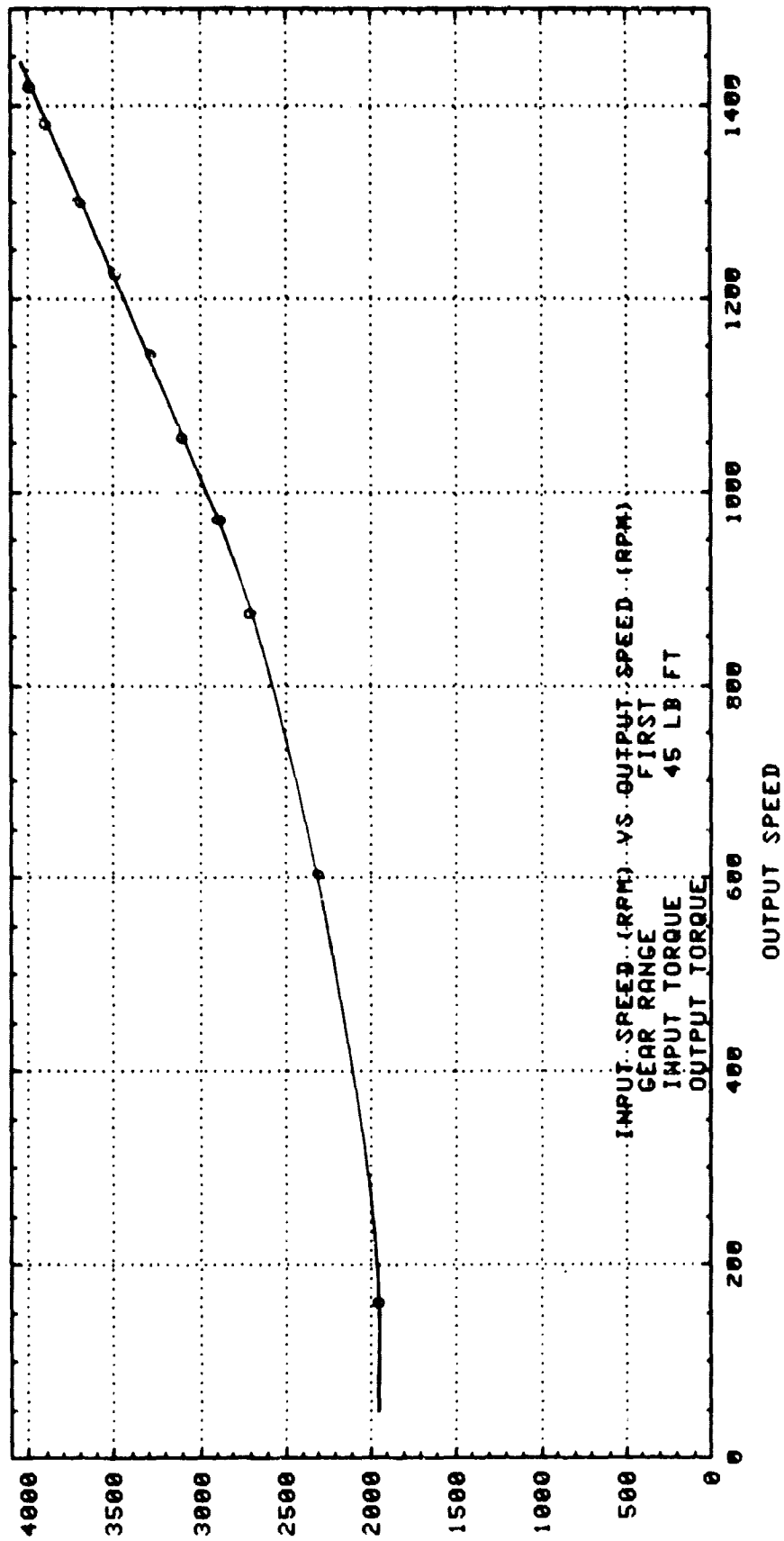

INPUT SPEED

EFFICIENCY

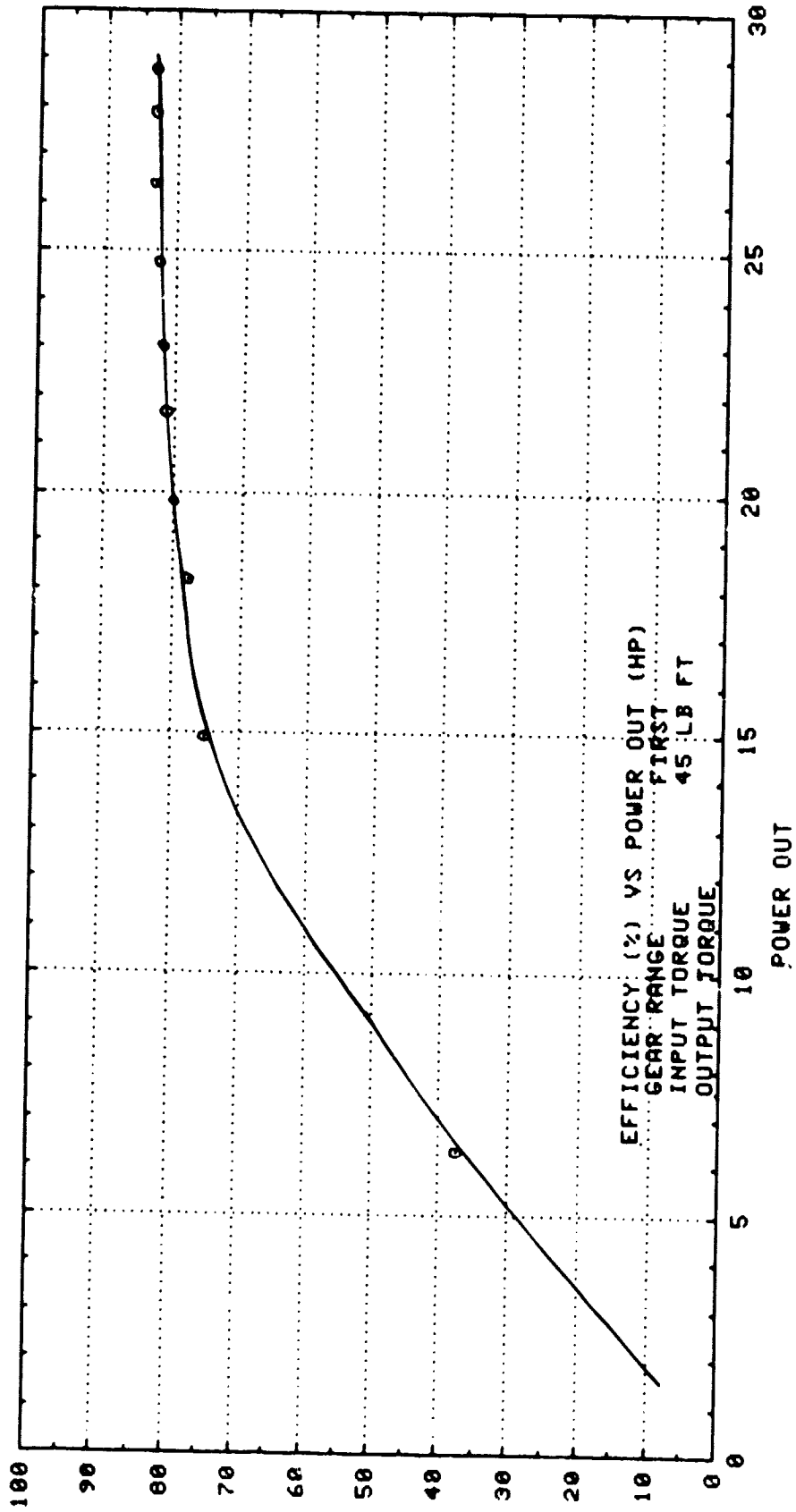



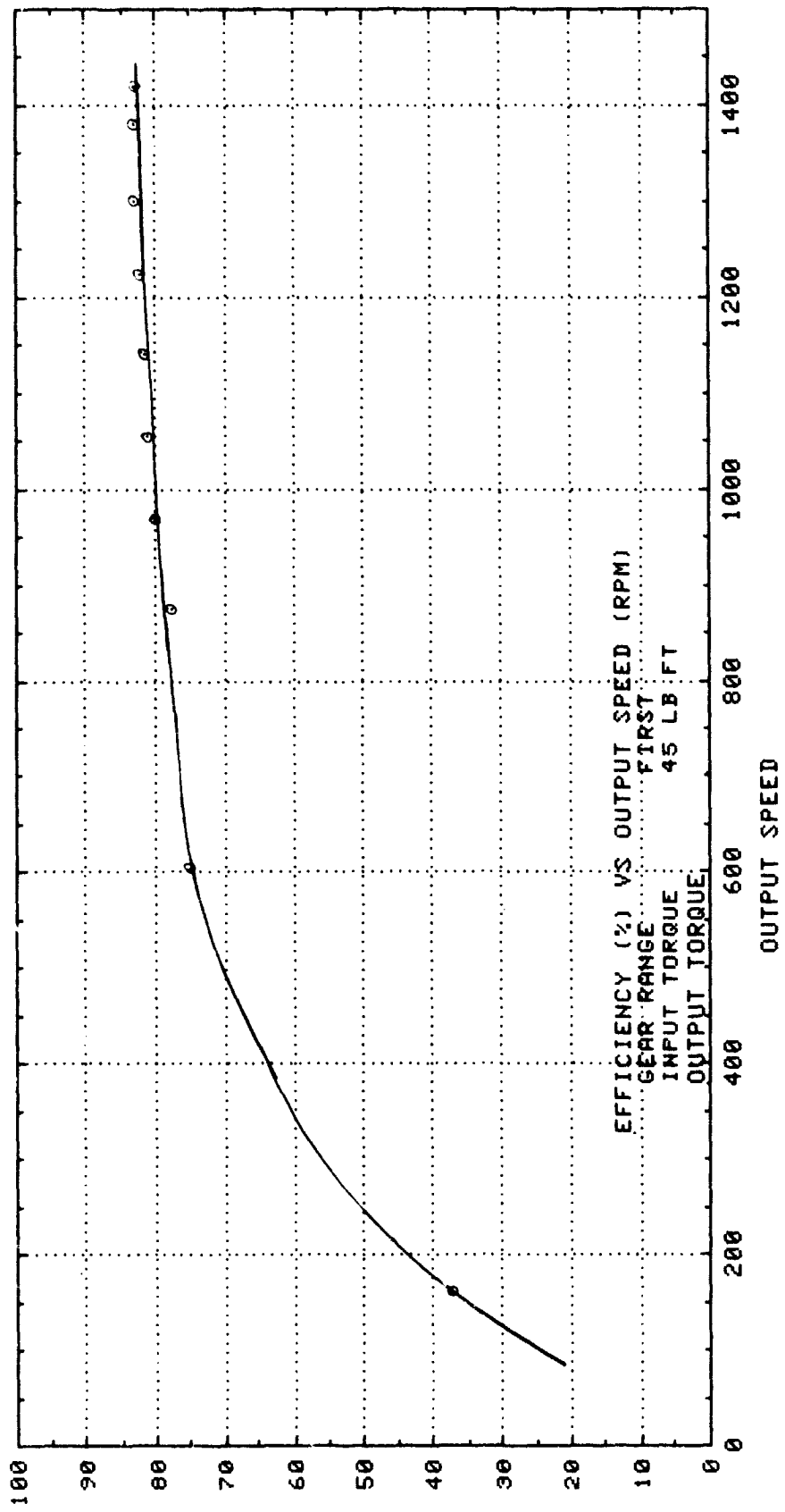

EFFICIENCY

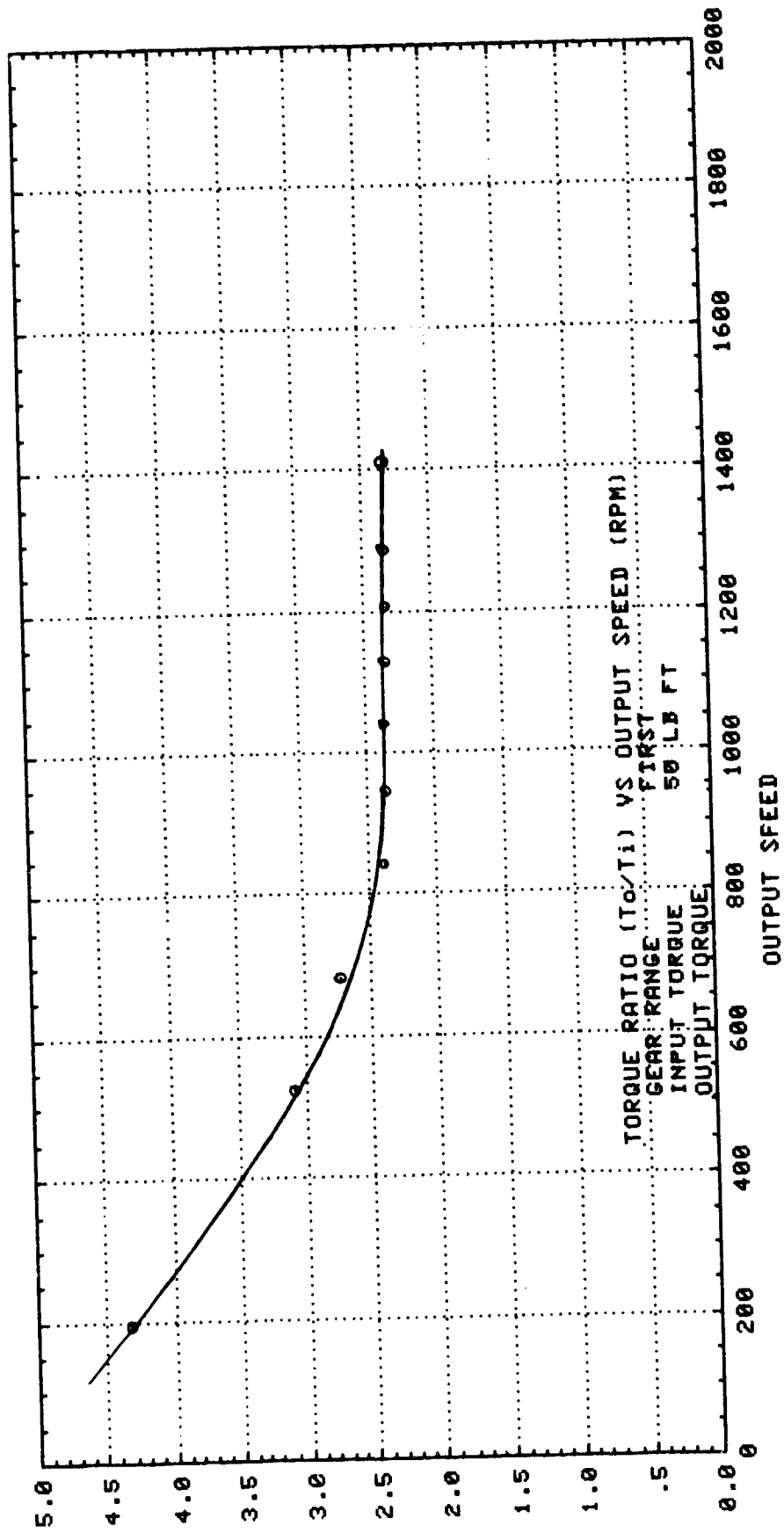

TORQUE RATIO

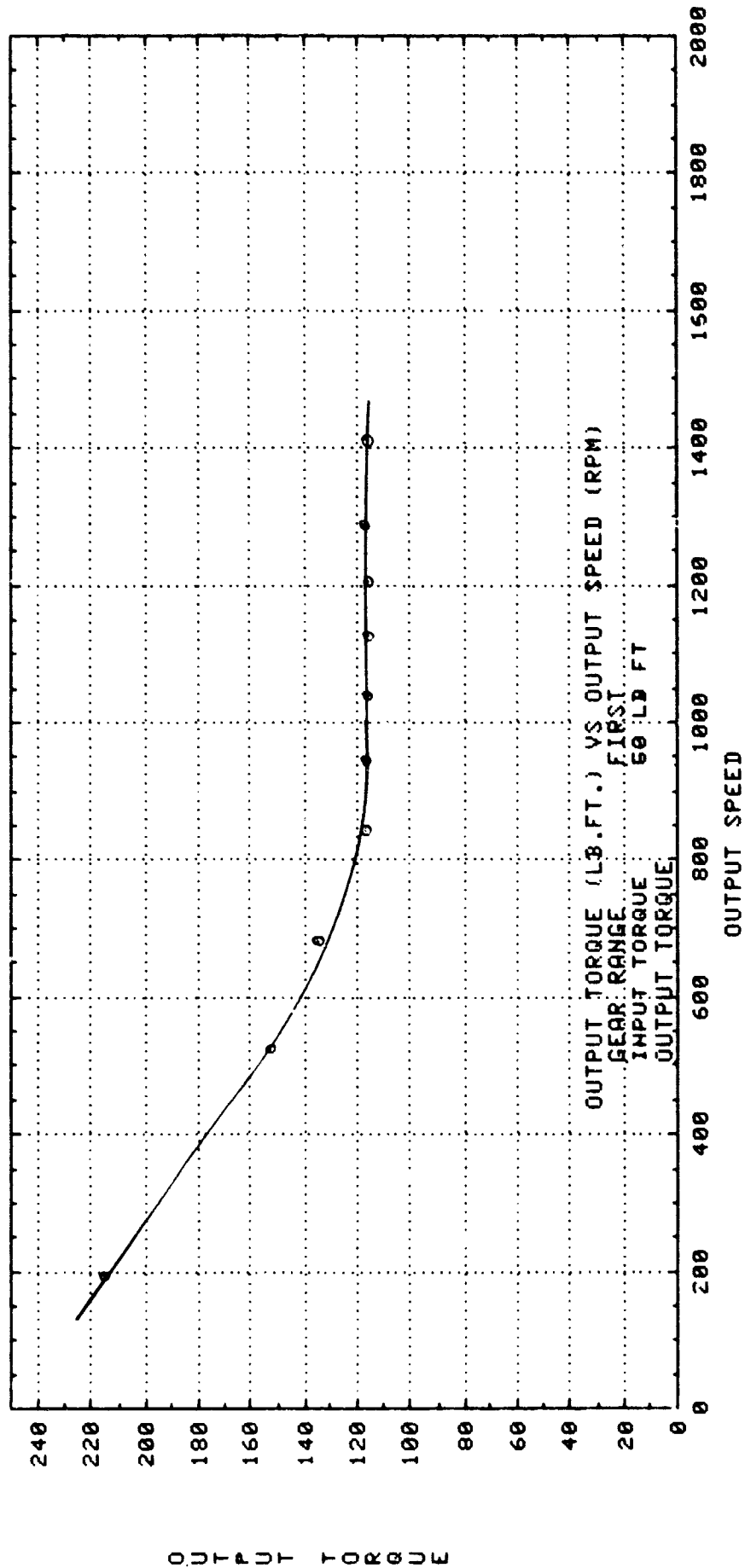

OUTPUT TORQUE

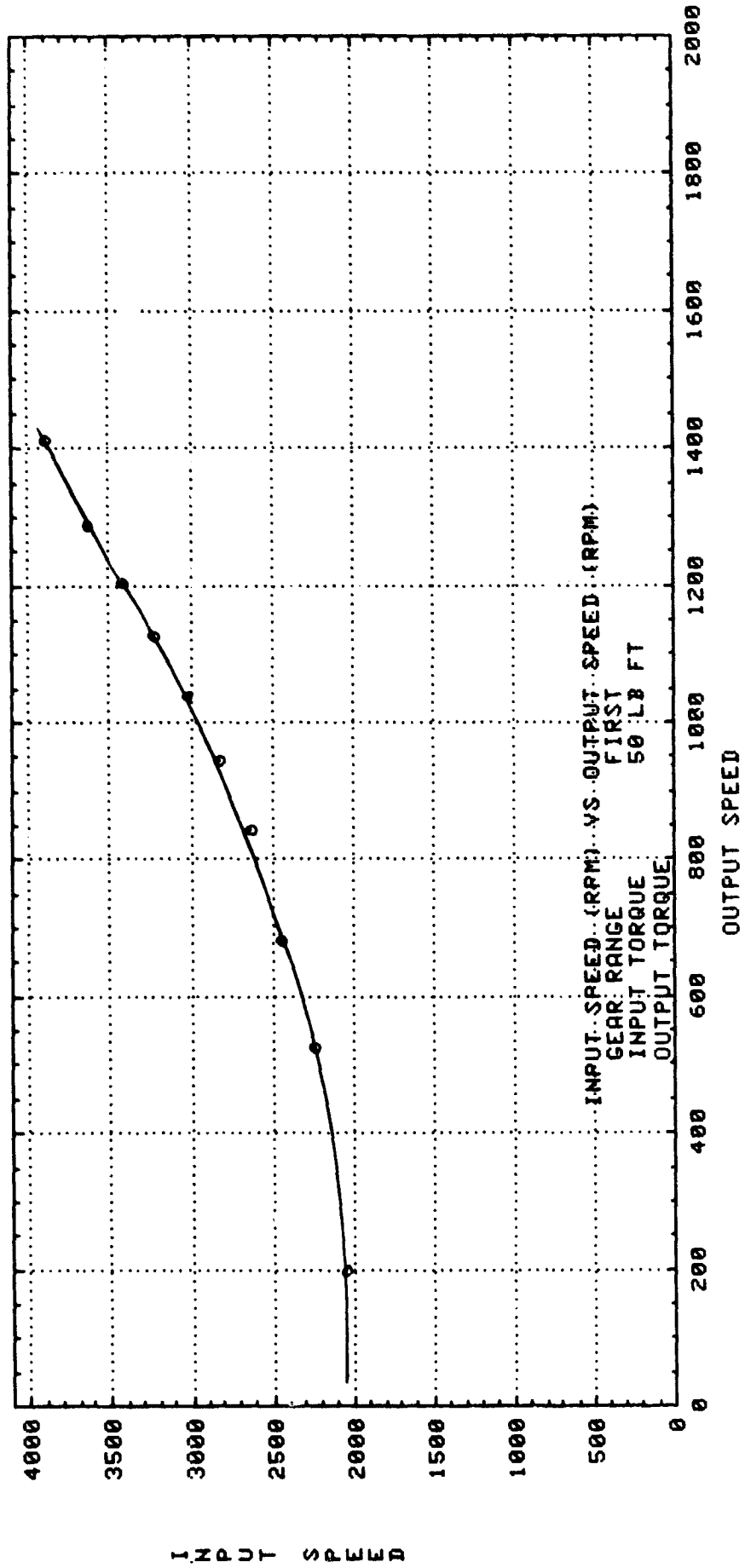

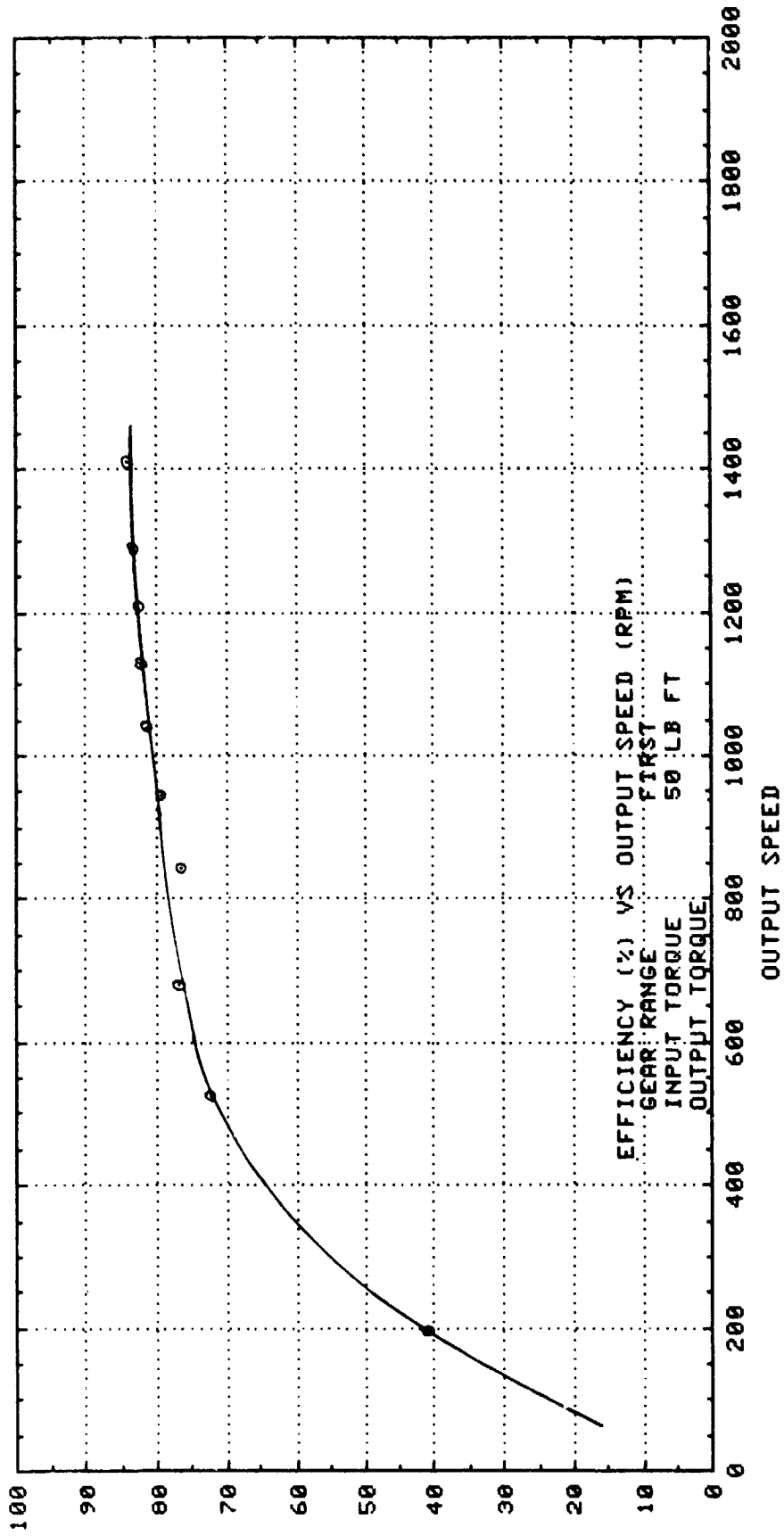

EFFICIENCY

EFFICIENCY

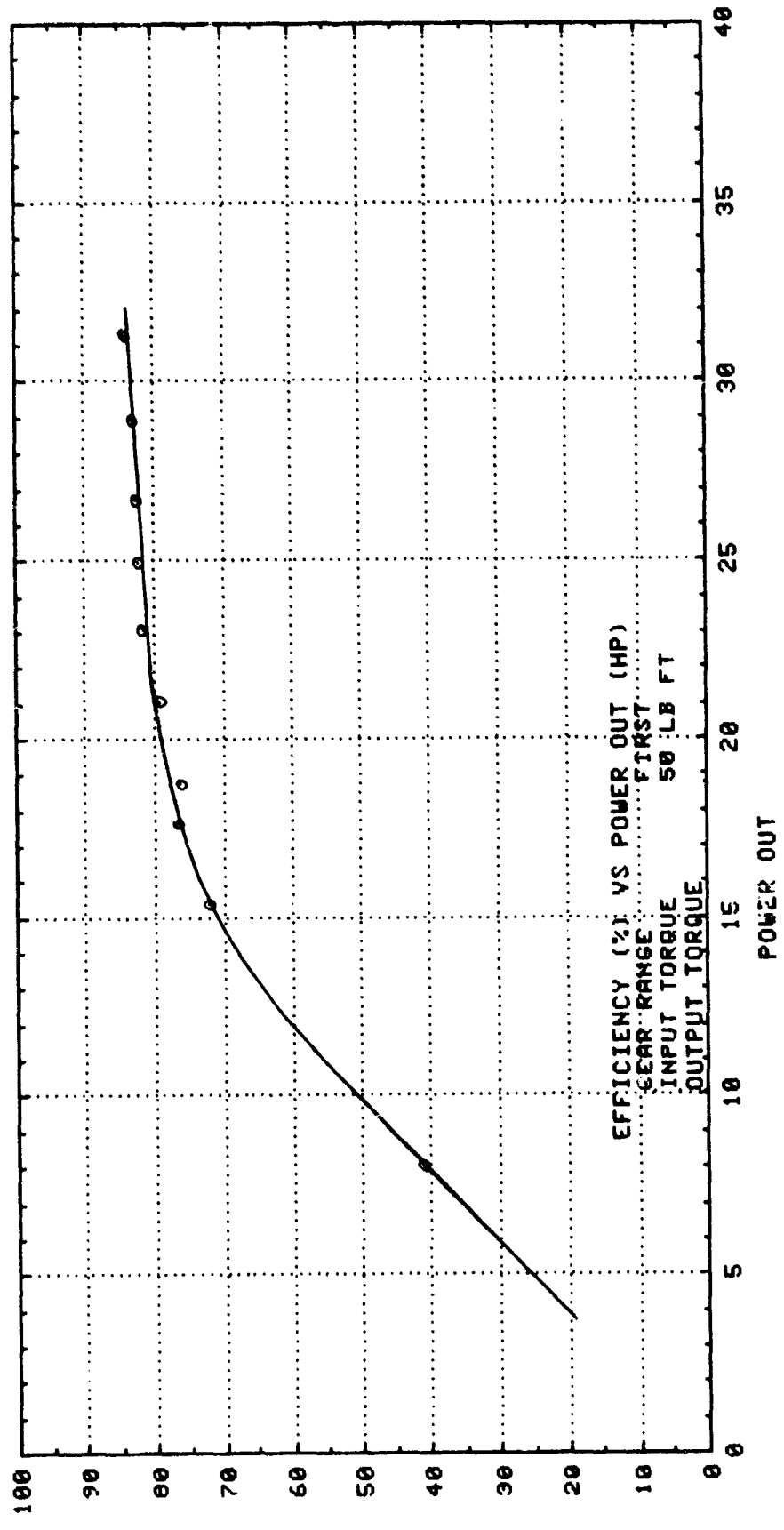

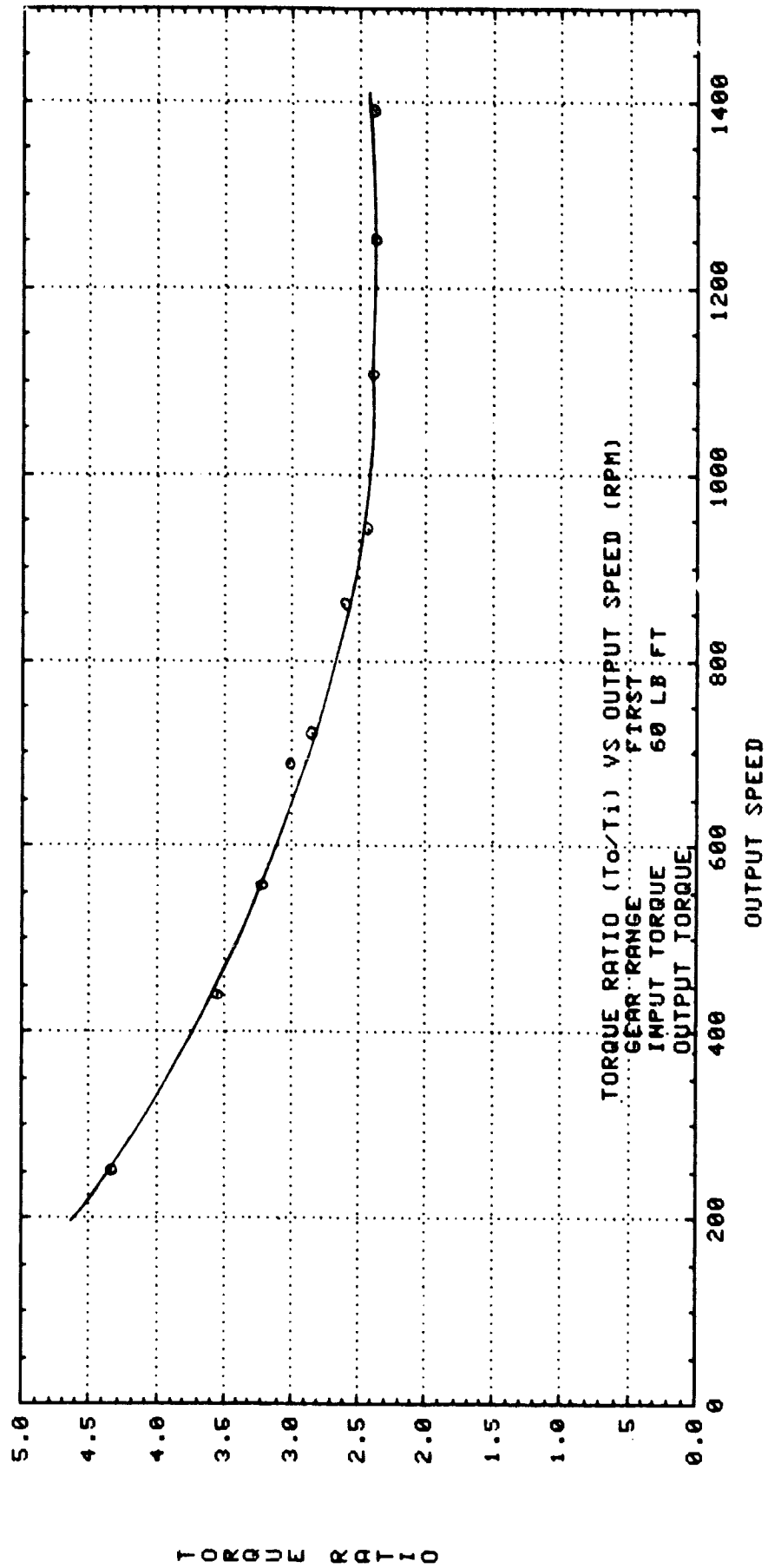

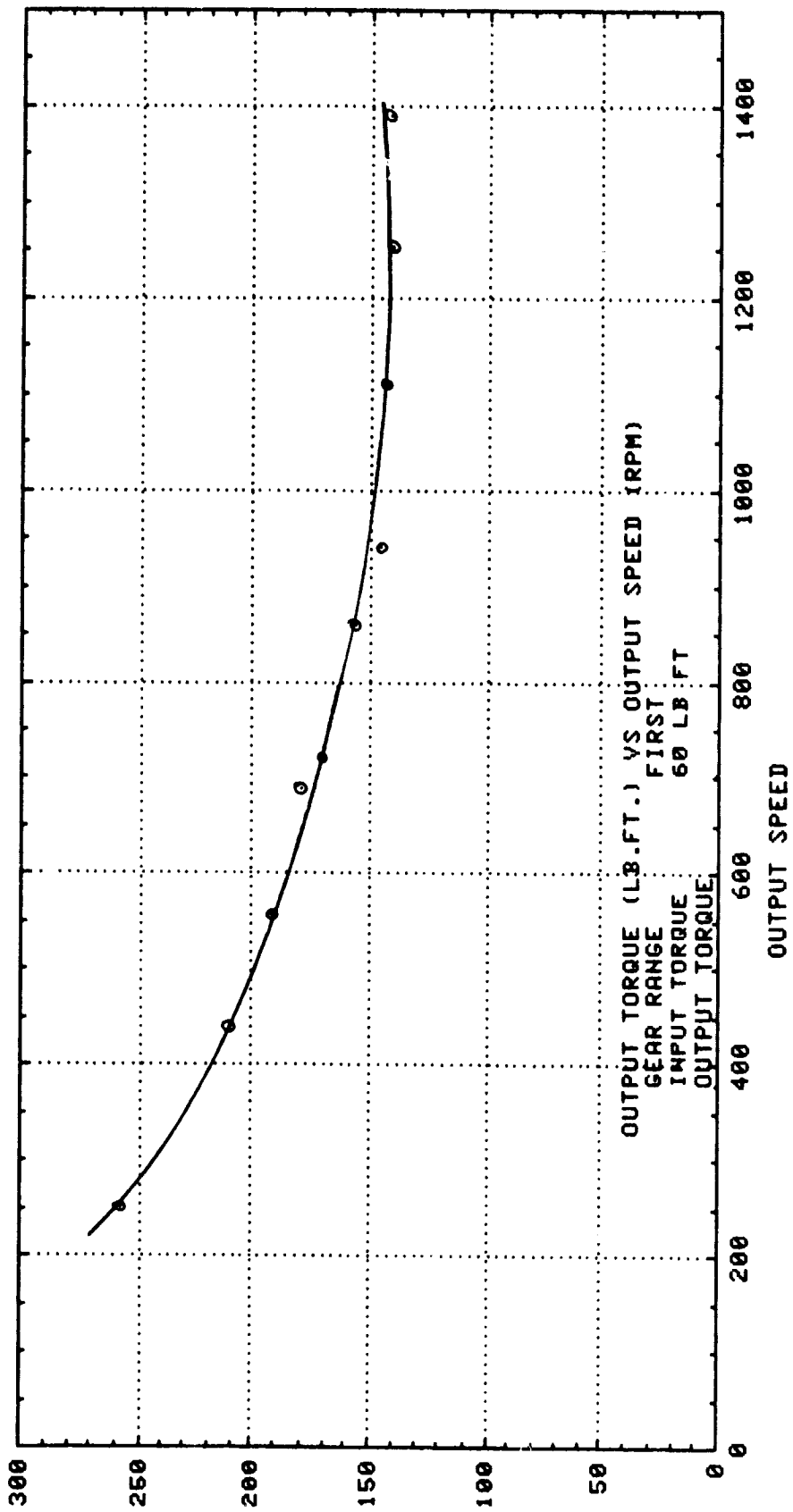



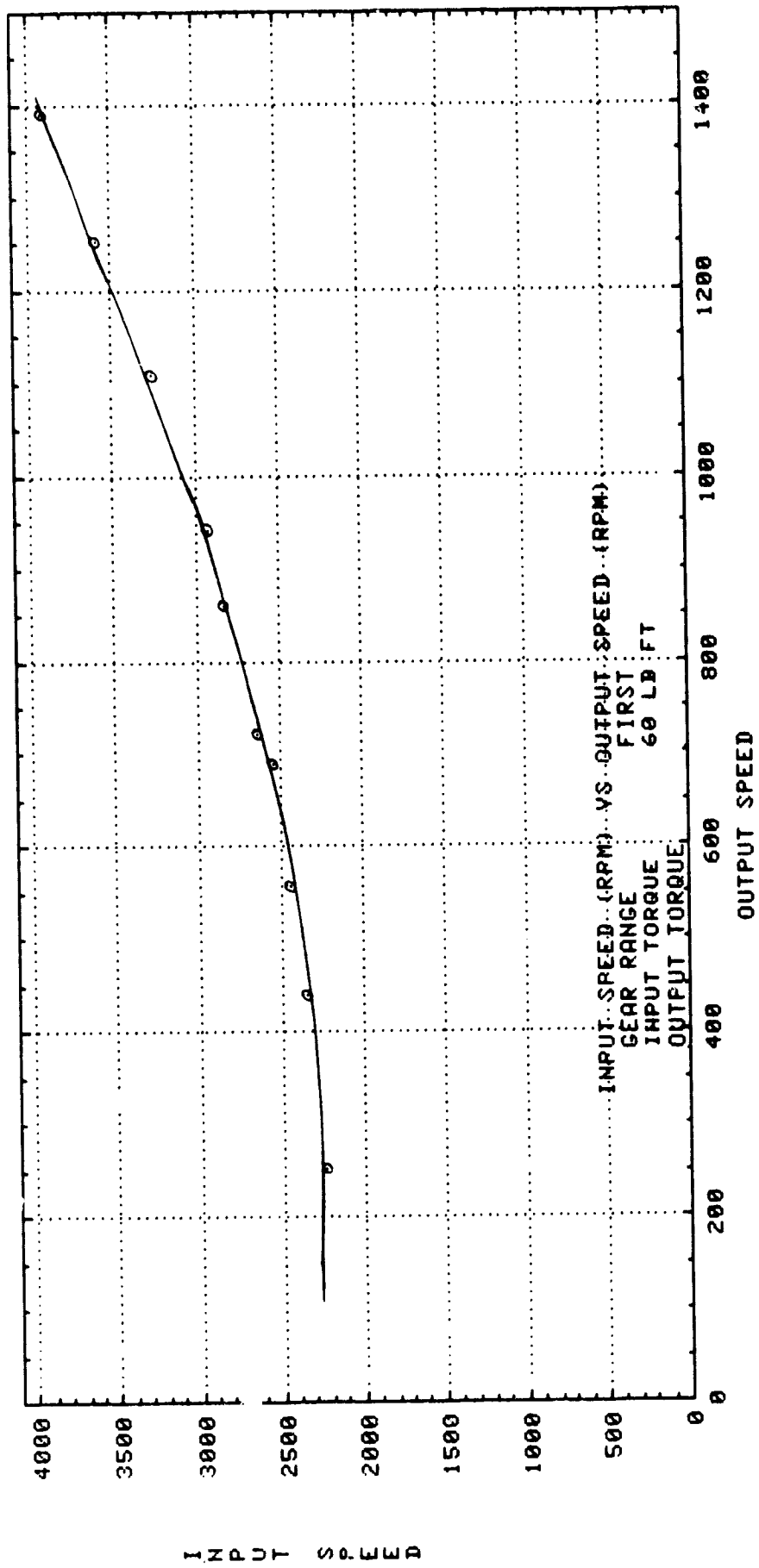

EFFICIENCY

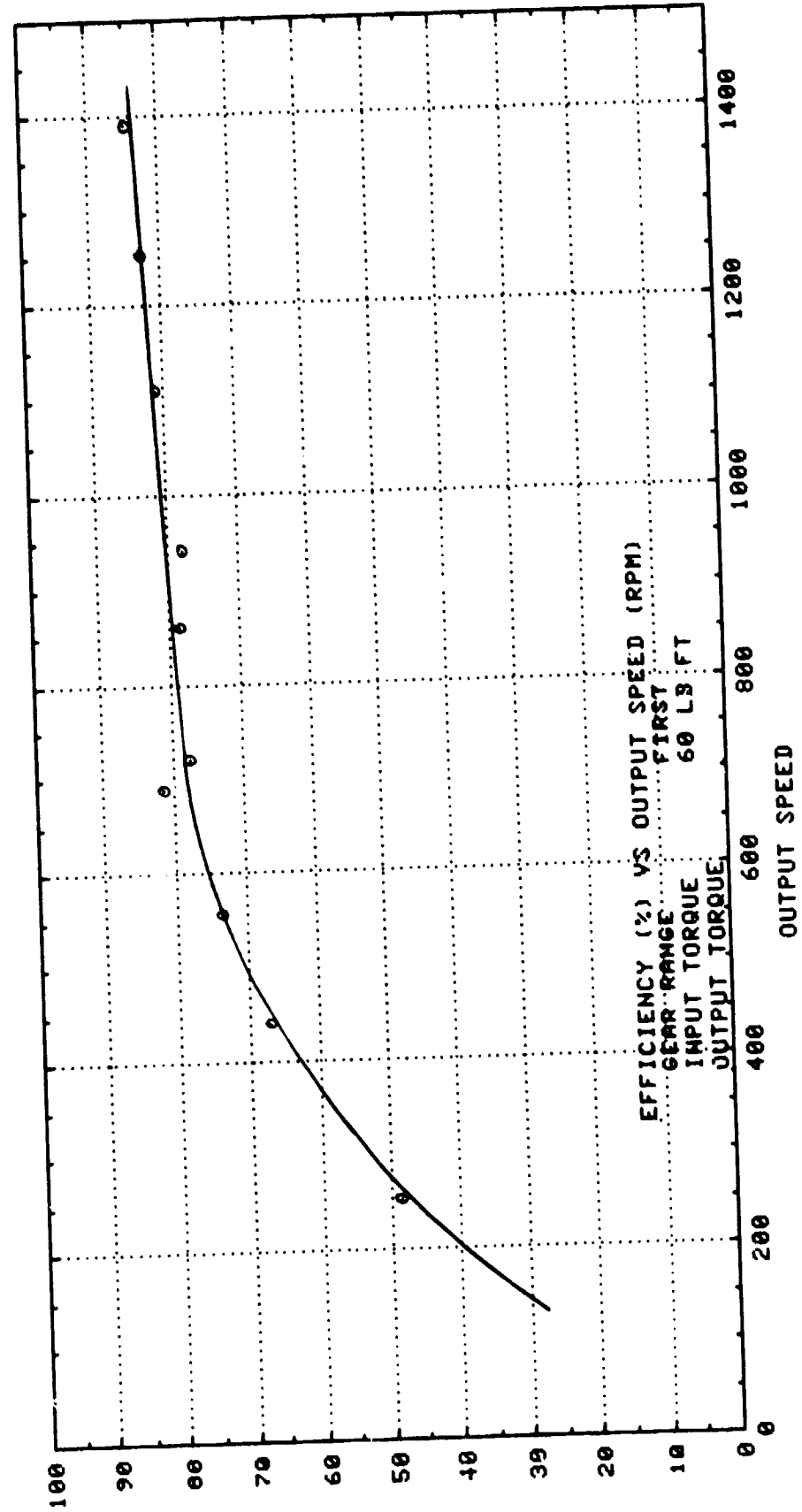

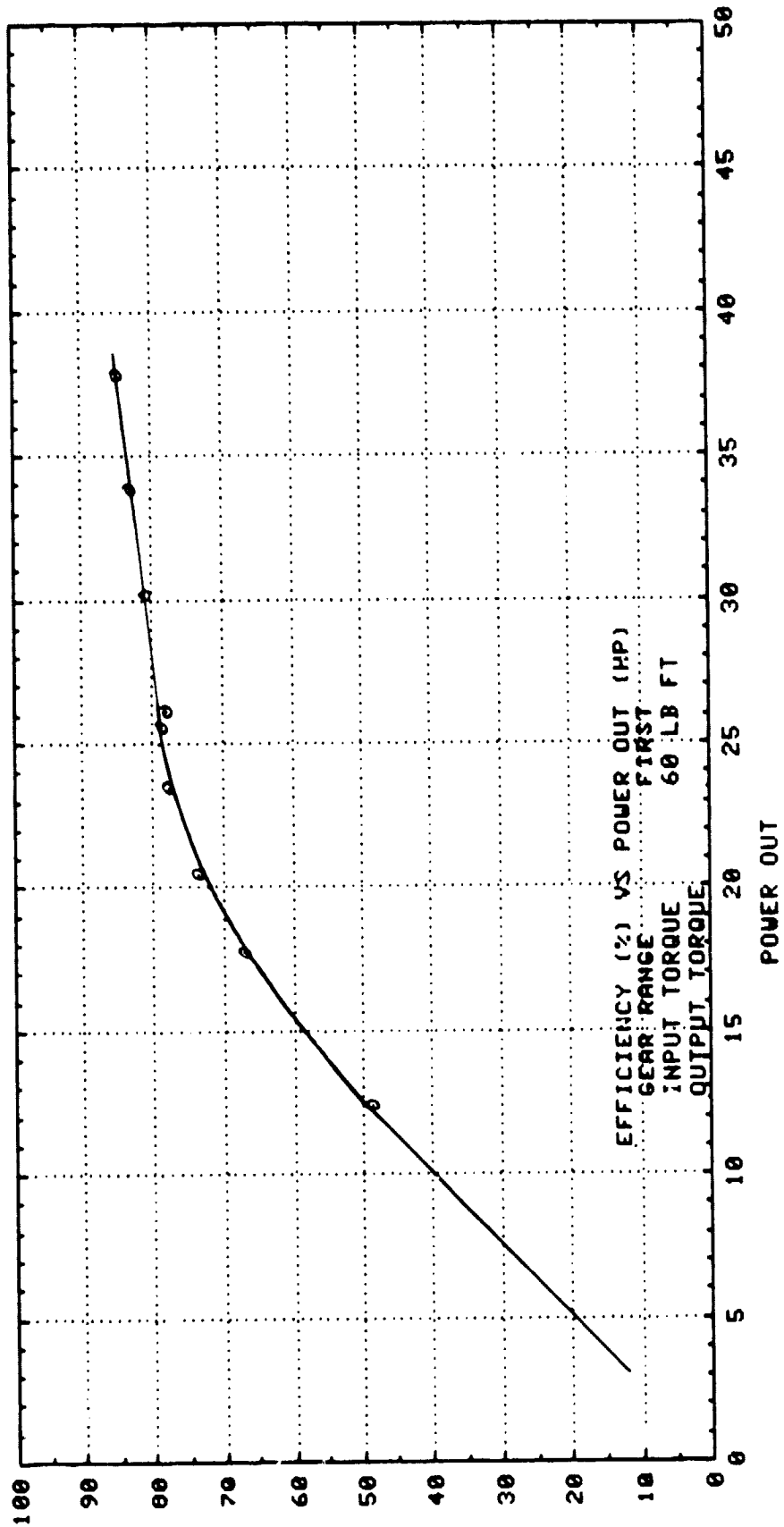

EFFICIENCY

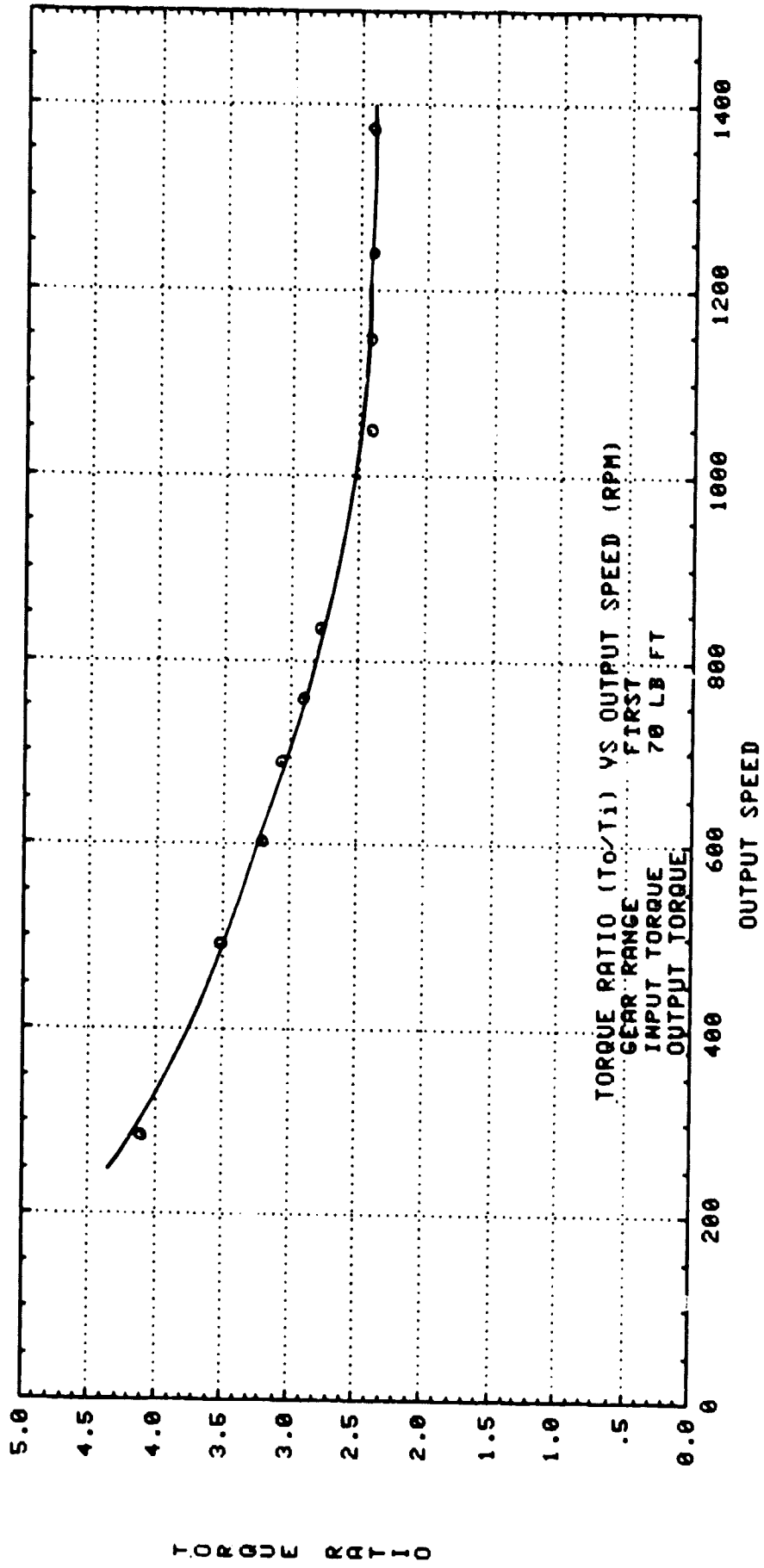

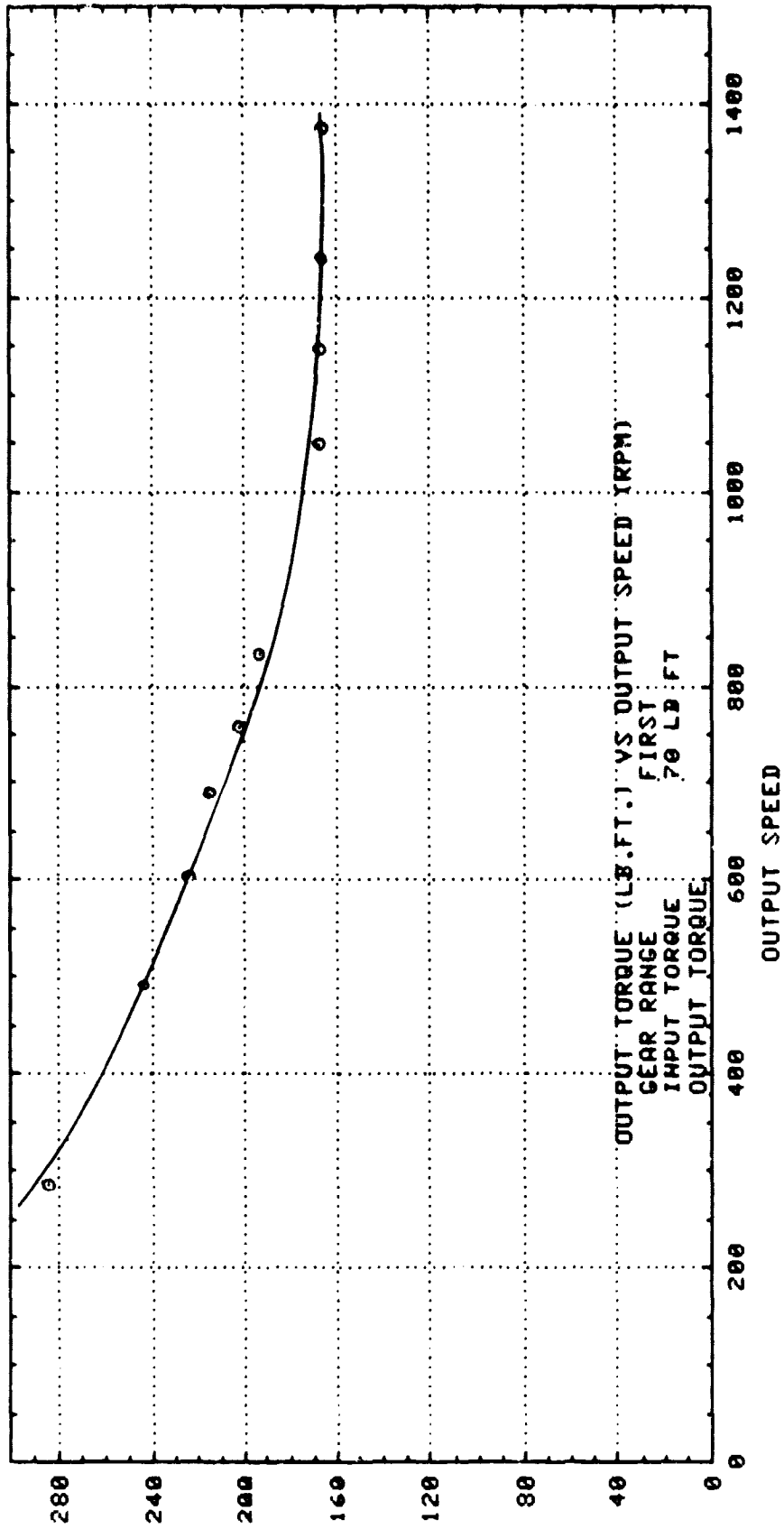

OUTPUT TORQUE

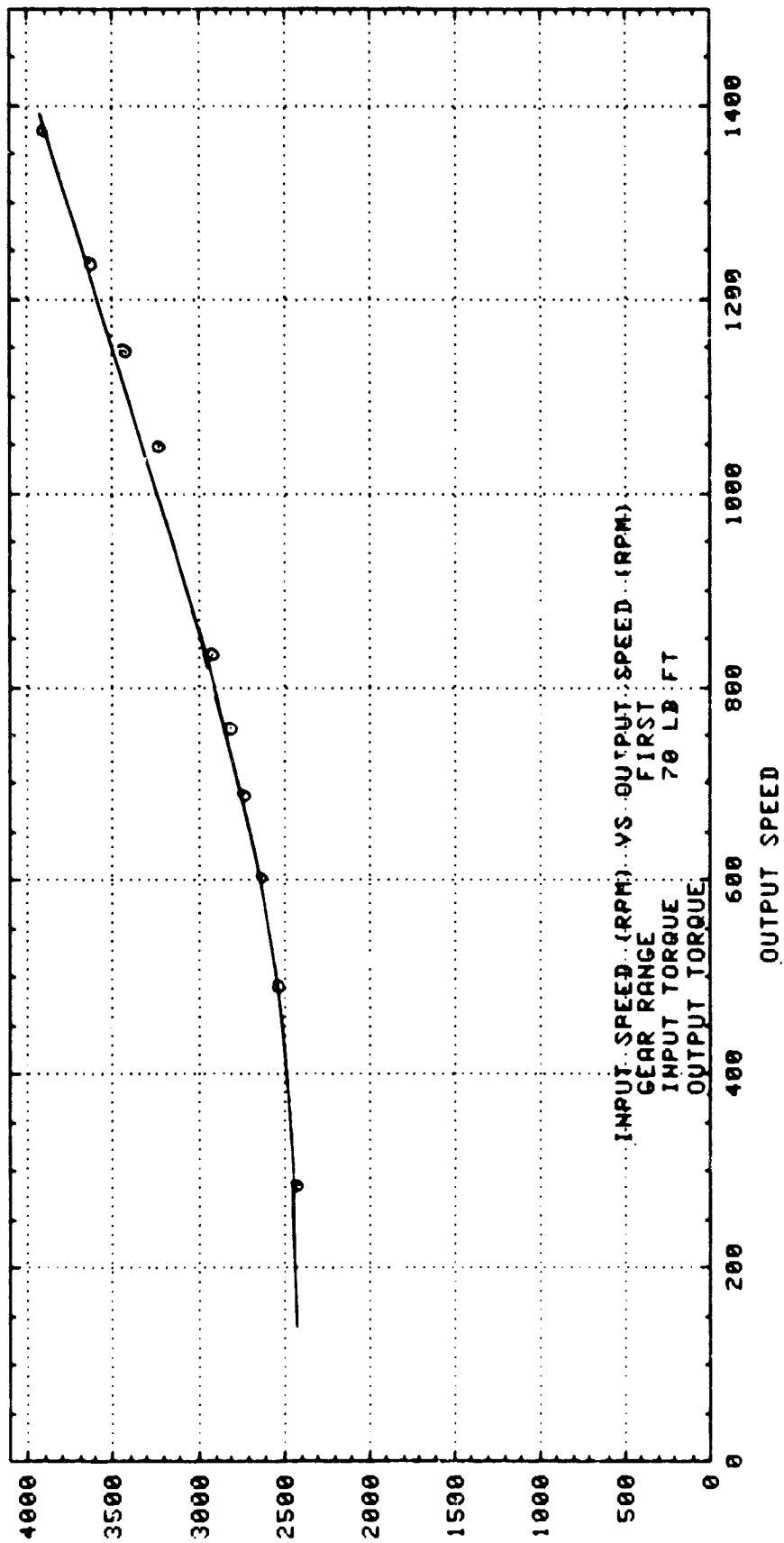

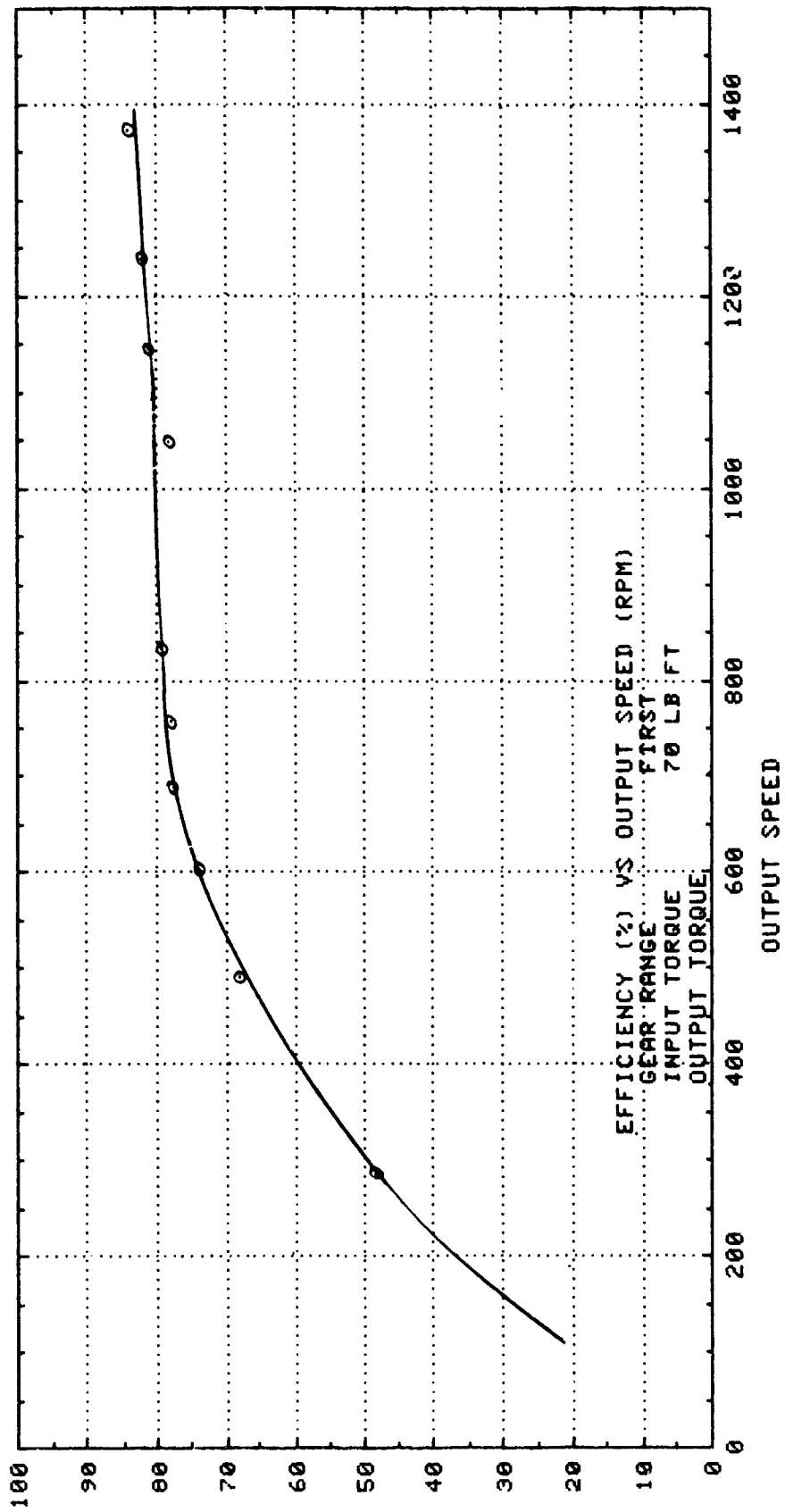

EFFICIENCY

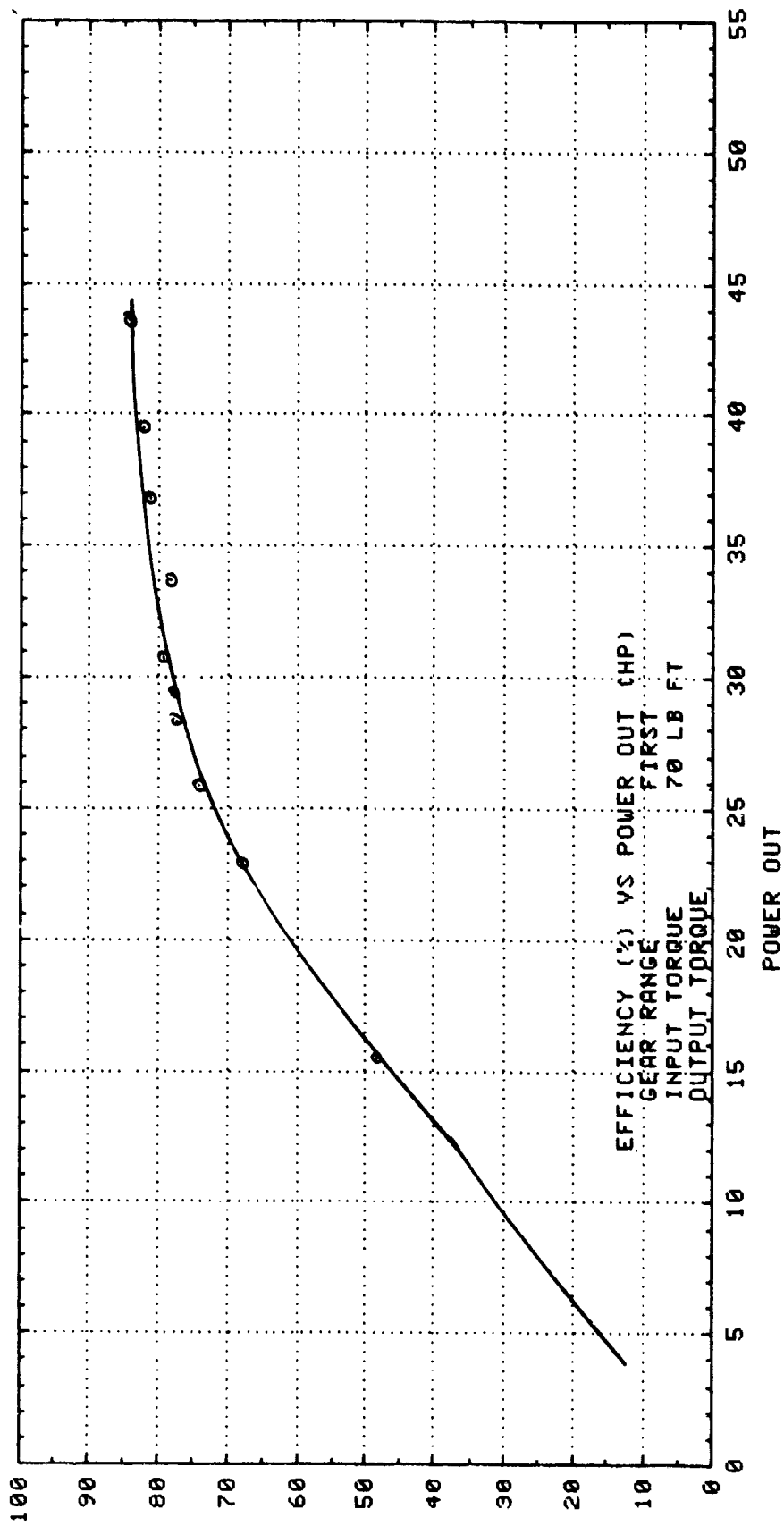



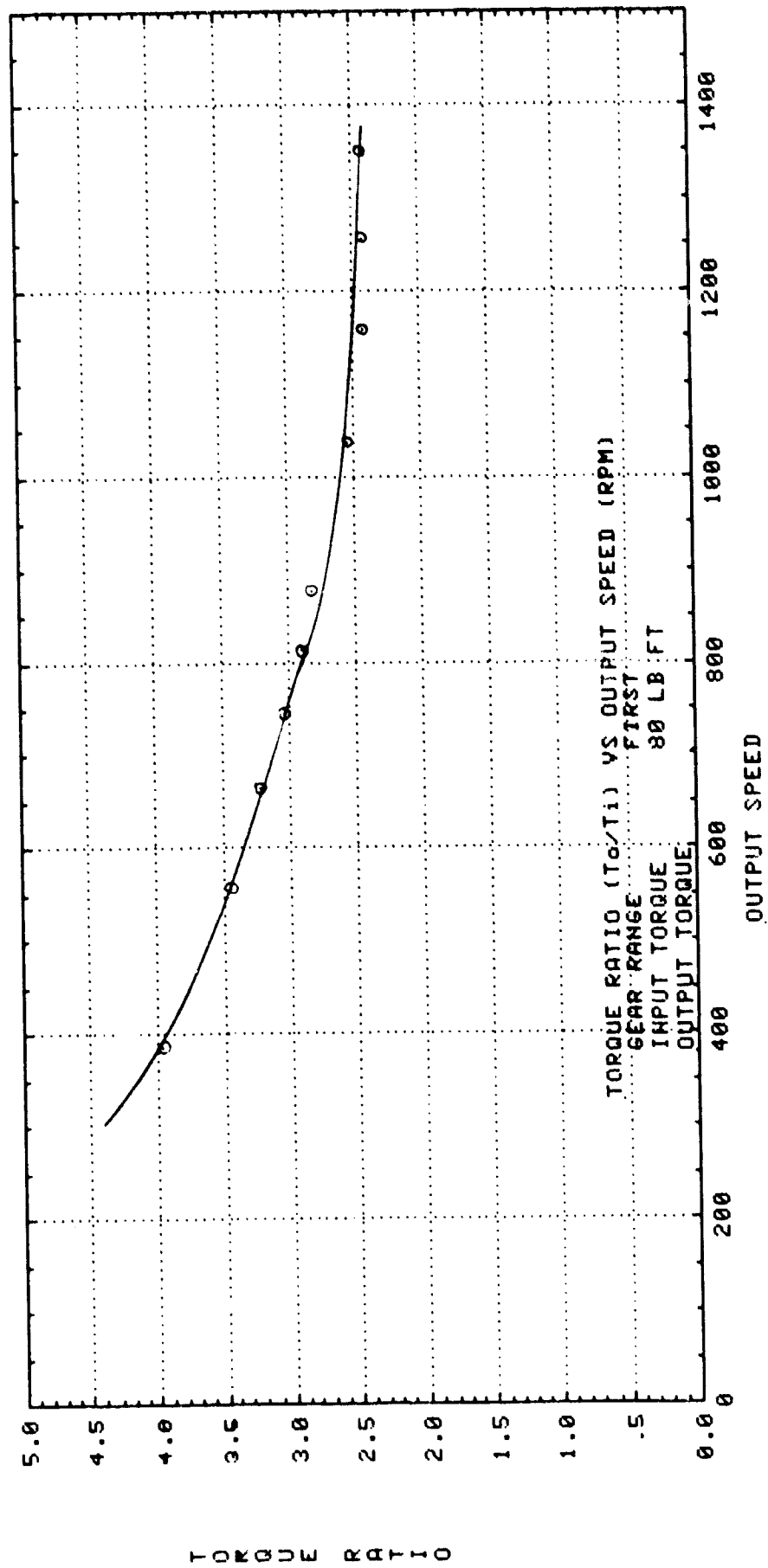

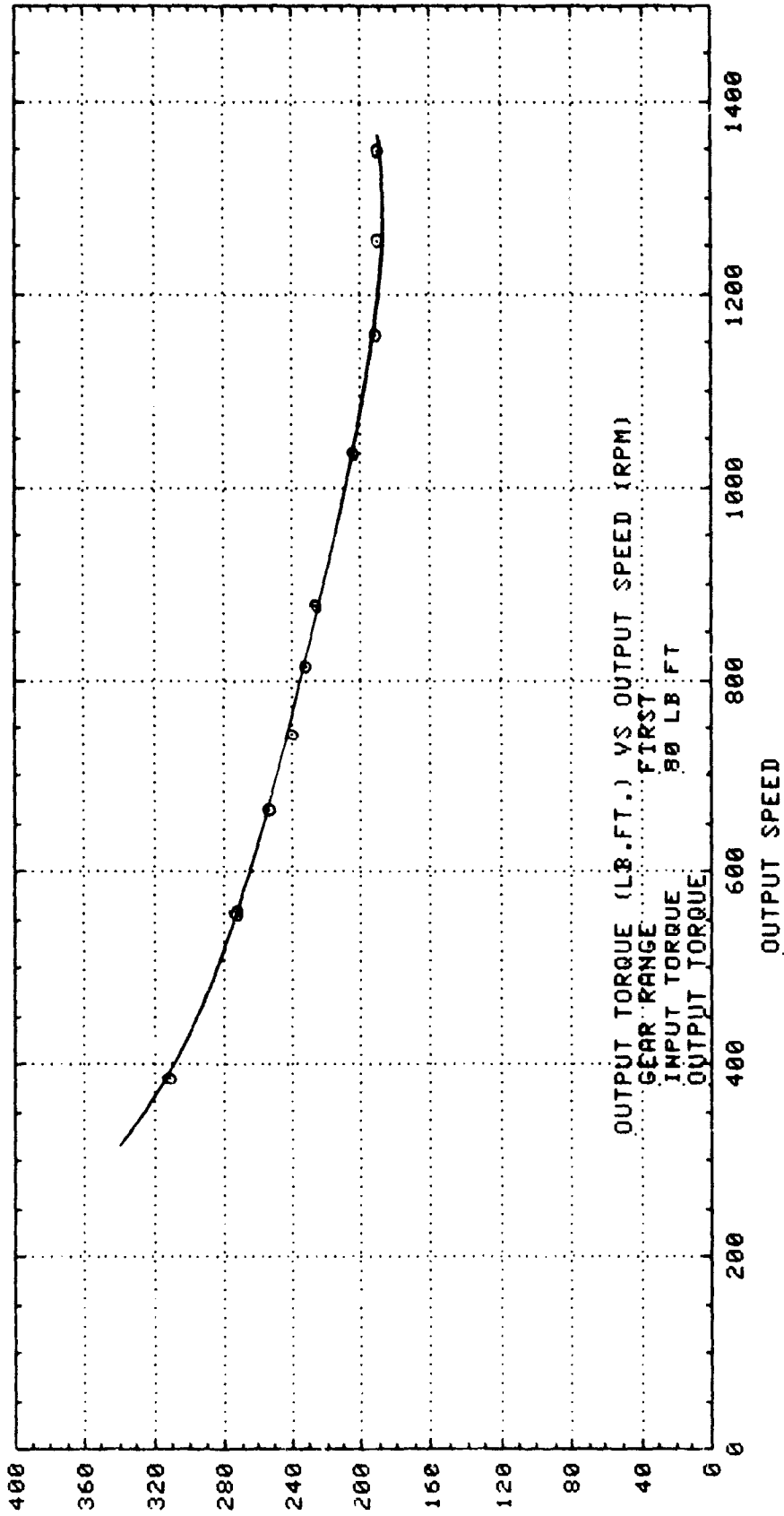

OUTPUT TORQUE

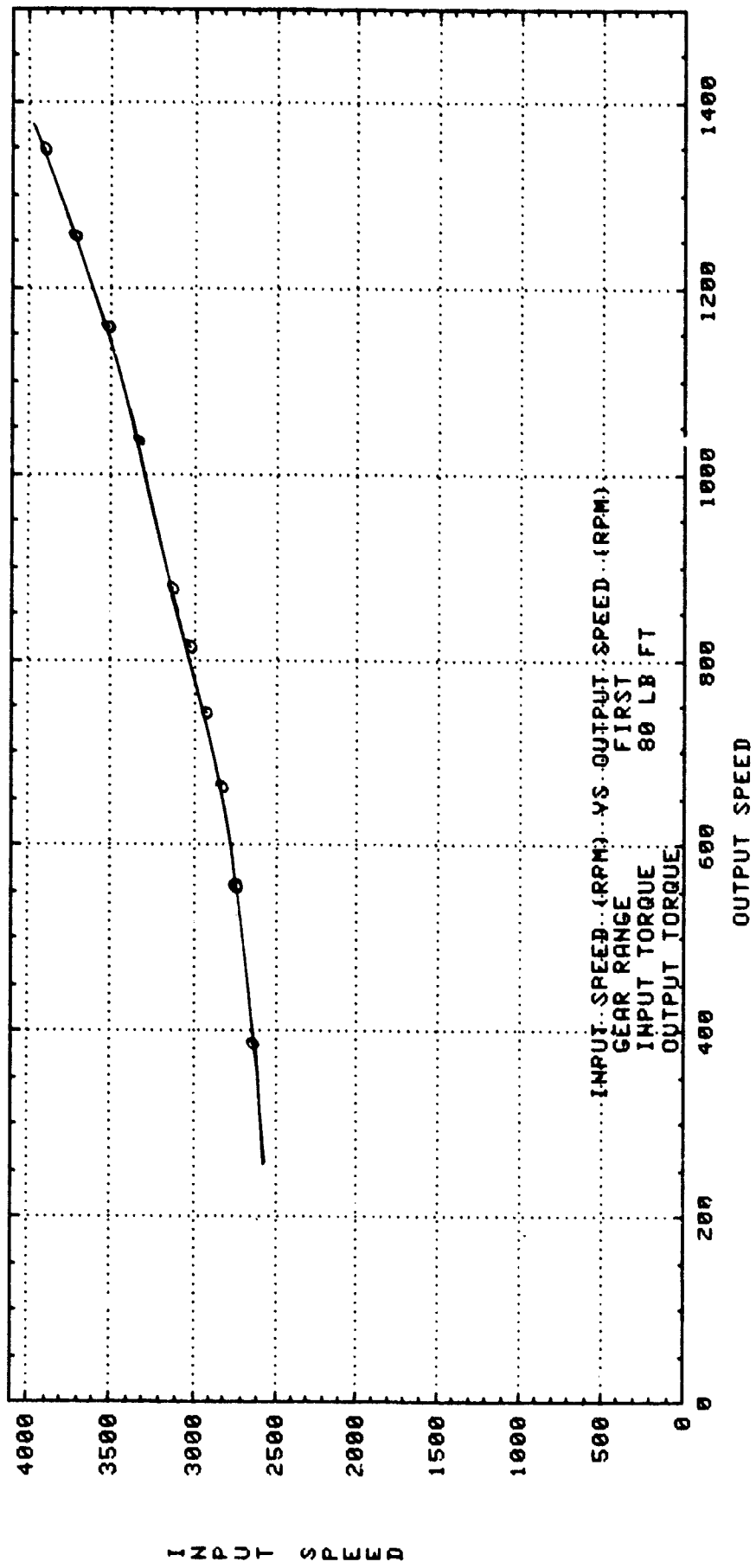

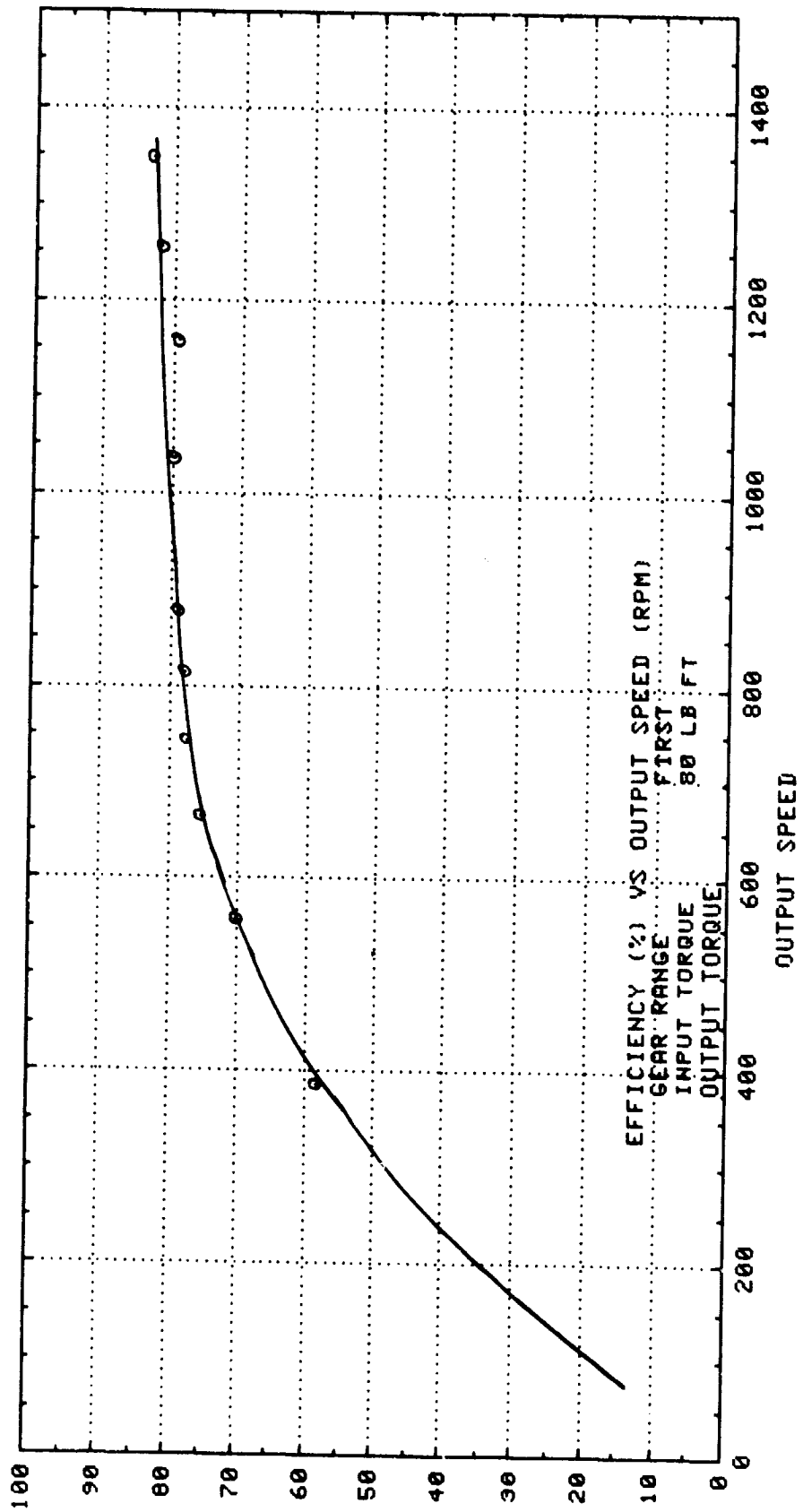

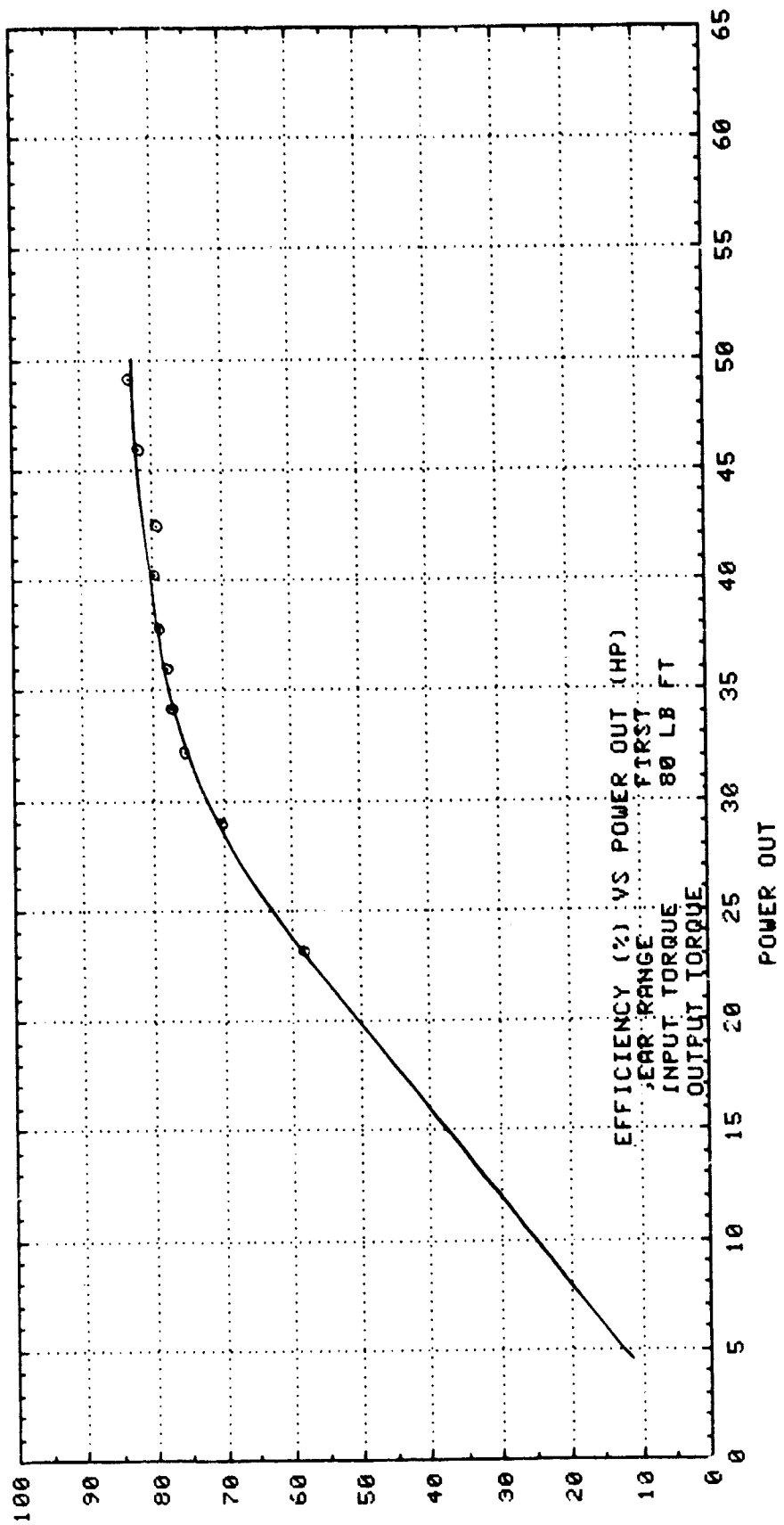

EFFICIENCY

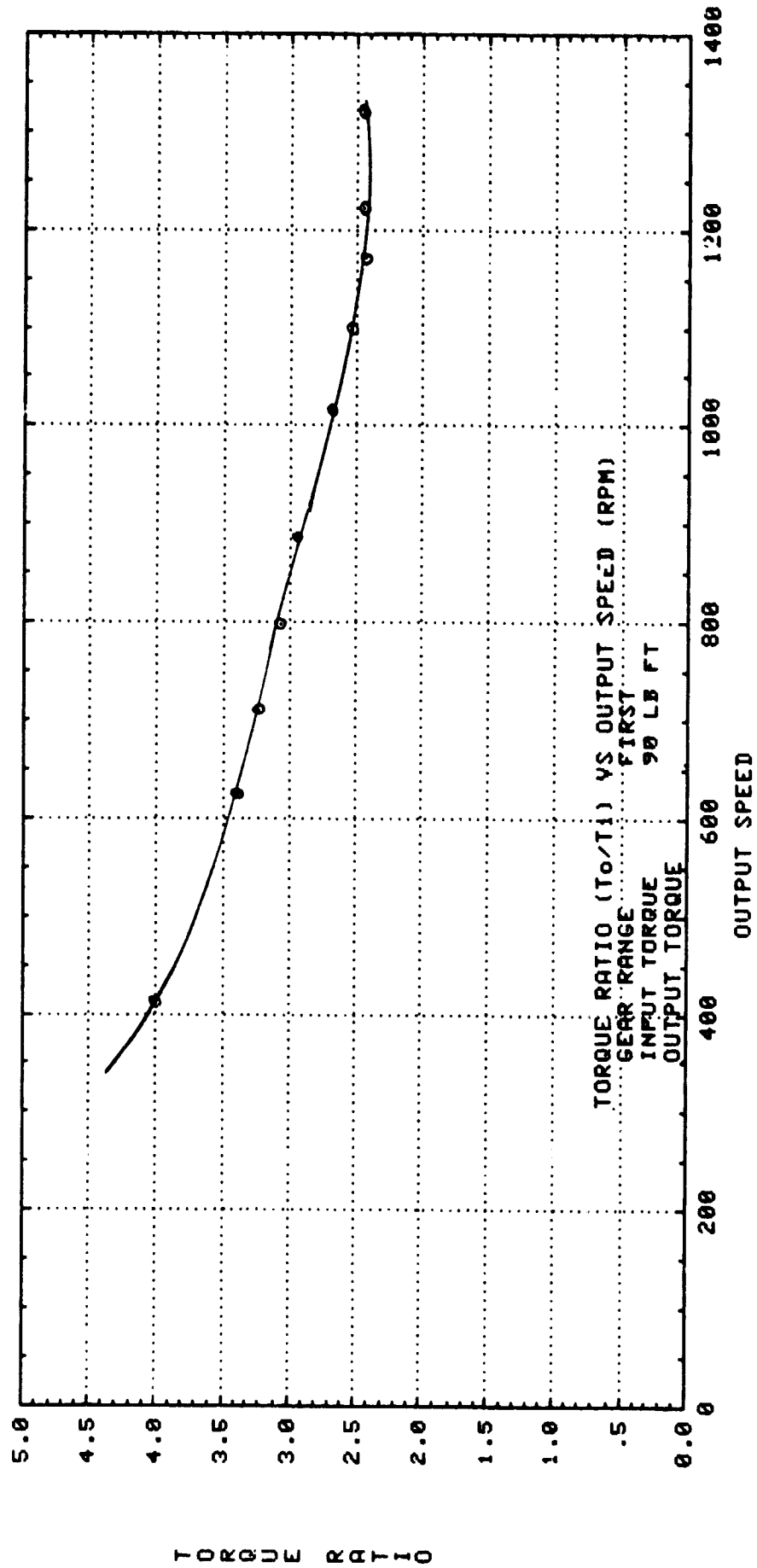

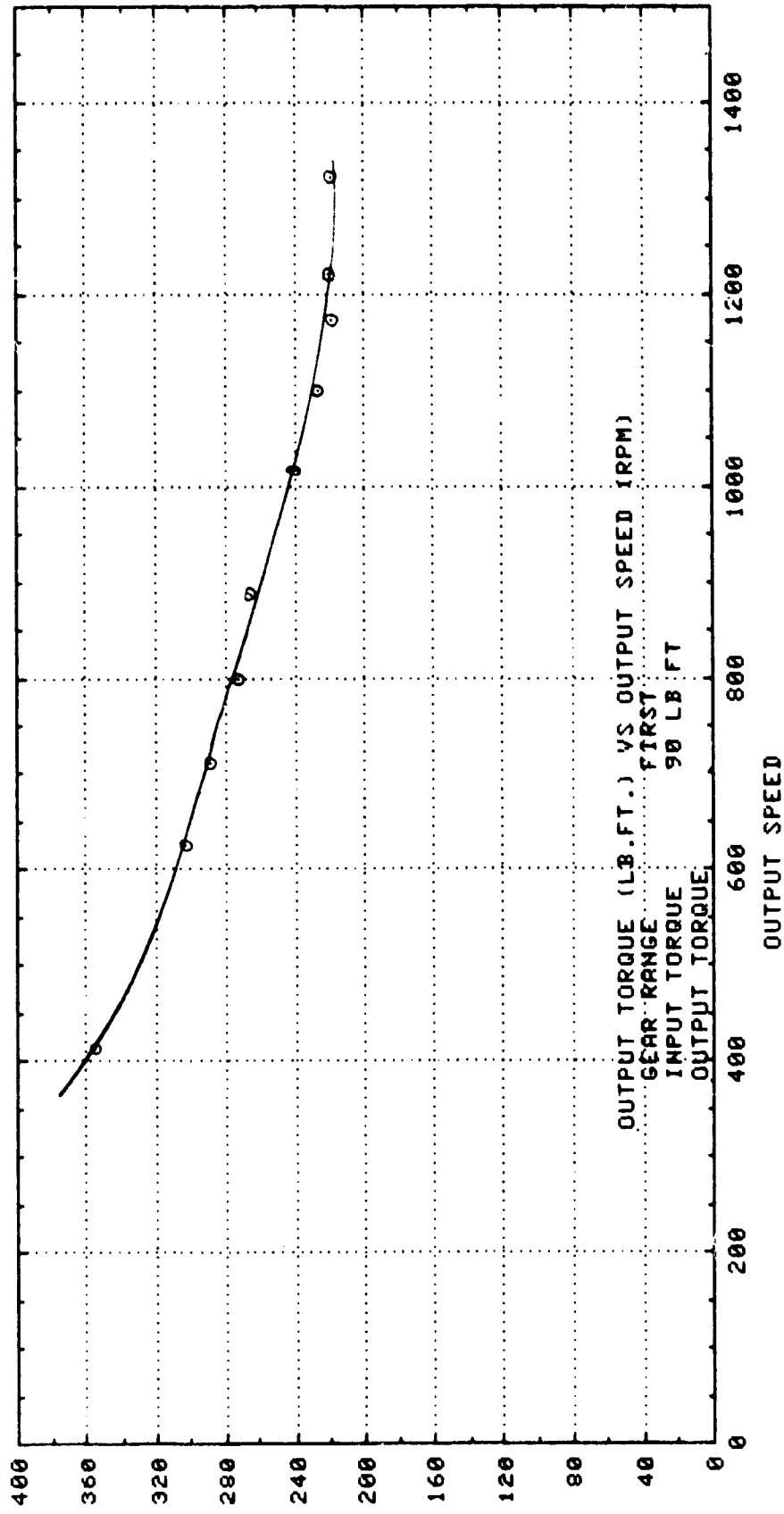

OUTPUT TORQUE

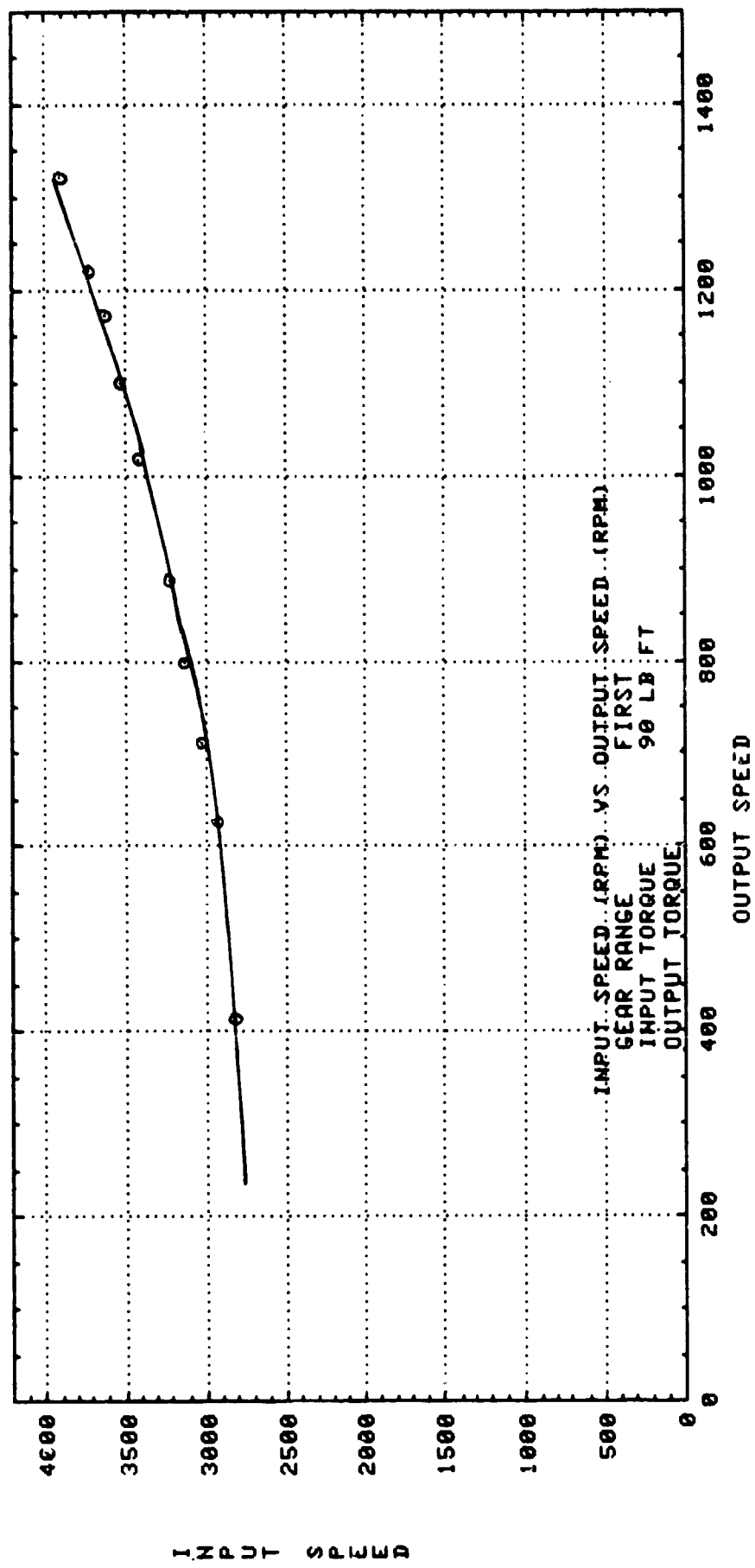



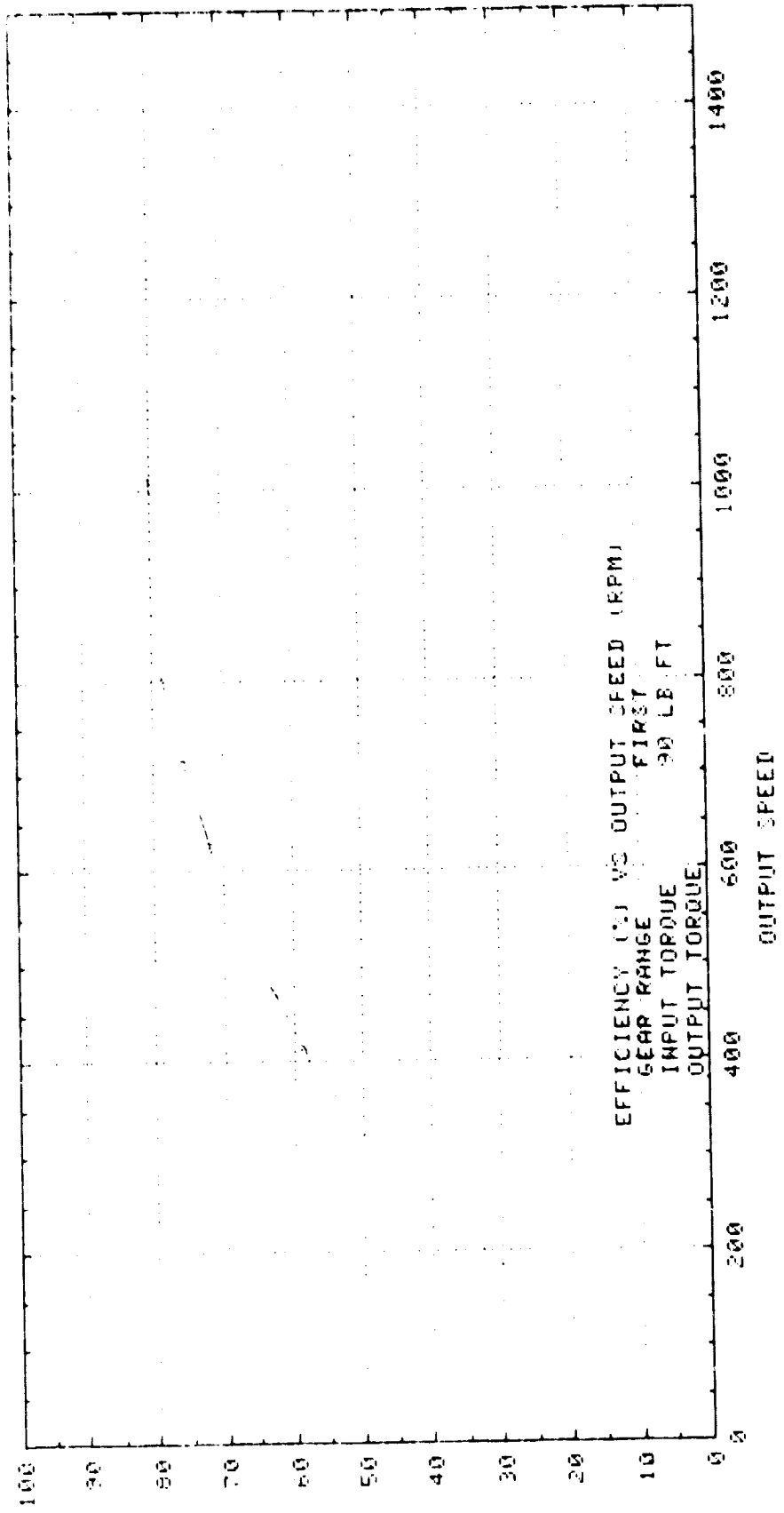

EFFICIENCY

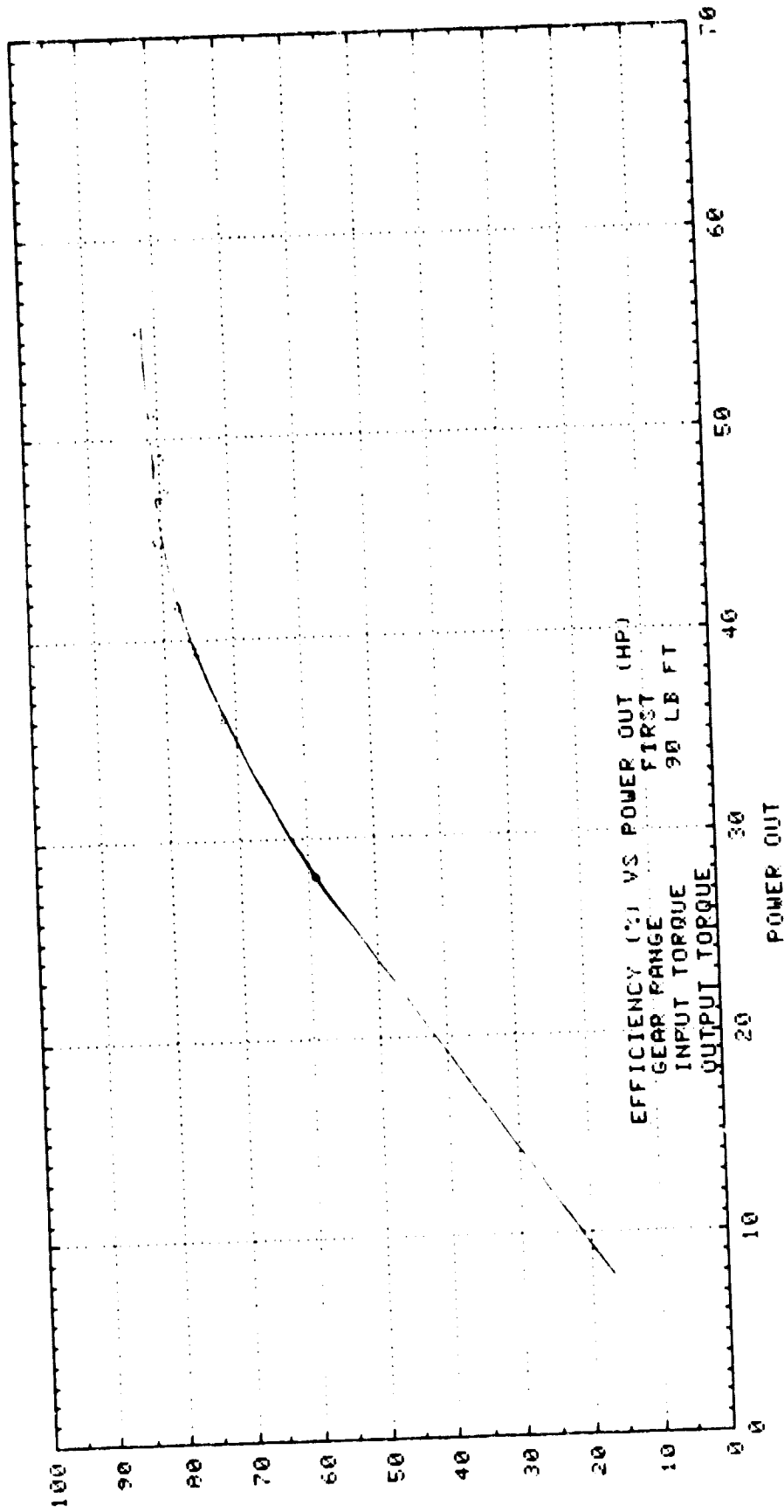

EFFICIENCY

**DRIVE PERFORMANCE**

**2nd Gear**

## Graphs Contained in This Section

78

Torque Ratio -vs- Output Speed

Output Torque -vs- Output Speed

Input Speed -vs- Output Speed

Efficiency -vs- Output Speed

Efficiency -vs- Power Out

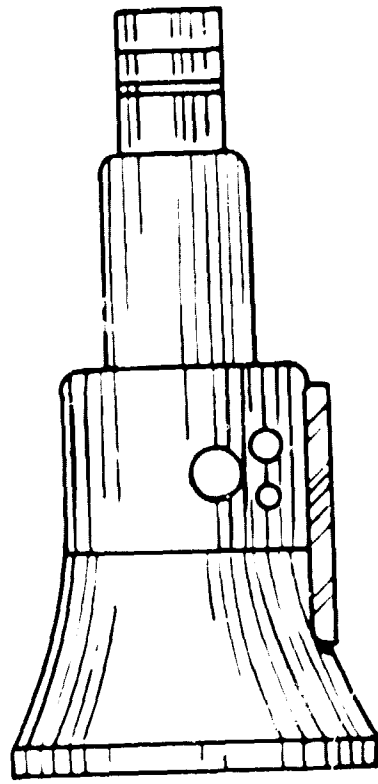

Torque In

Speed In

Torque Out

Speed Out

---

Drive Performance Tests

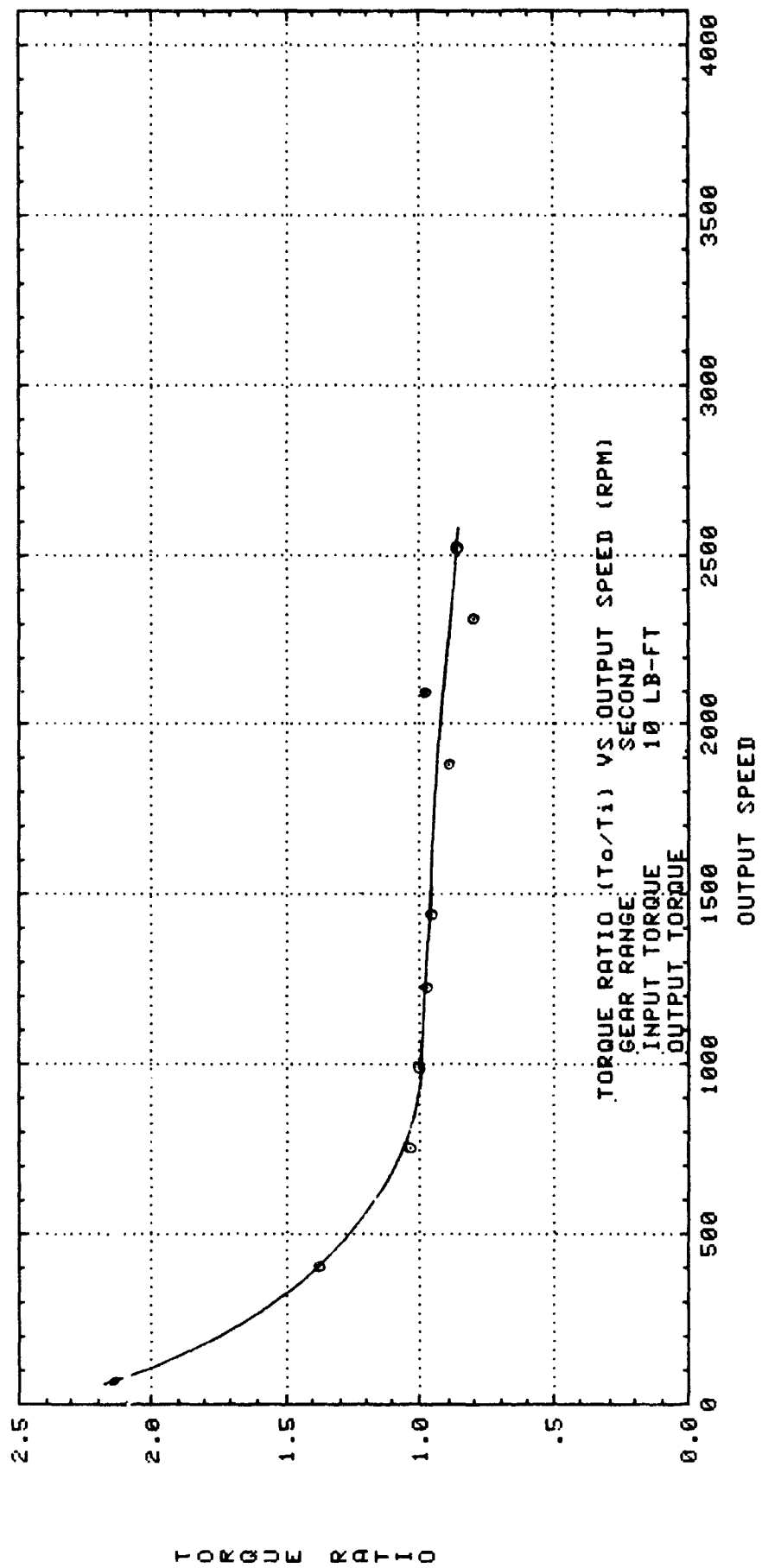

TORQUE RATIO

OUTPUT TORQUE

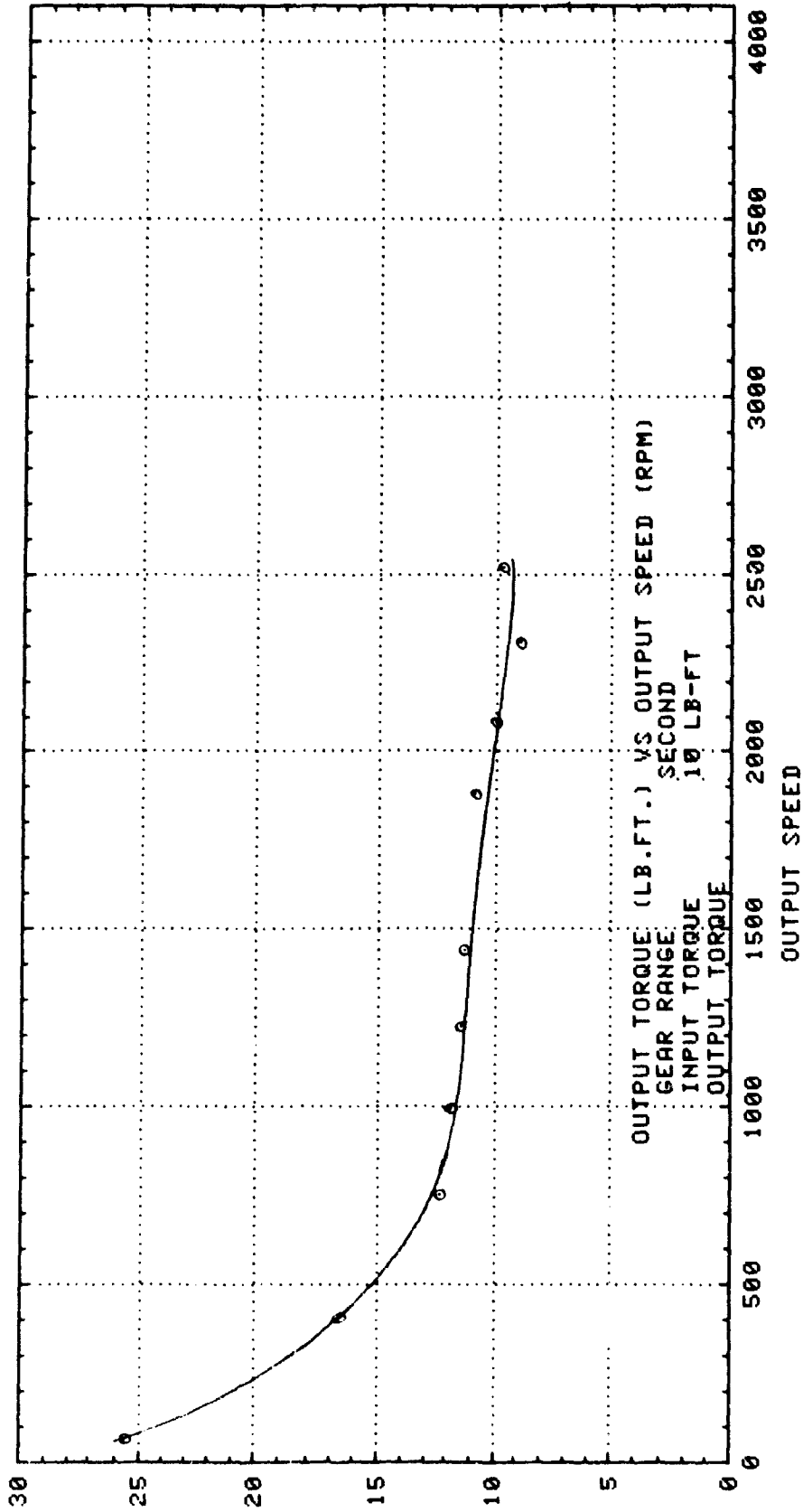

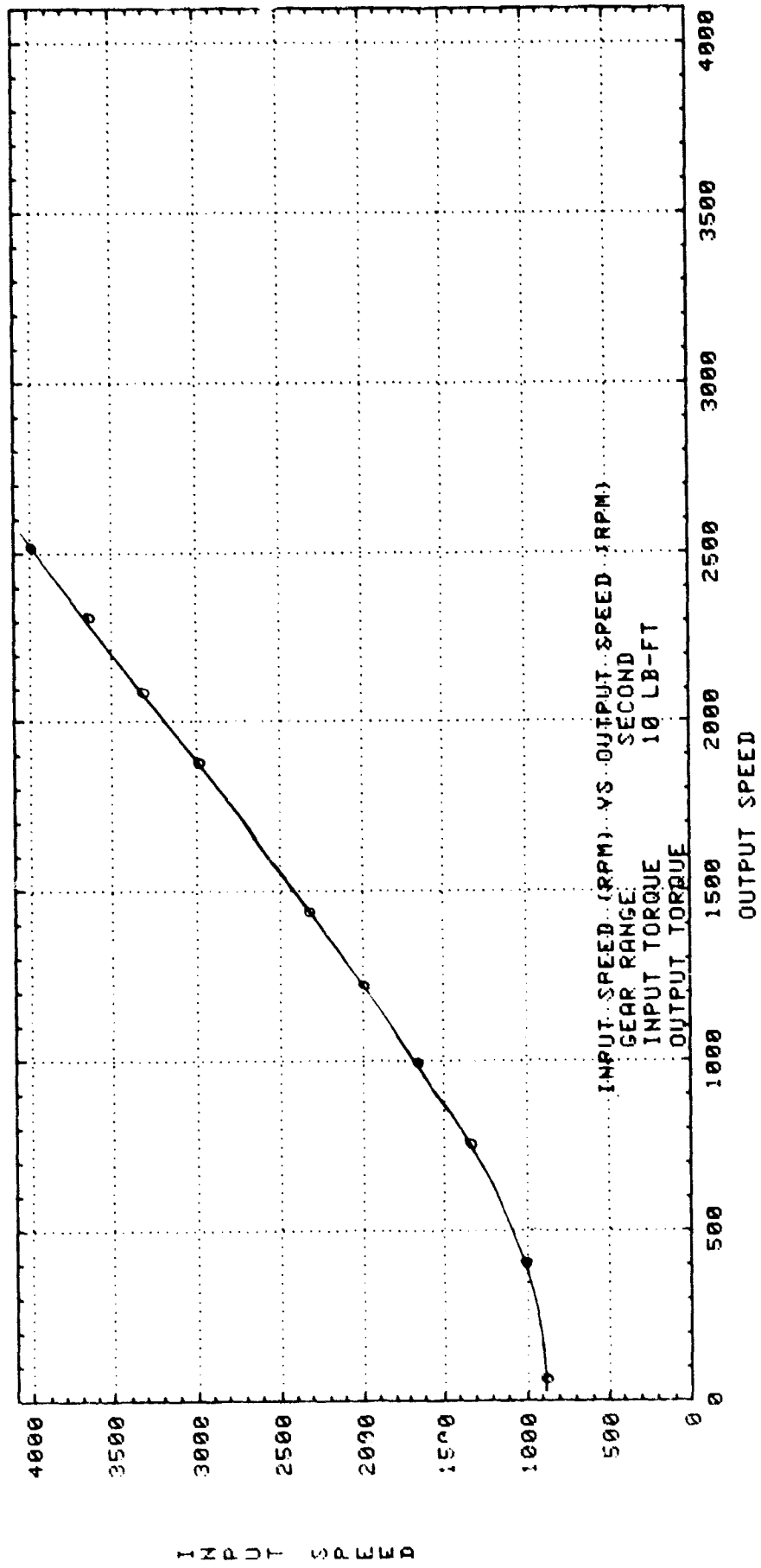

INPUT SPEED

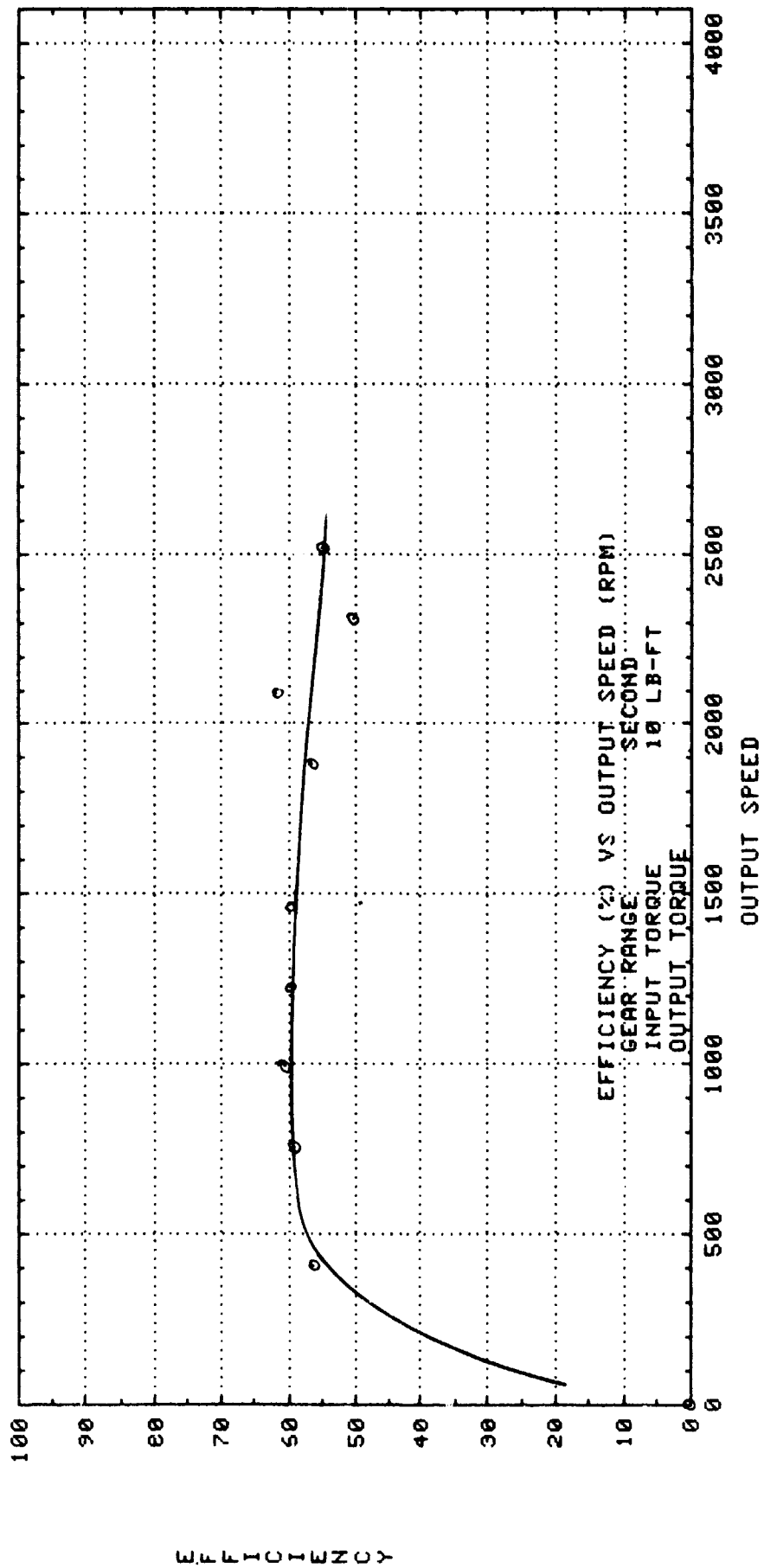

EFFICIENCY



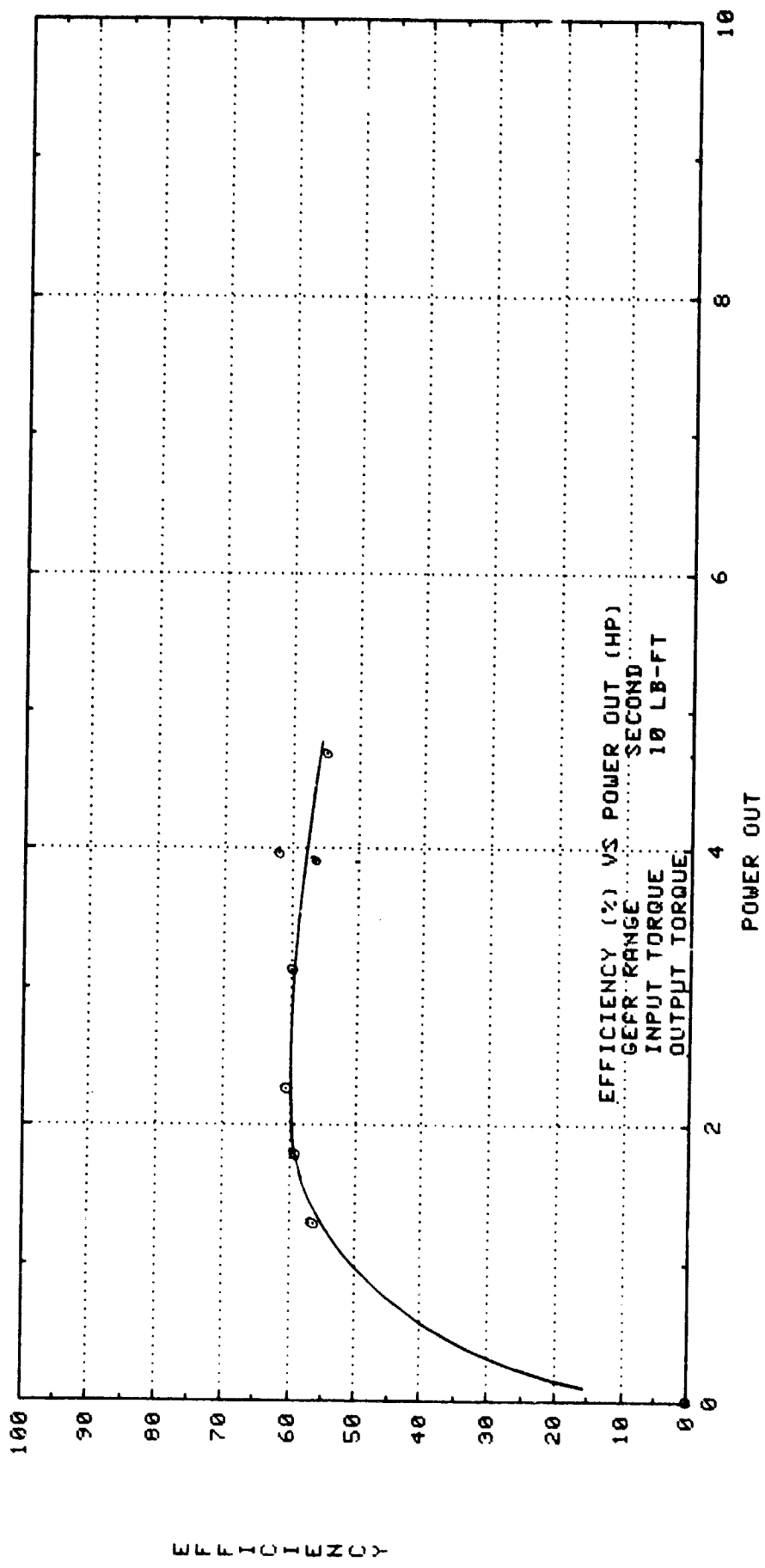

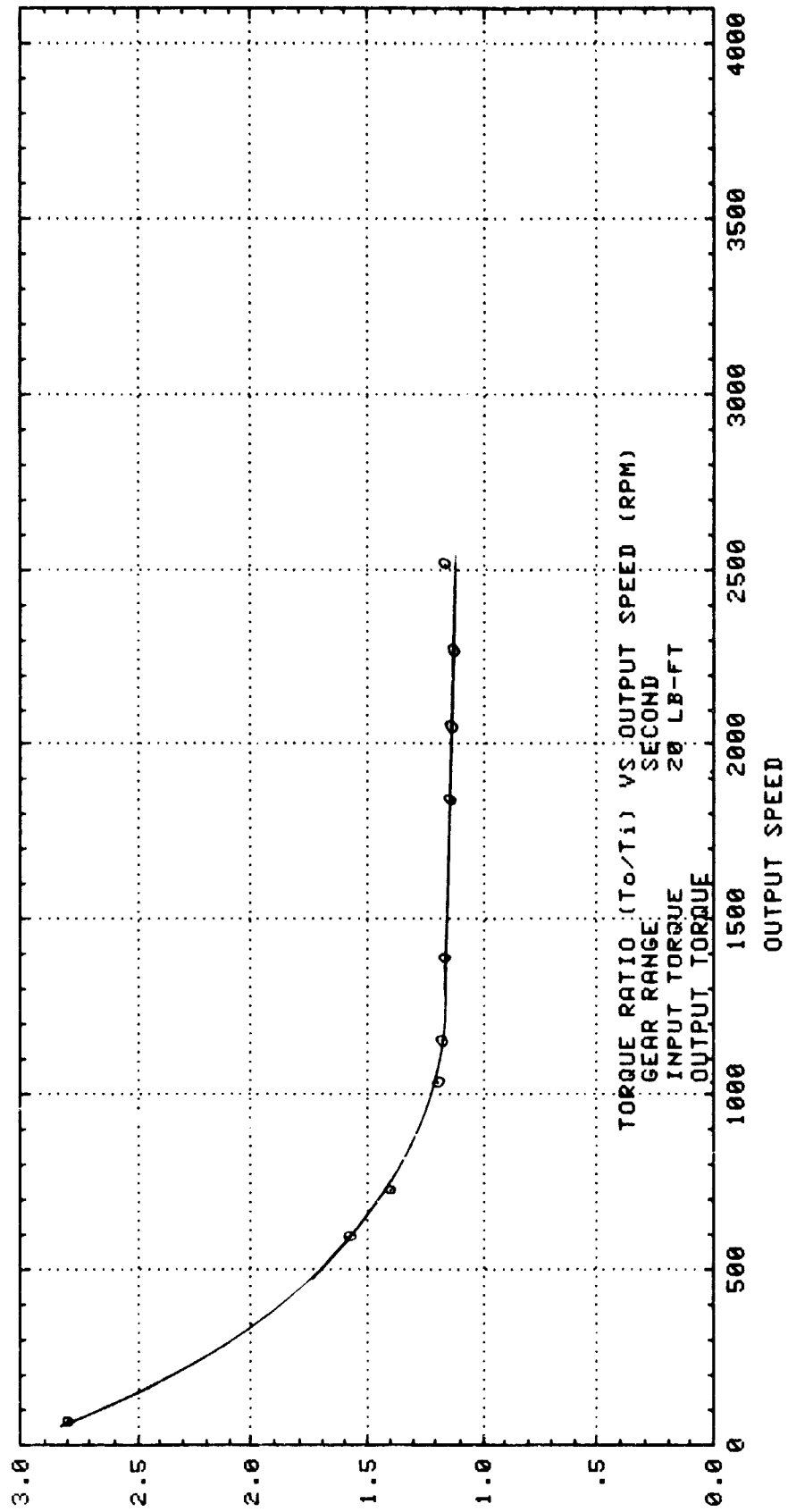

TORQUE RATIO

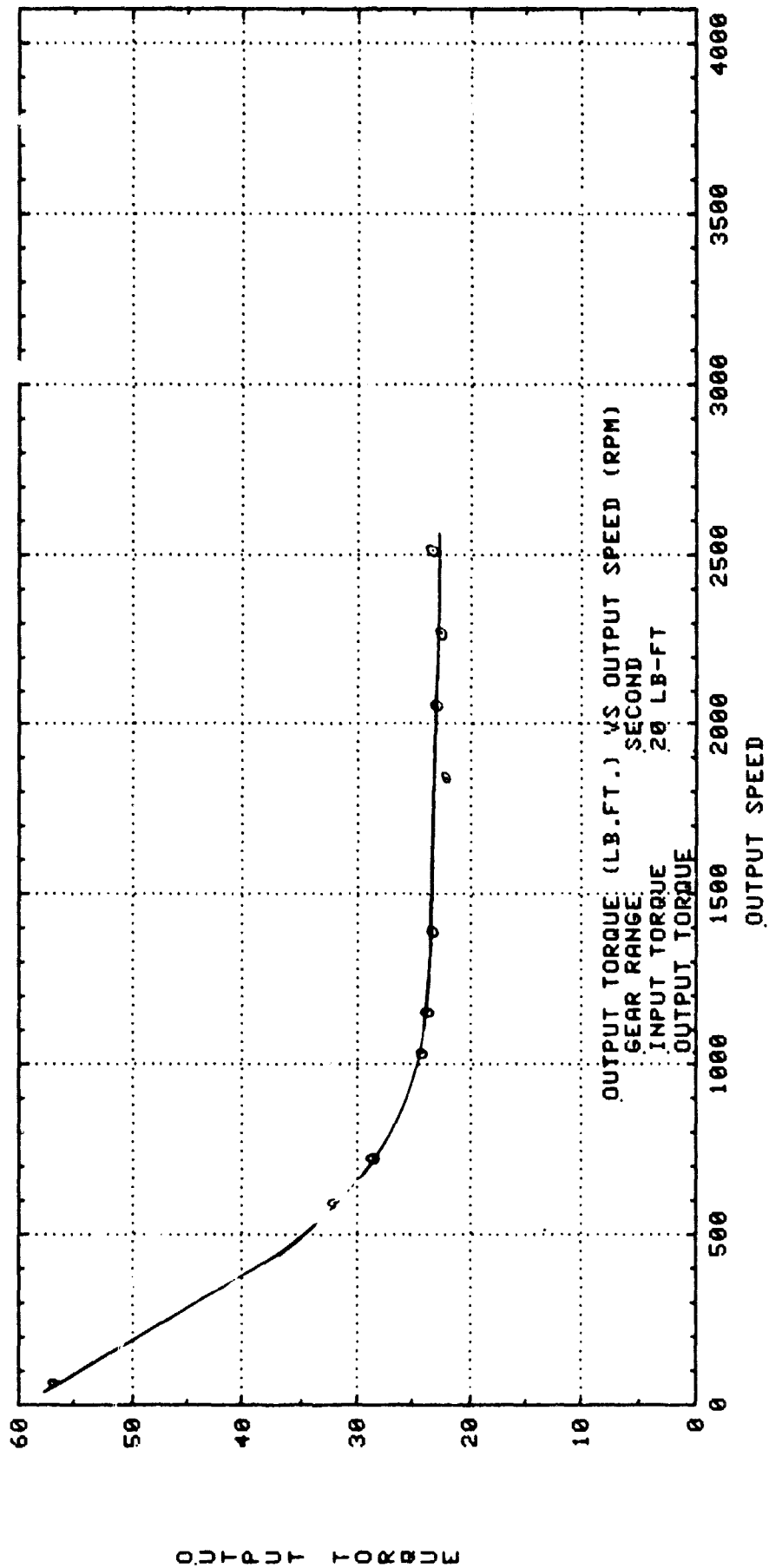

OUTPUT TORQUE

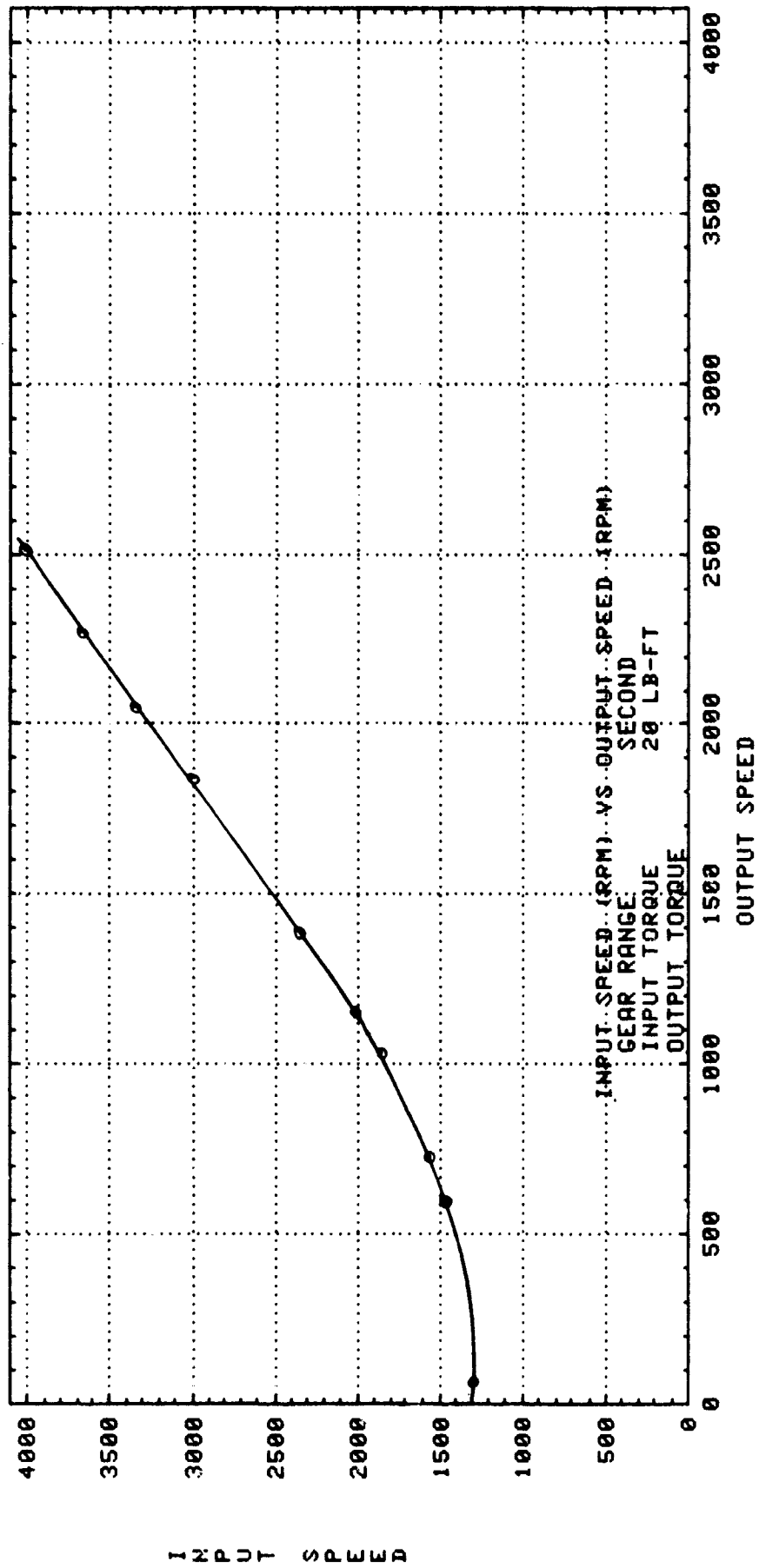

INPUT SPEED

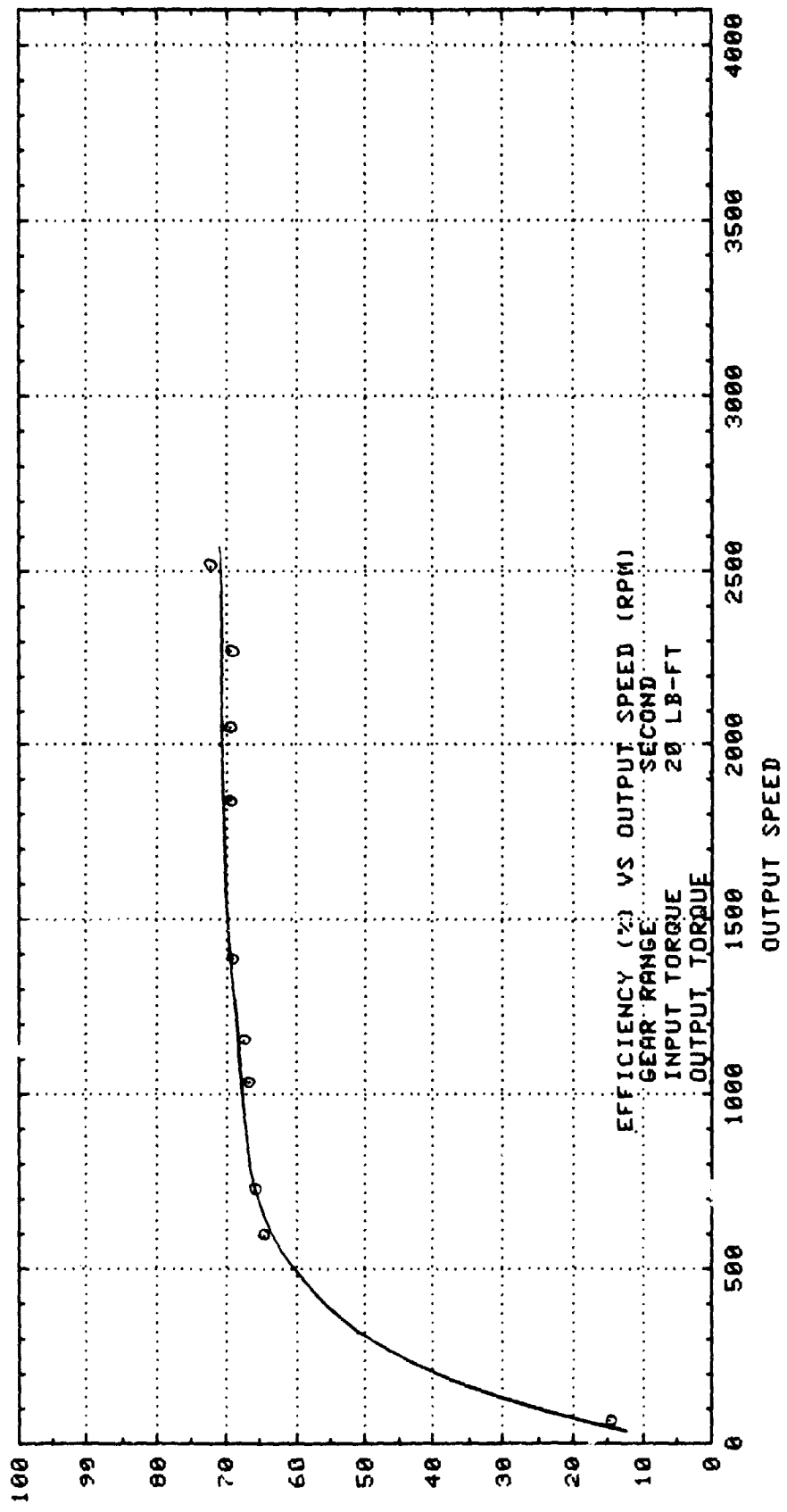

EFFICIENCY

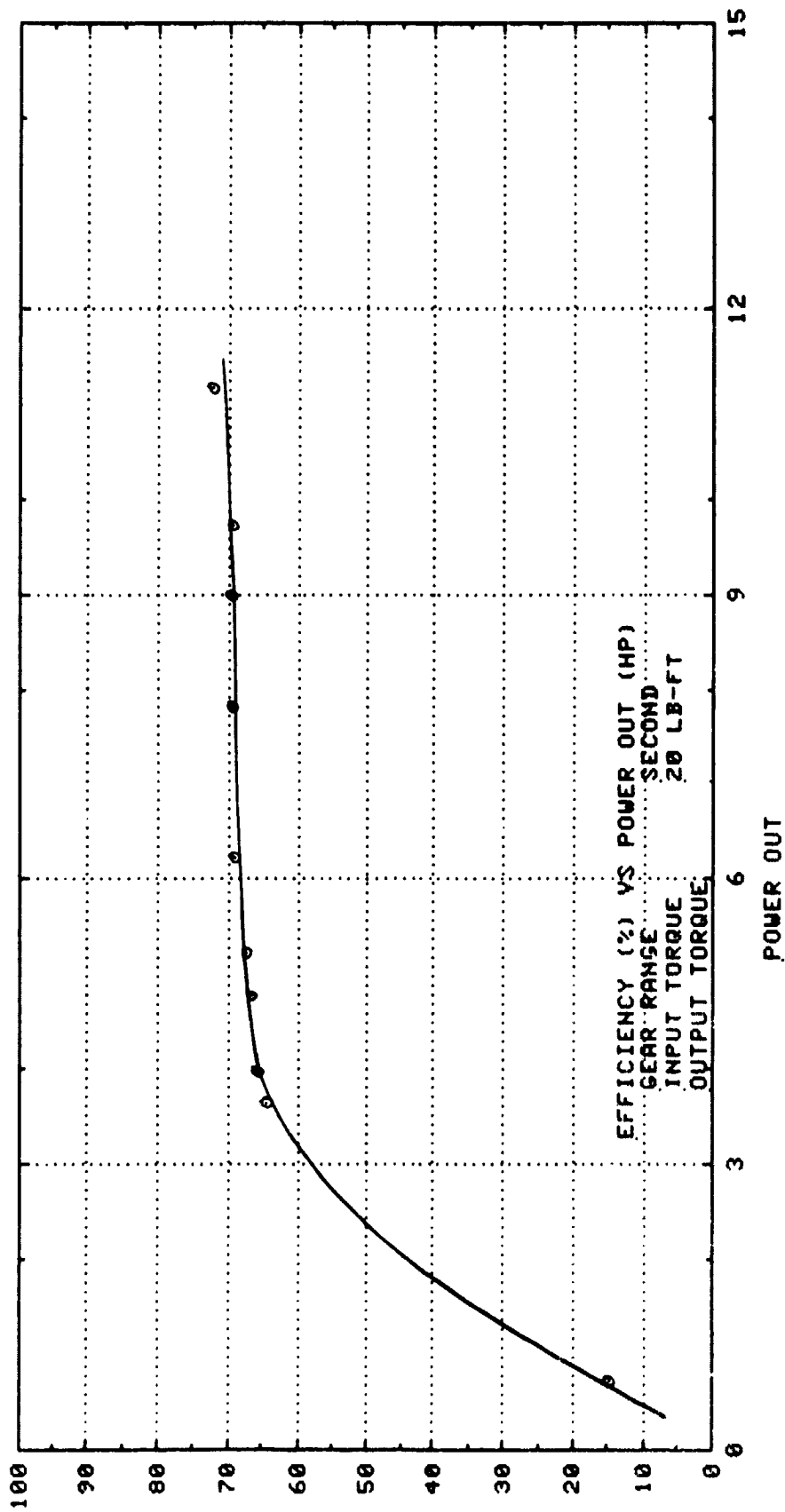

EFFICIENCY

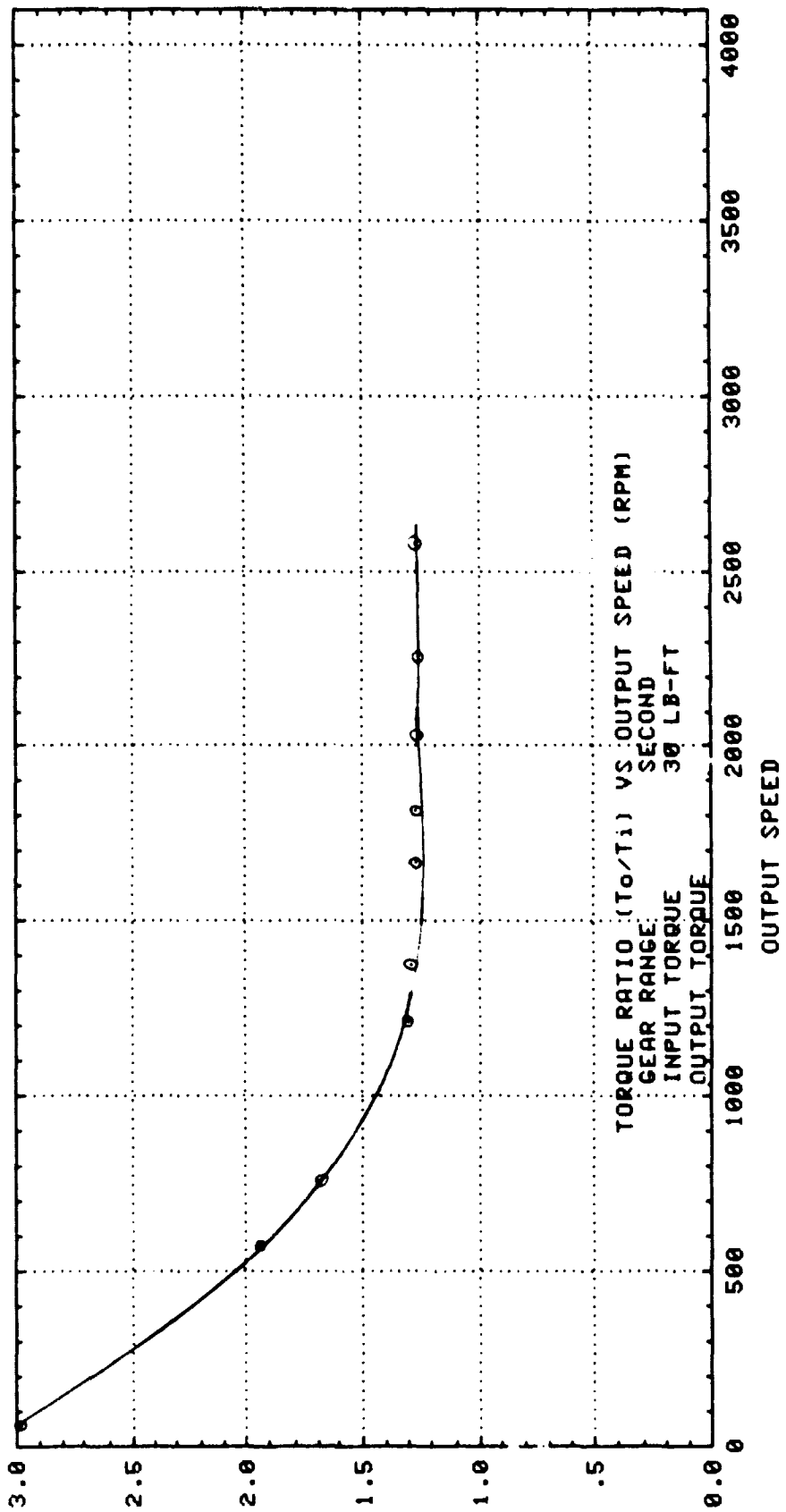

TORQUE RATIO

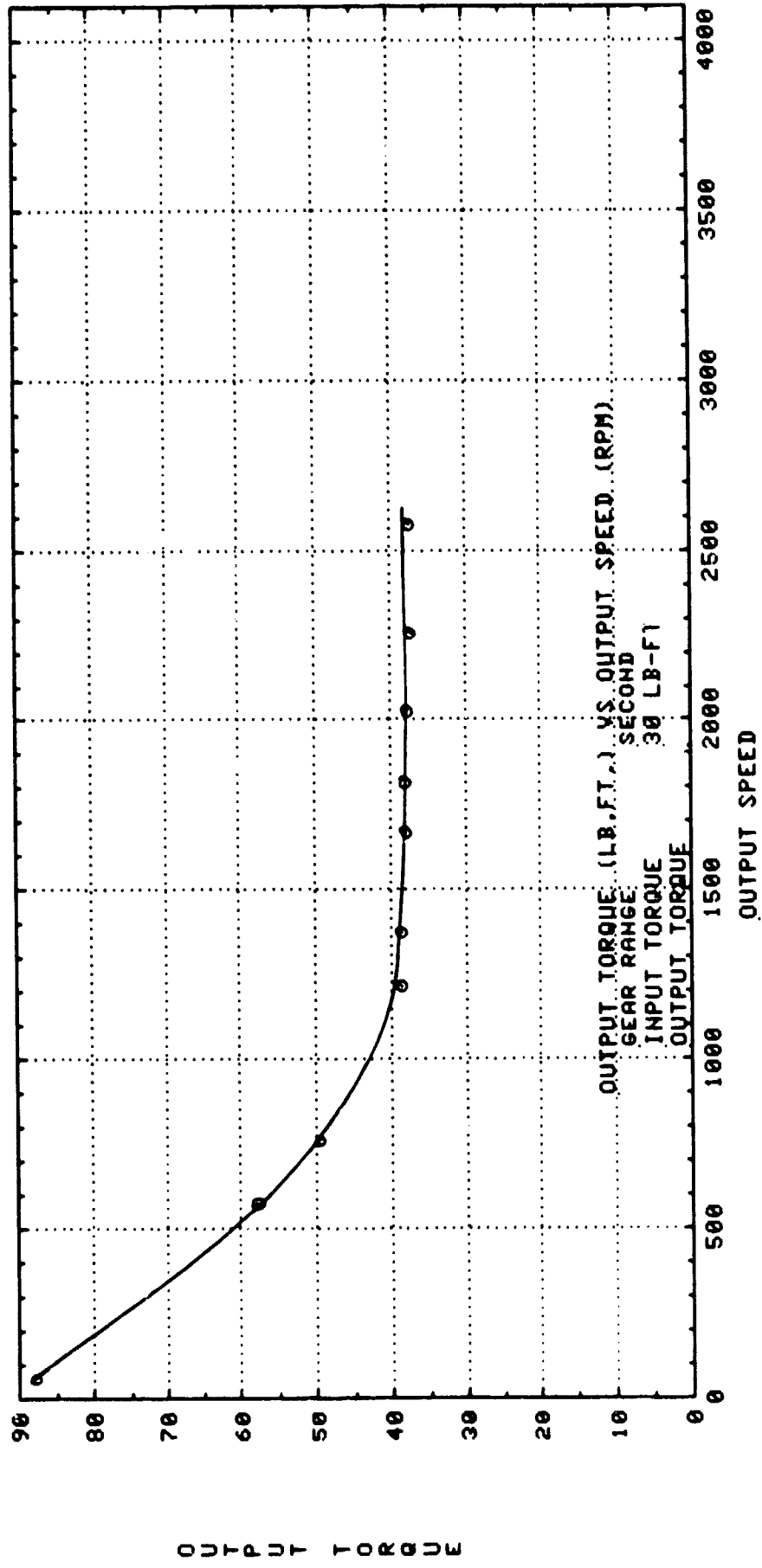



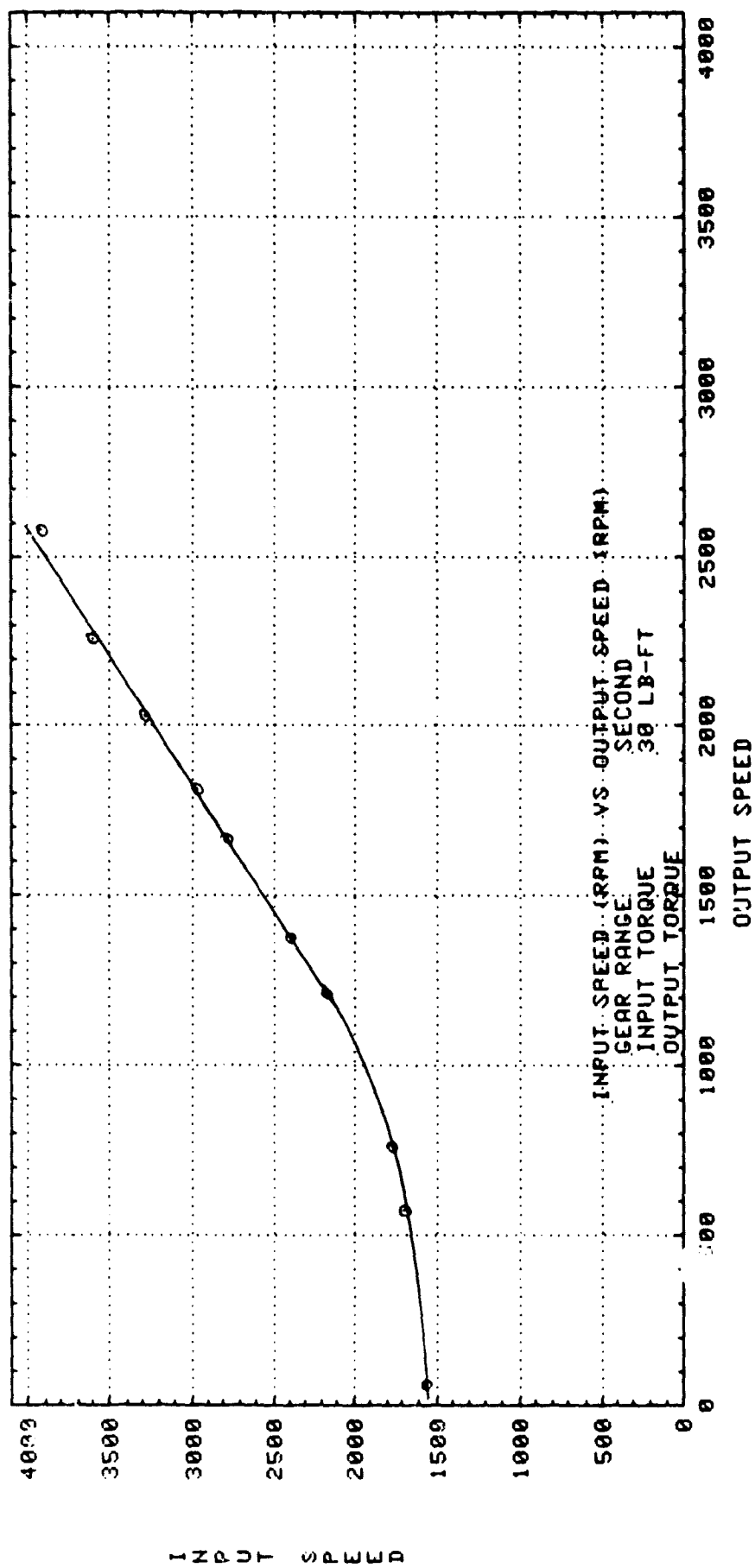

INPUT SPEED

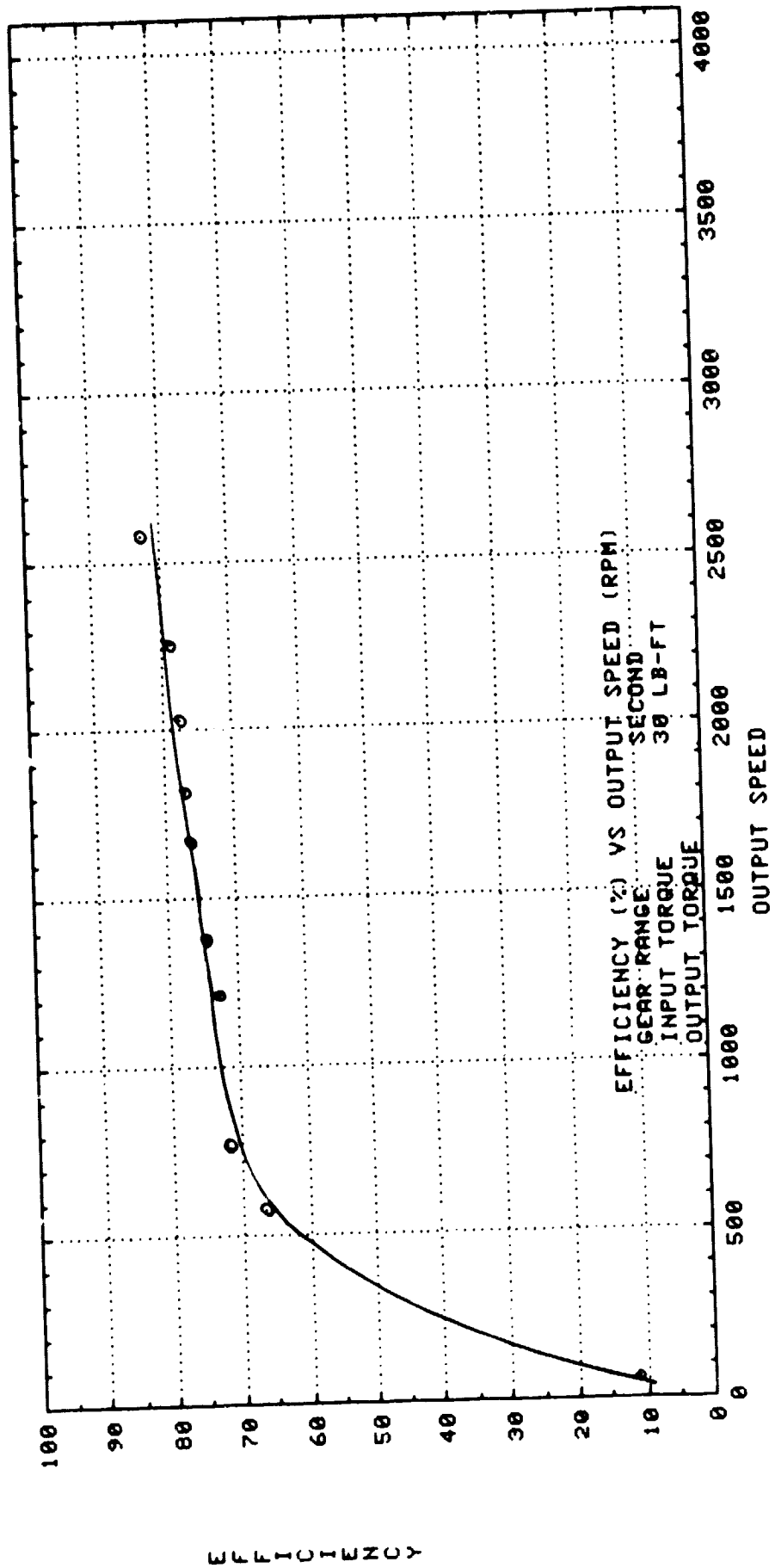

2

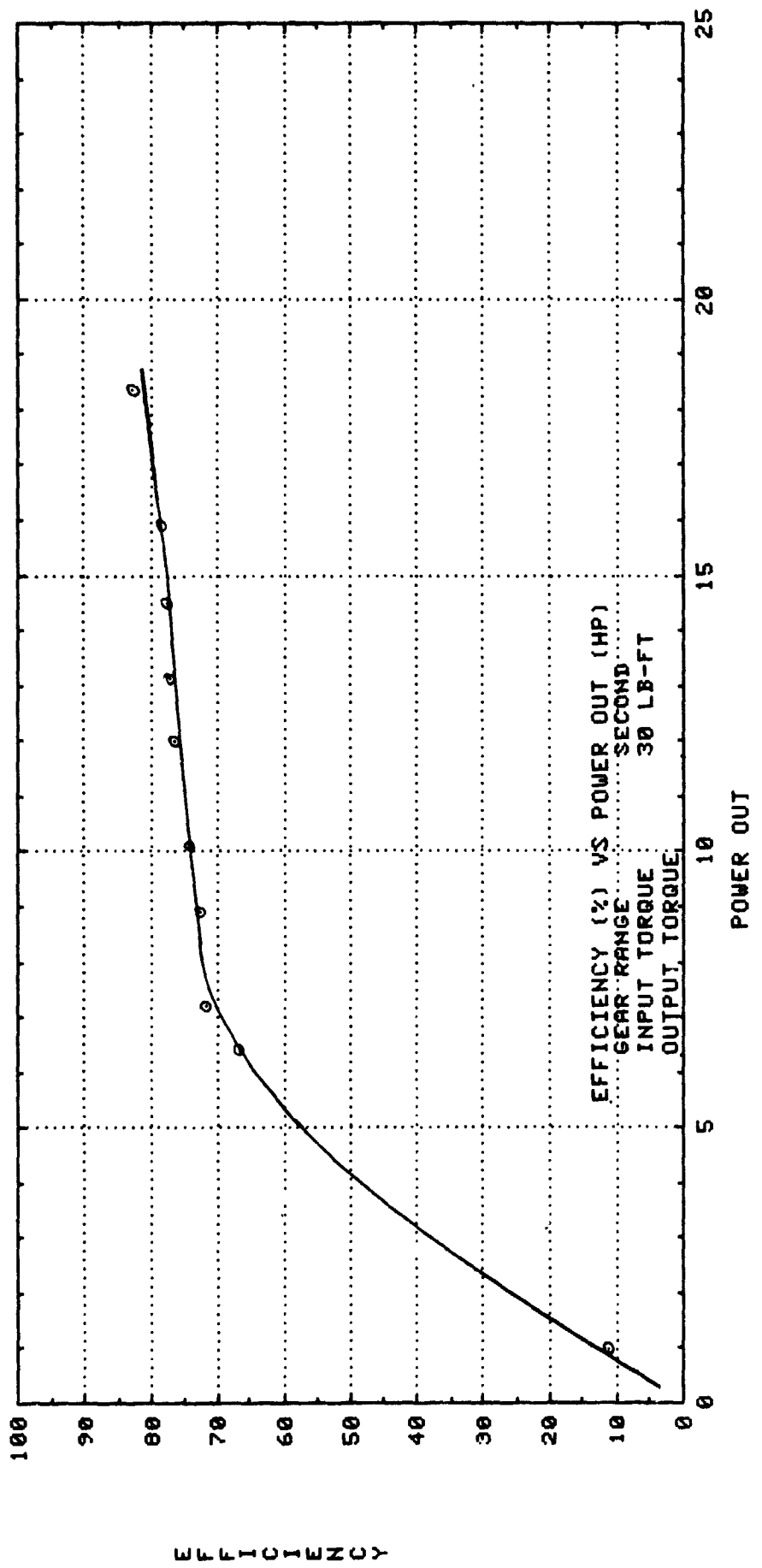

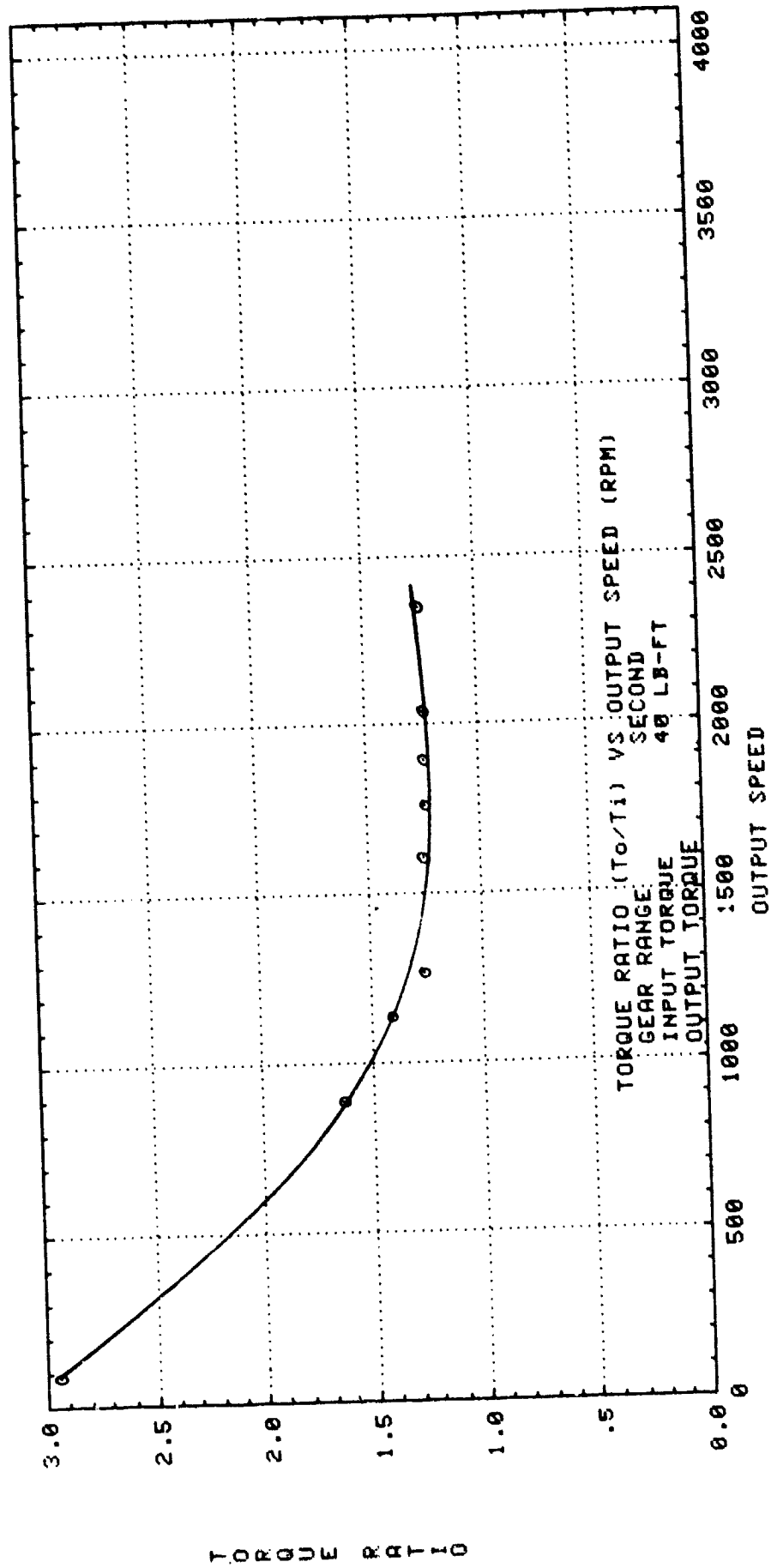

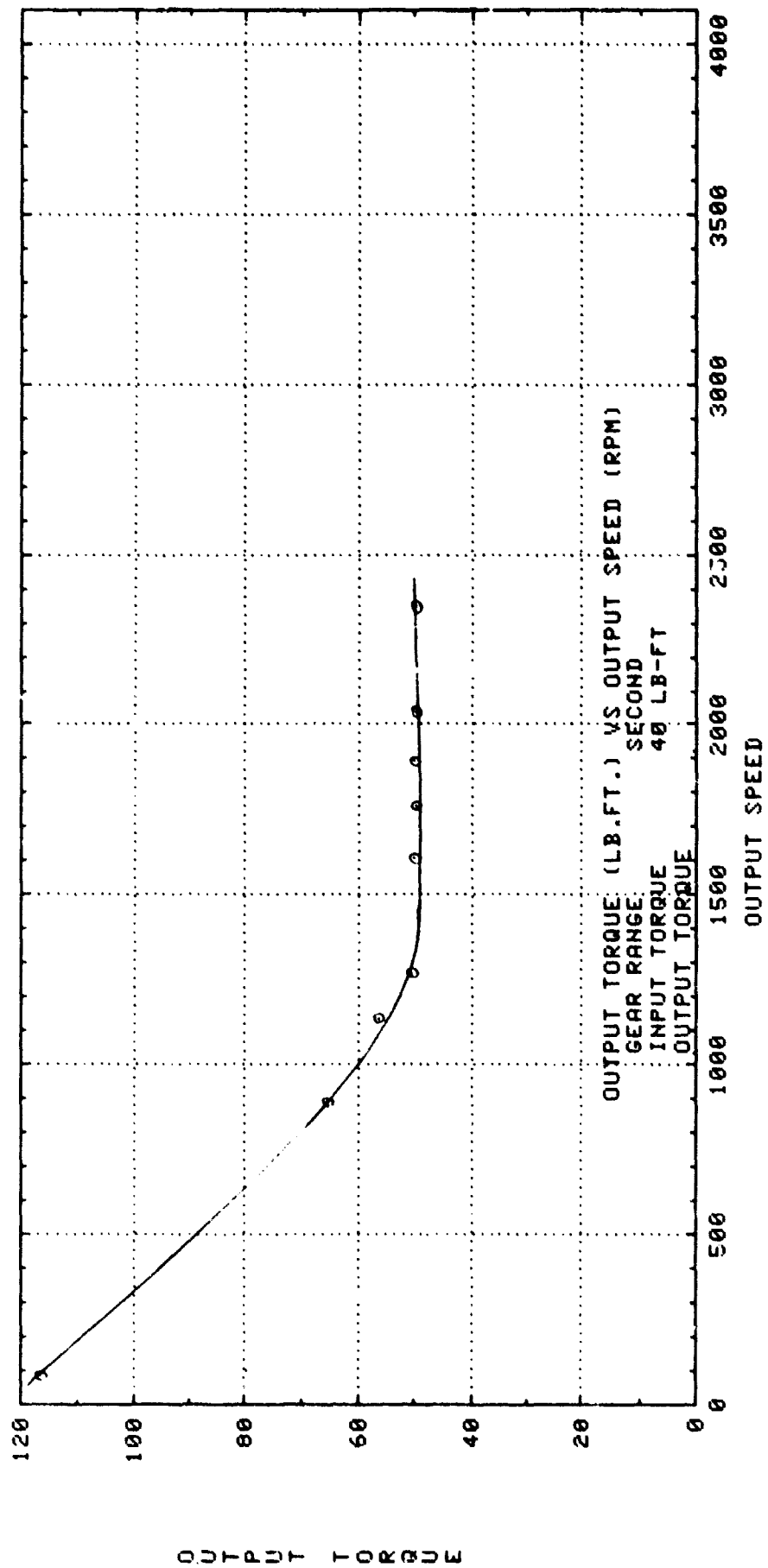

OUTPUT TORQUE

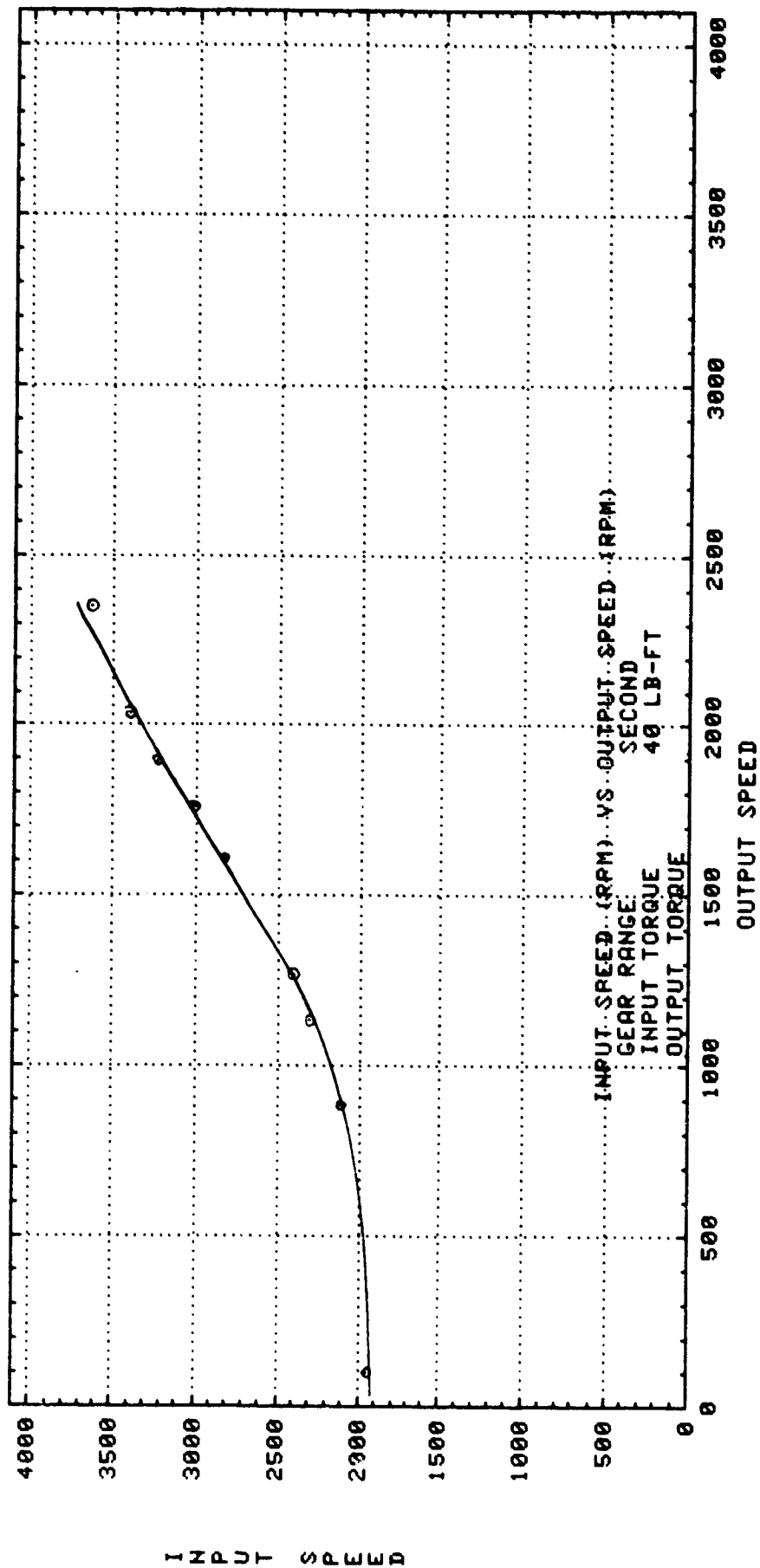

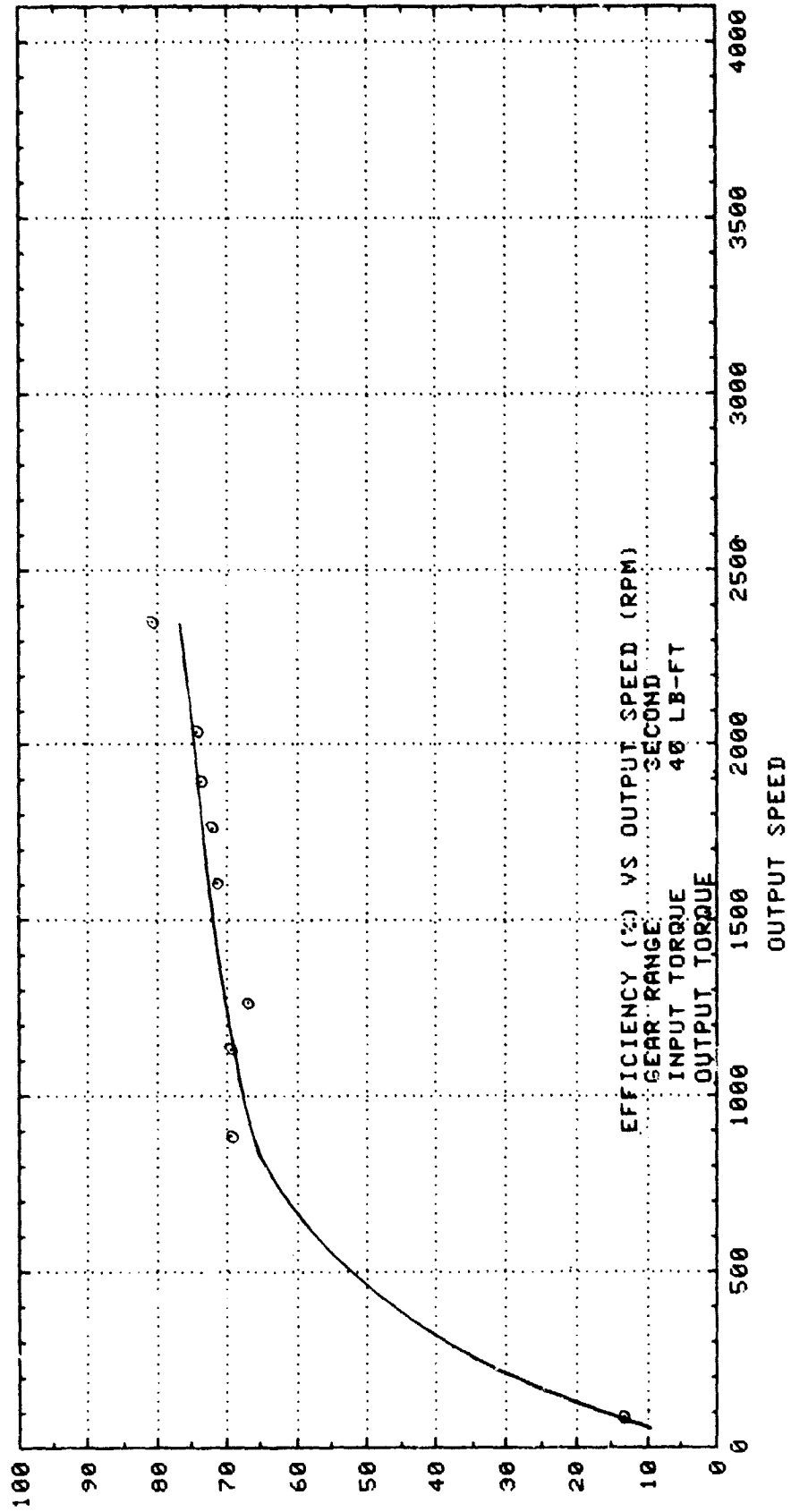

EFFICIENCY

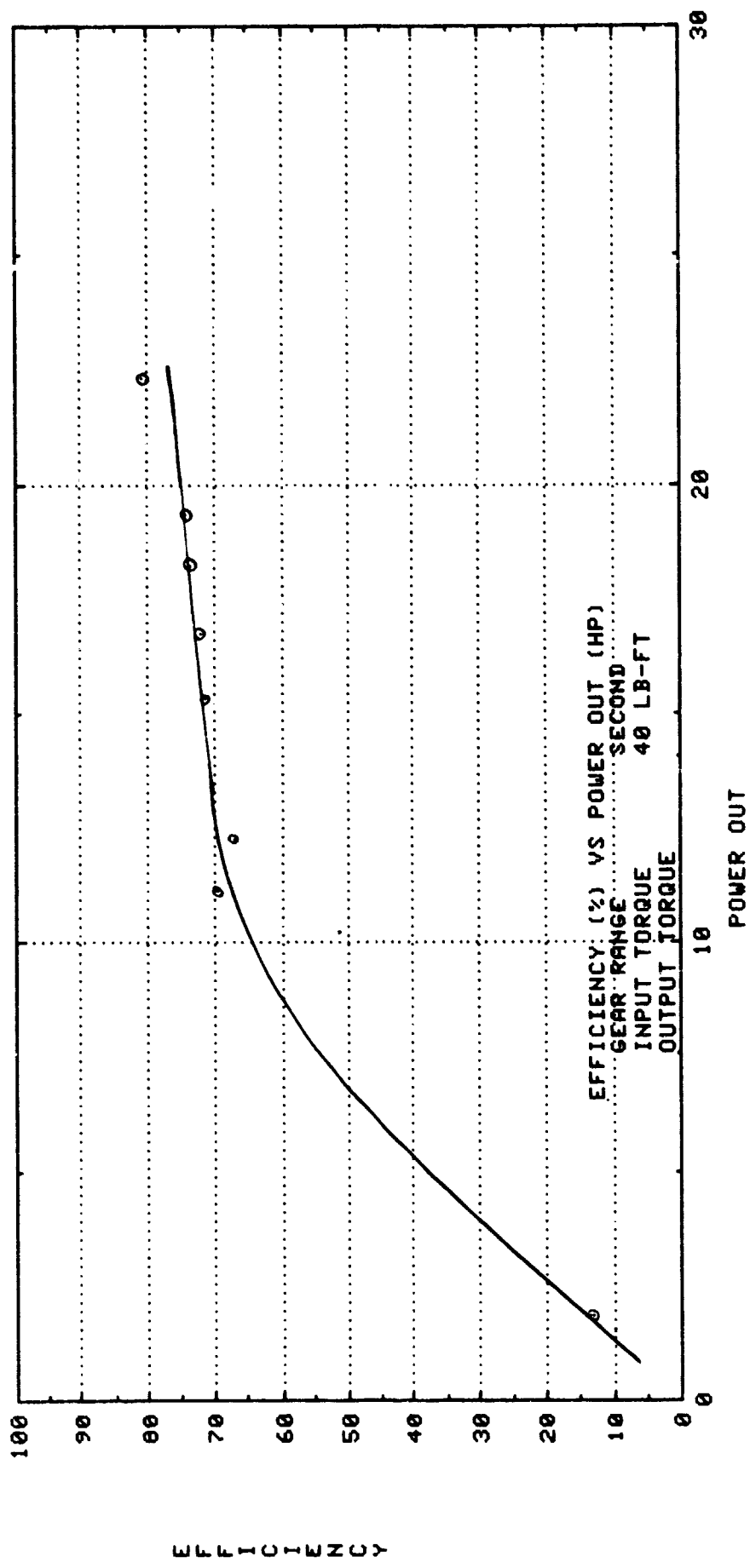



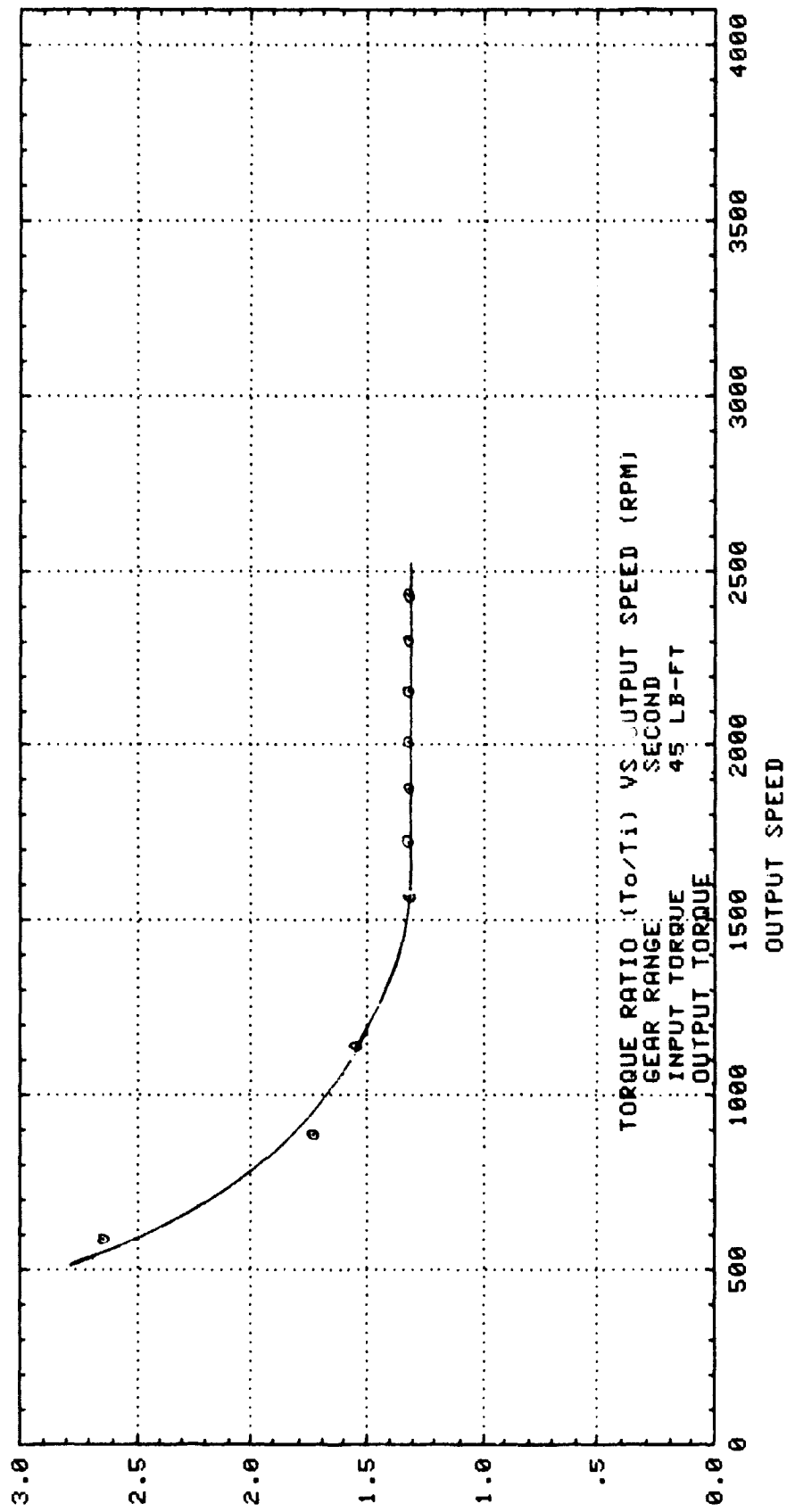

TORQUE RATIO

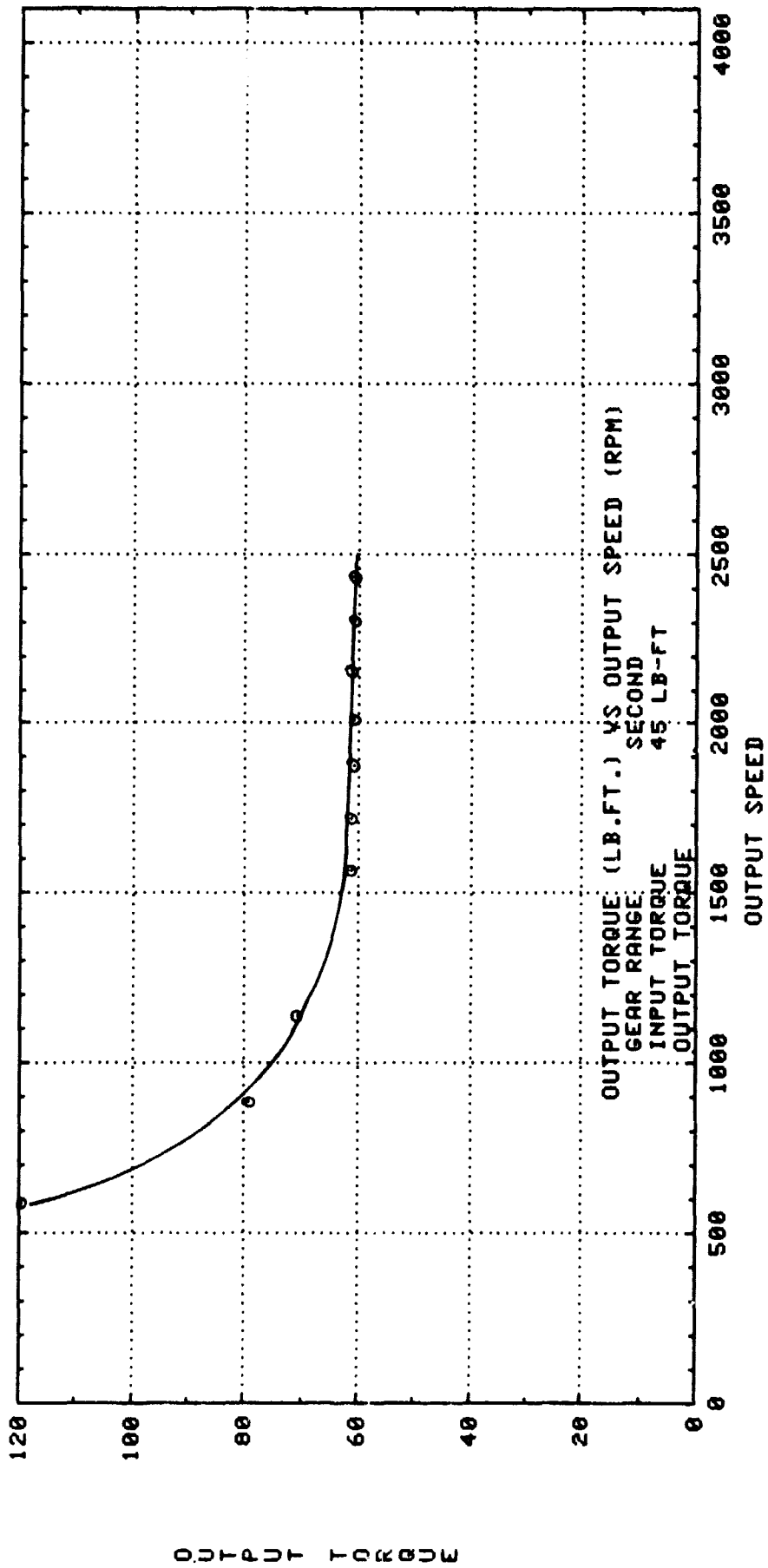

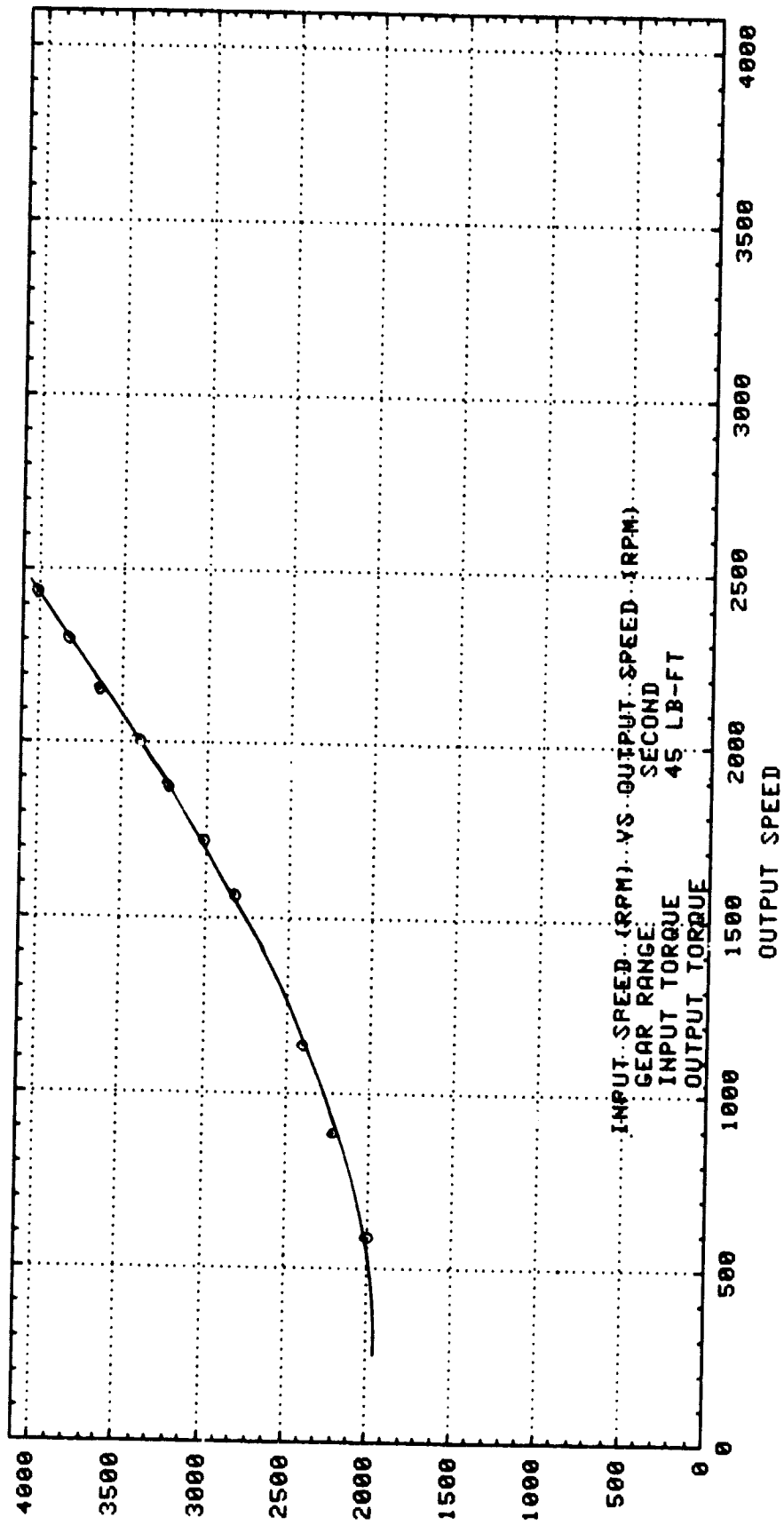

INPUT SPEED

EFFICIENCY

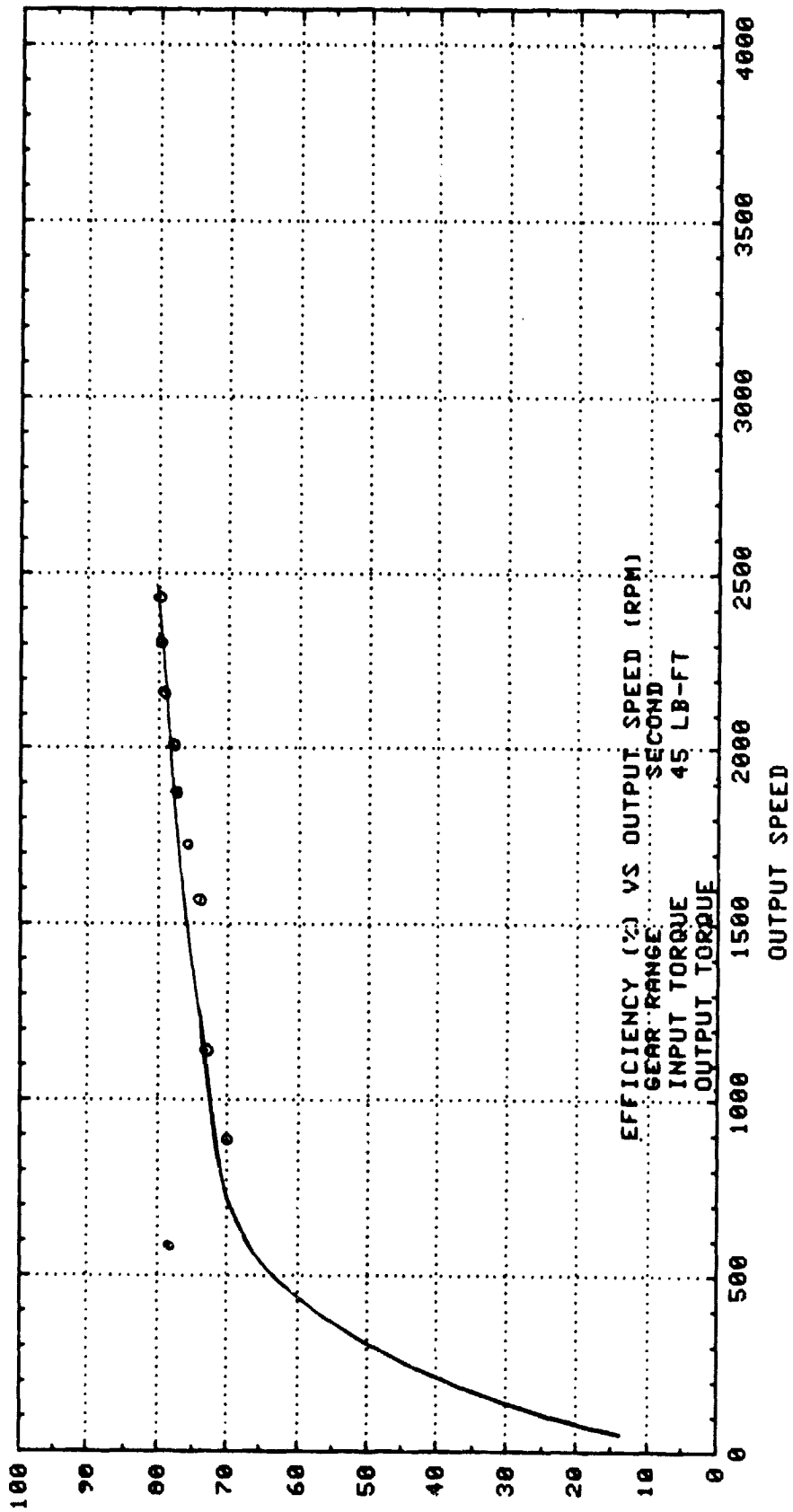

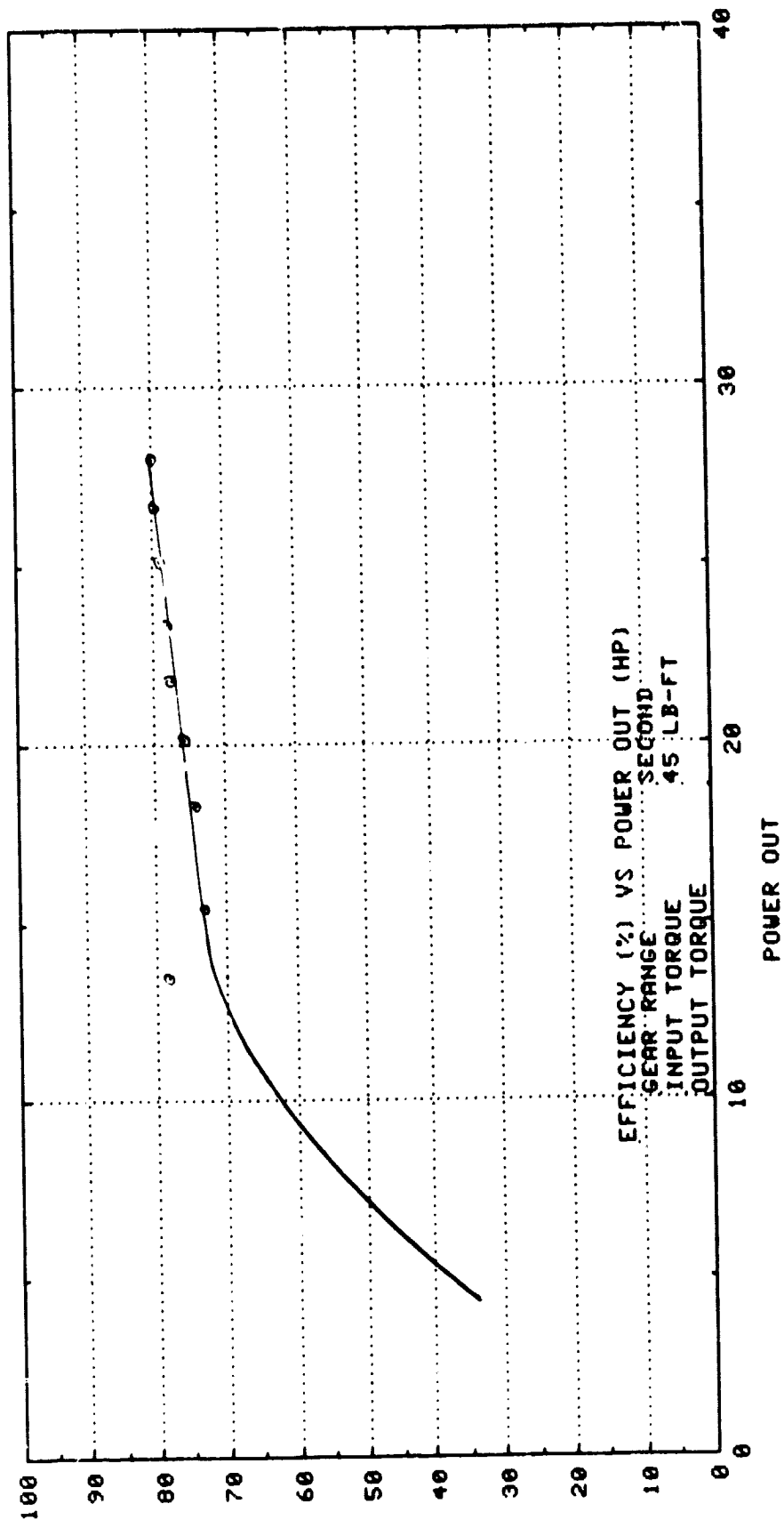

EFFICIENCY

TORQUE RATIO

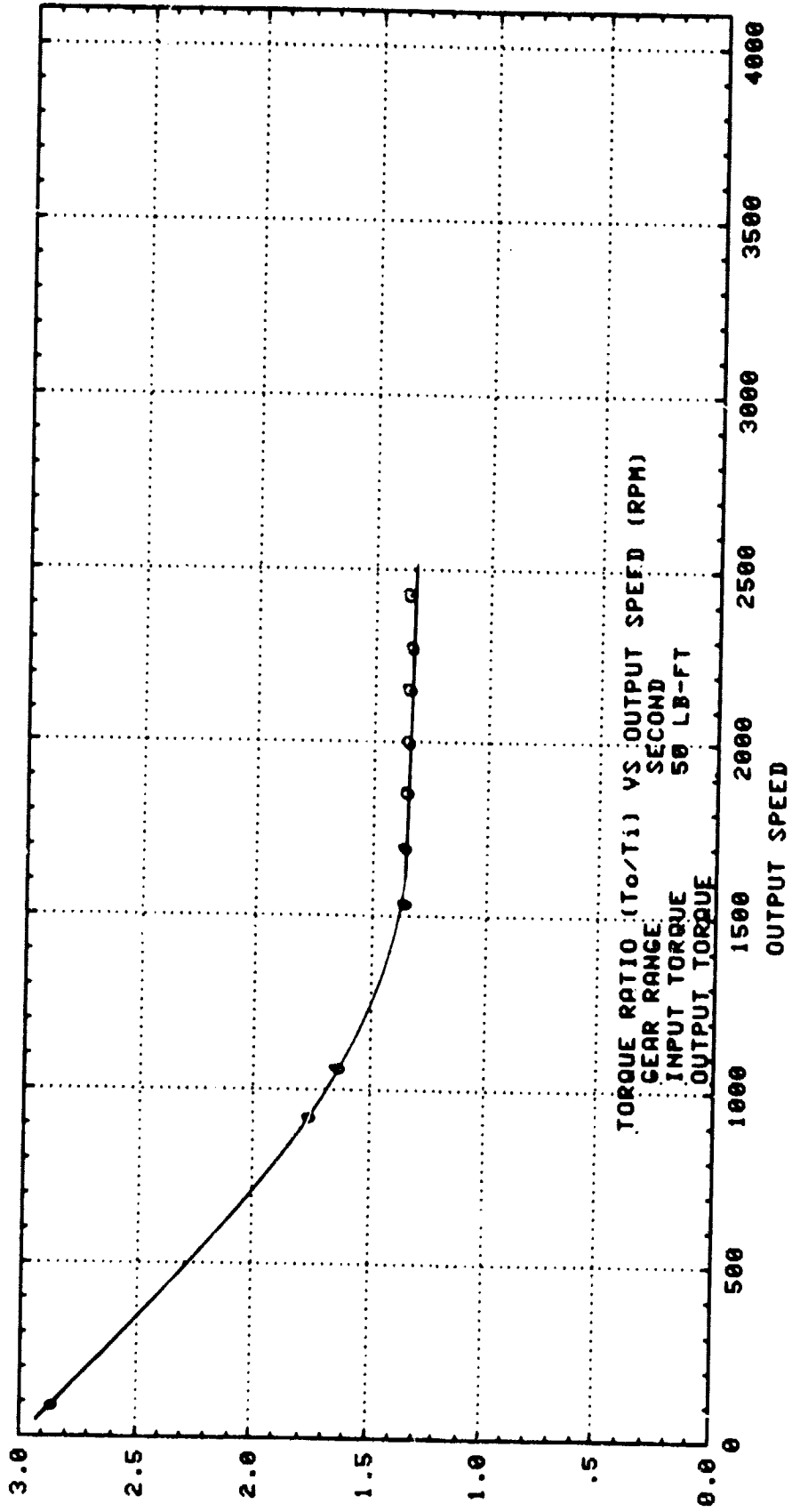

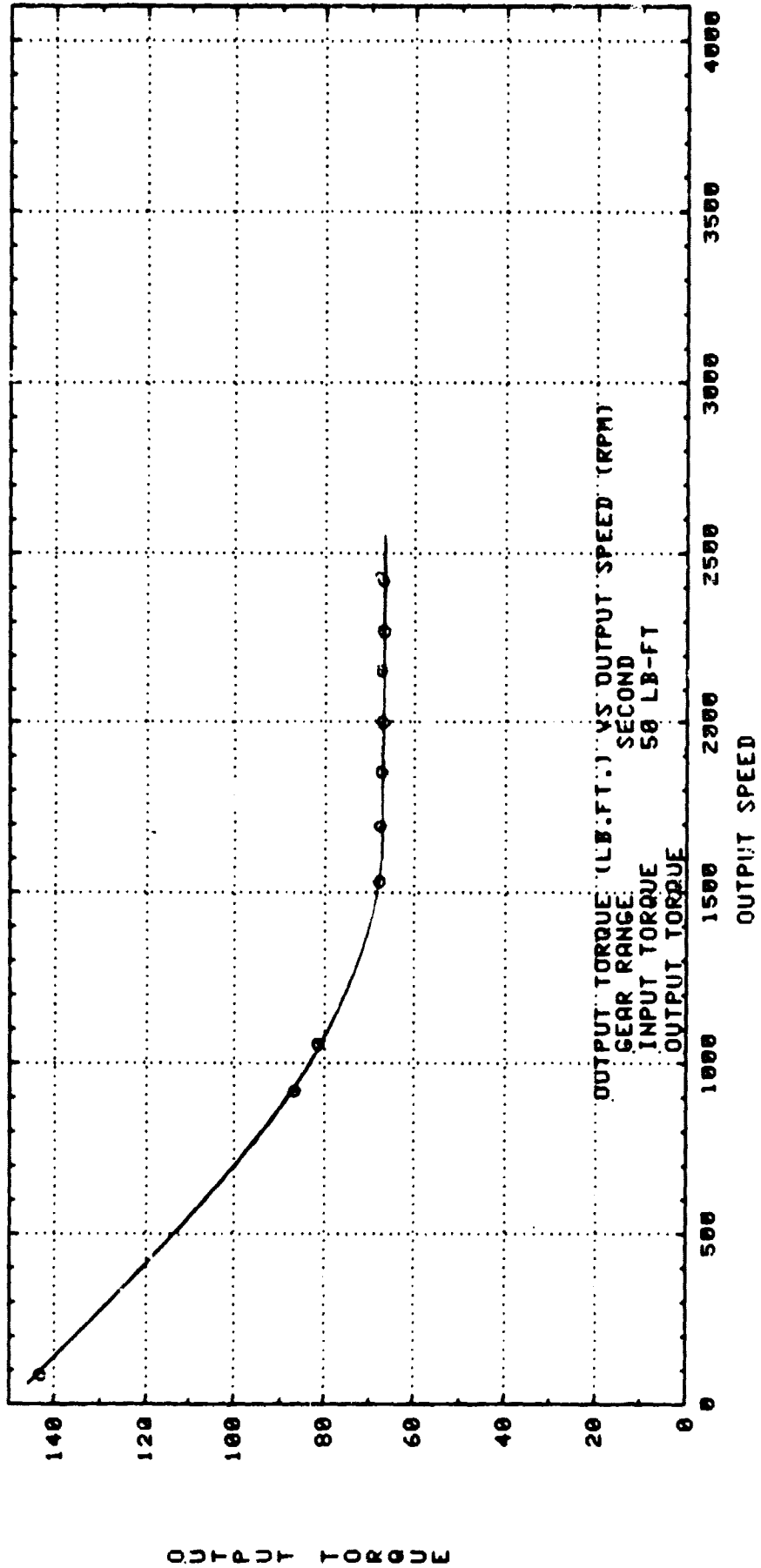

OUTPUT TORQUE

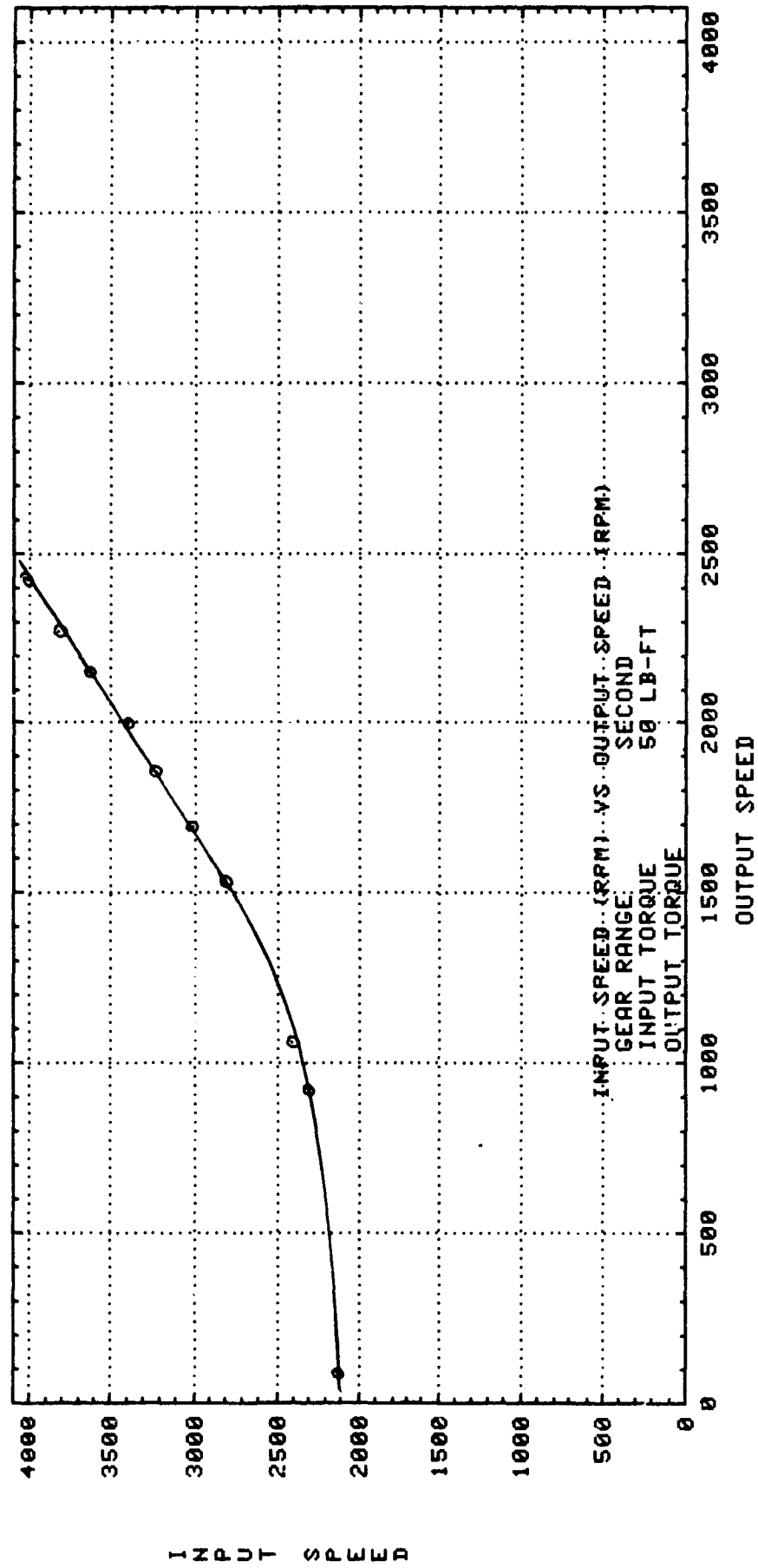



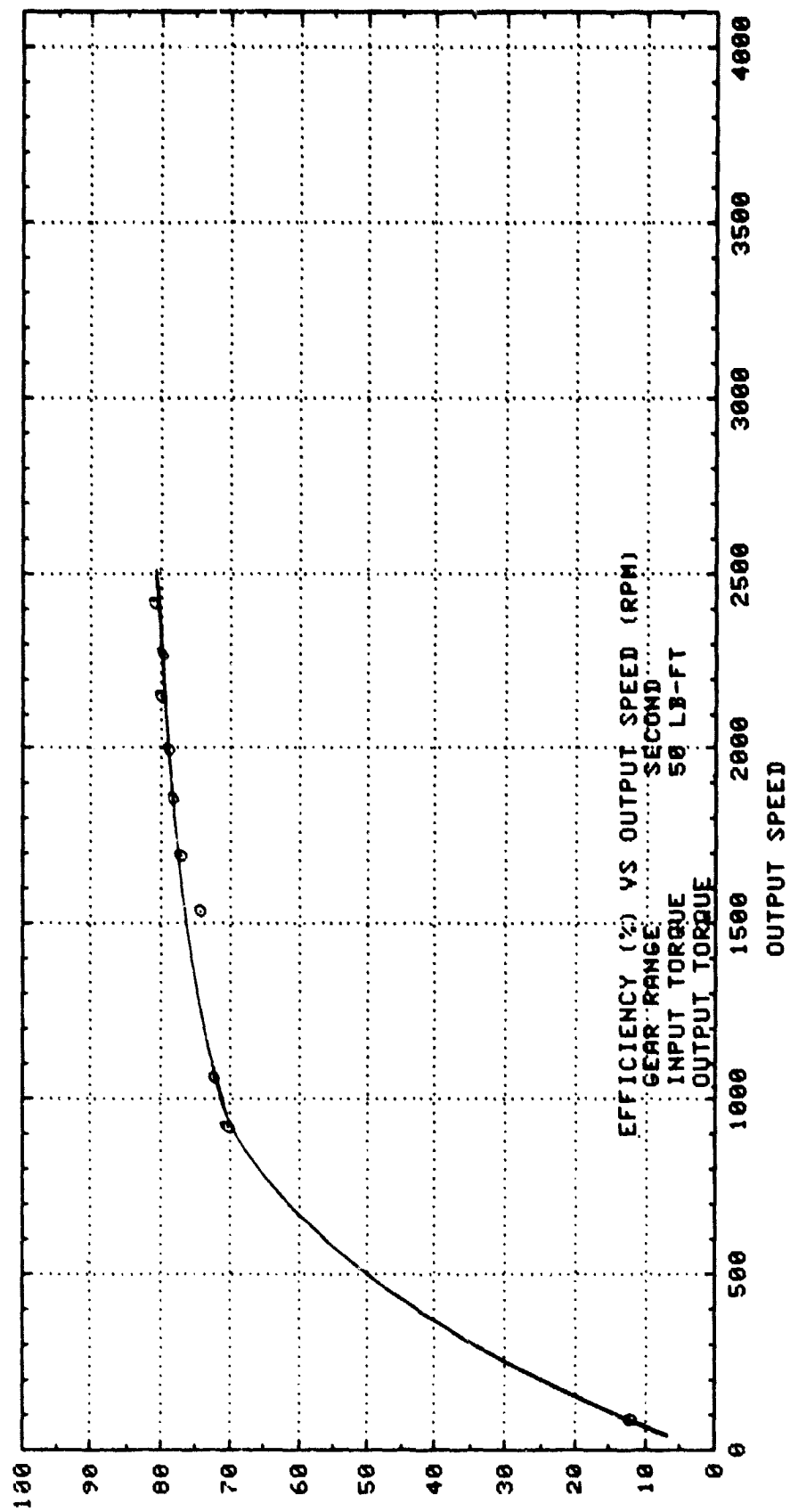

EFFICIENCY

E F F I C I E N C Y

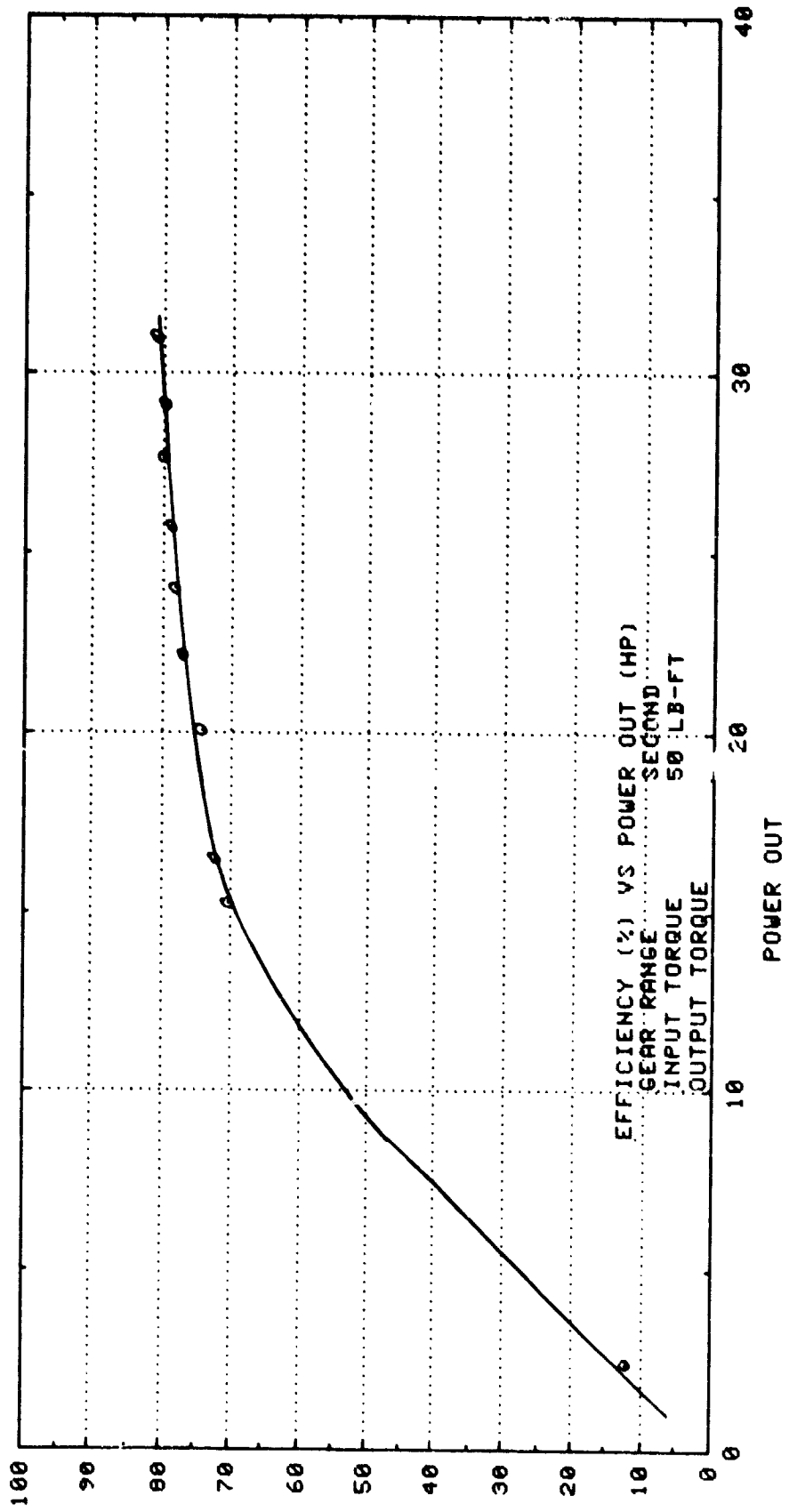

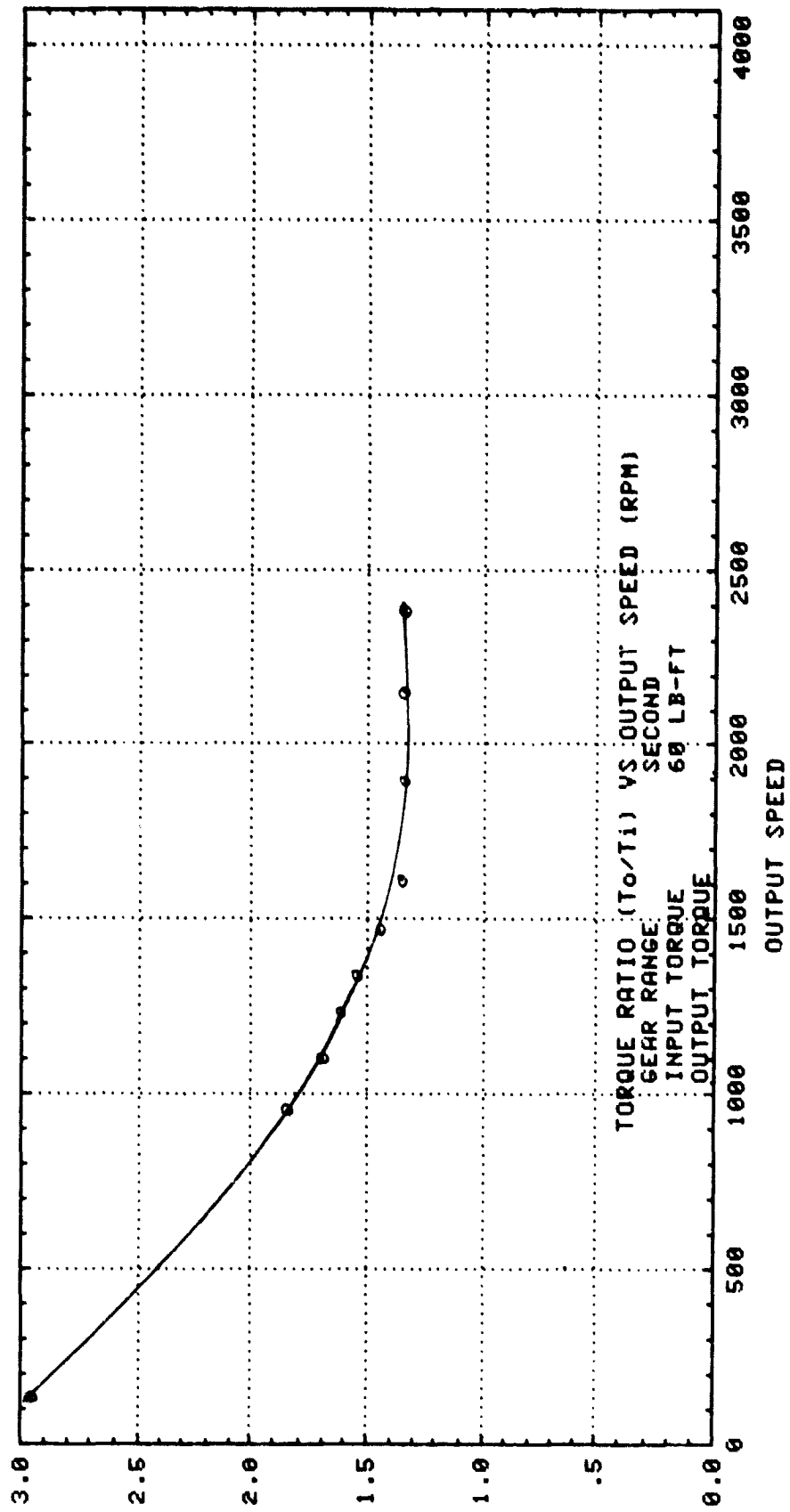

TORQUE RATIO

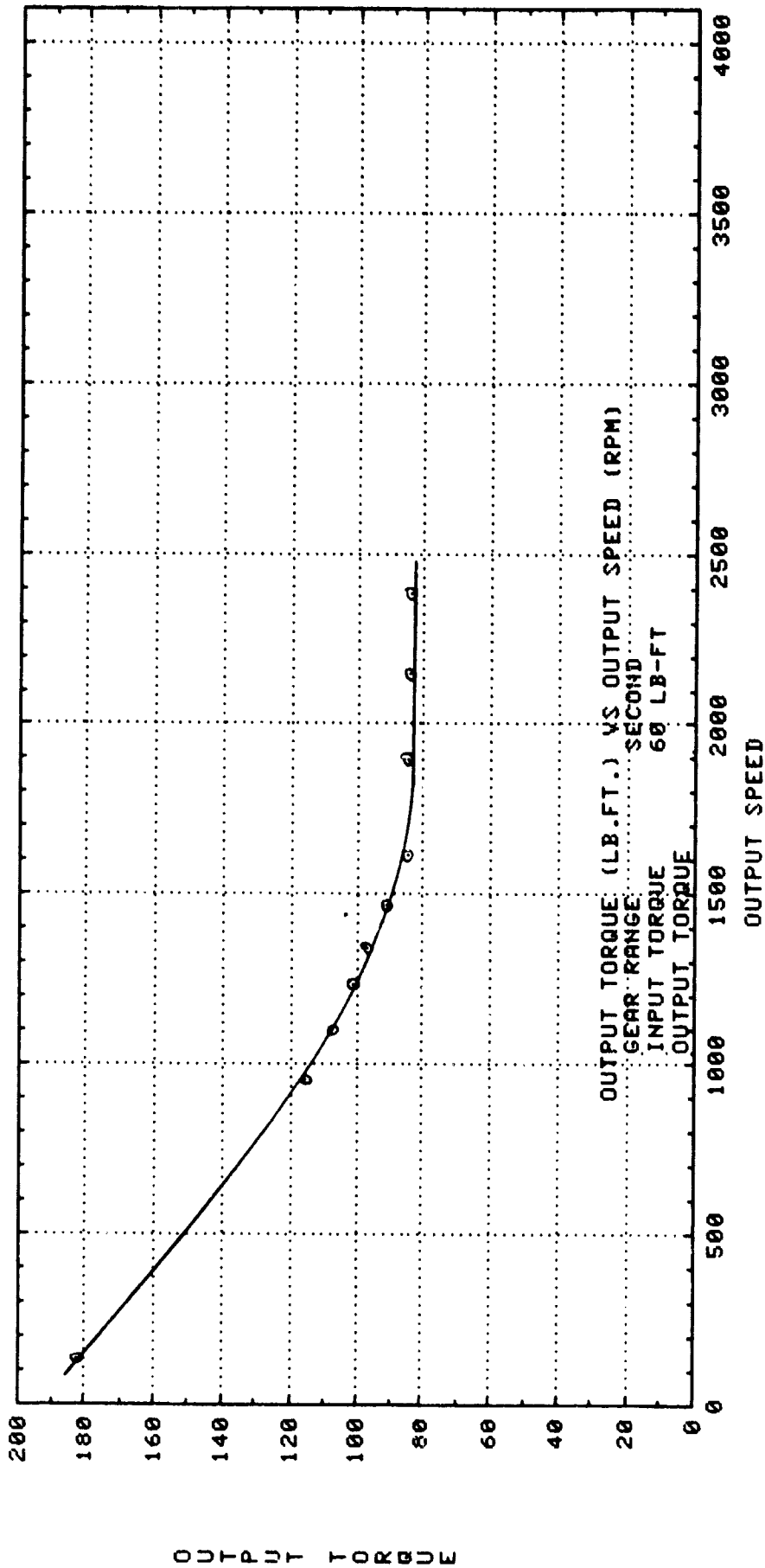

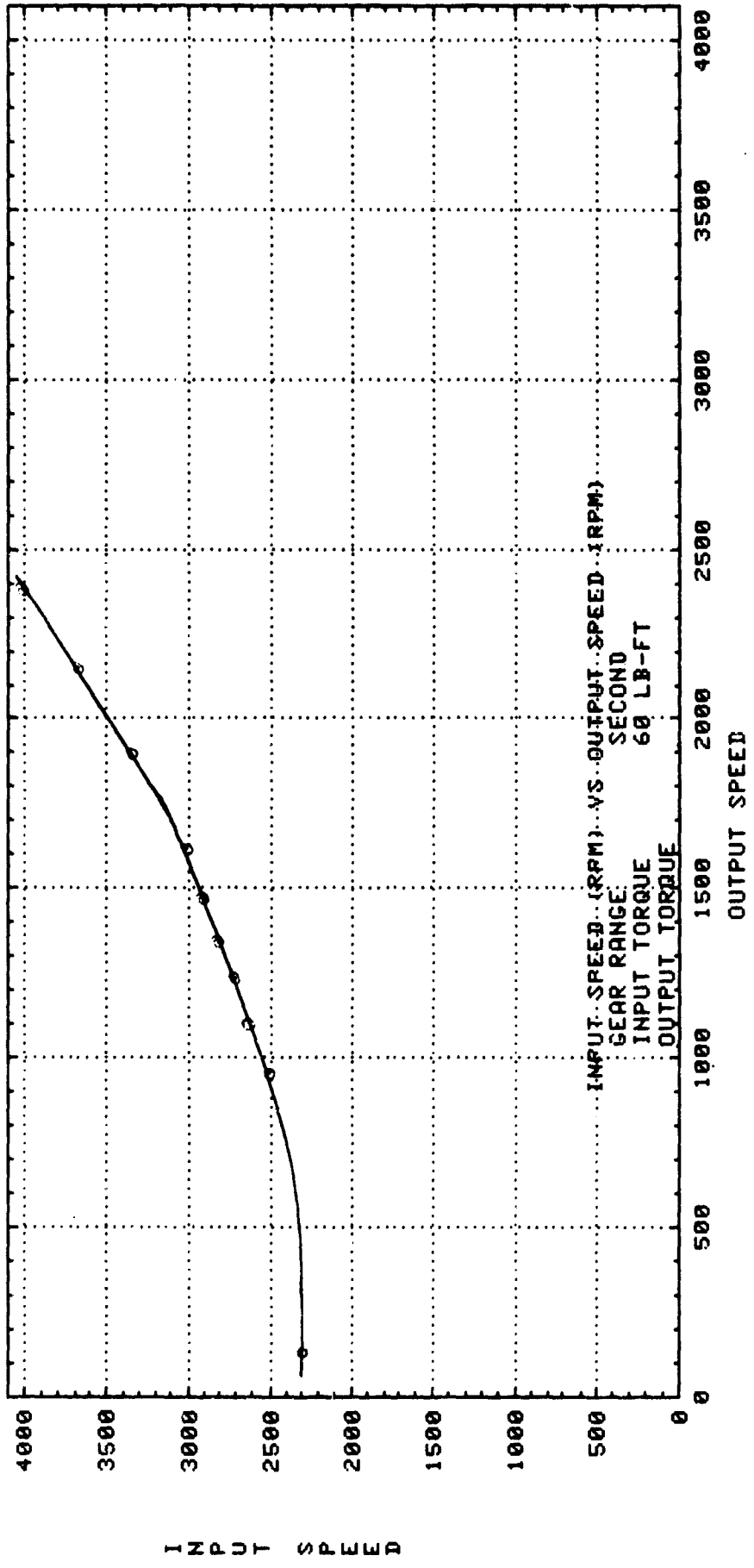

INPUT SPEED

EFFICIENCY

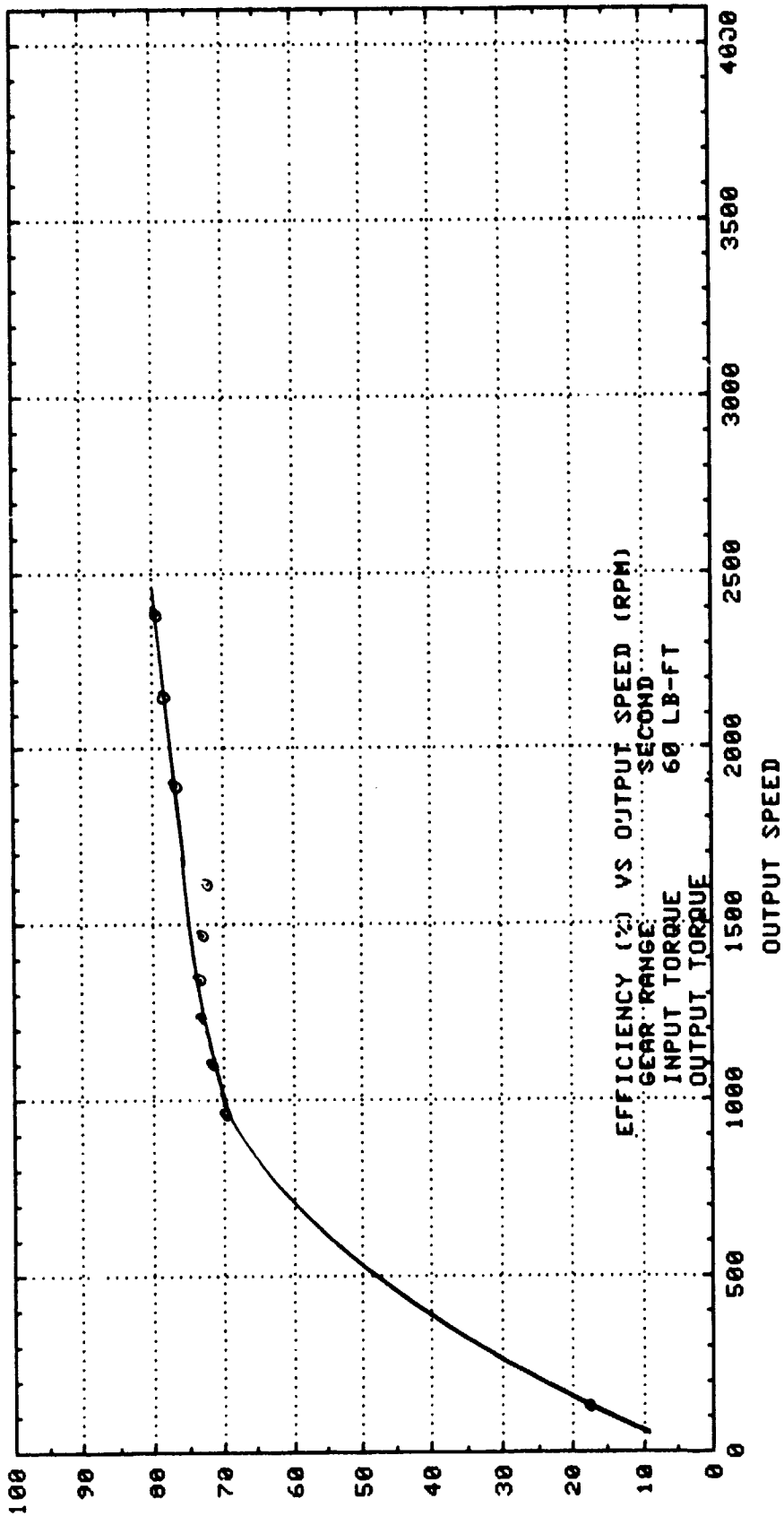

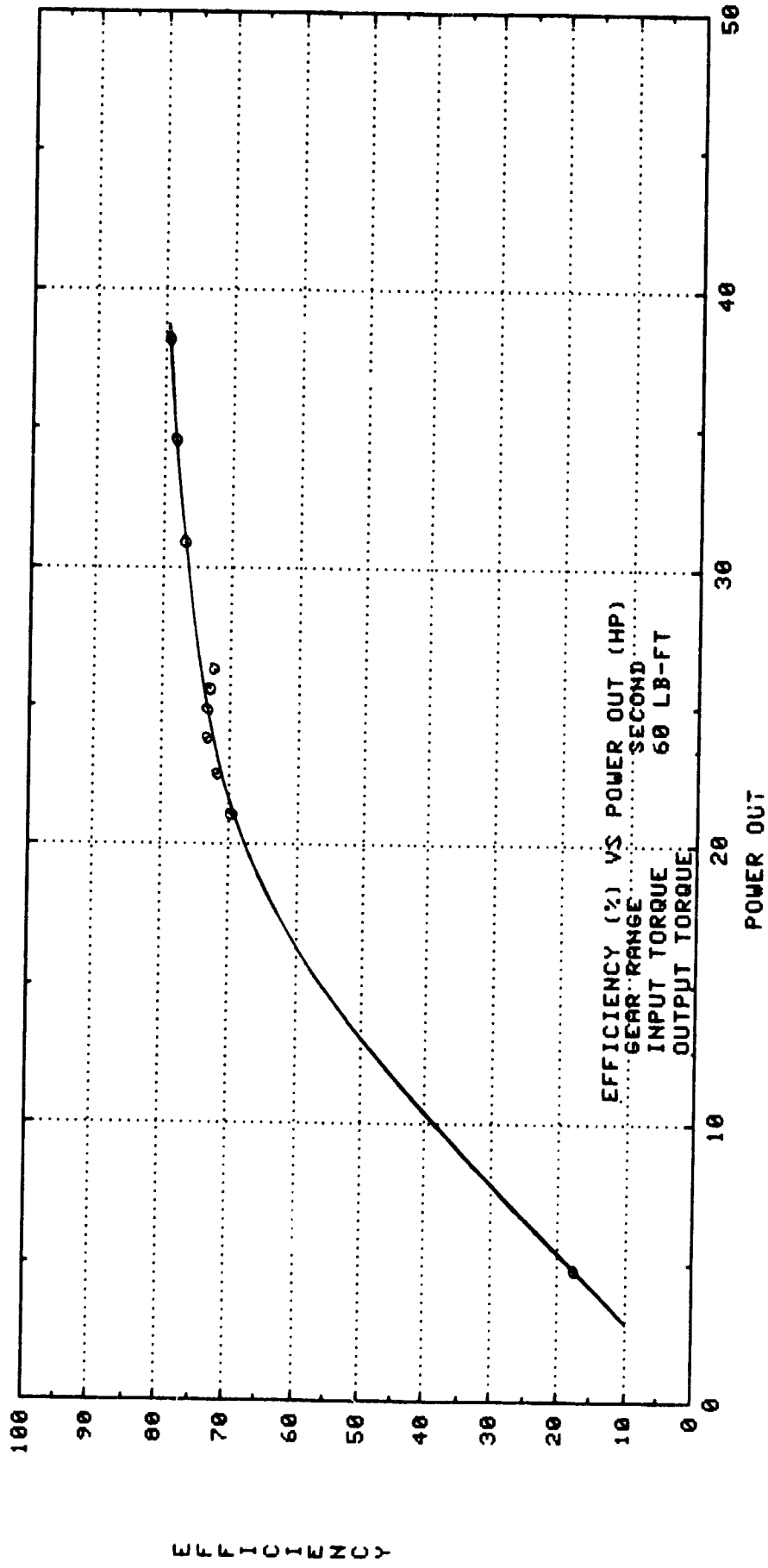

EFFICIENCY

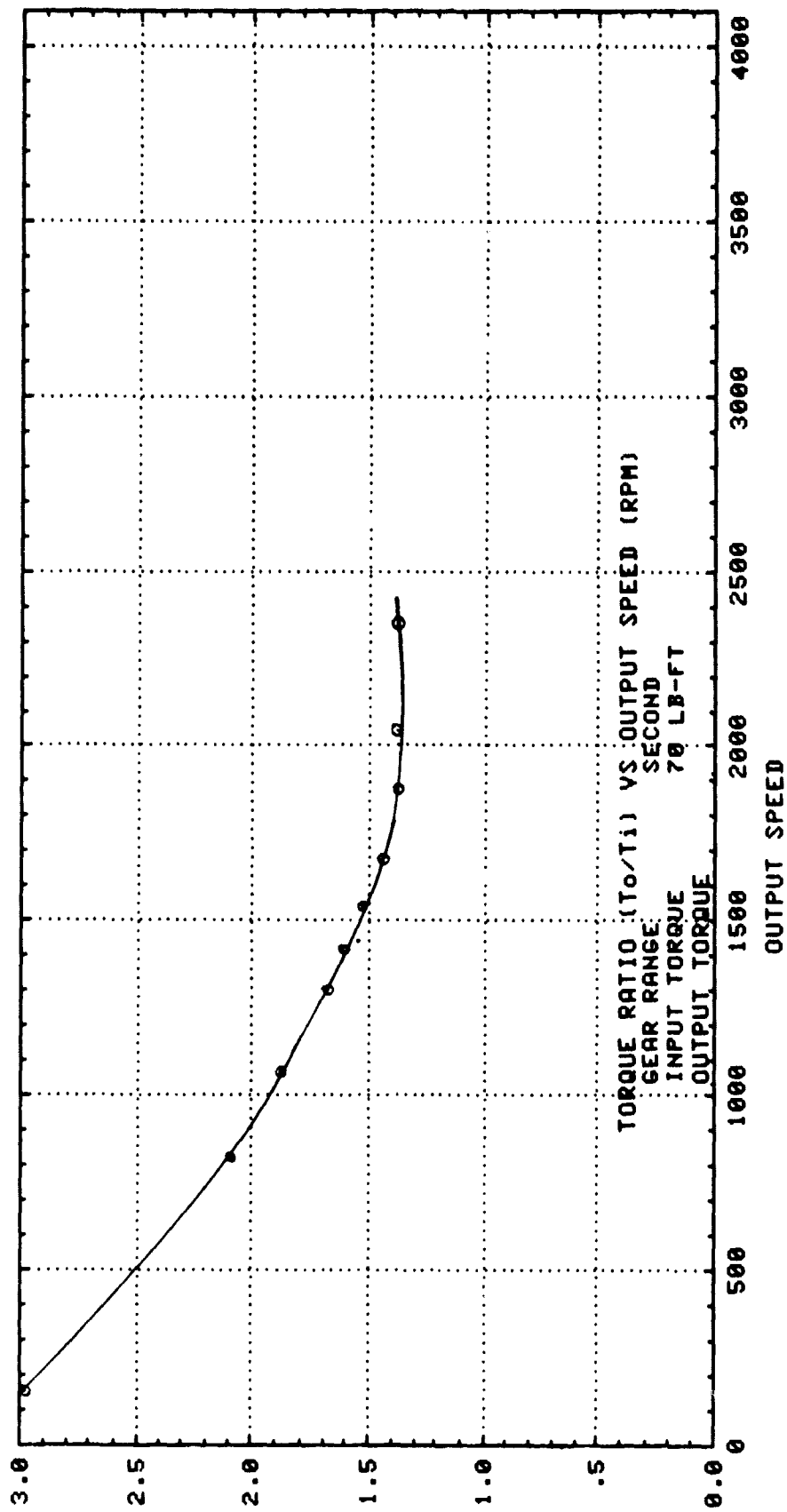



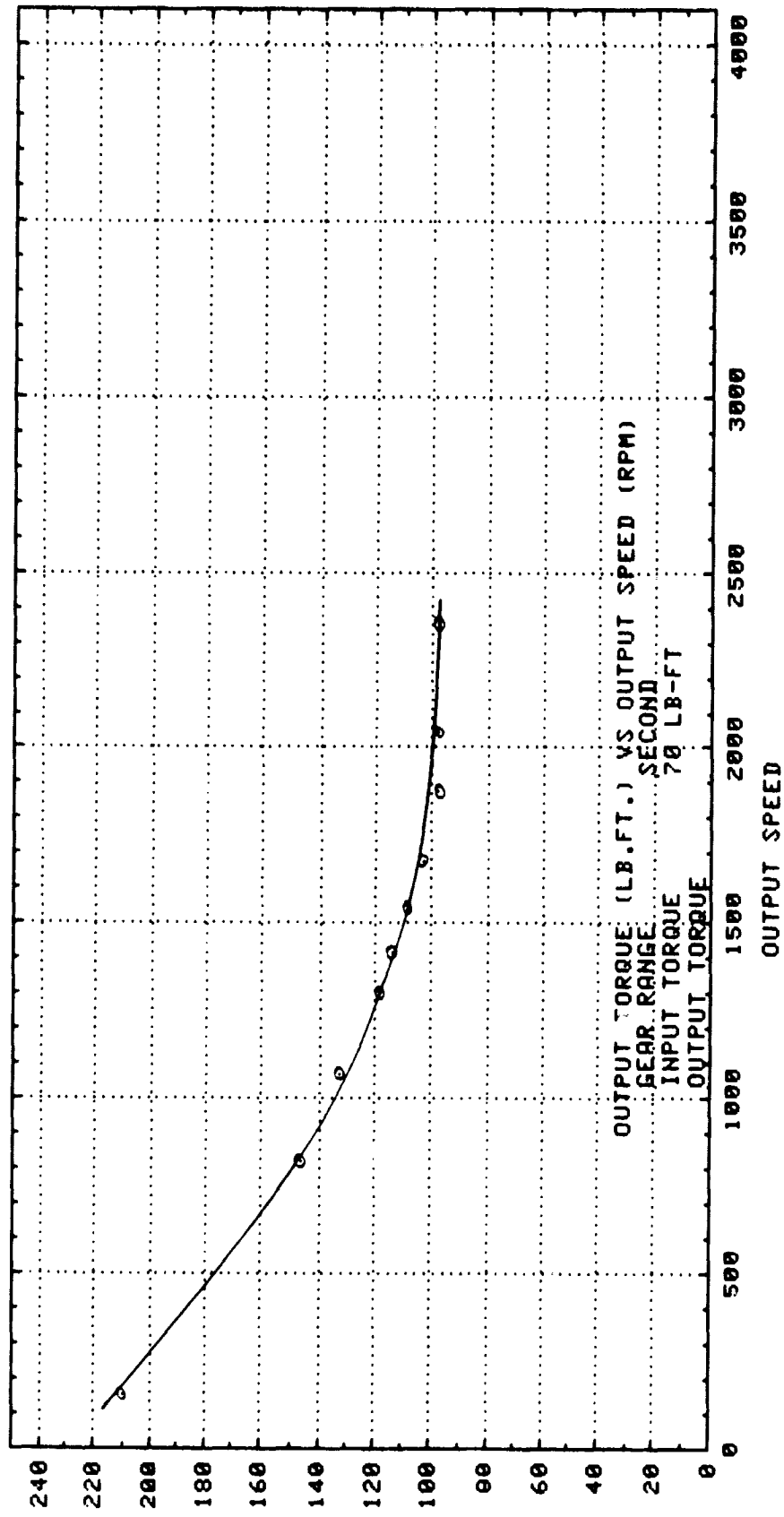

OUTPUT TORQUE

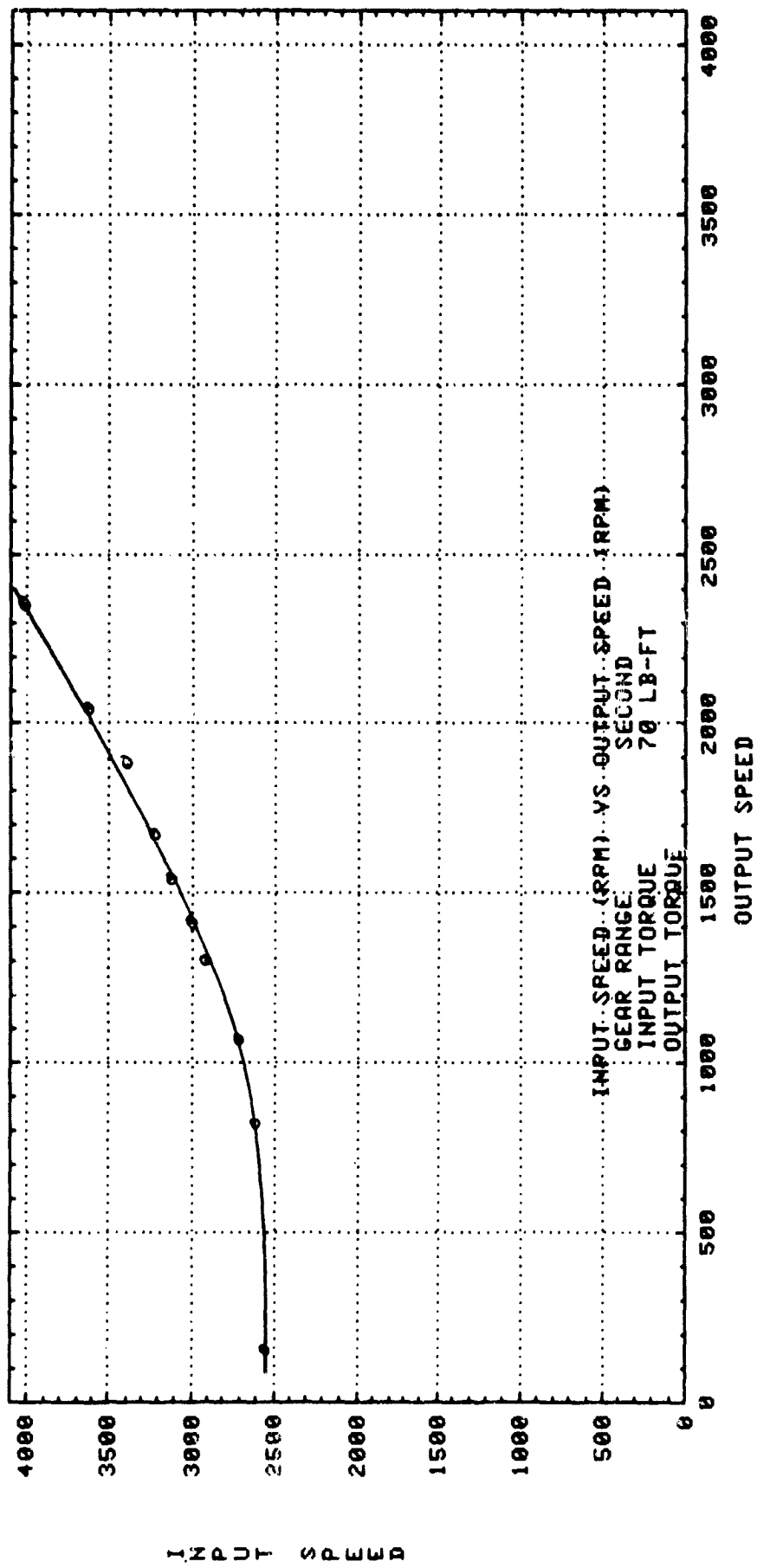

INPUT SPEED

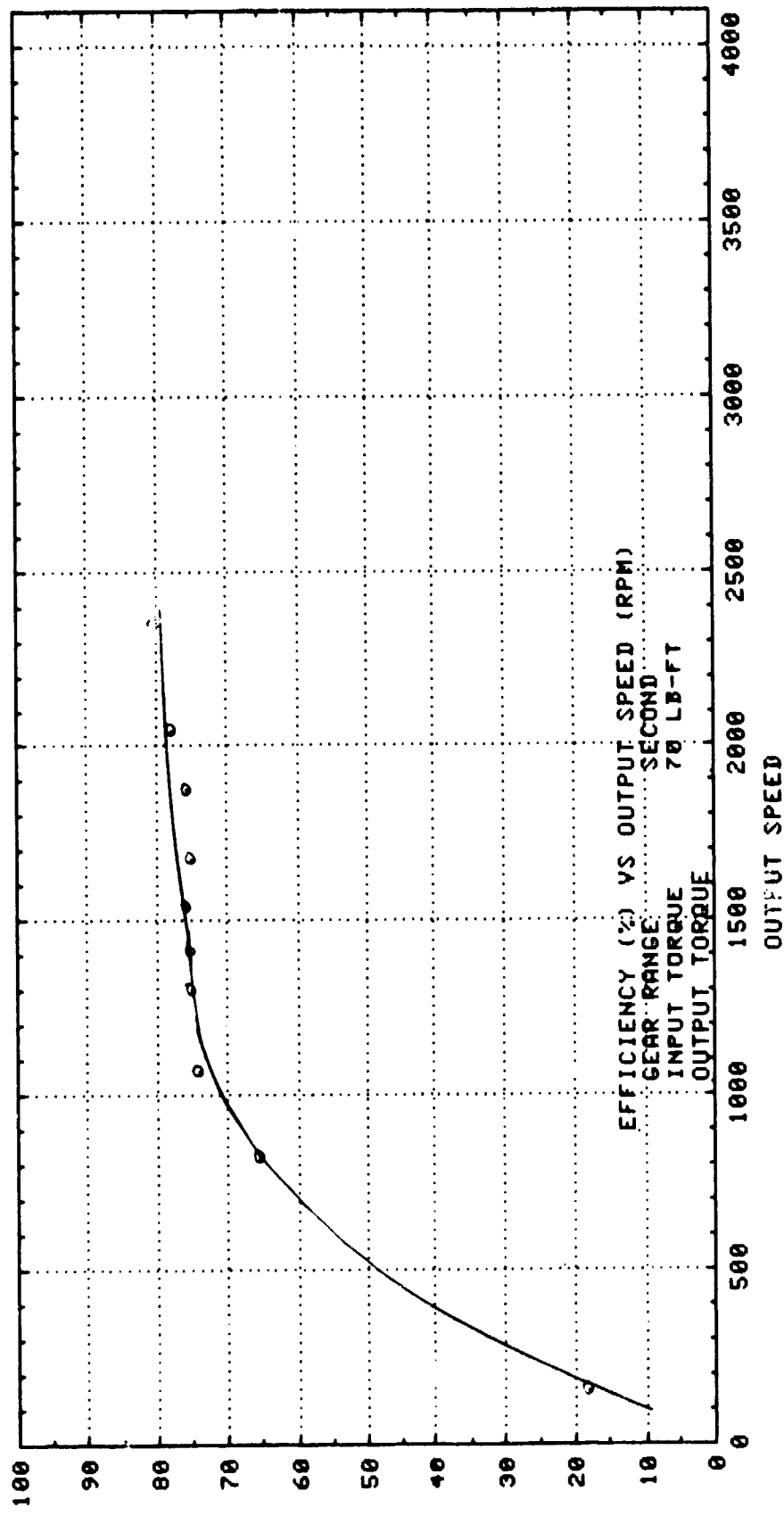

EFFICIENCY

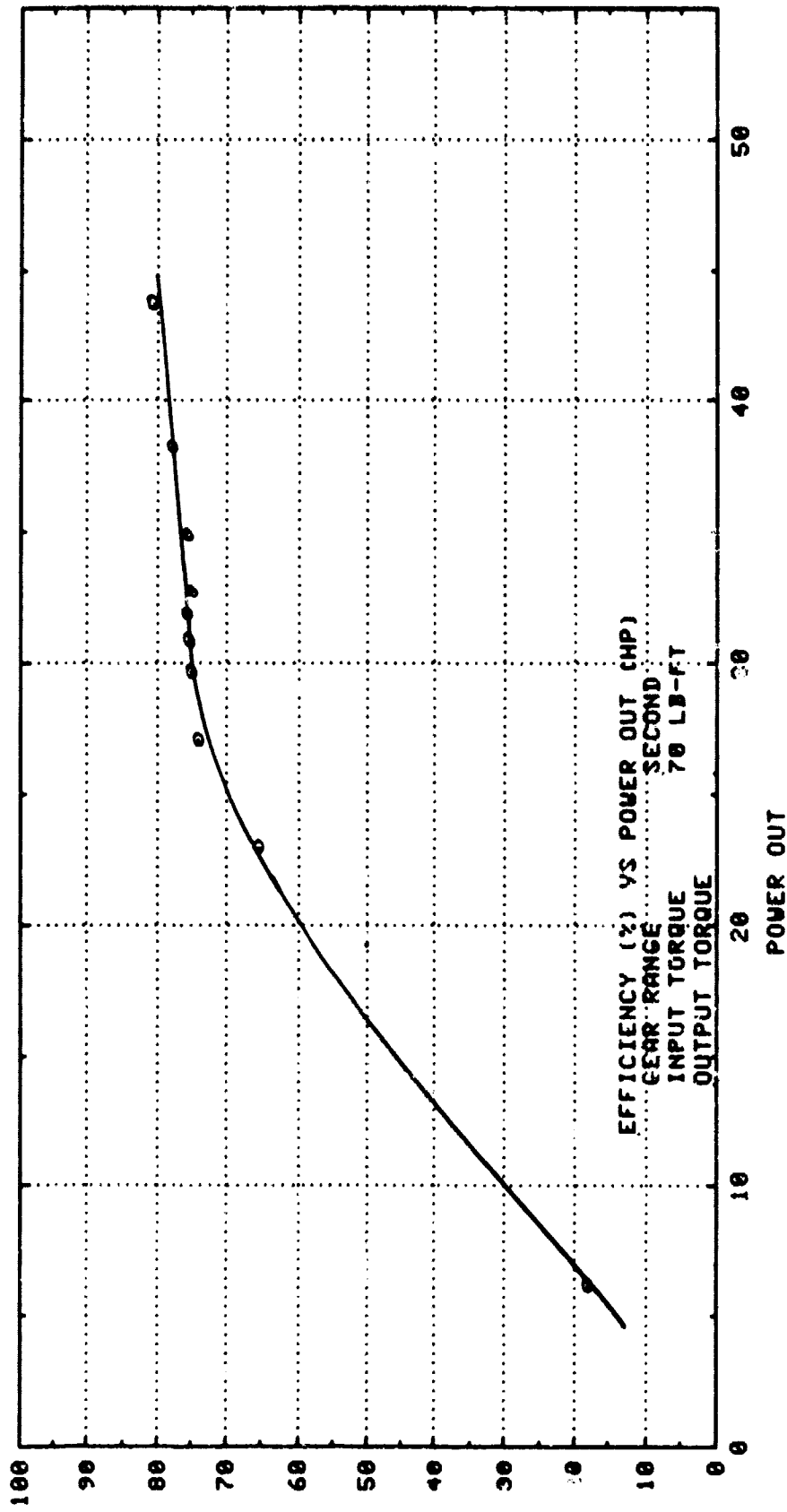

EFFICIENCY

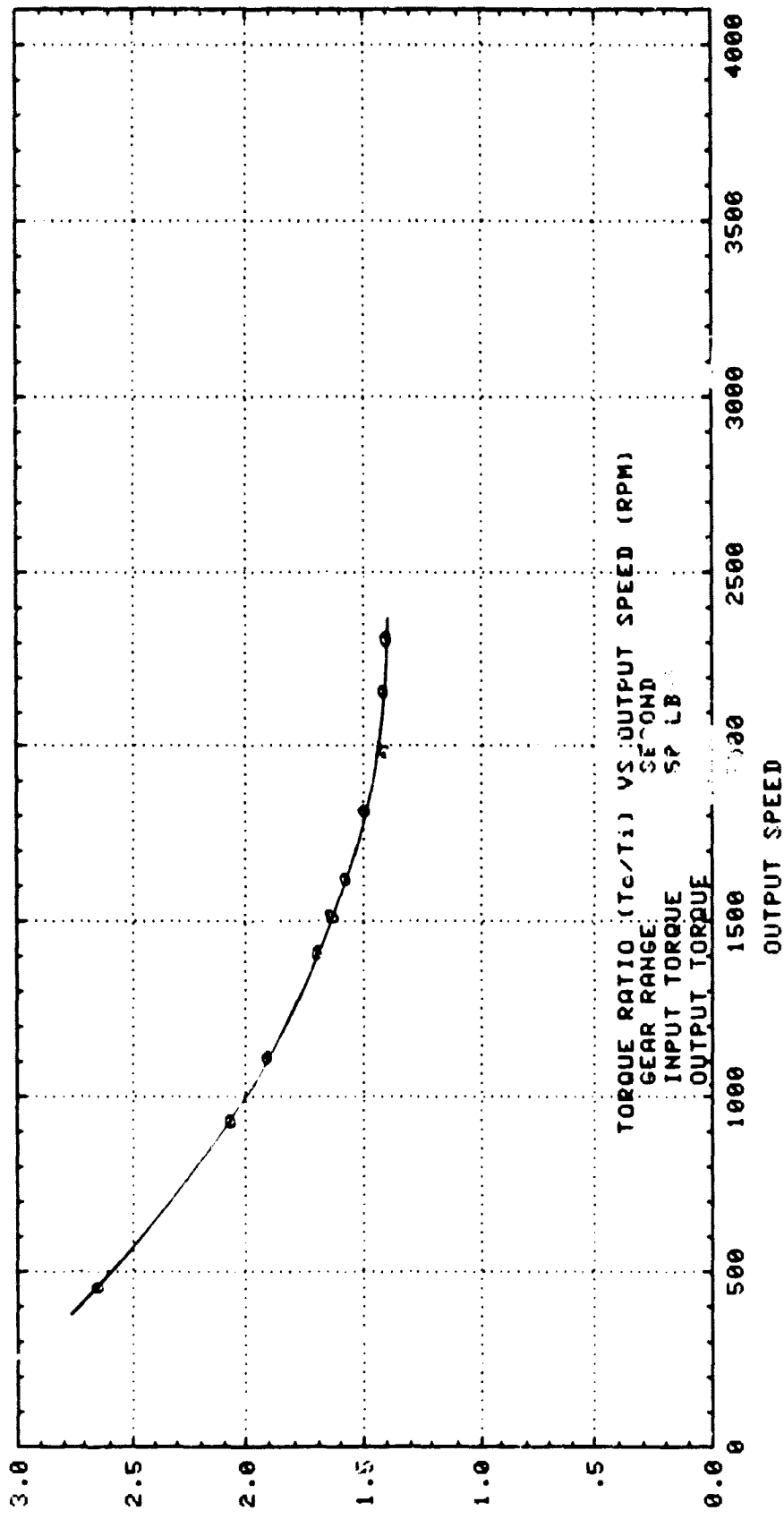

TORQUE RATIO

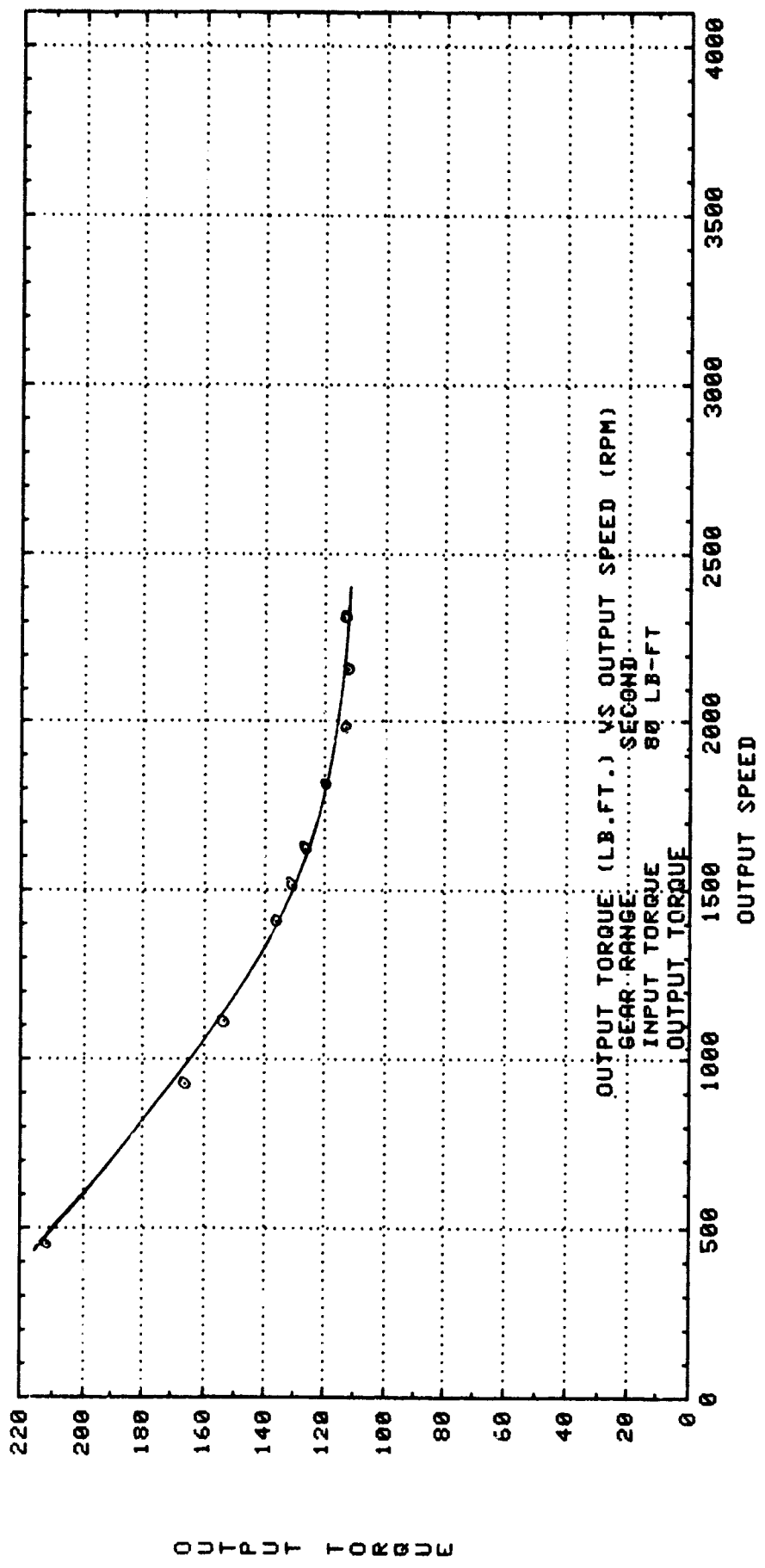

OUTPUT TORQUE

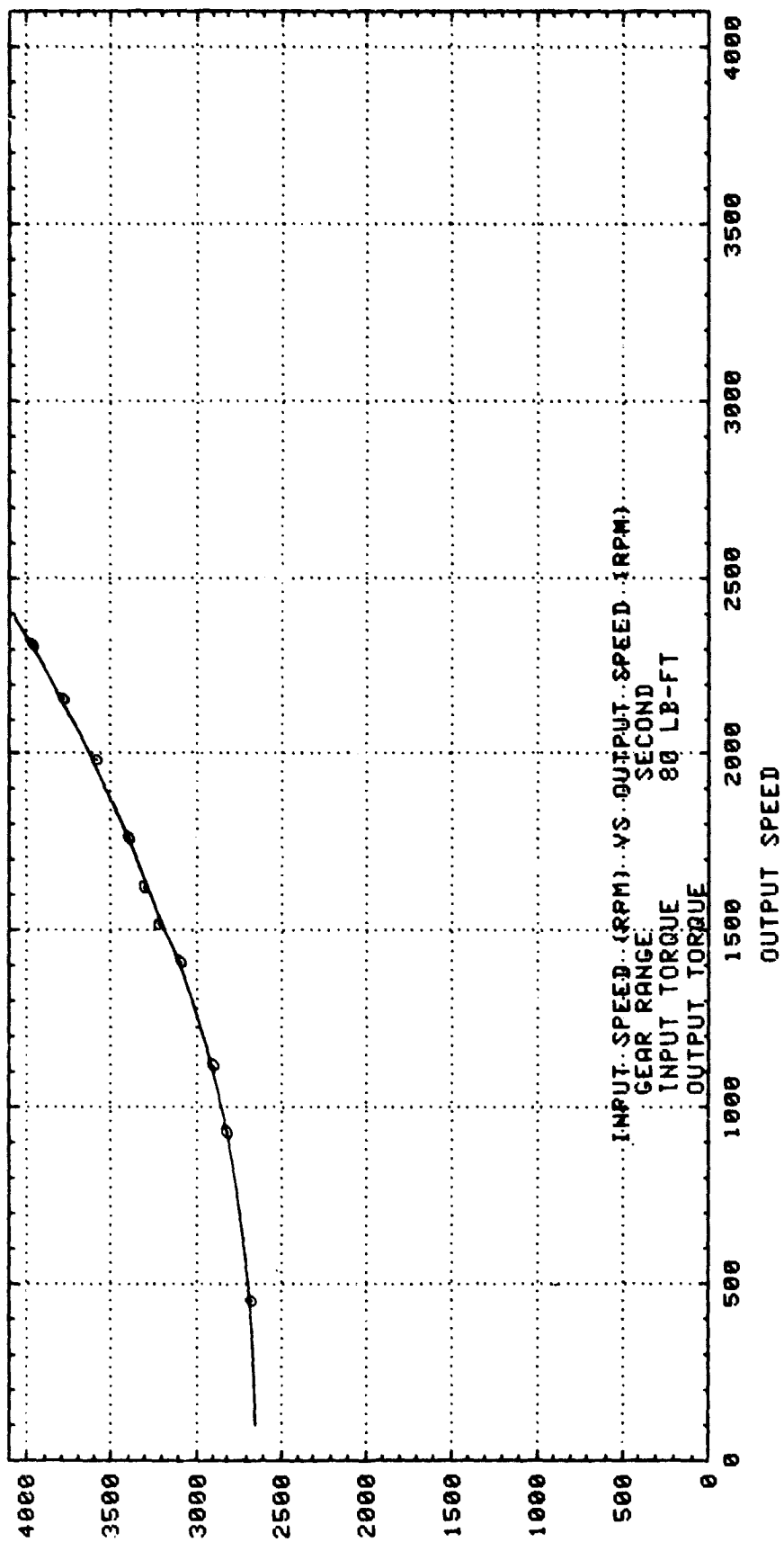

INPUT SPEED

EFFICIENCY

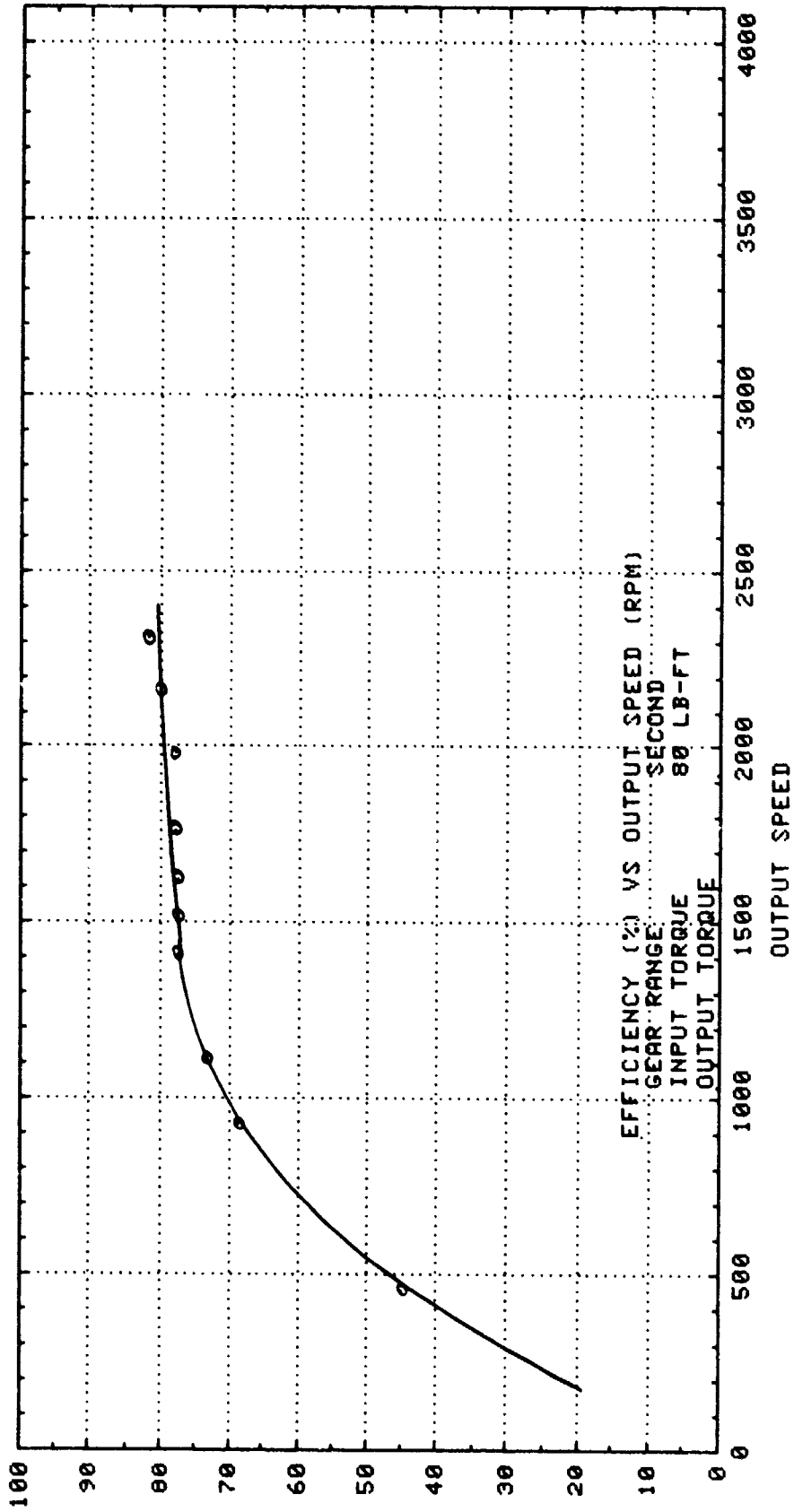



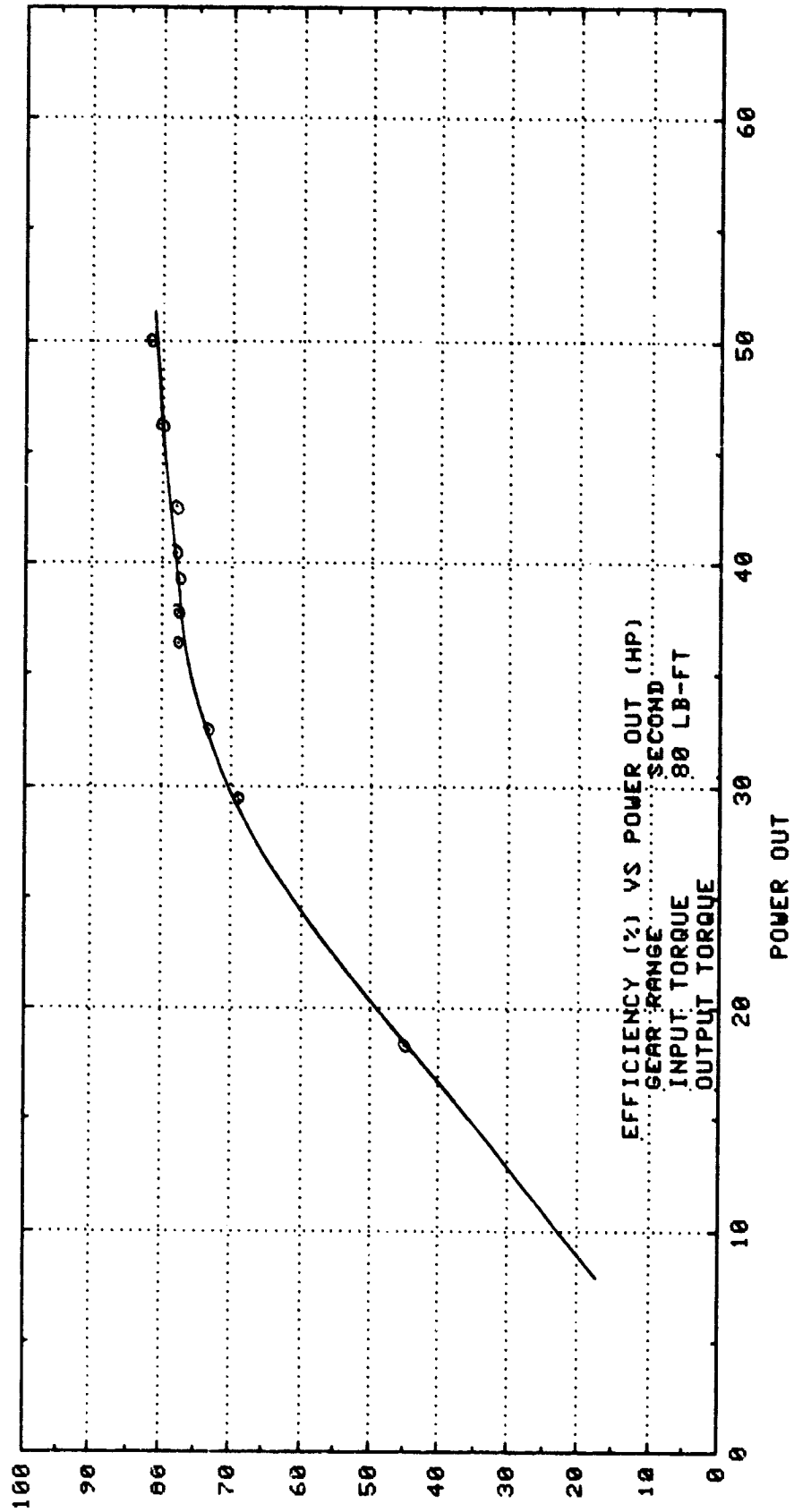

EFFICIENCY

TORQUE RATIO

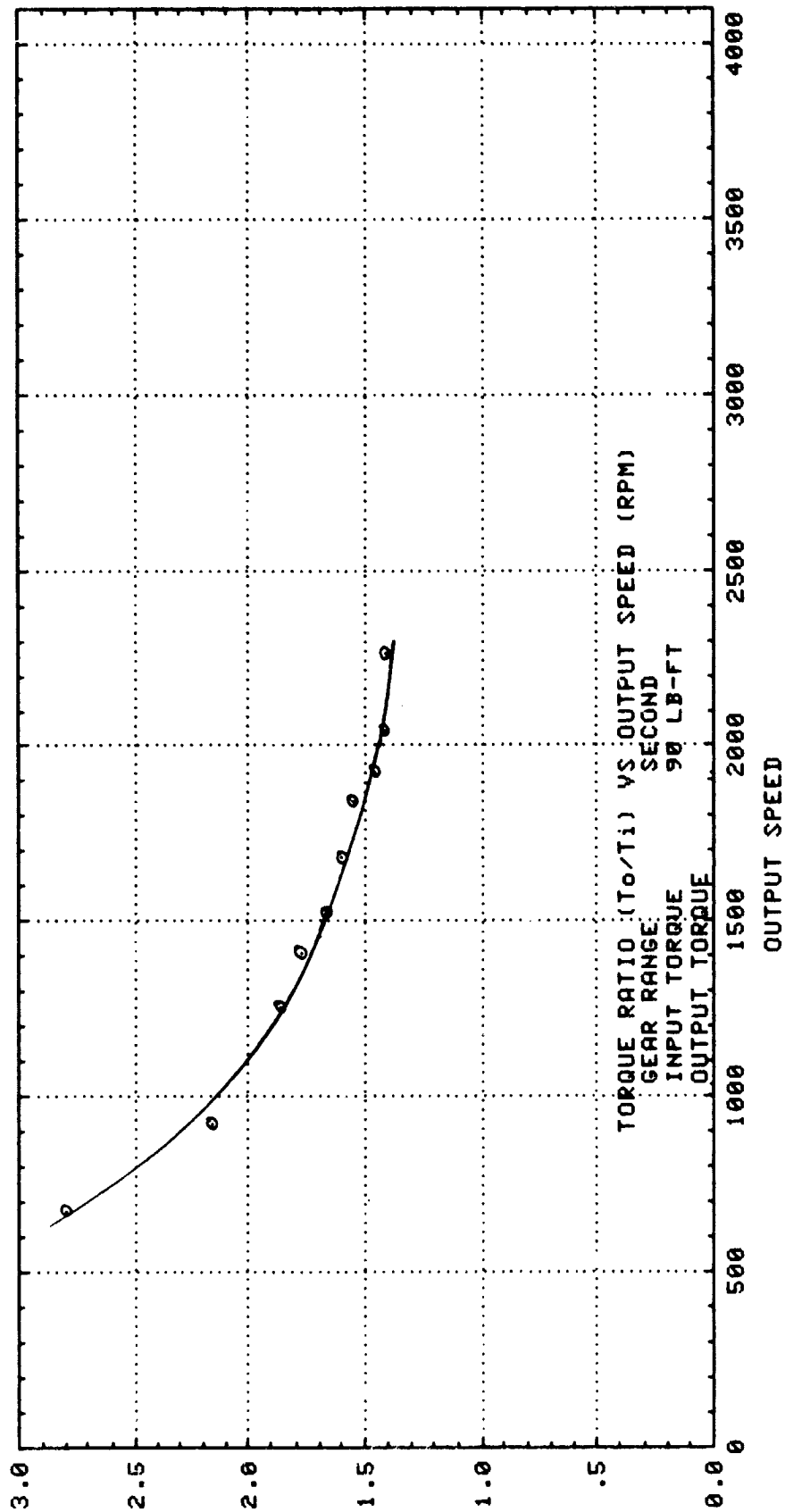

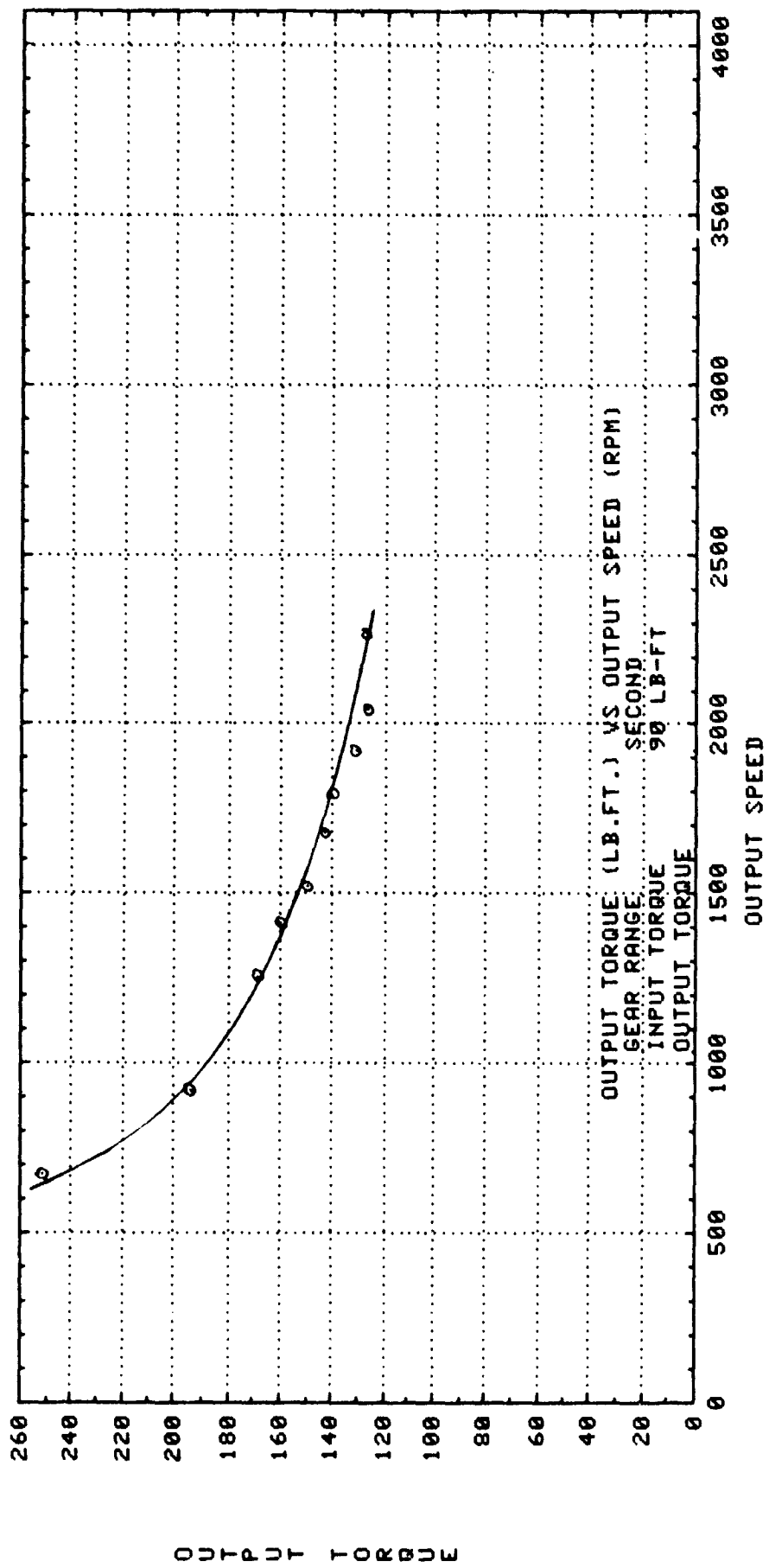

OUTPUT TORQUE

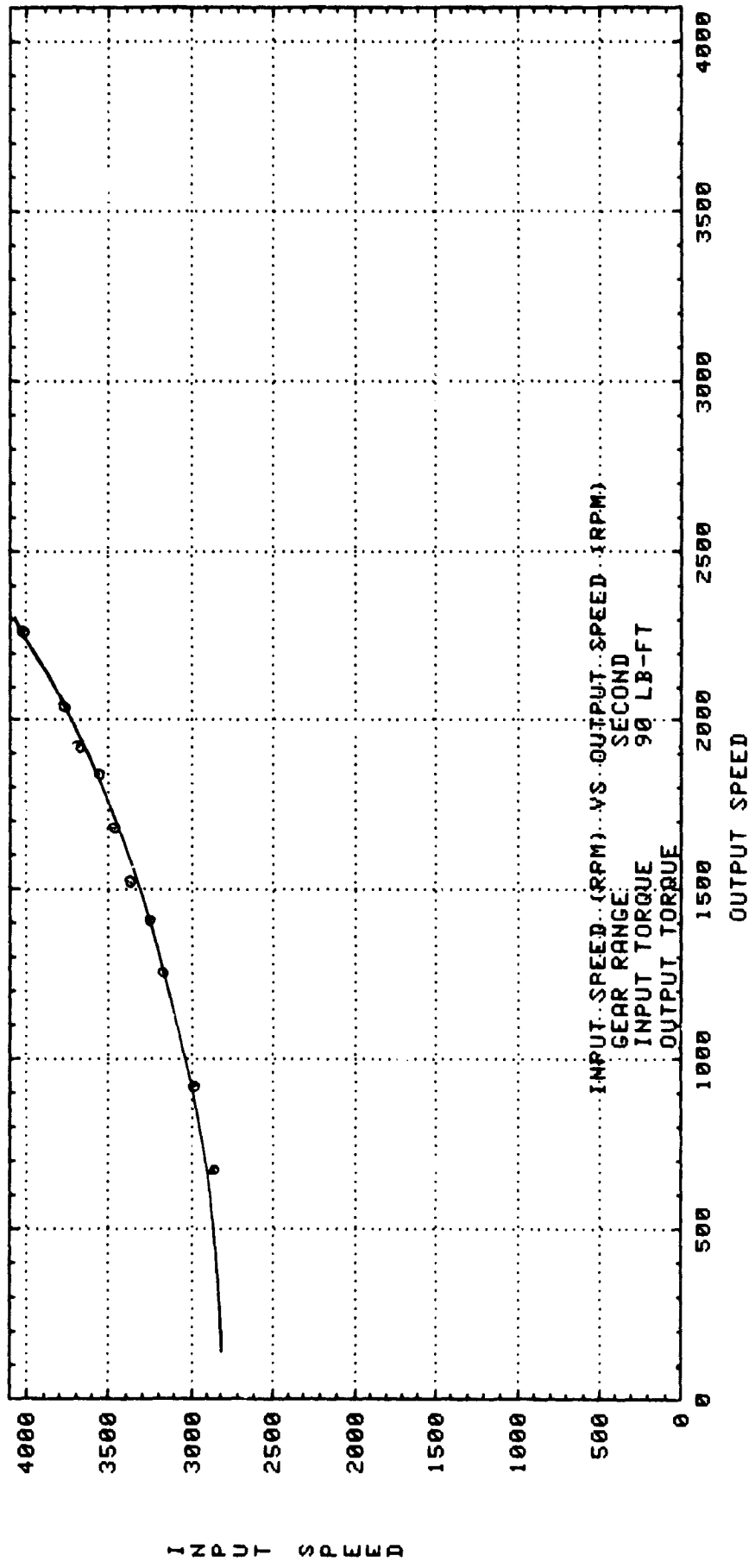

INPUT SPEED

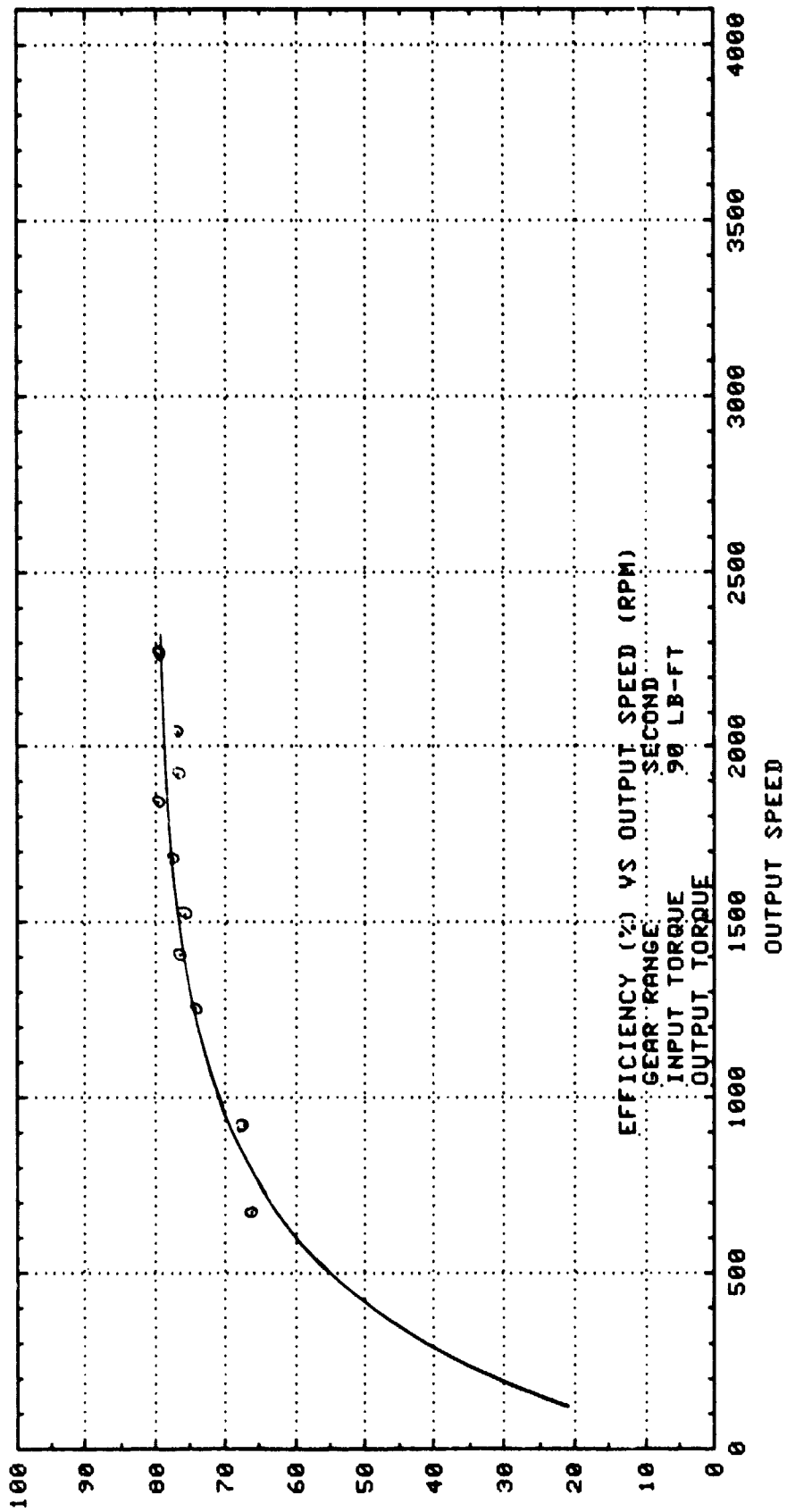

EFFICIENCY

EFFICIENCY

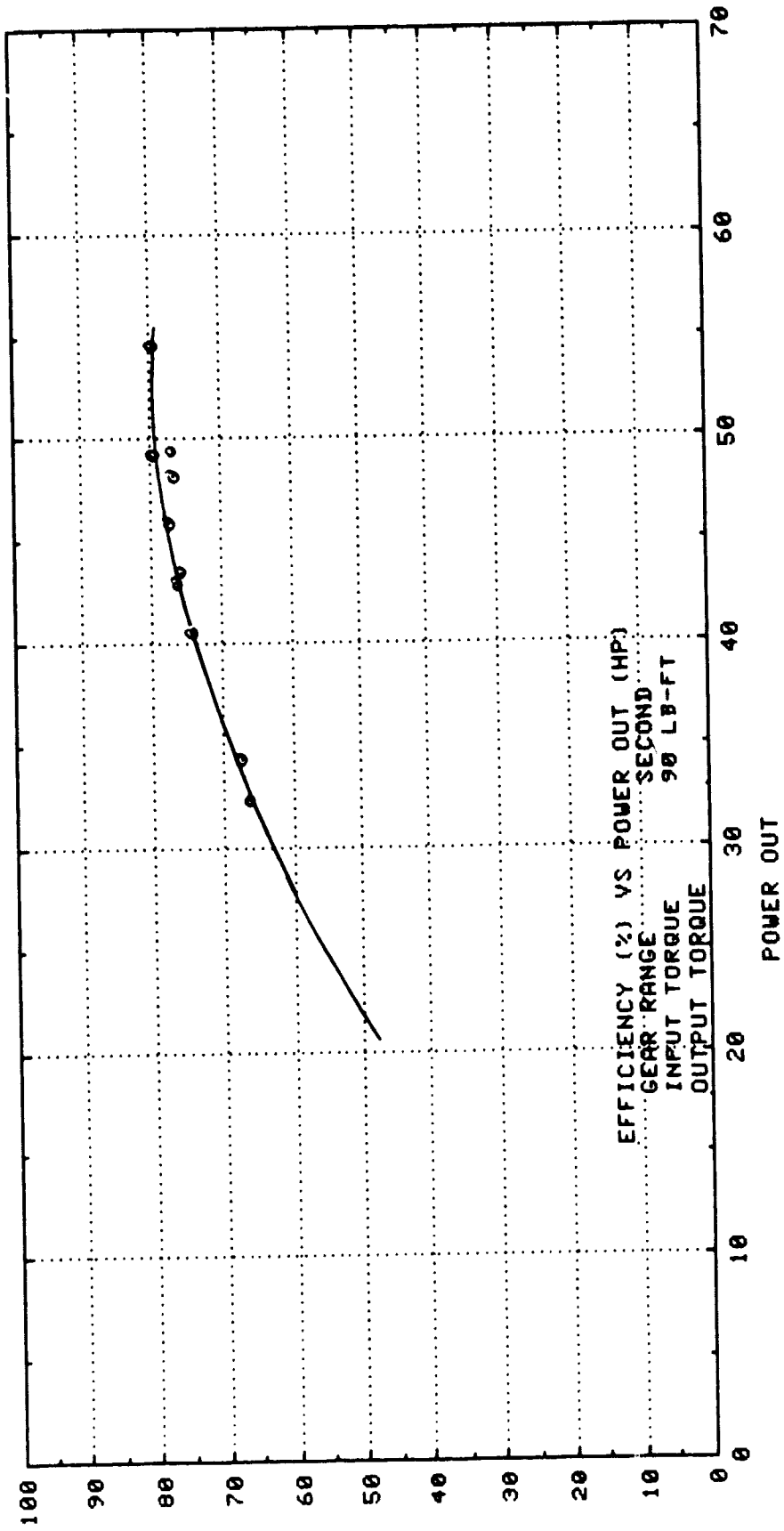

**DRIVE PERFORMANCE**

**3rd Gear**

Graphs Contained in This Section

- Torque Ratio -vs- Output Speed
- Output Torque -vs- Output Speed
- Input Speed -vs- Output Speed
- Efficiency -vs- Output Speed
- Efficiency -vs- Power Out

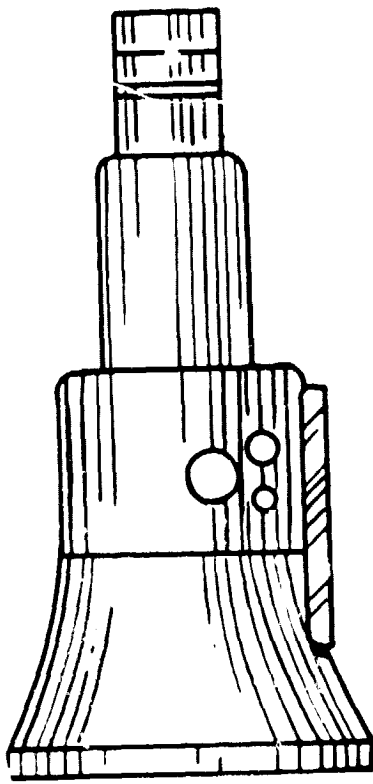

Torque In  
Speed In

Torque Out  
Speed Out

---

**Drive Performance Tests**



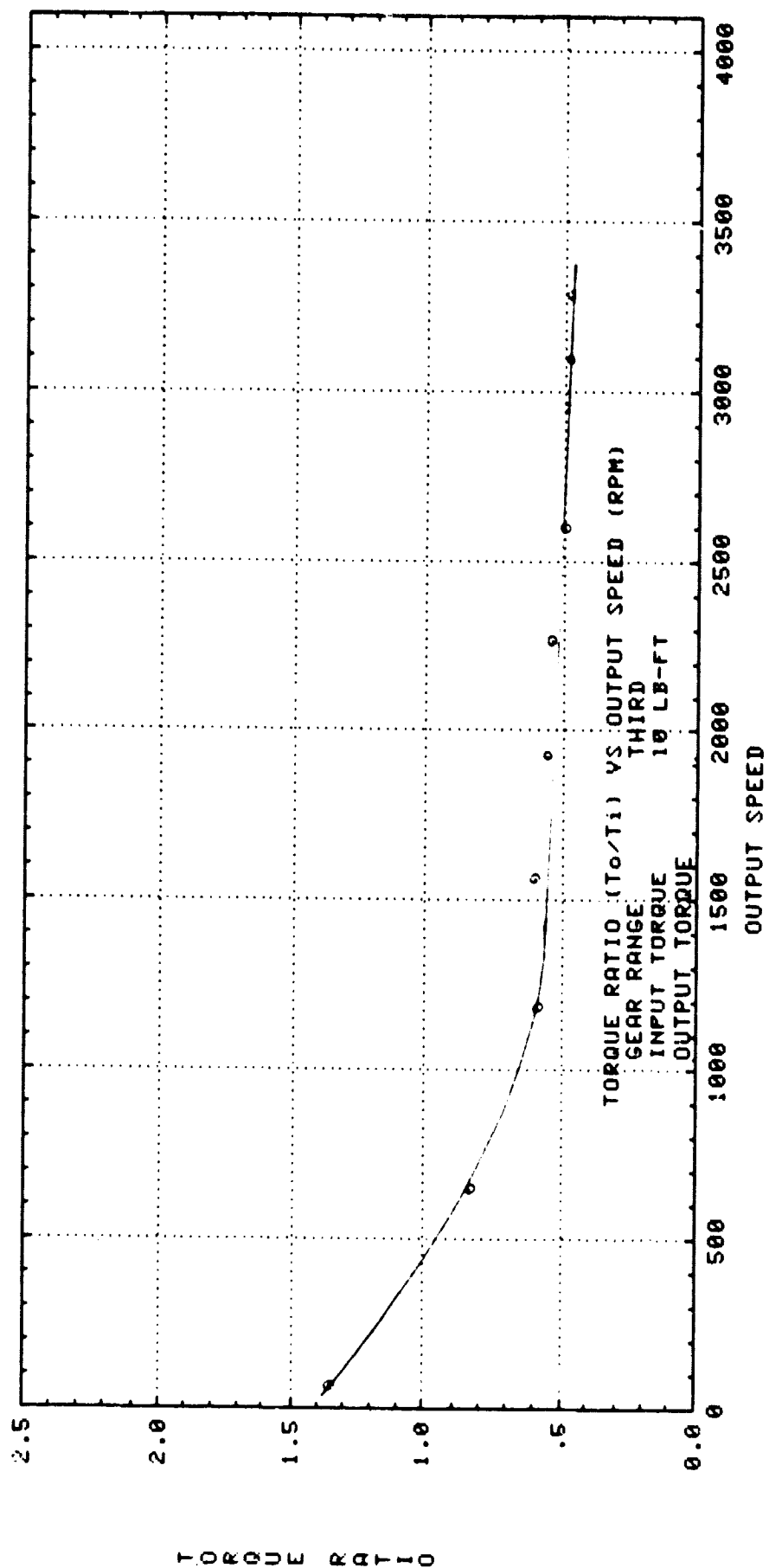

TORQUE RATIO

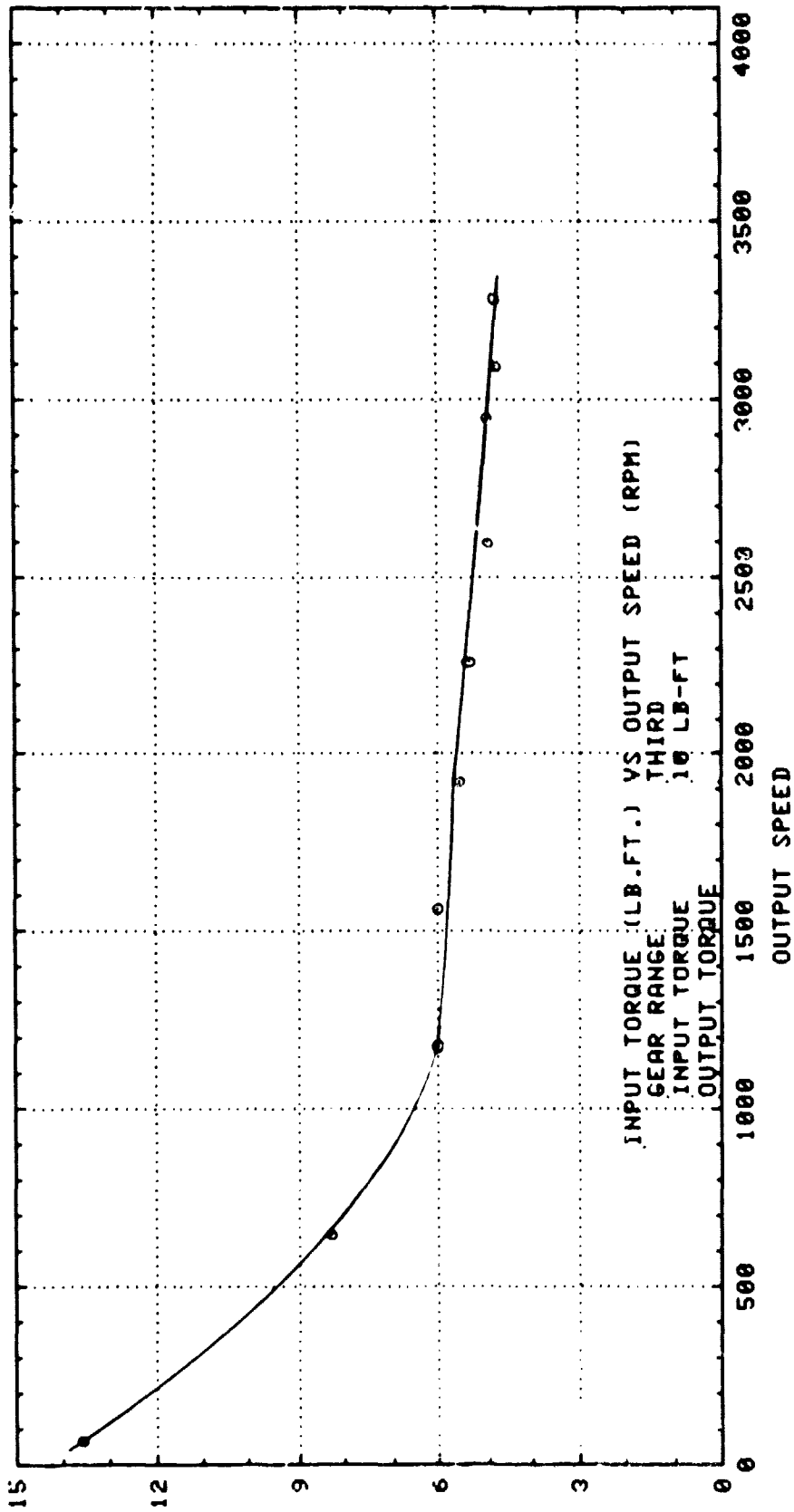

OUTPUT TORQUE

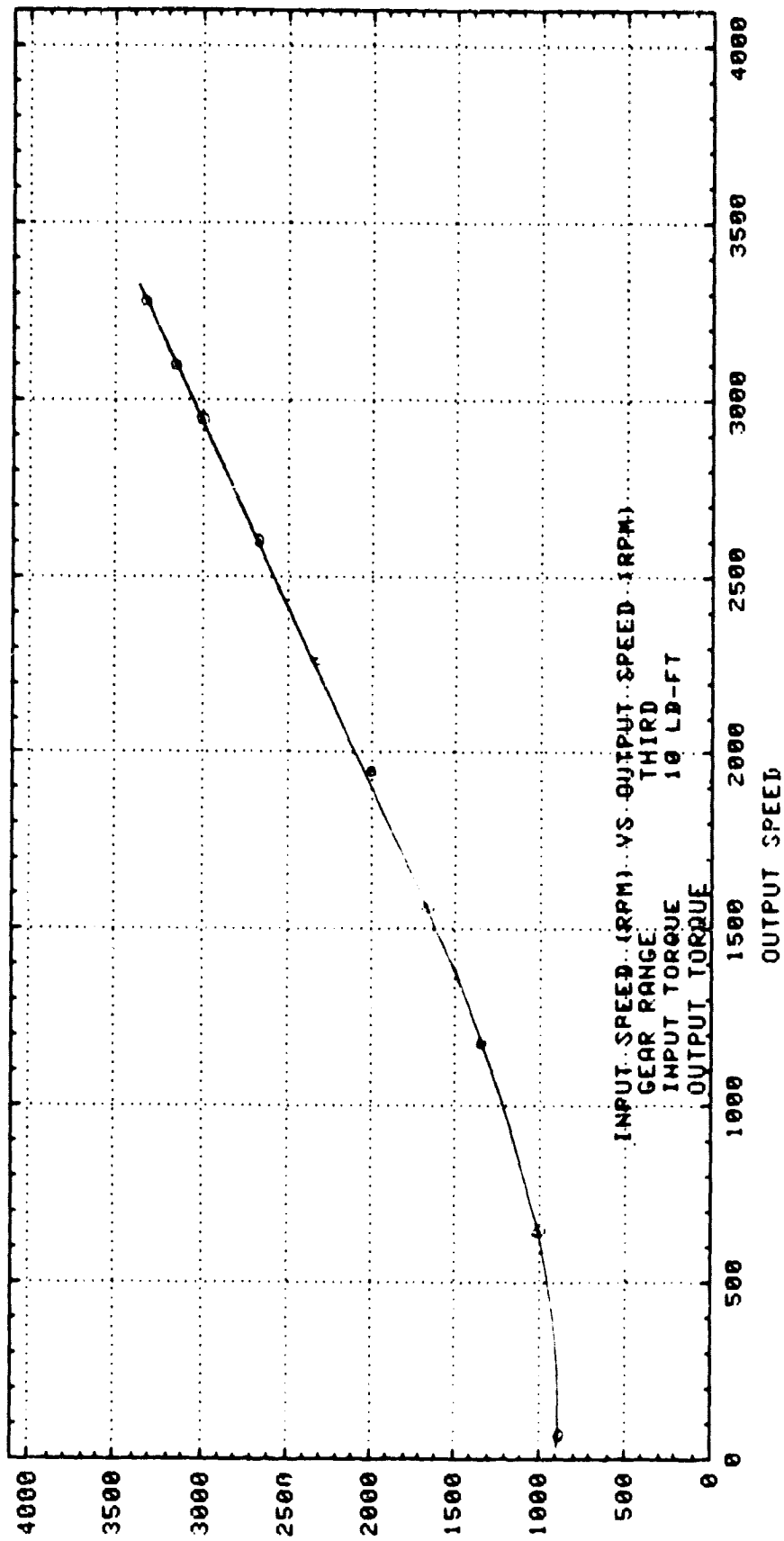

I N P U T S P E E D

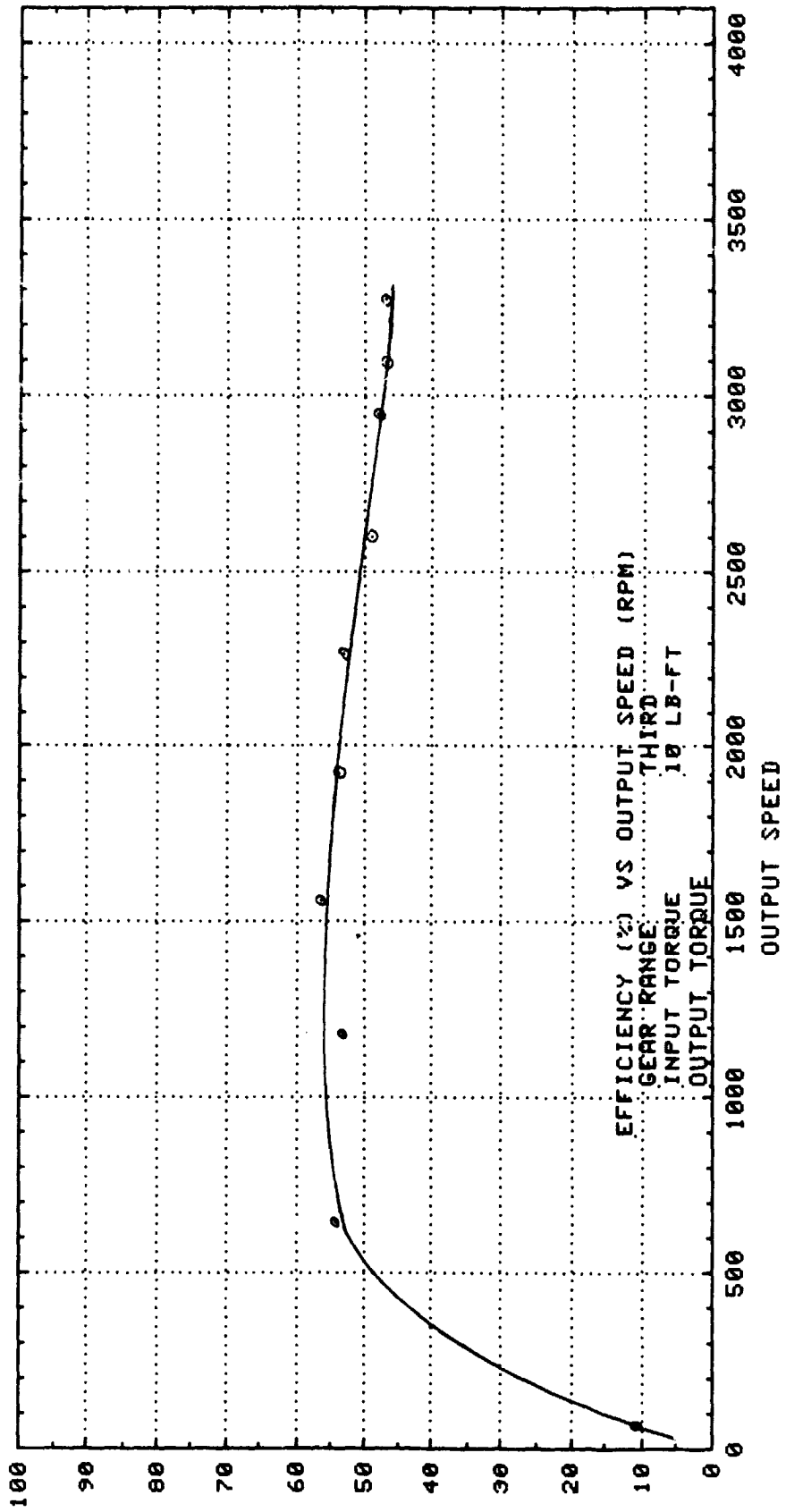

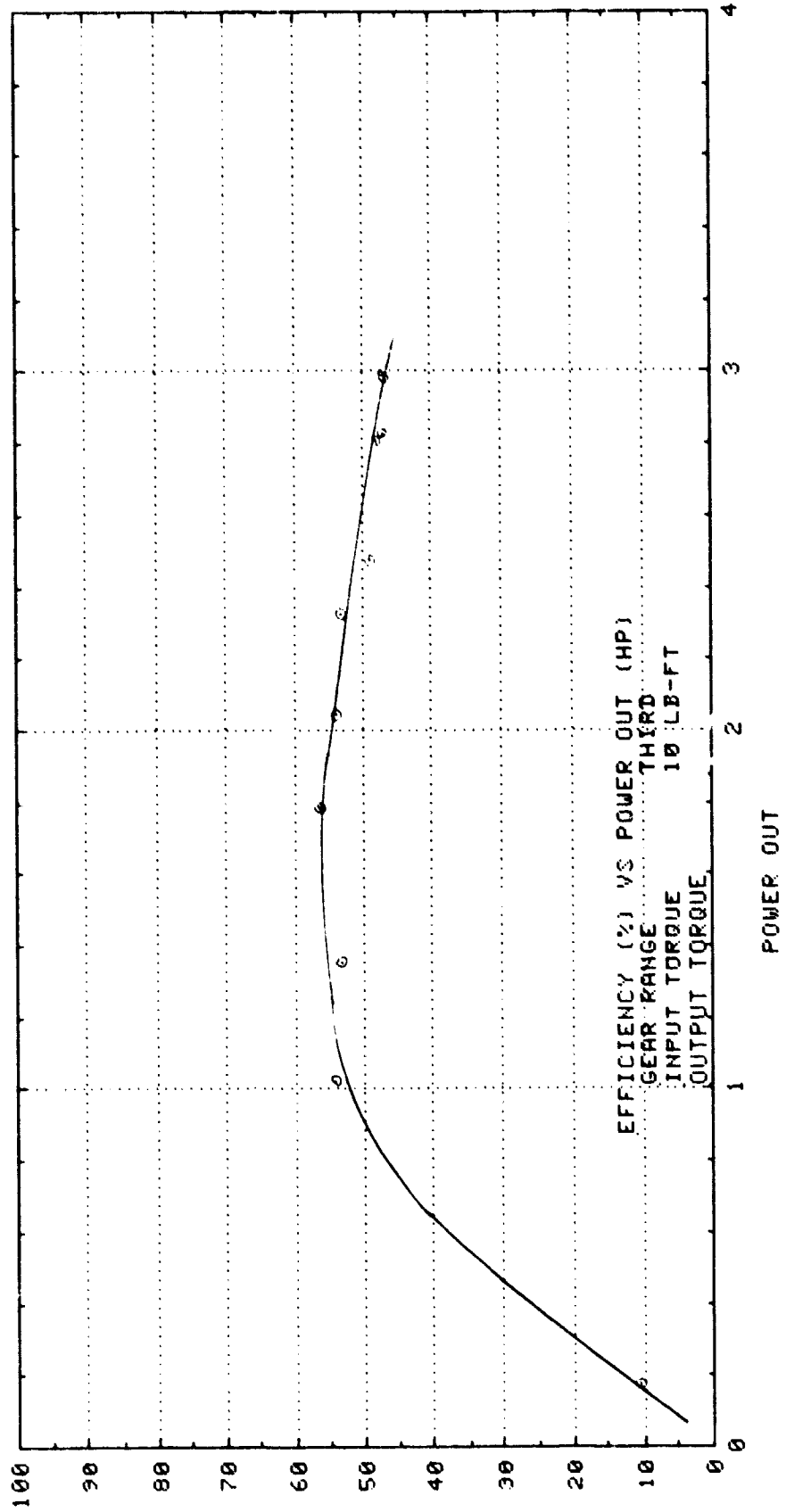

EFFICIENCY

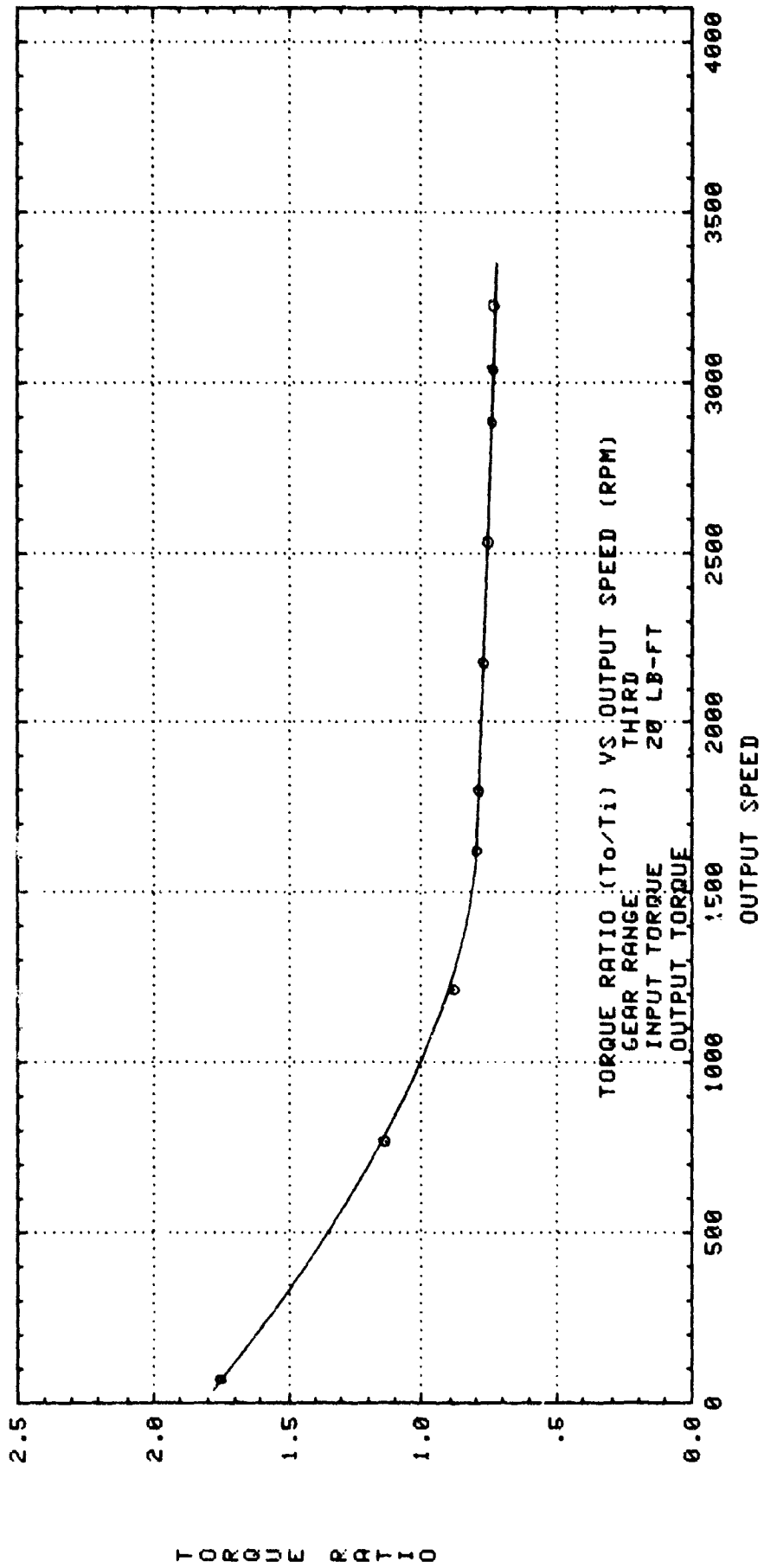

TORQUE RATIO

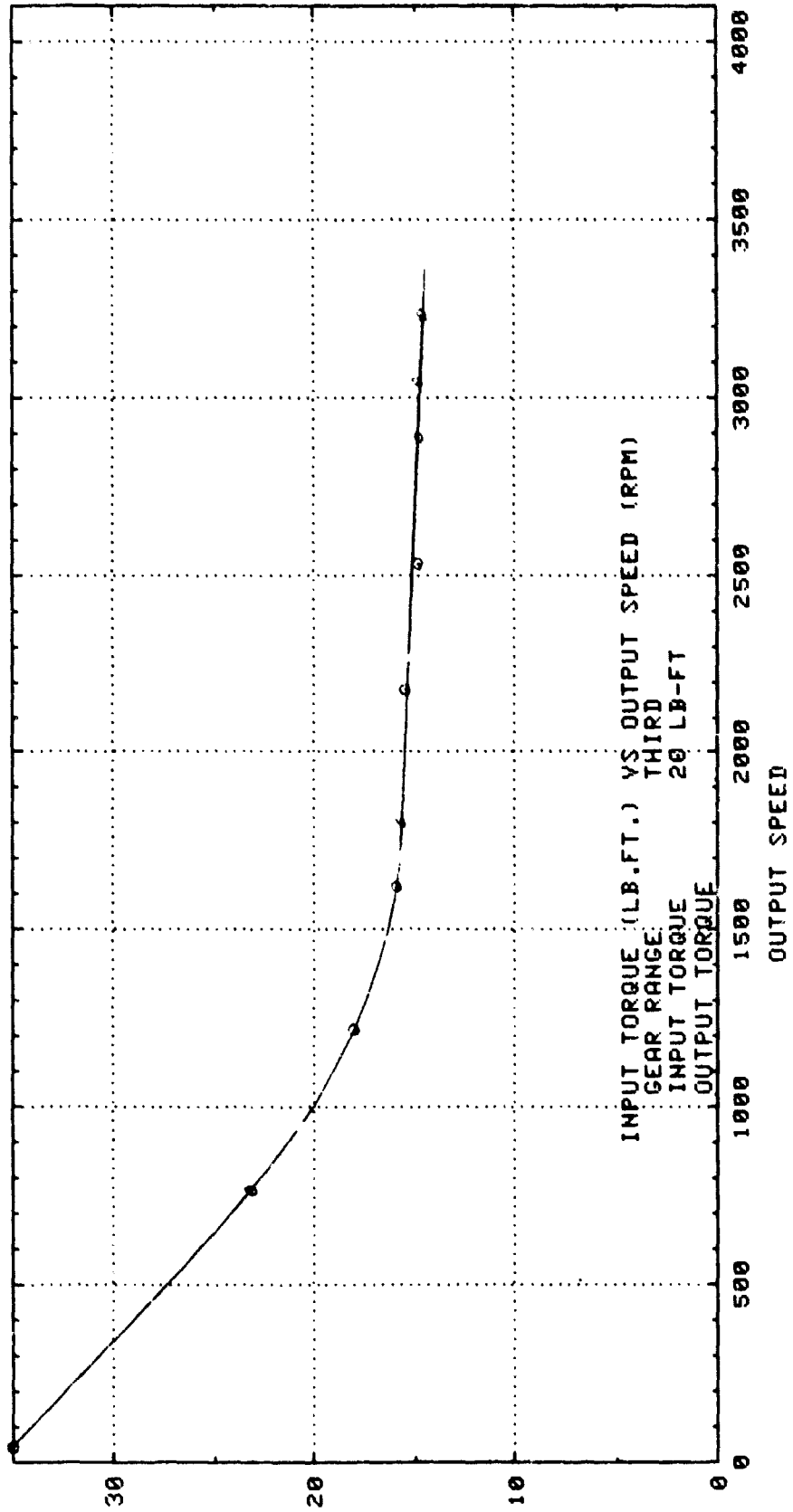

OUTPUT TORQUE

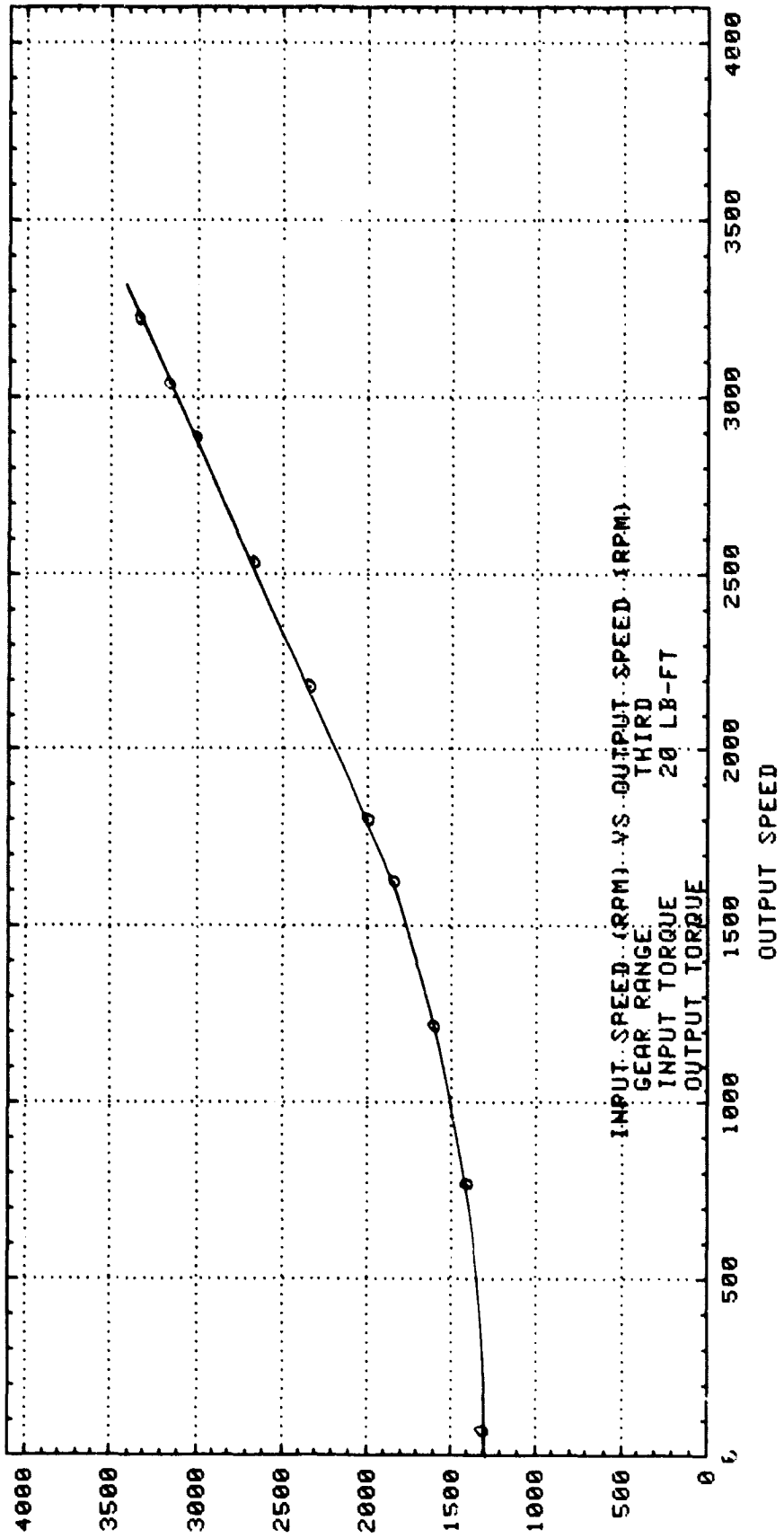



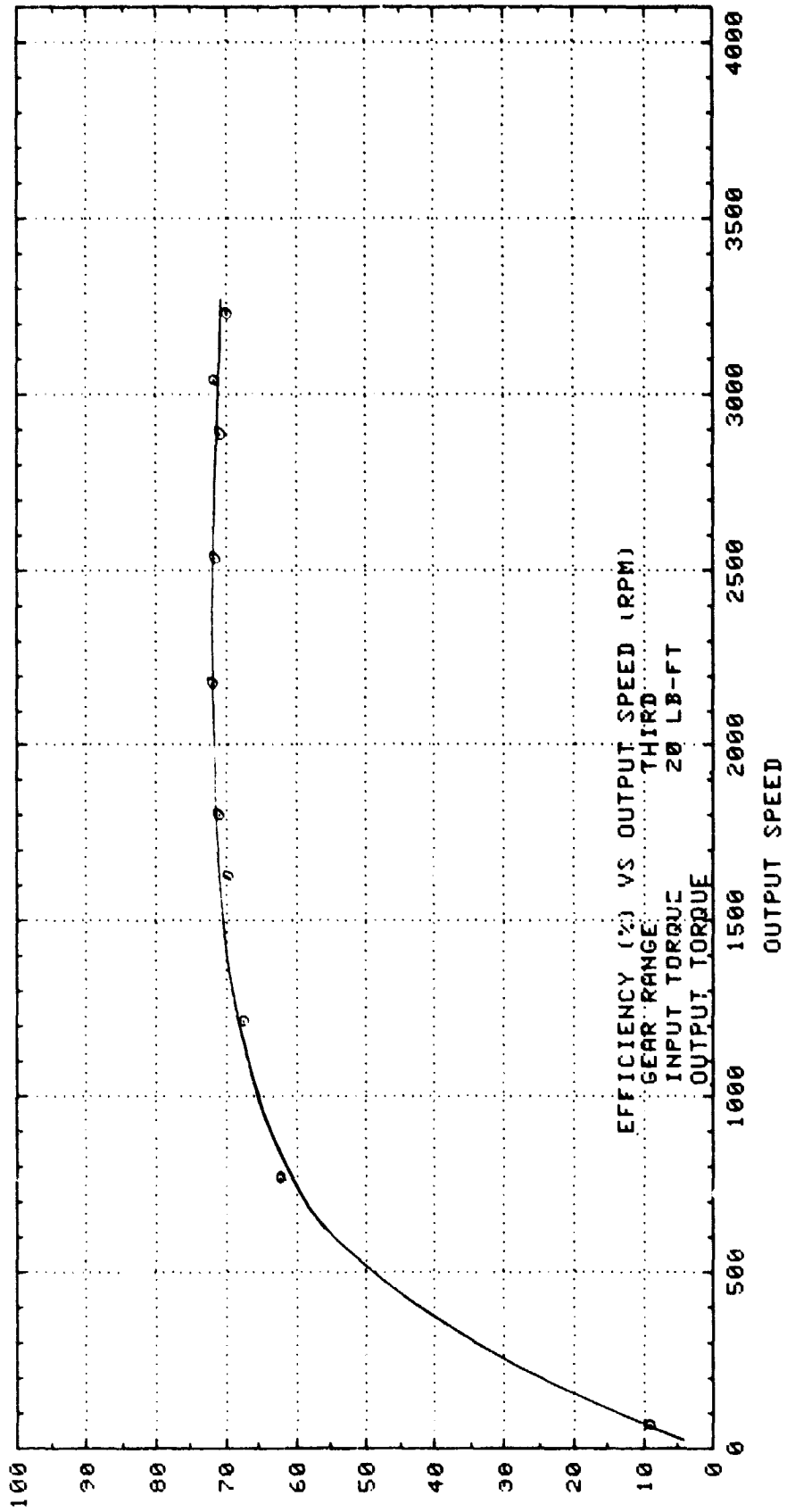

EFFICIENCY

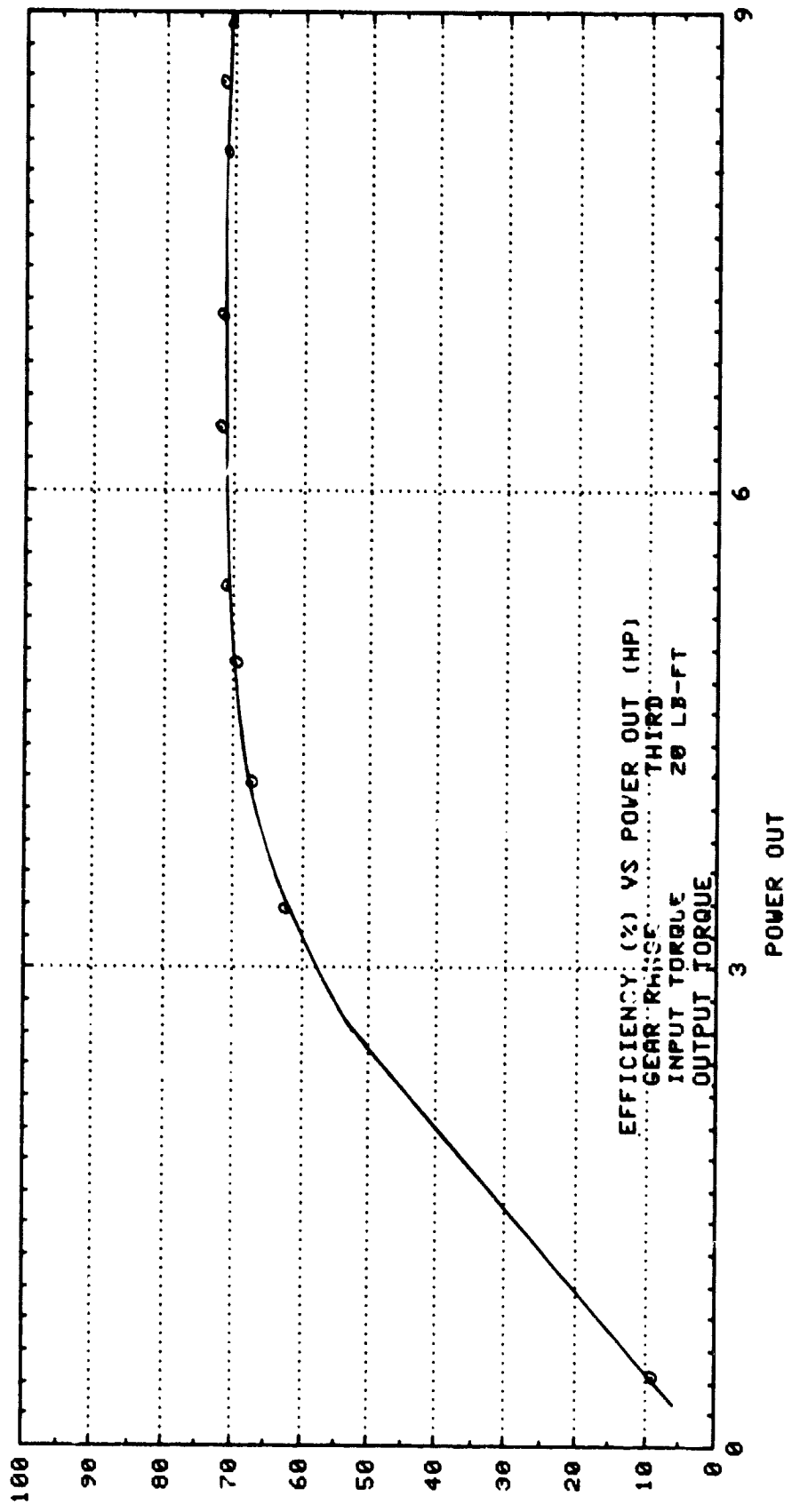

EFFICIENCY

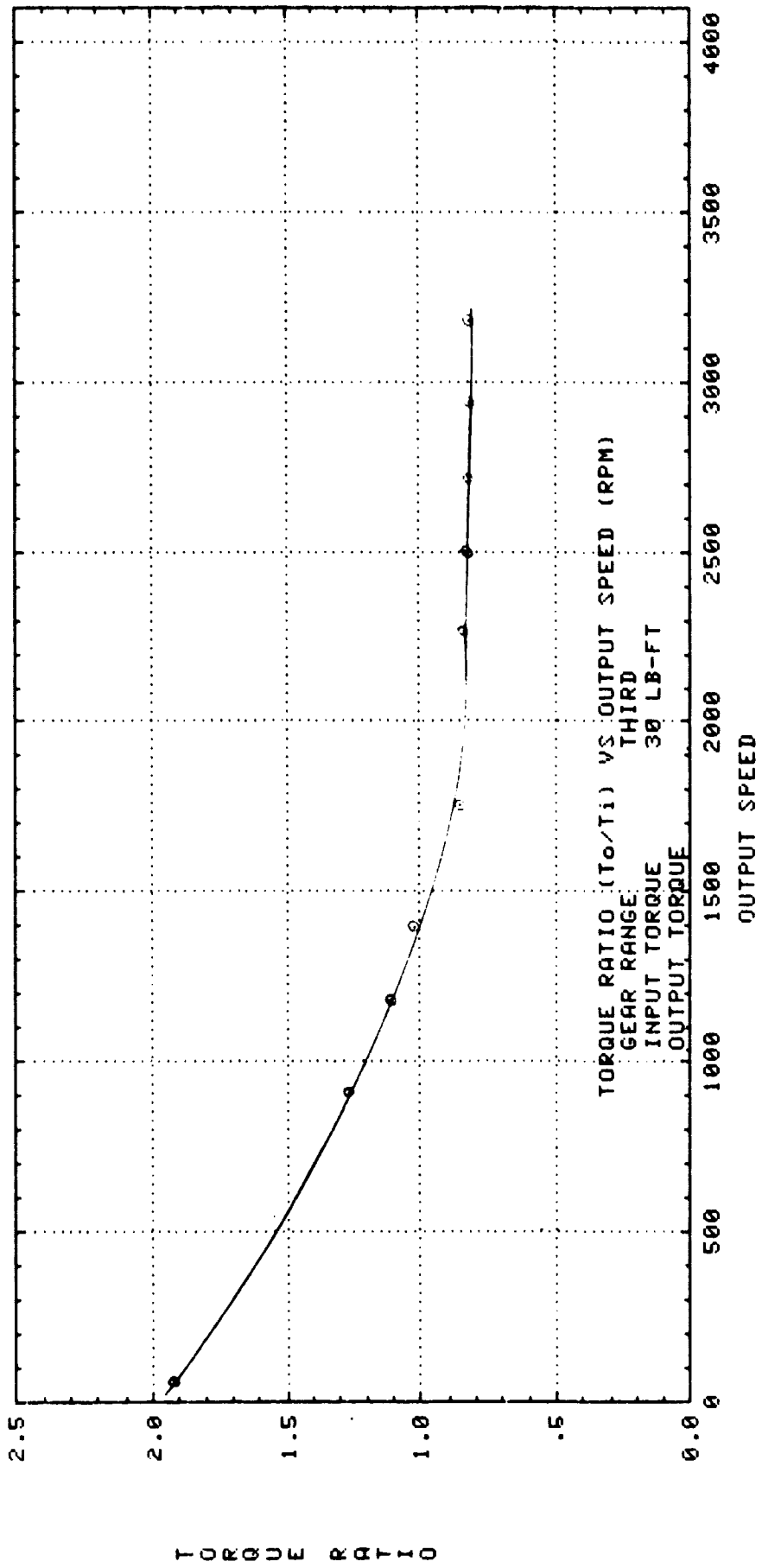

OUTPUT TORQUE

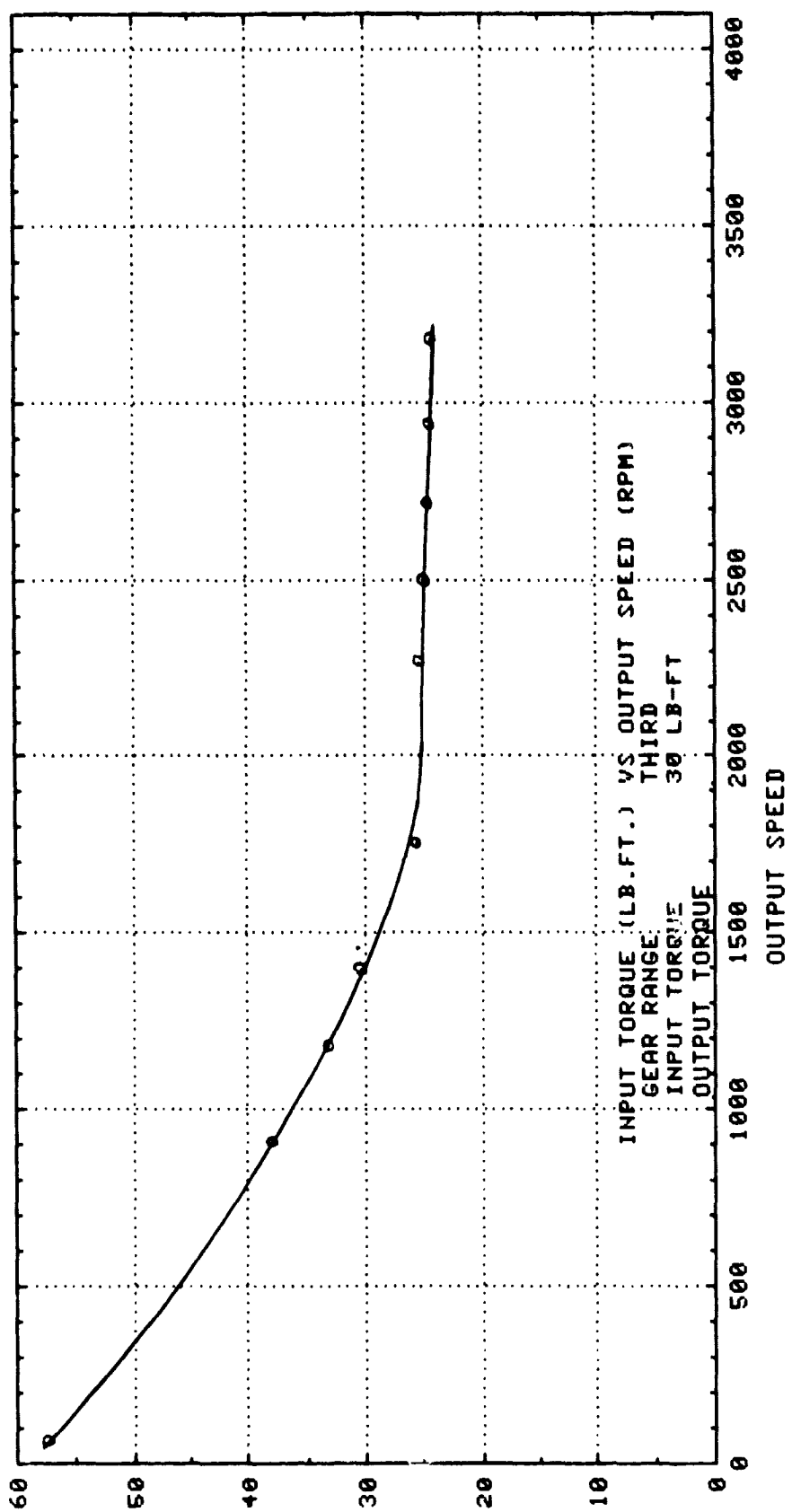

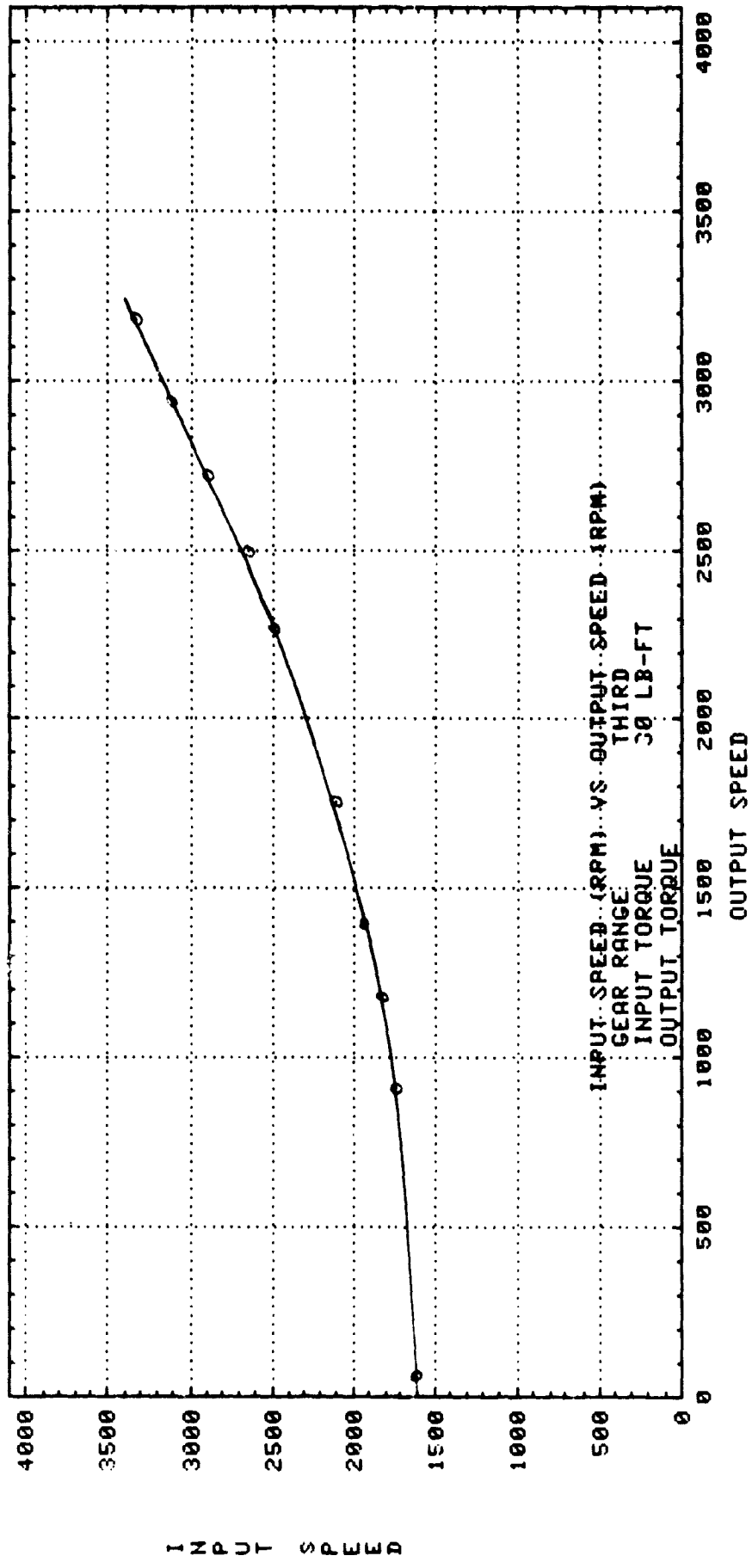

INPUT SPEED

EFFICIENCY

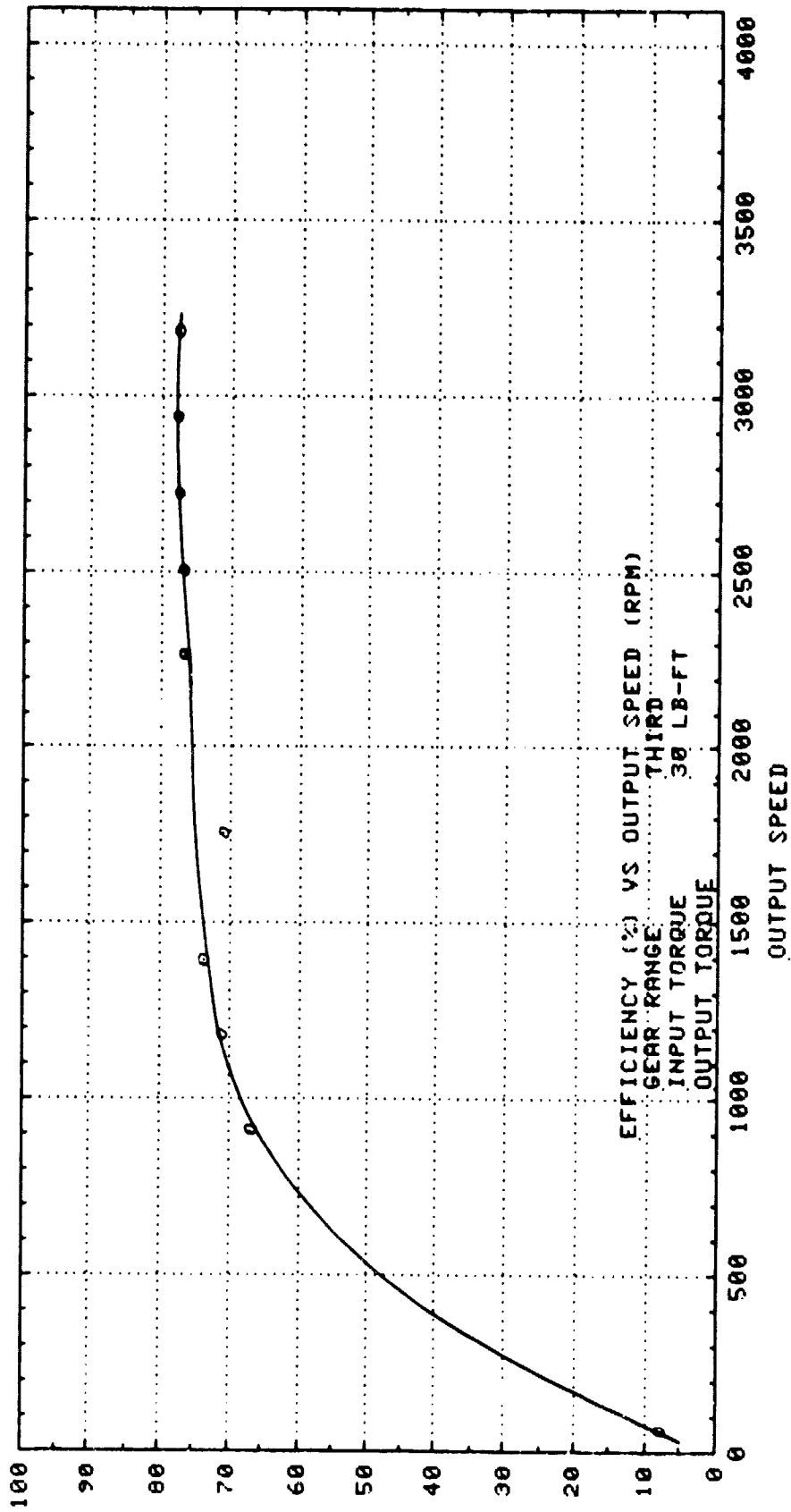

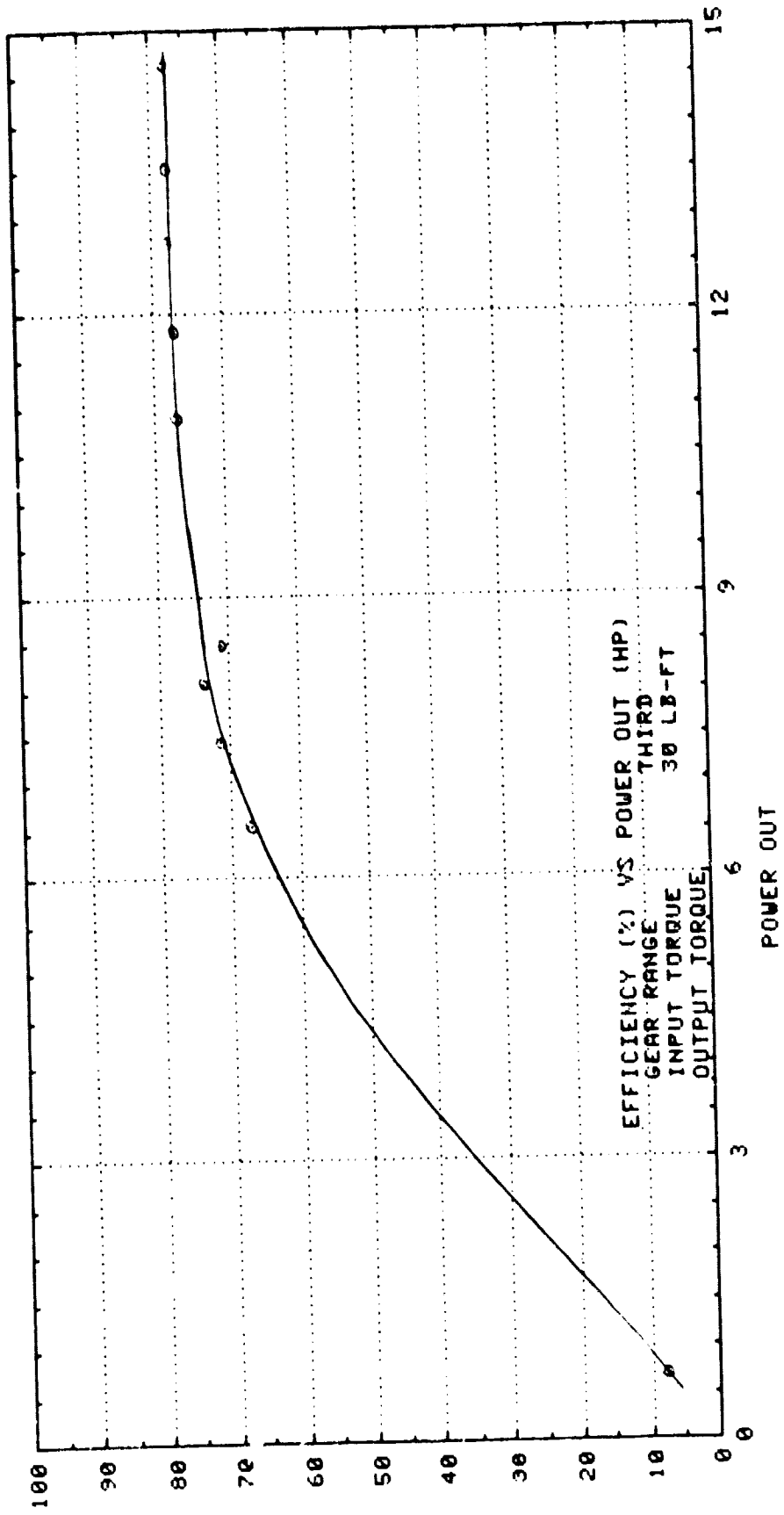

EFFICIENCY

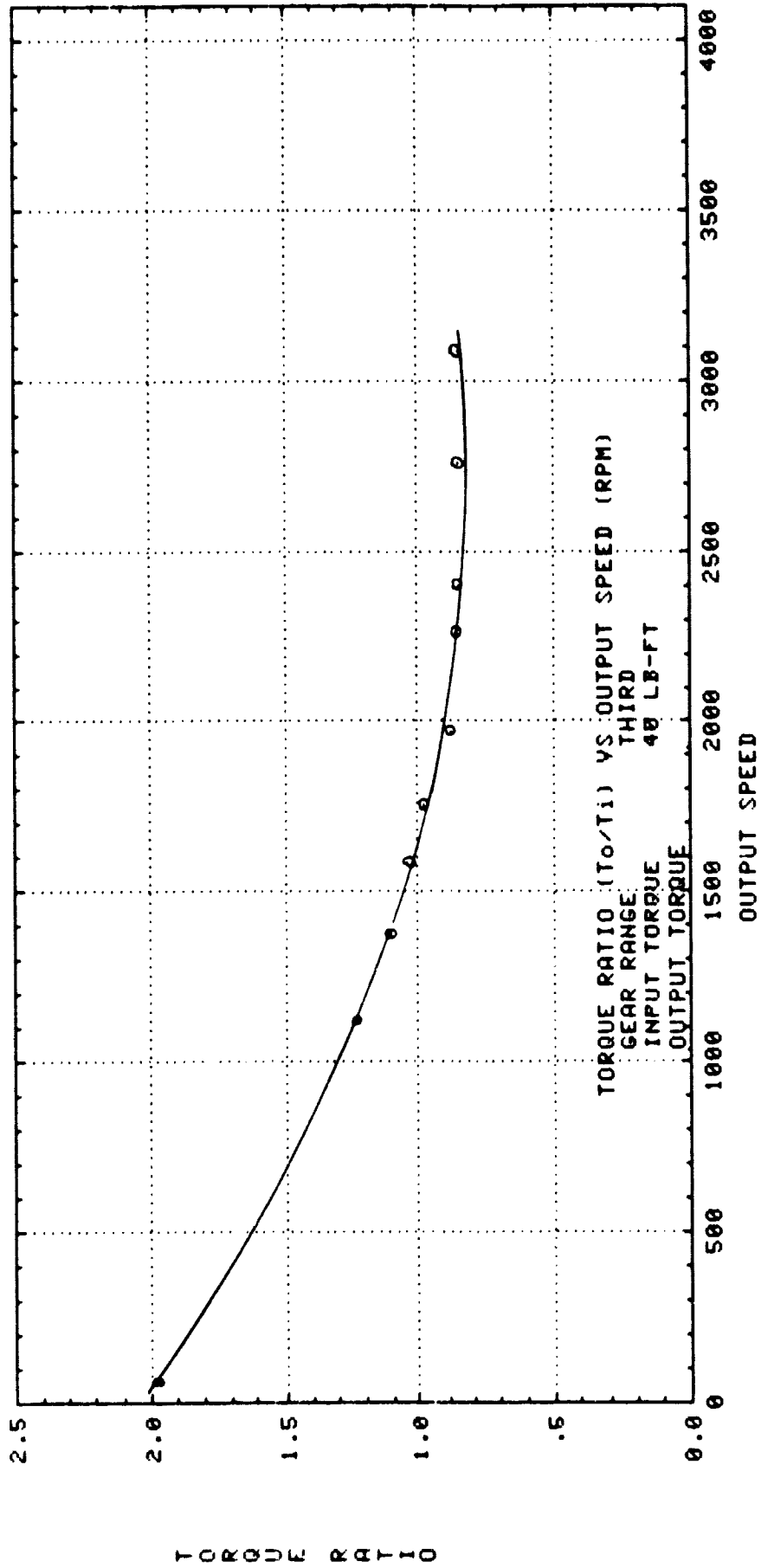



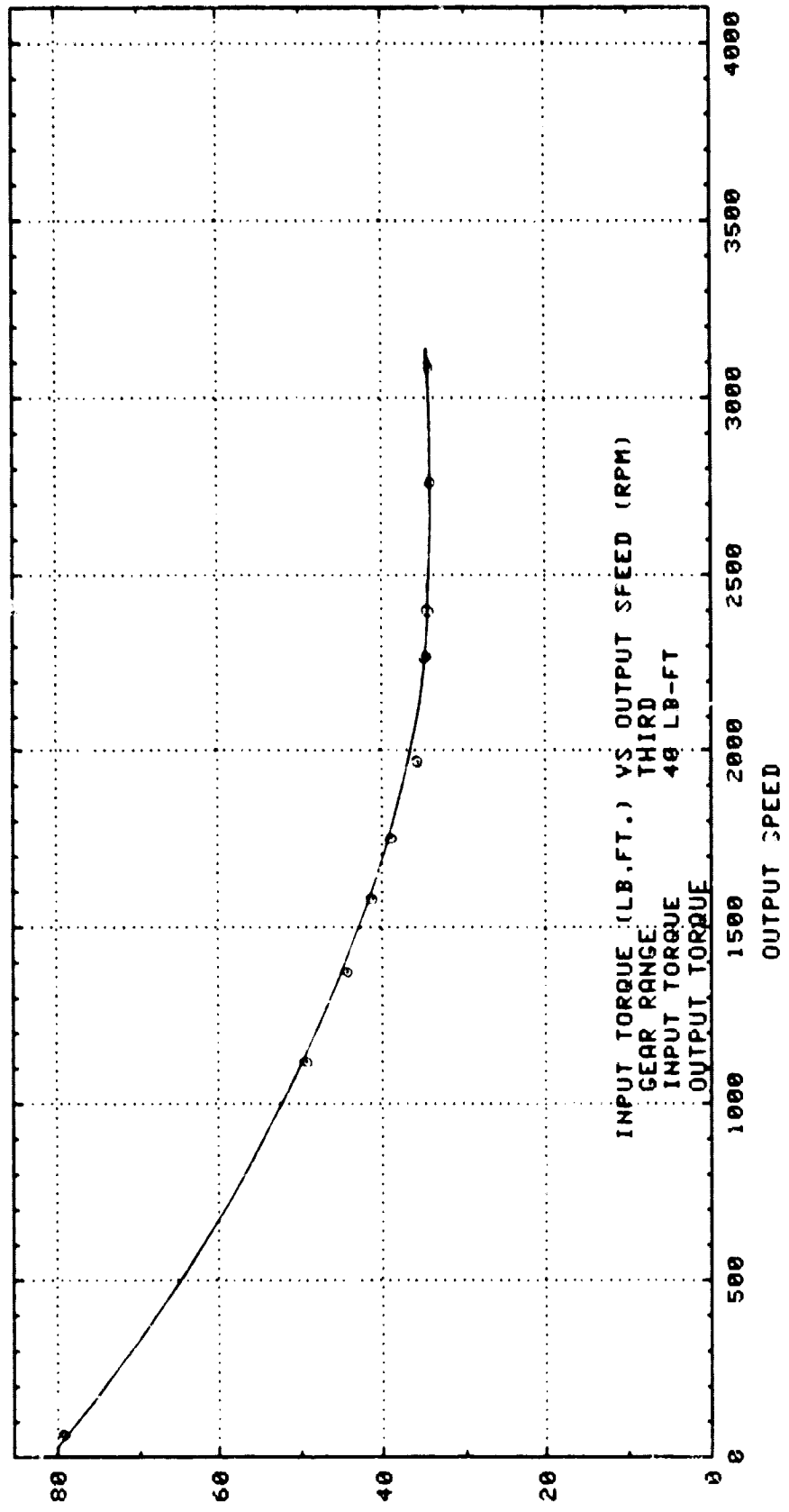

OUTPUT TORQUE

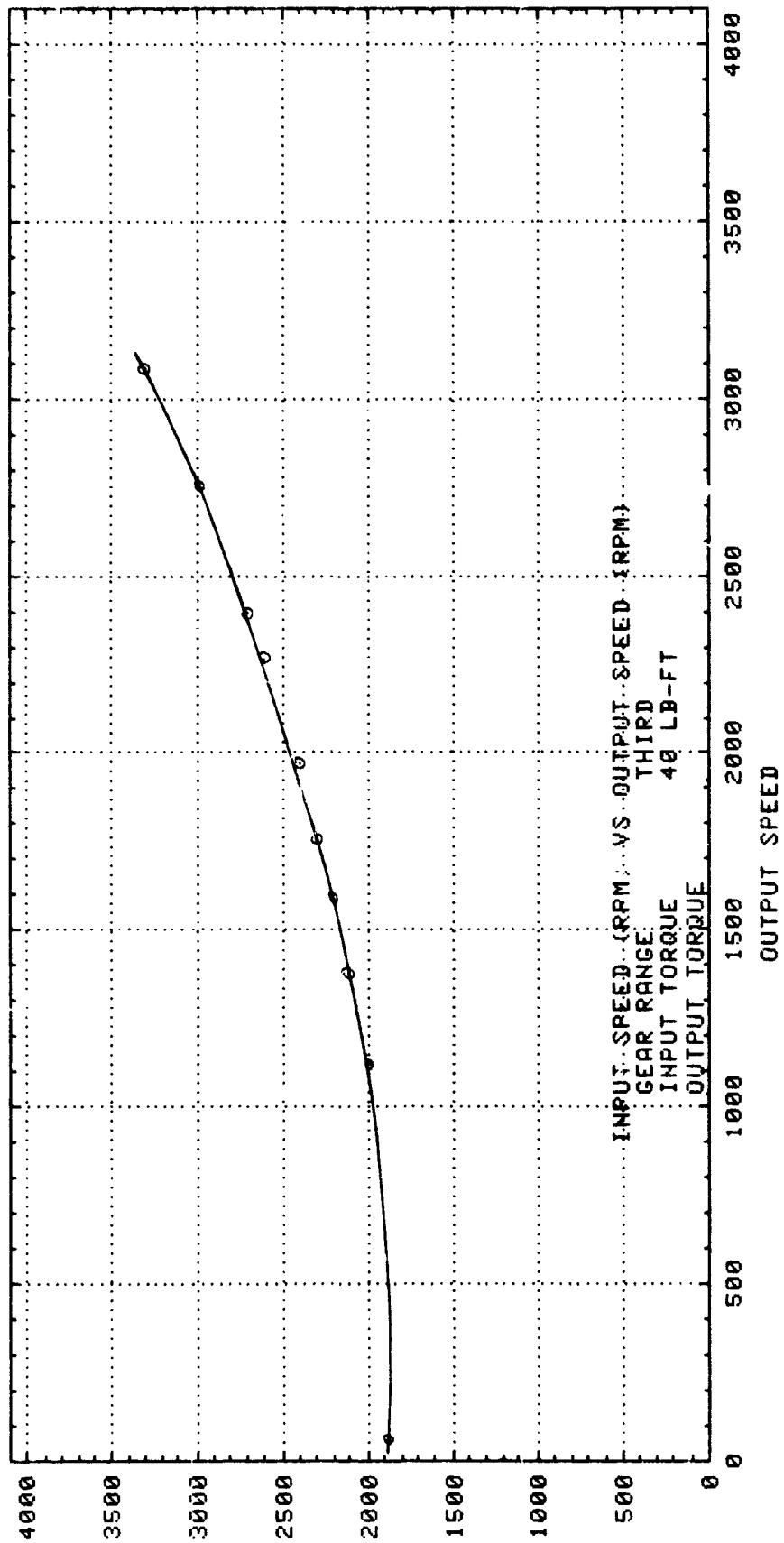

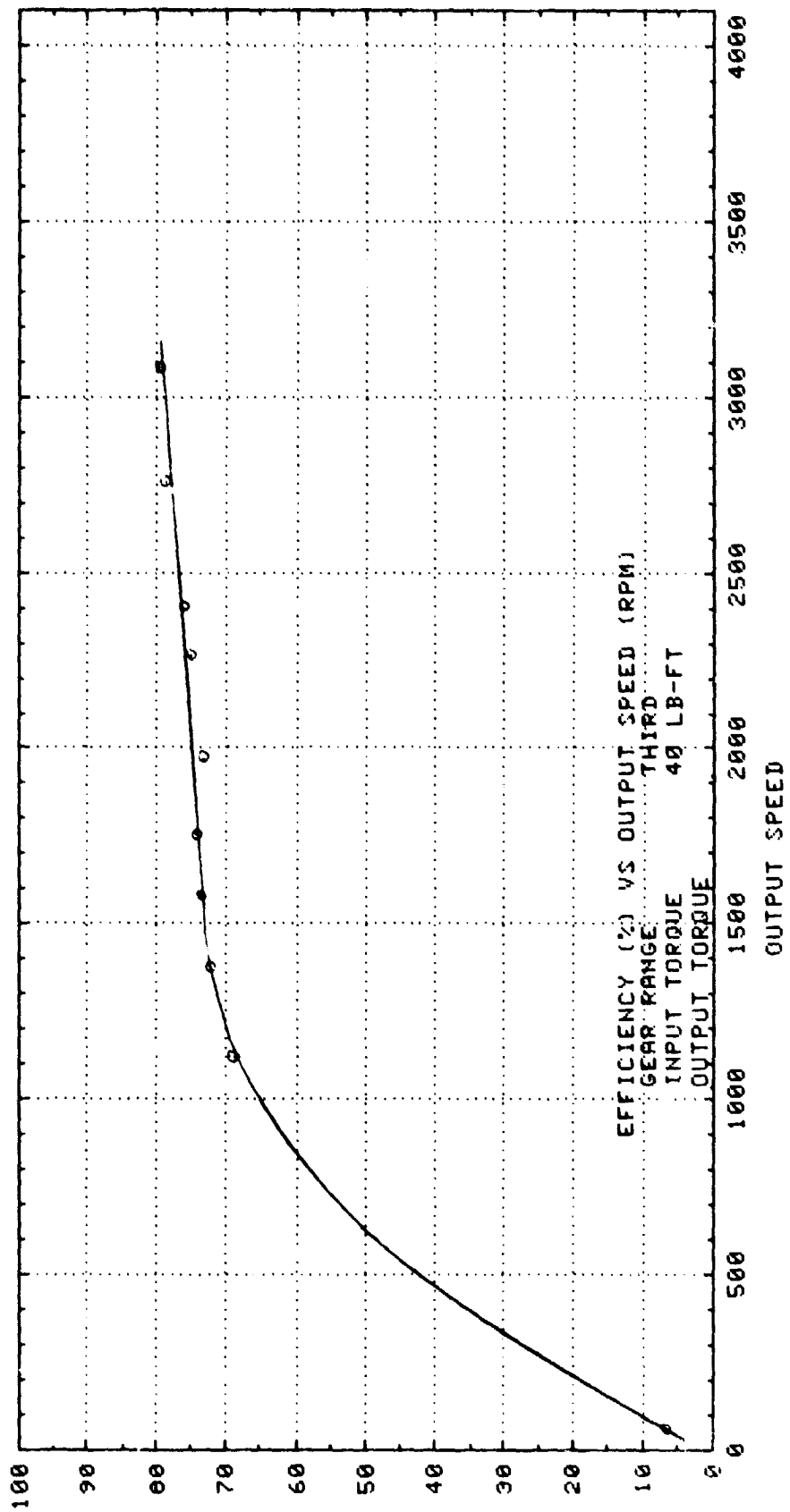

EFFICIENCY

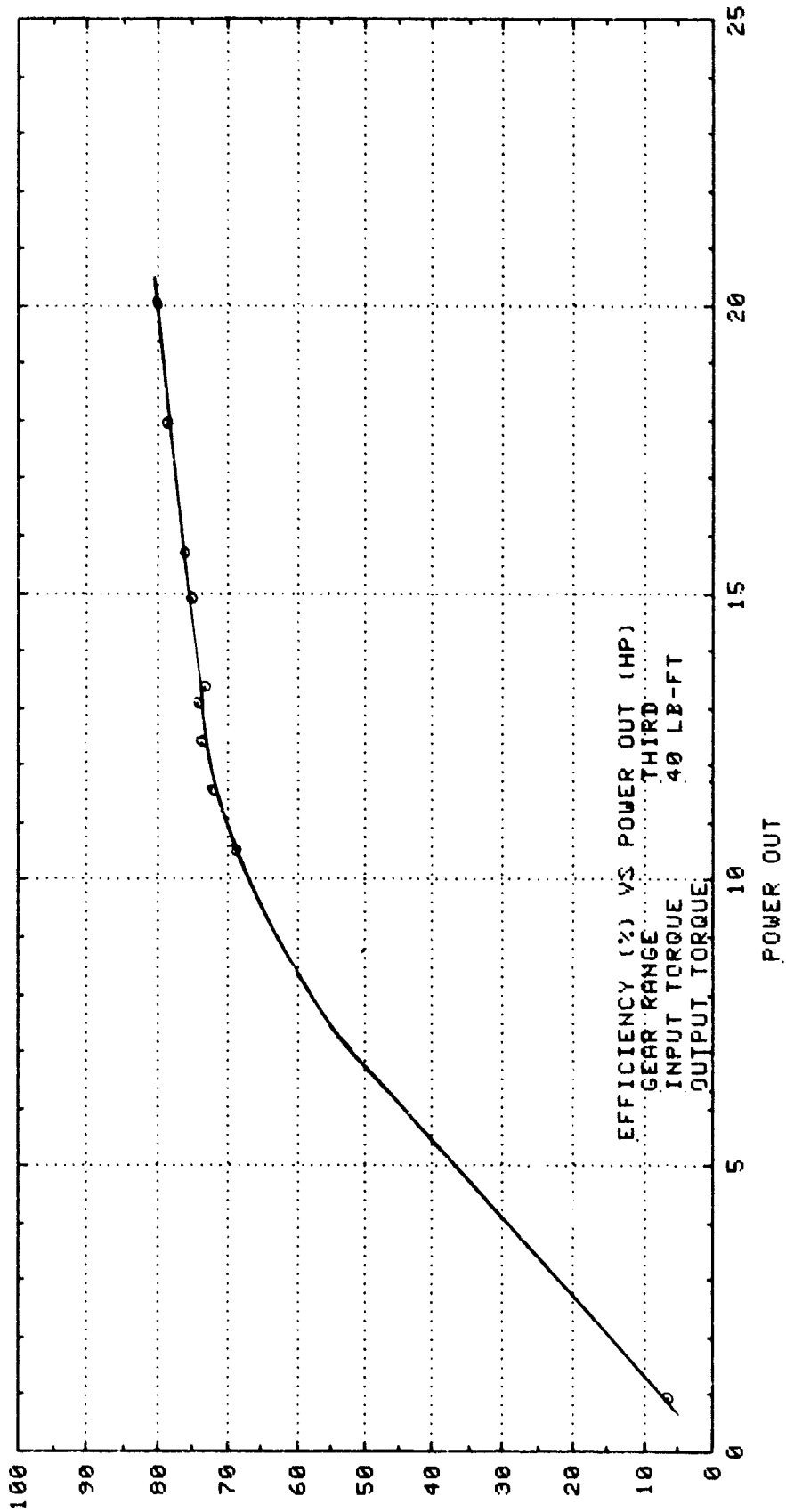

EFFICIENCY

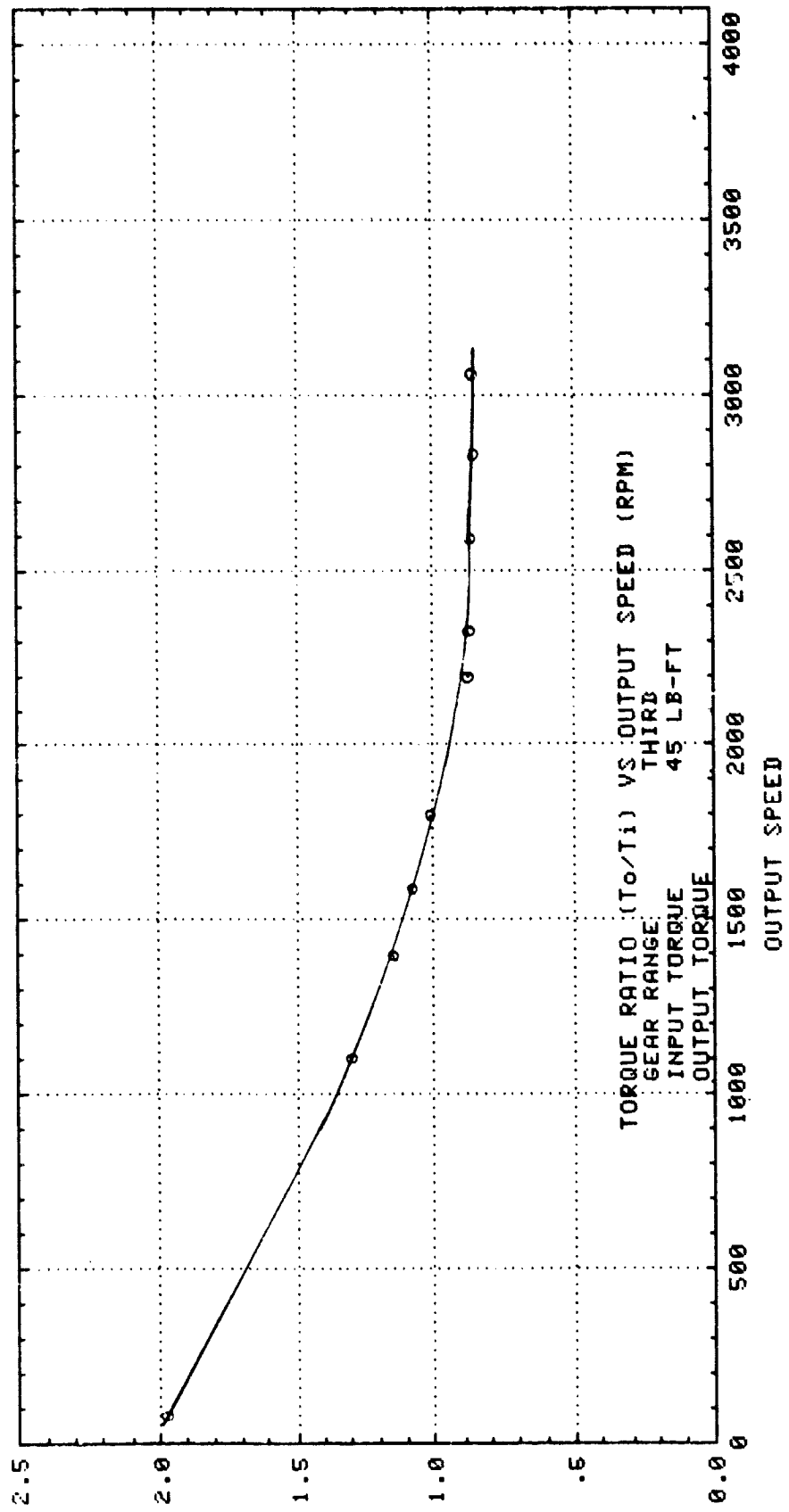

TORQUE RATIO

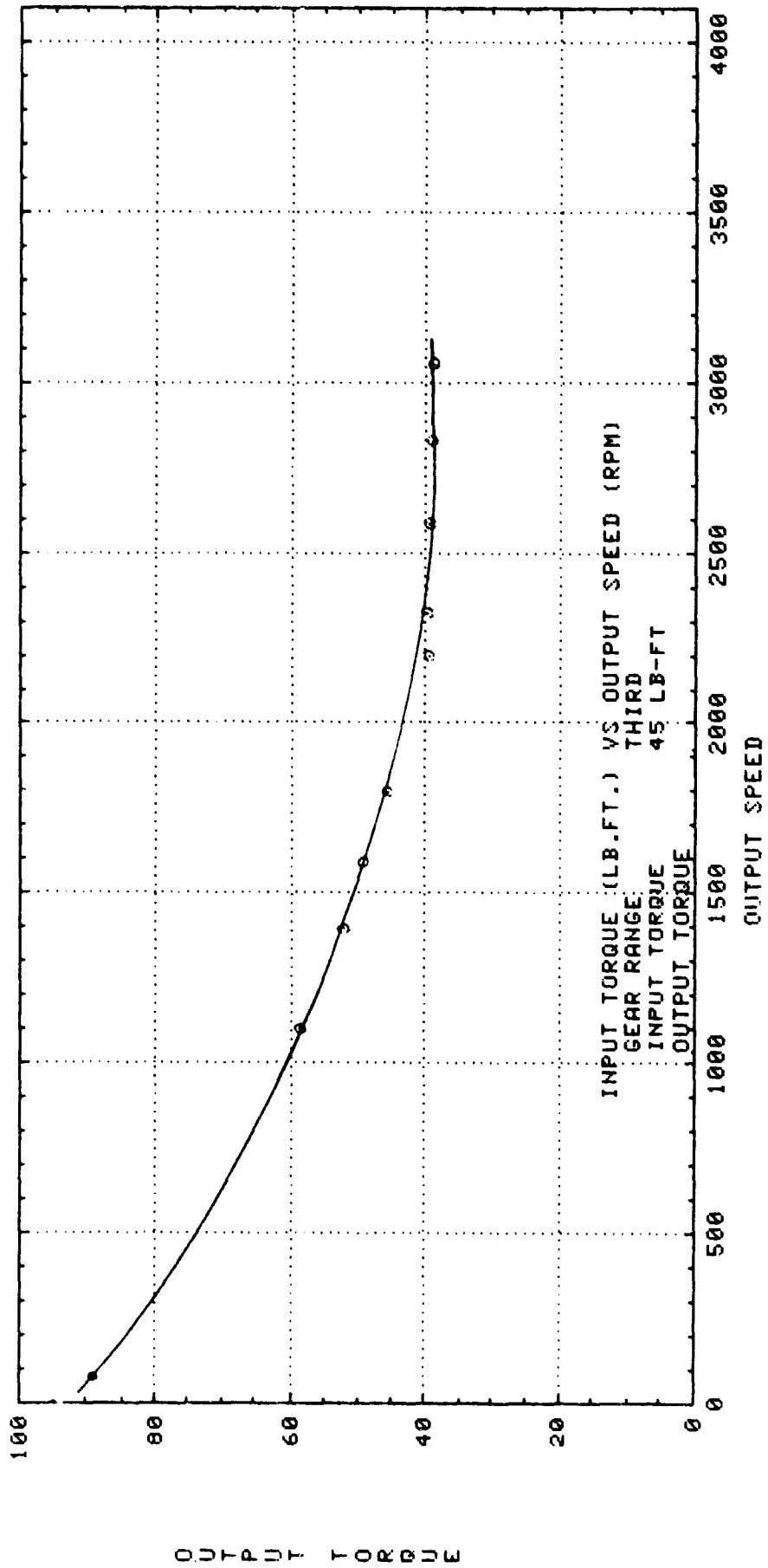

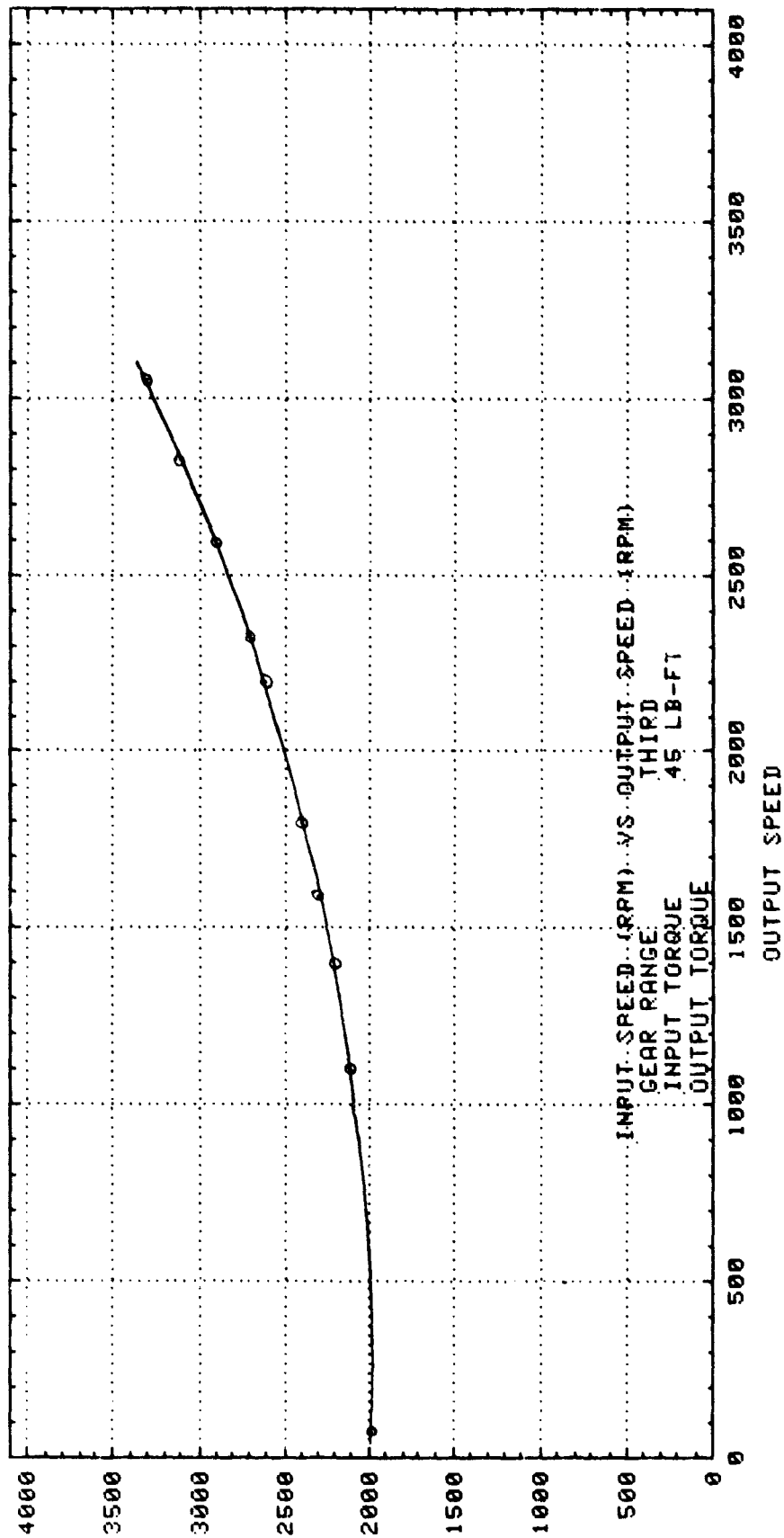

INPUT SPEED

EFFICIENCY

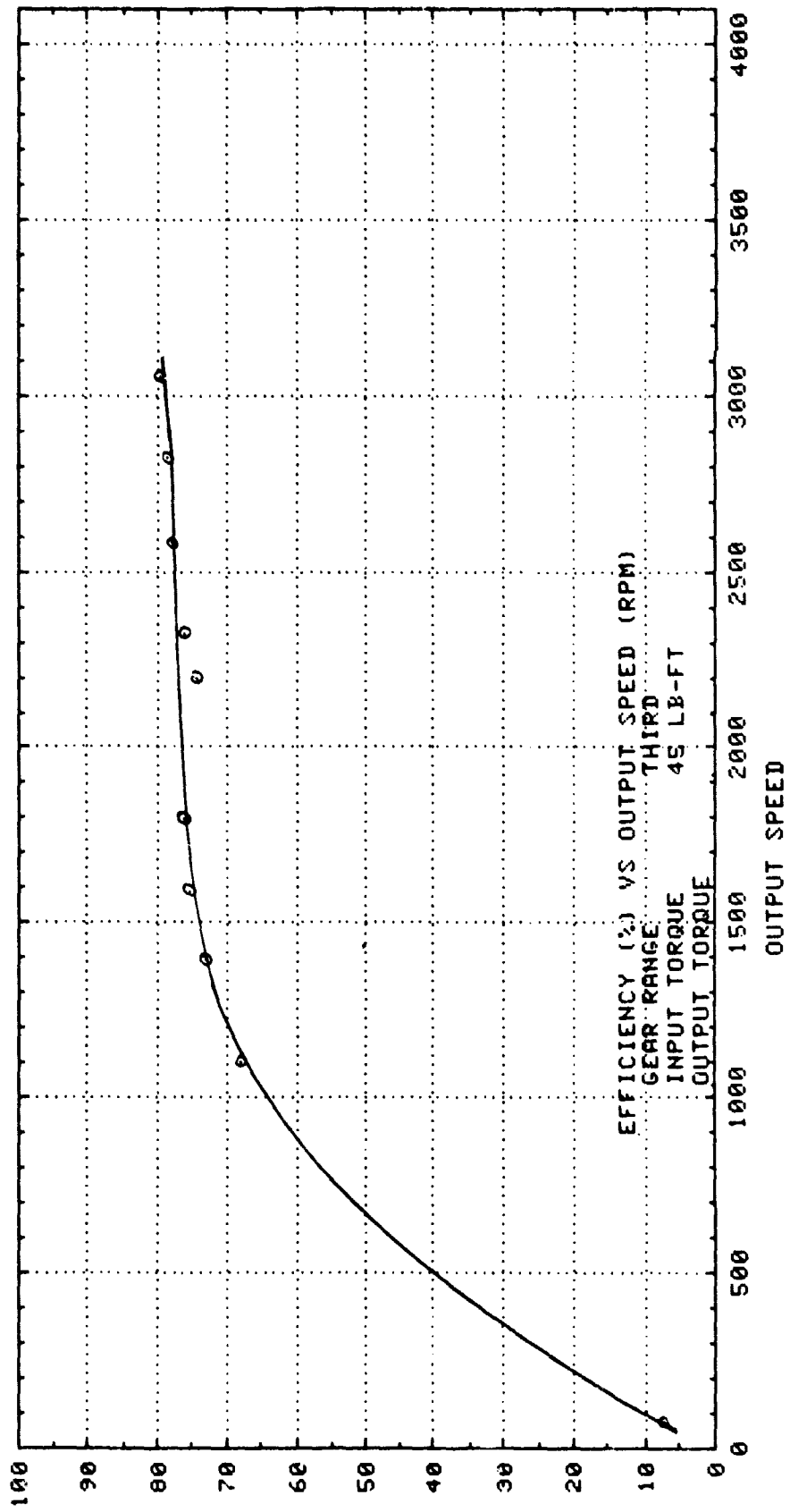



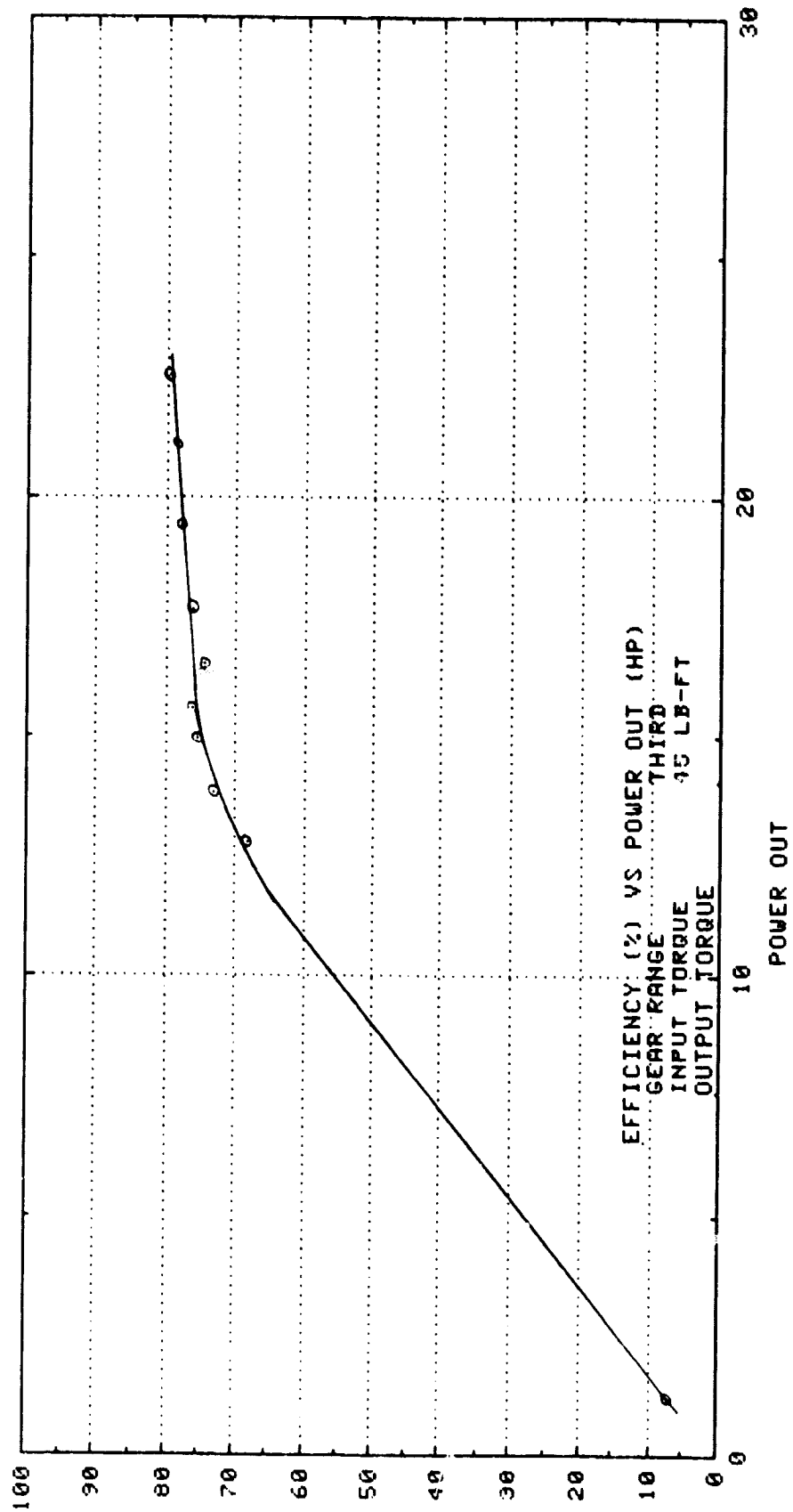

EFFICIENCY

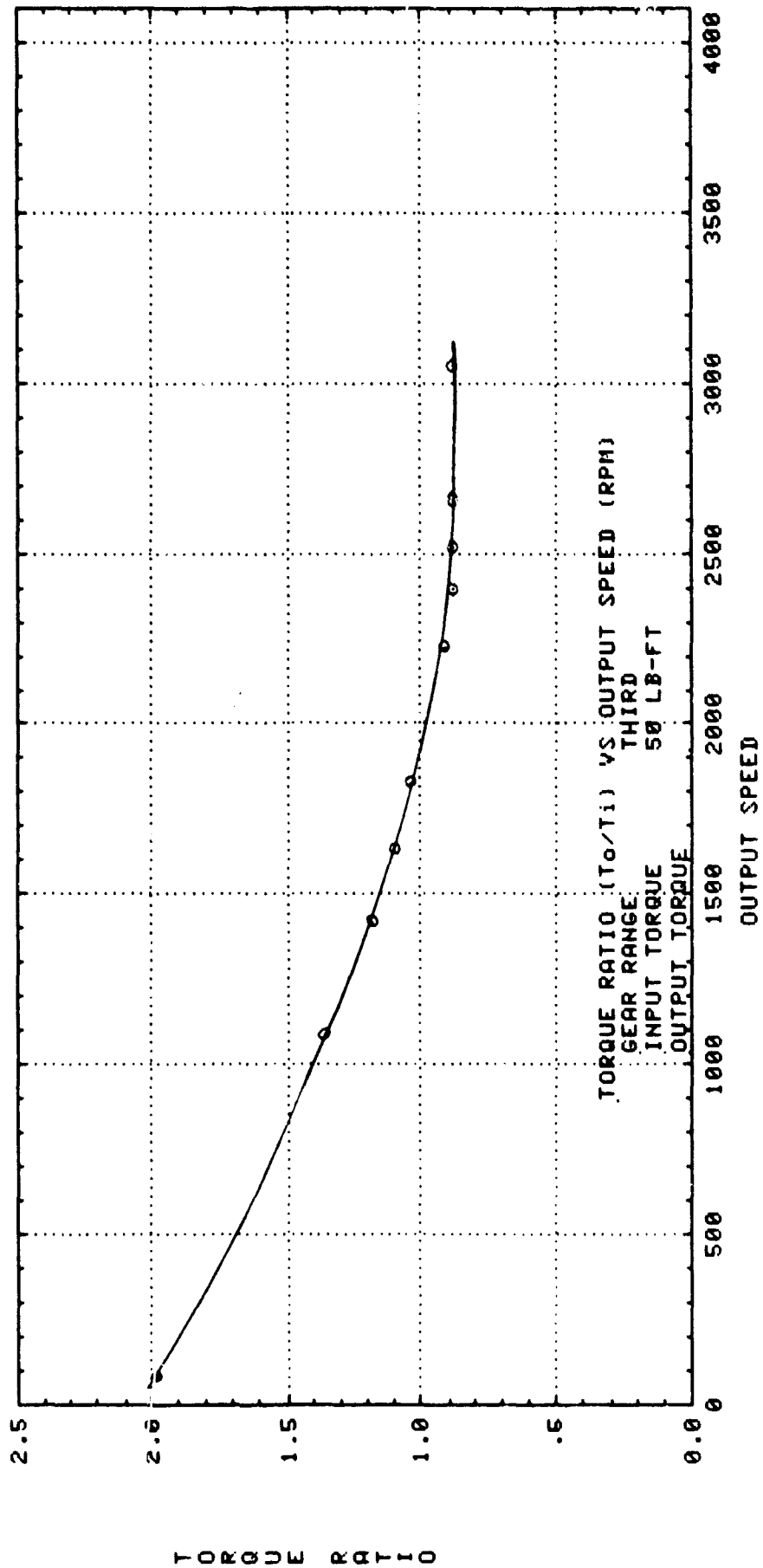

TORQUE RATIO

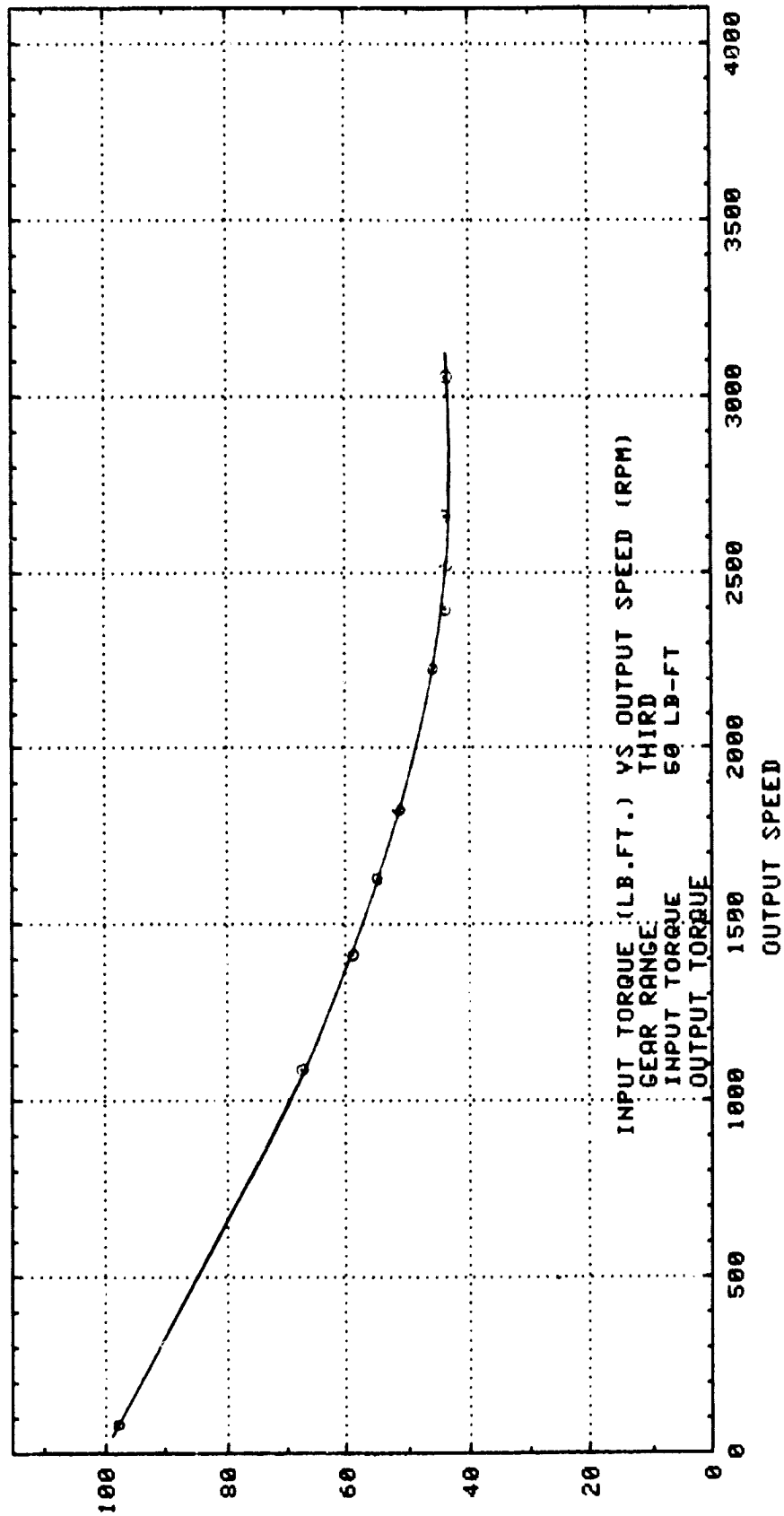

OUTPUT TORQUE

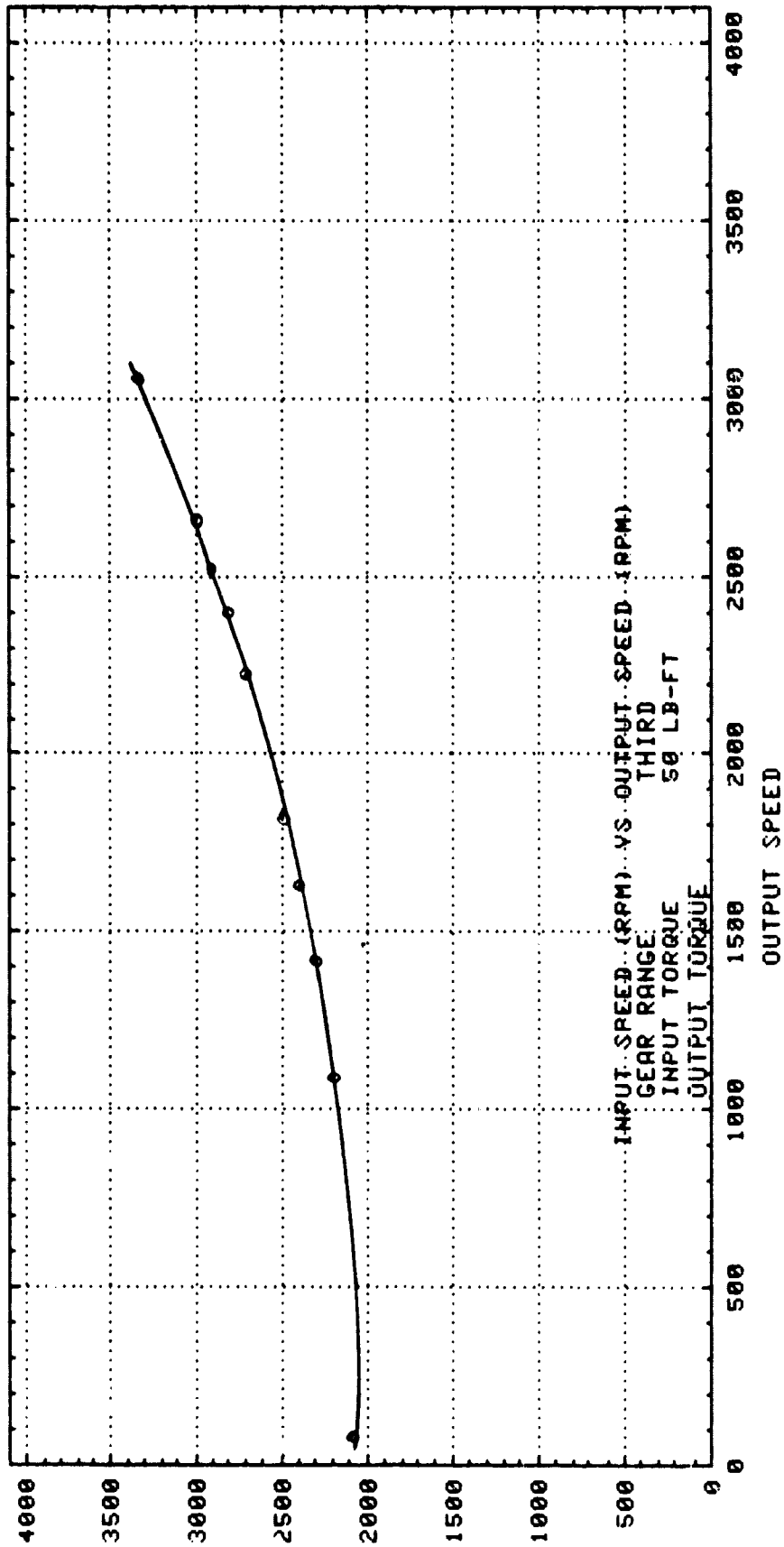

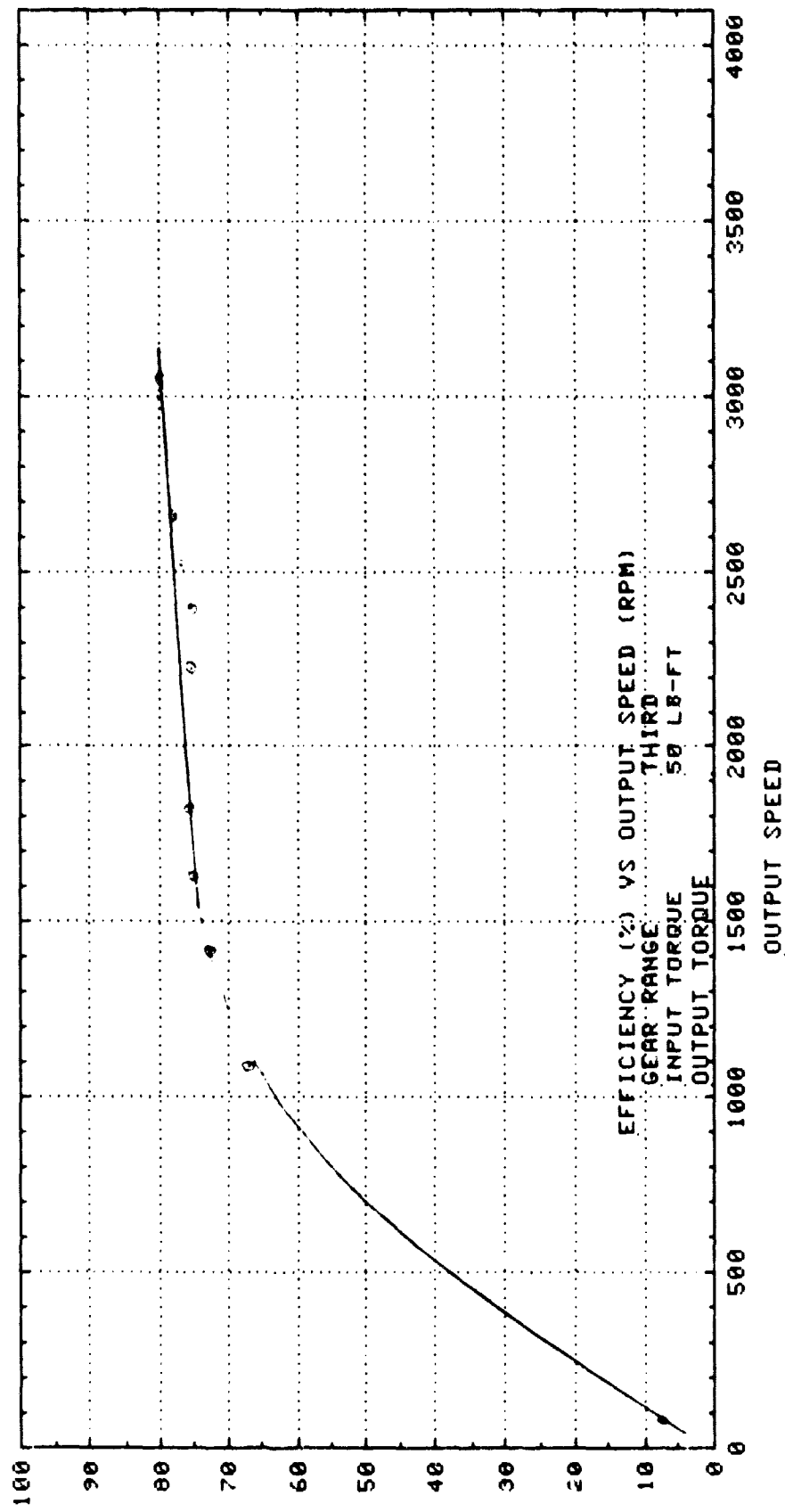

EFFICIENCY

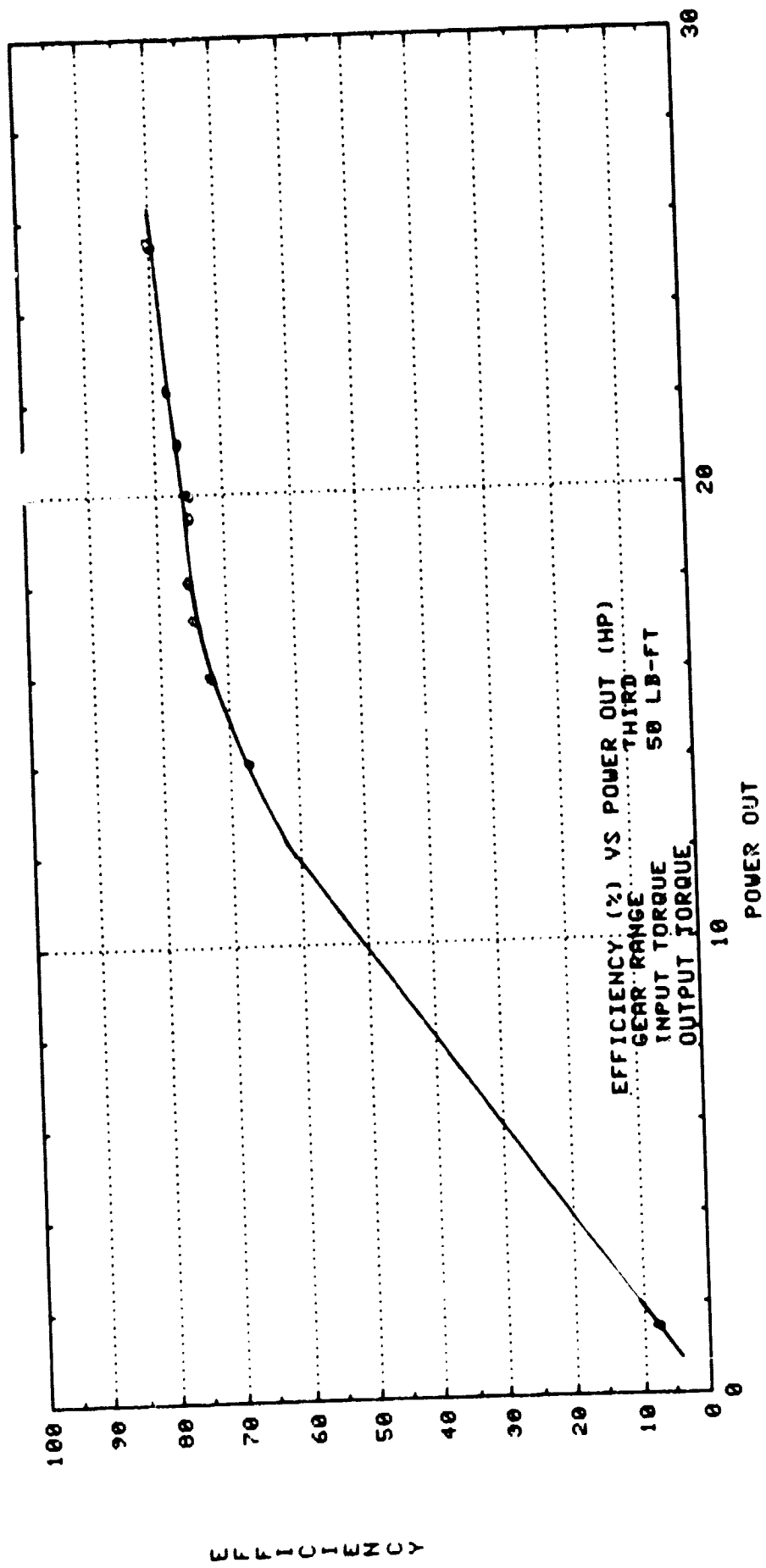

EFFICIENCY

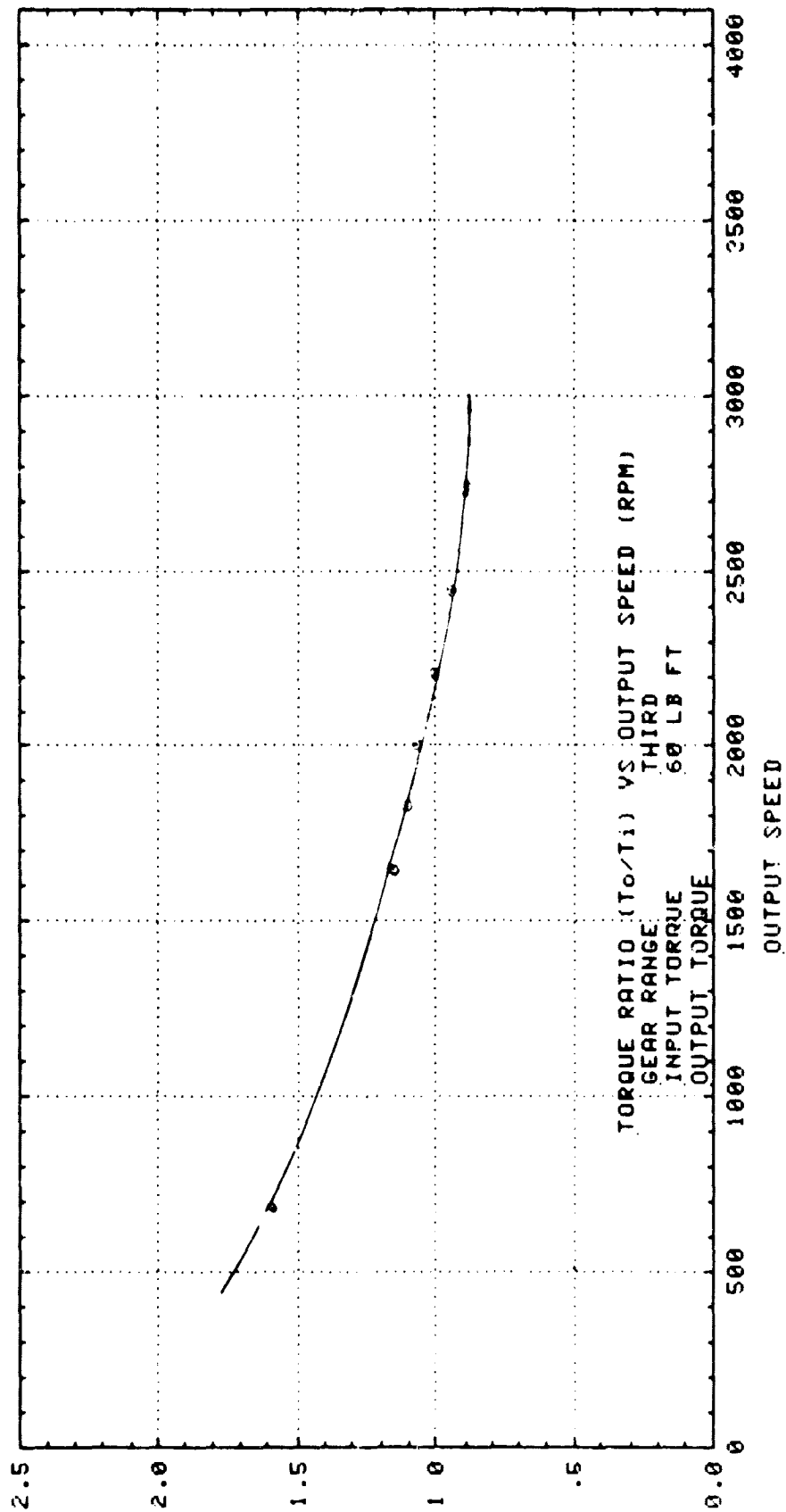

TORQUE RATIO

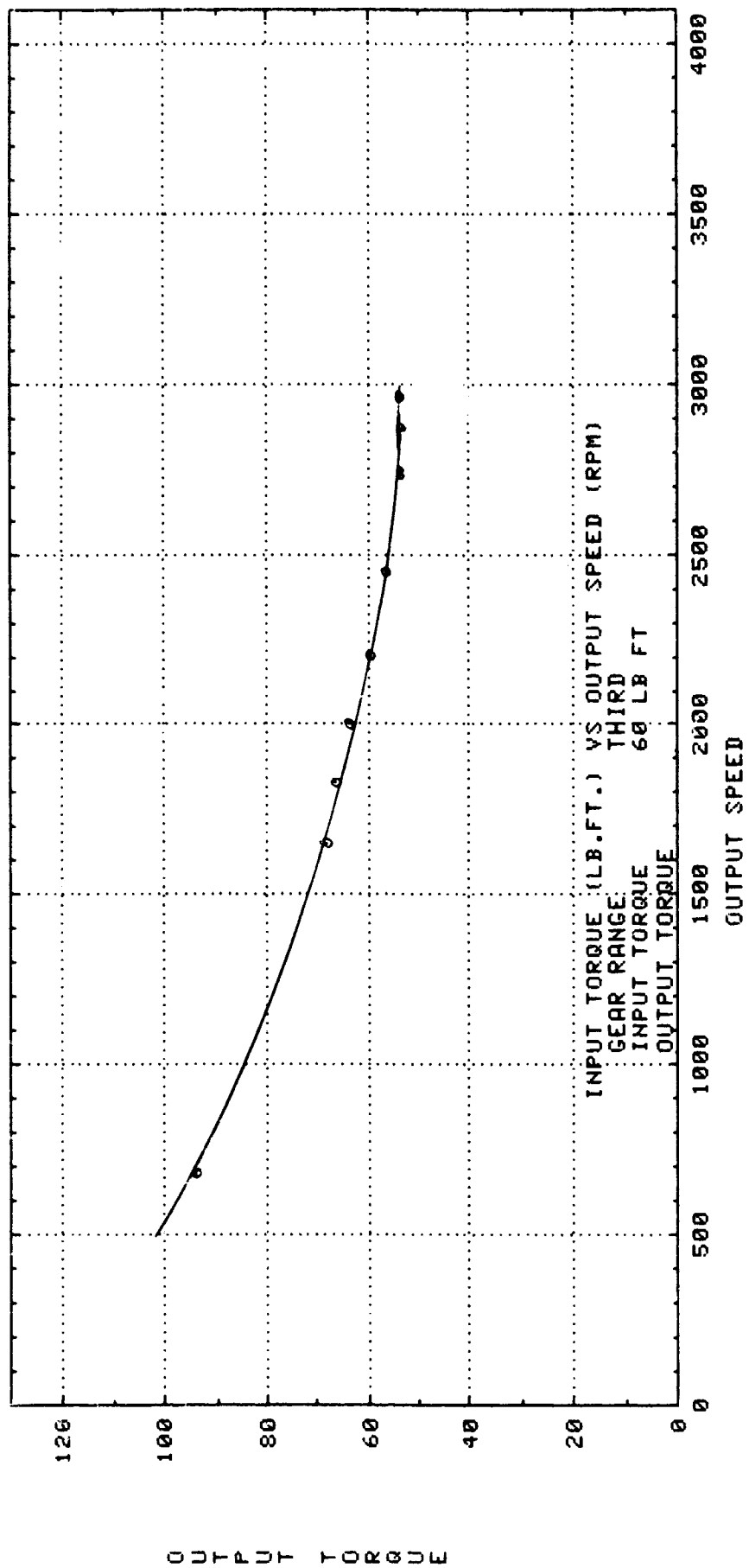



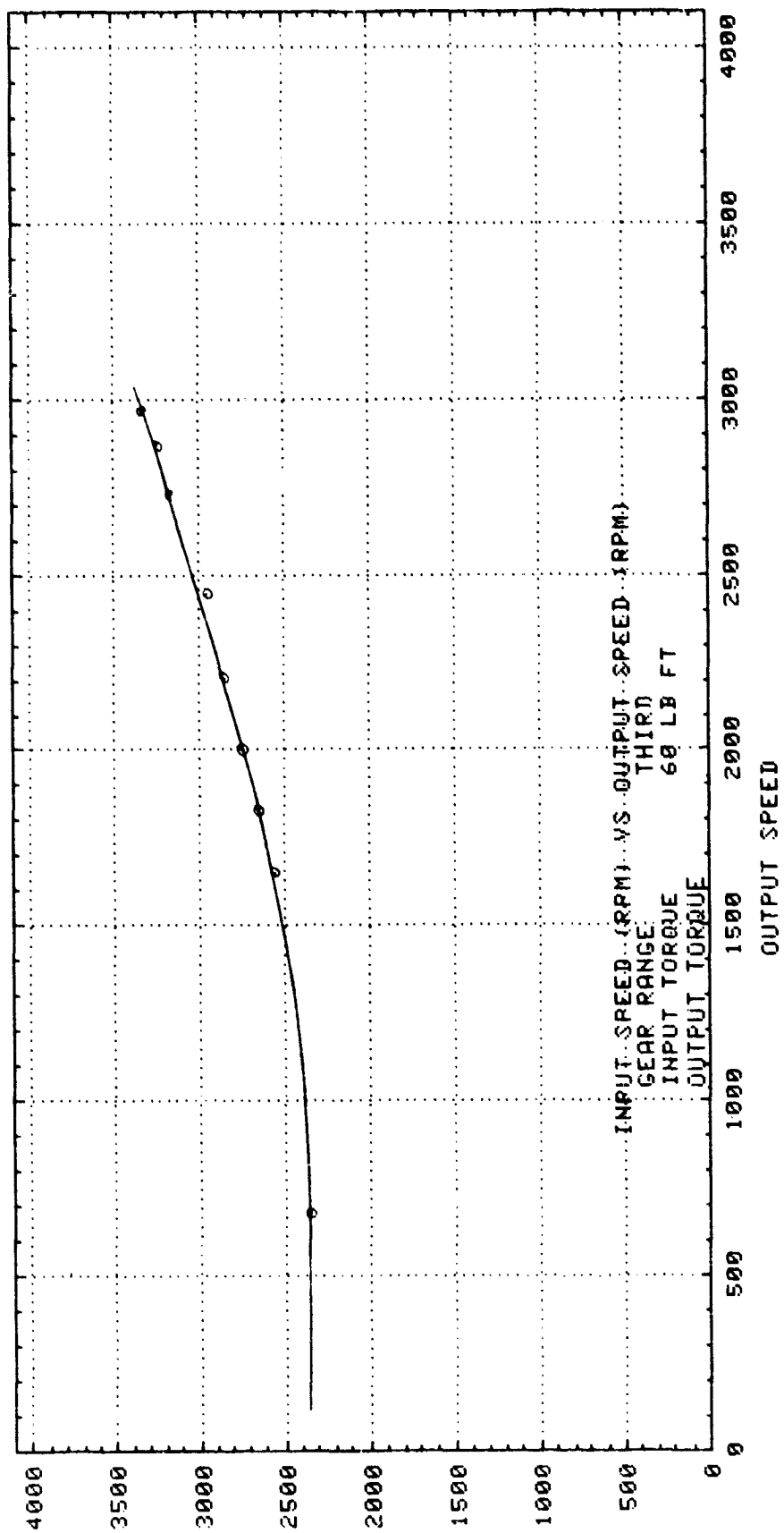

INPUT SPEED

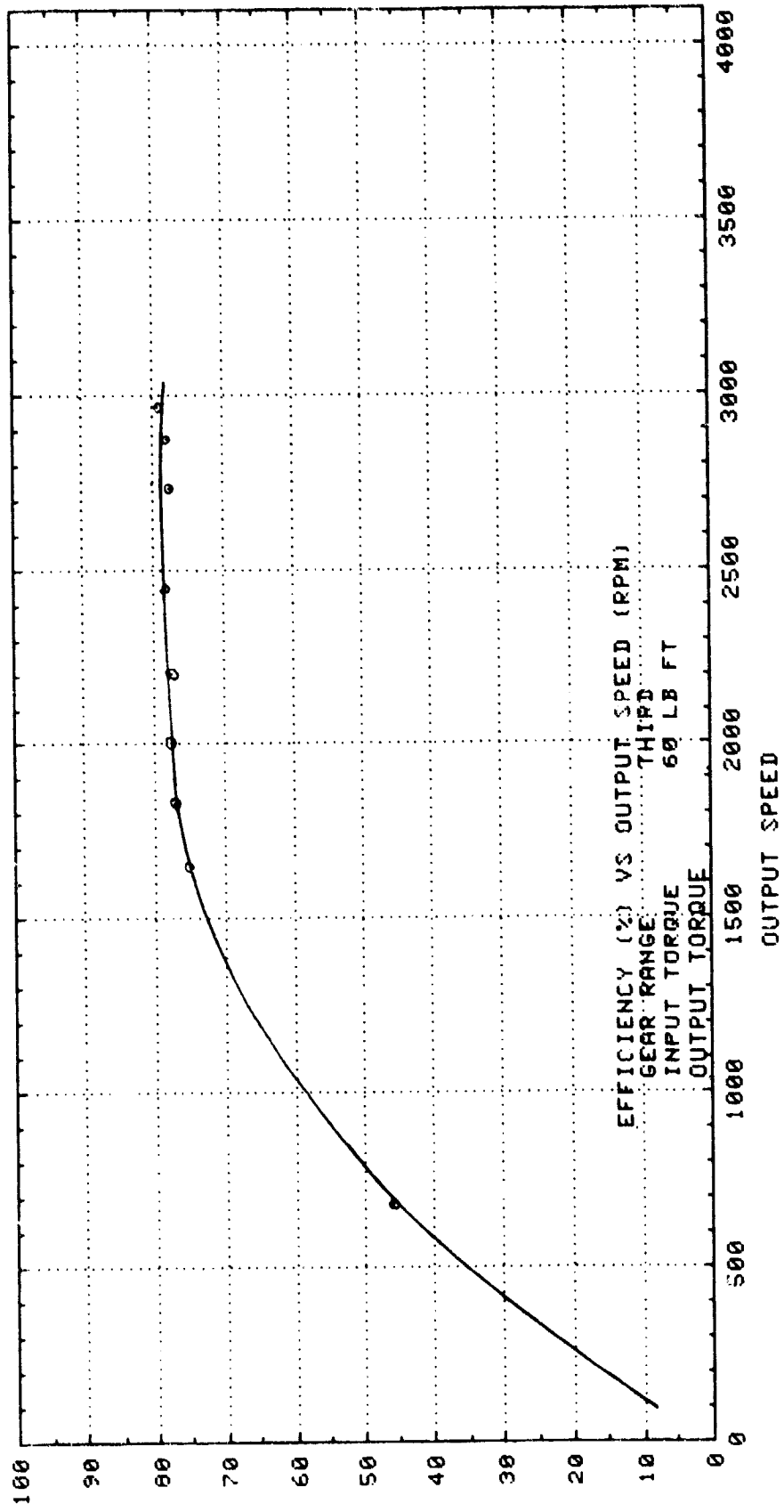

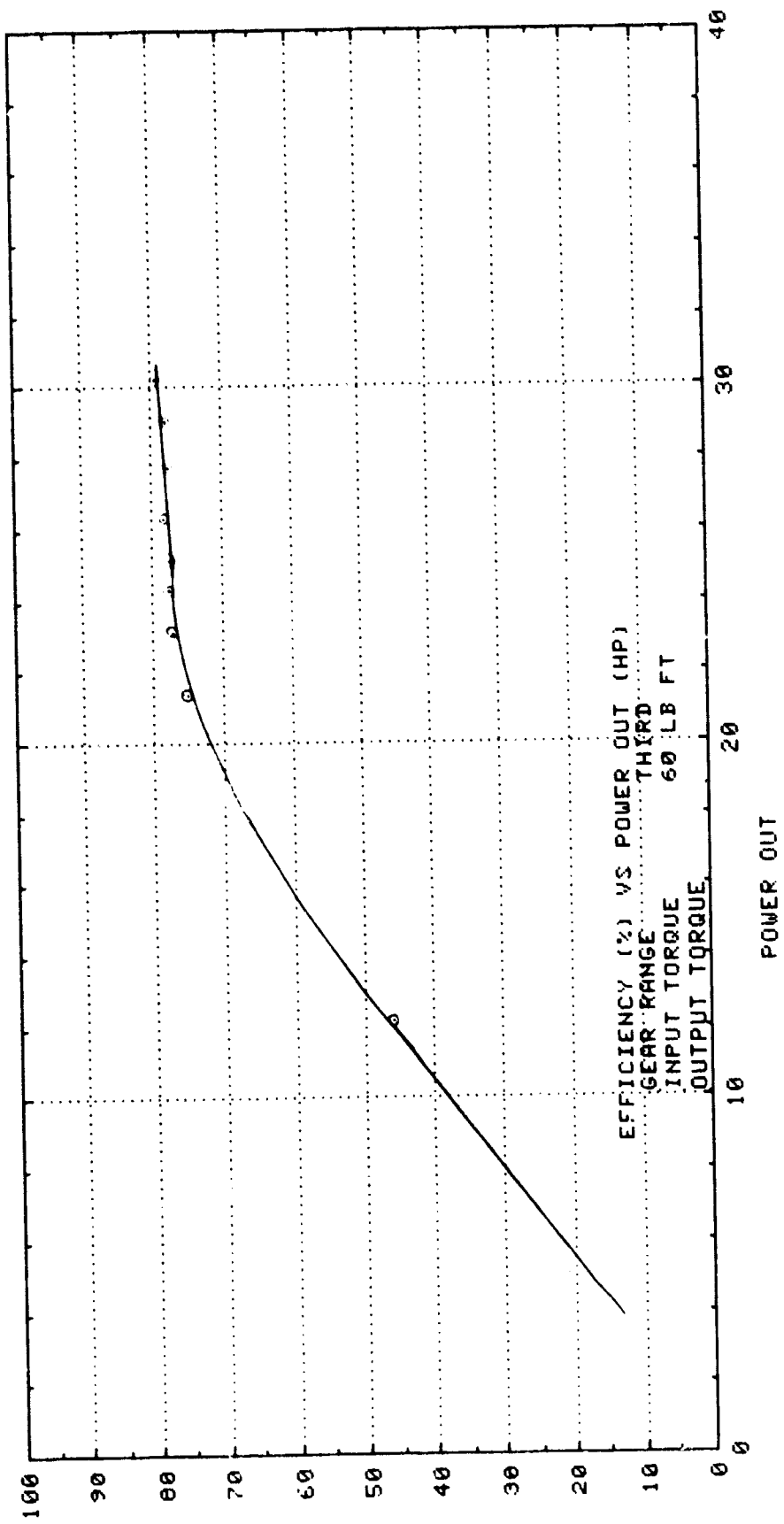

EFFICIENCY

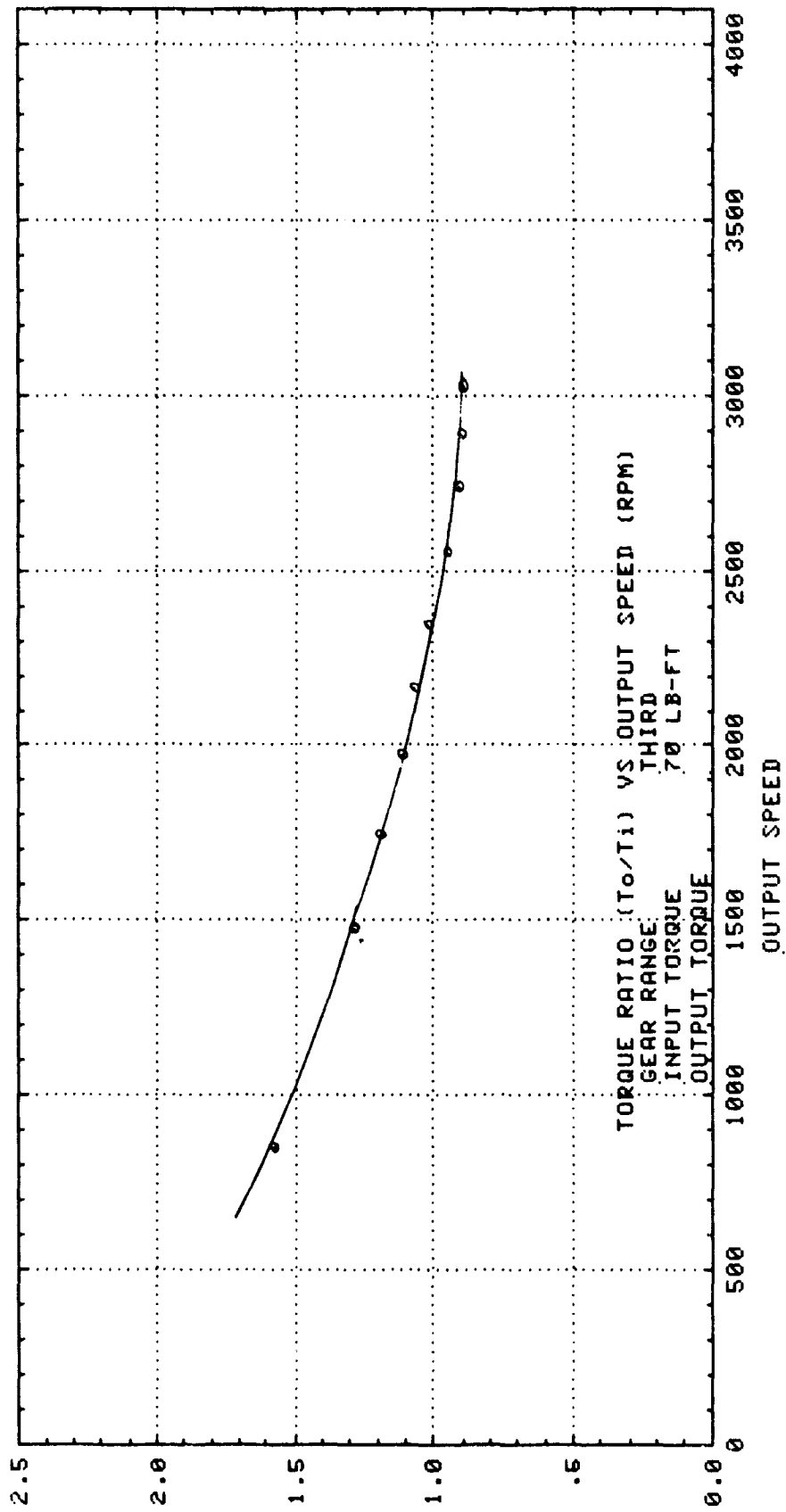

TORQUE RATIO

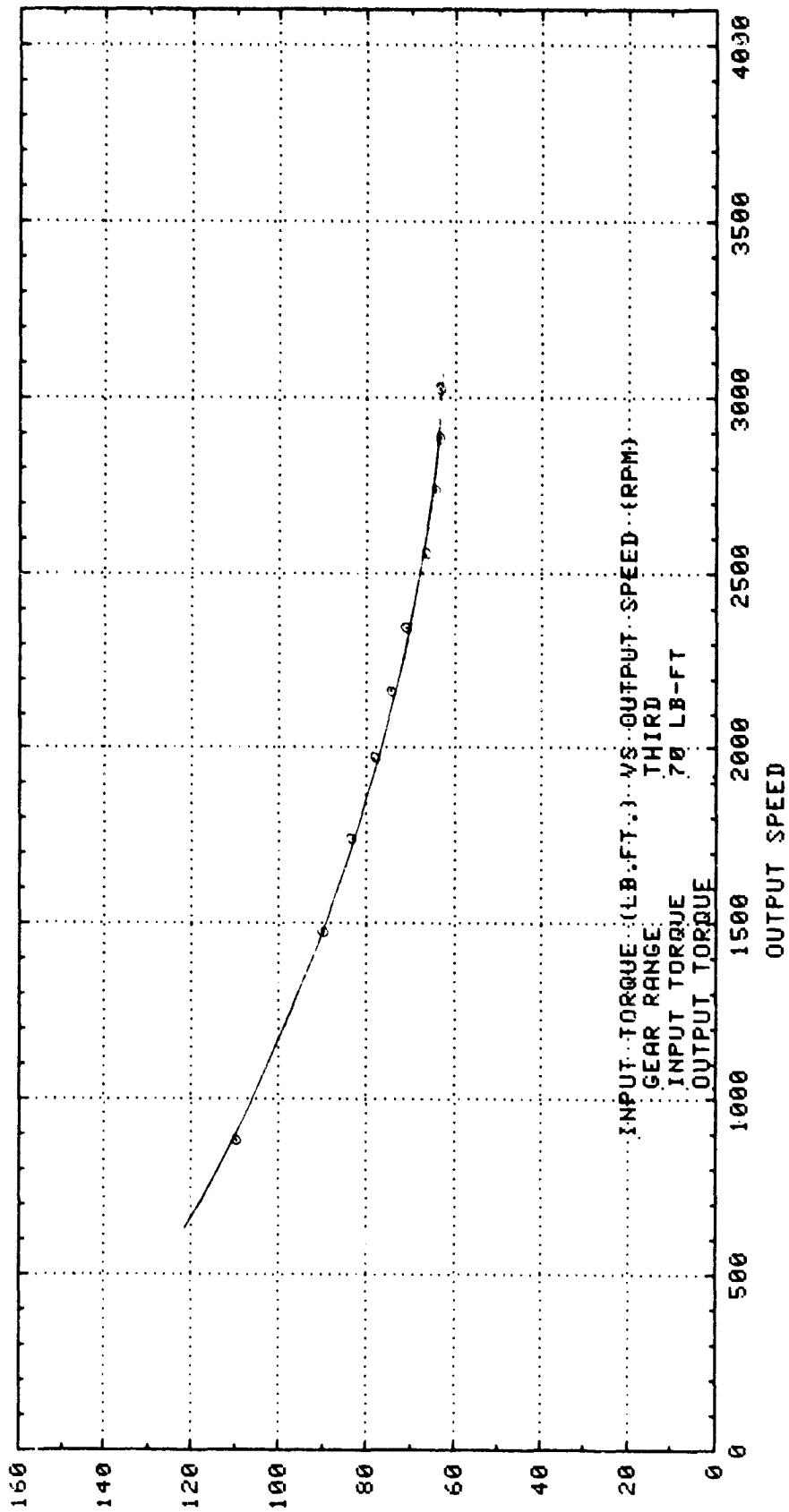

OUTPUT TORQUE

I N P U T   S P E E D

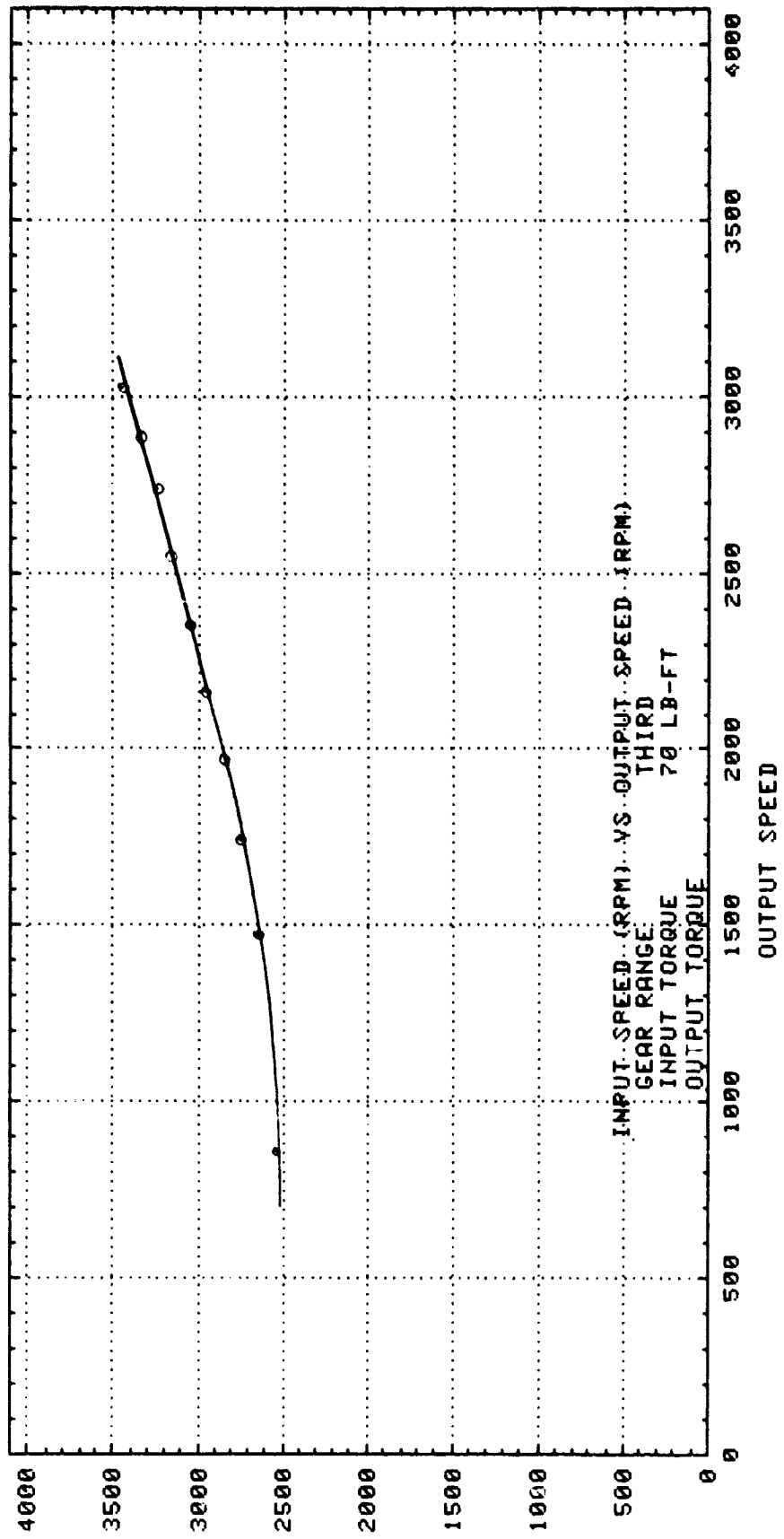

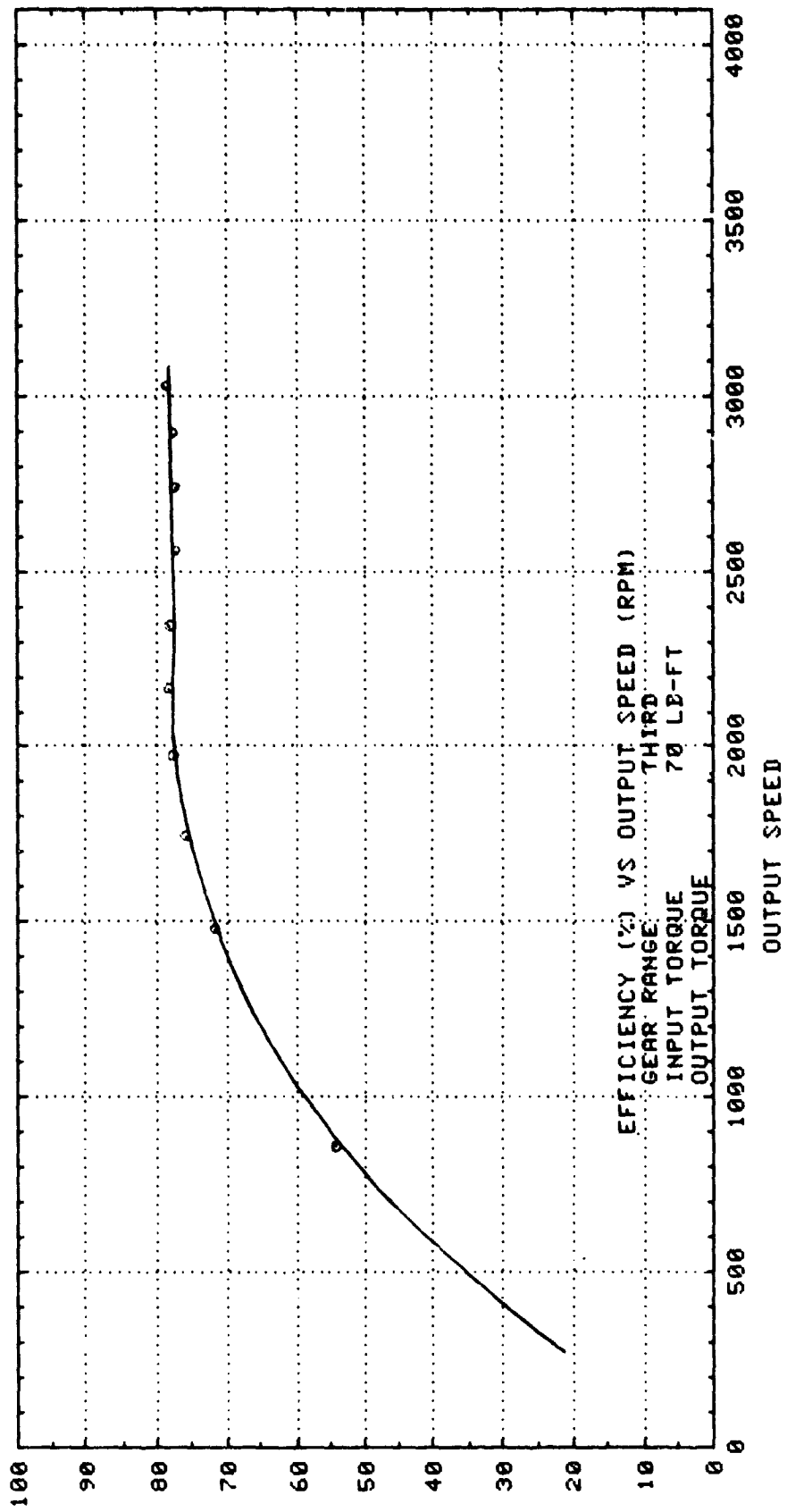

EFFICIENCY

E F F I C I E N C Y

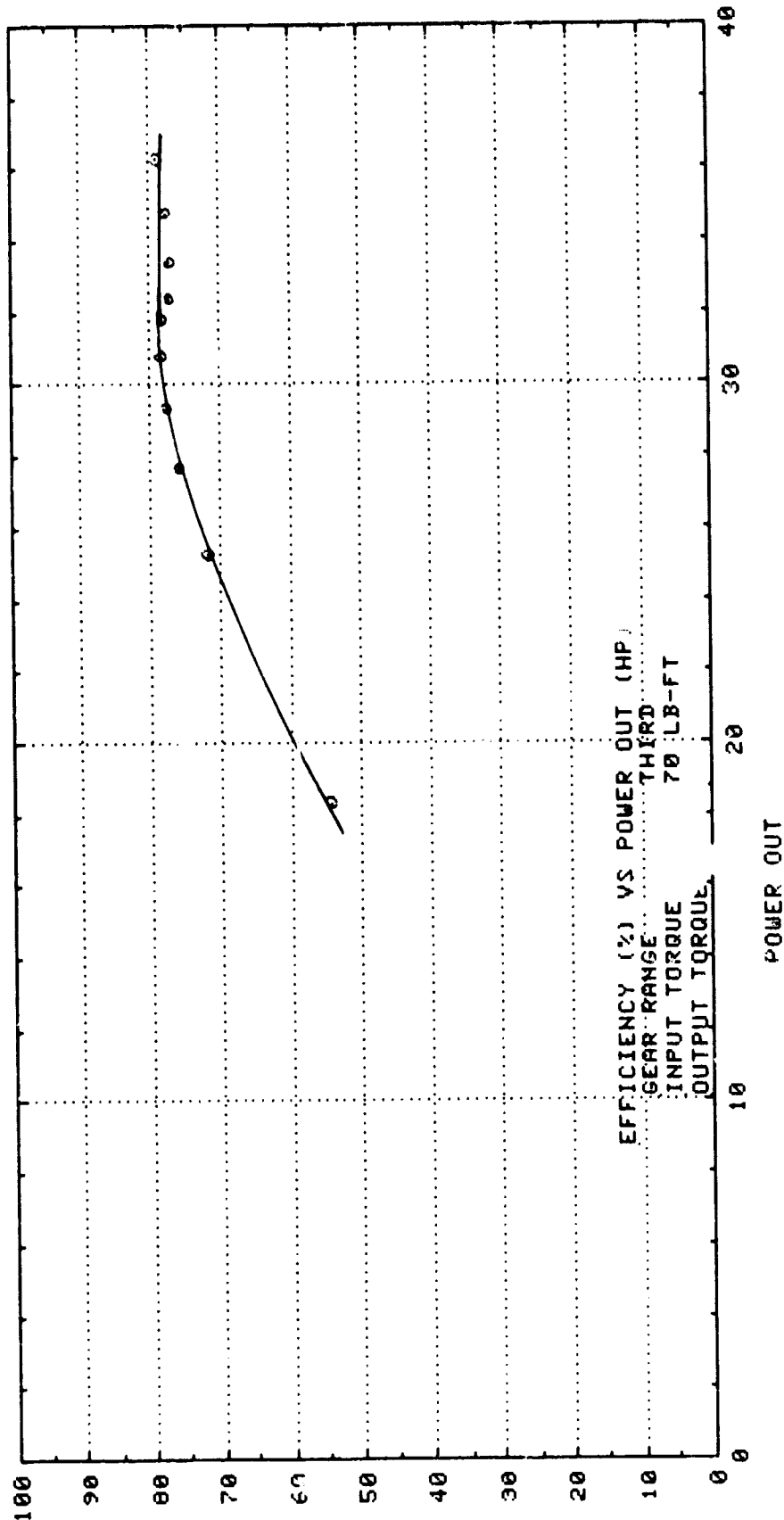



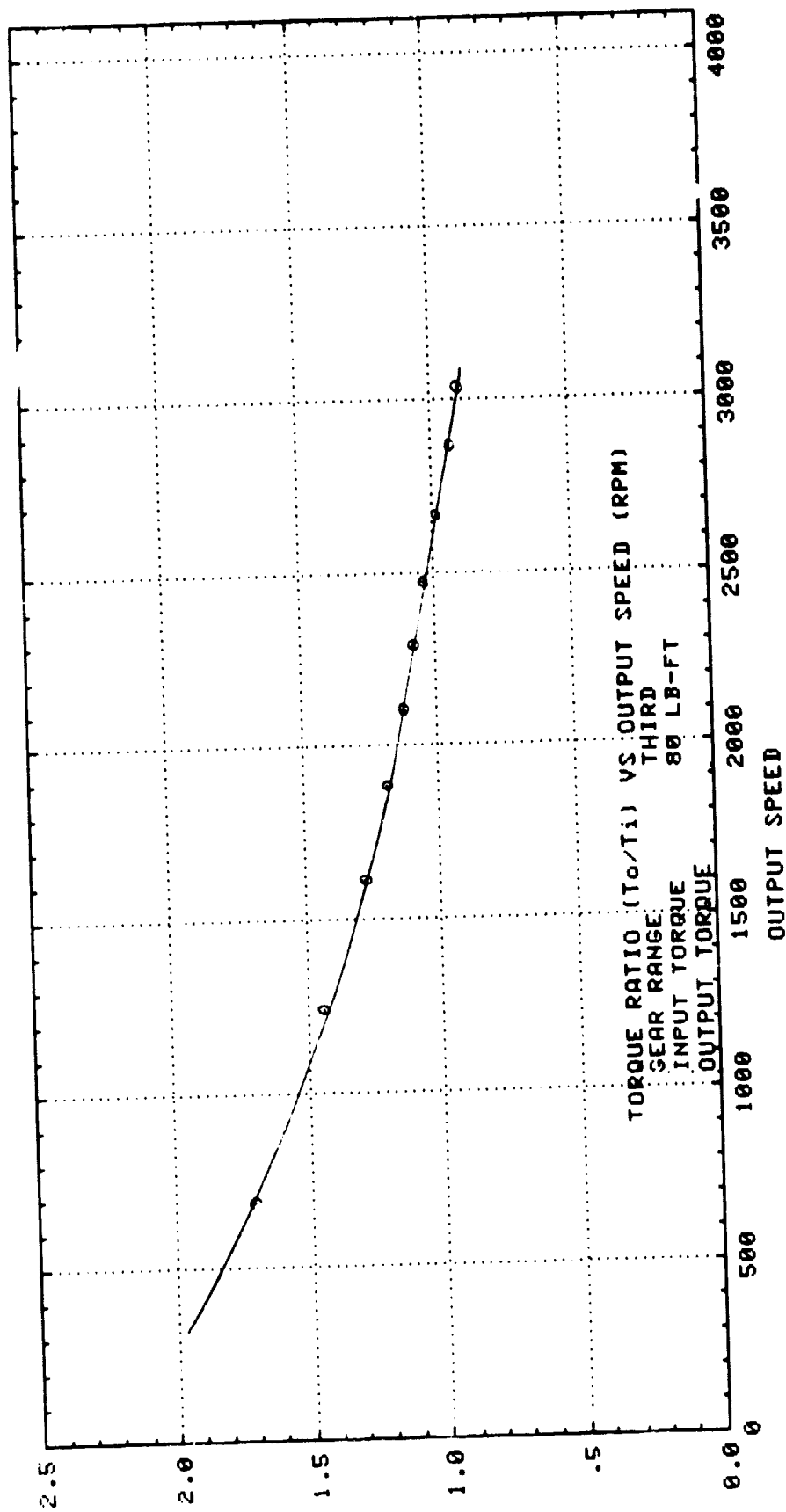

TORQUE RATIO

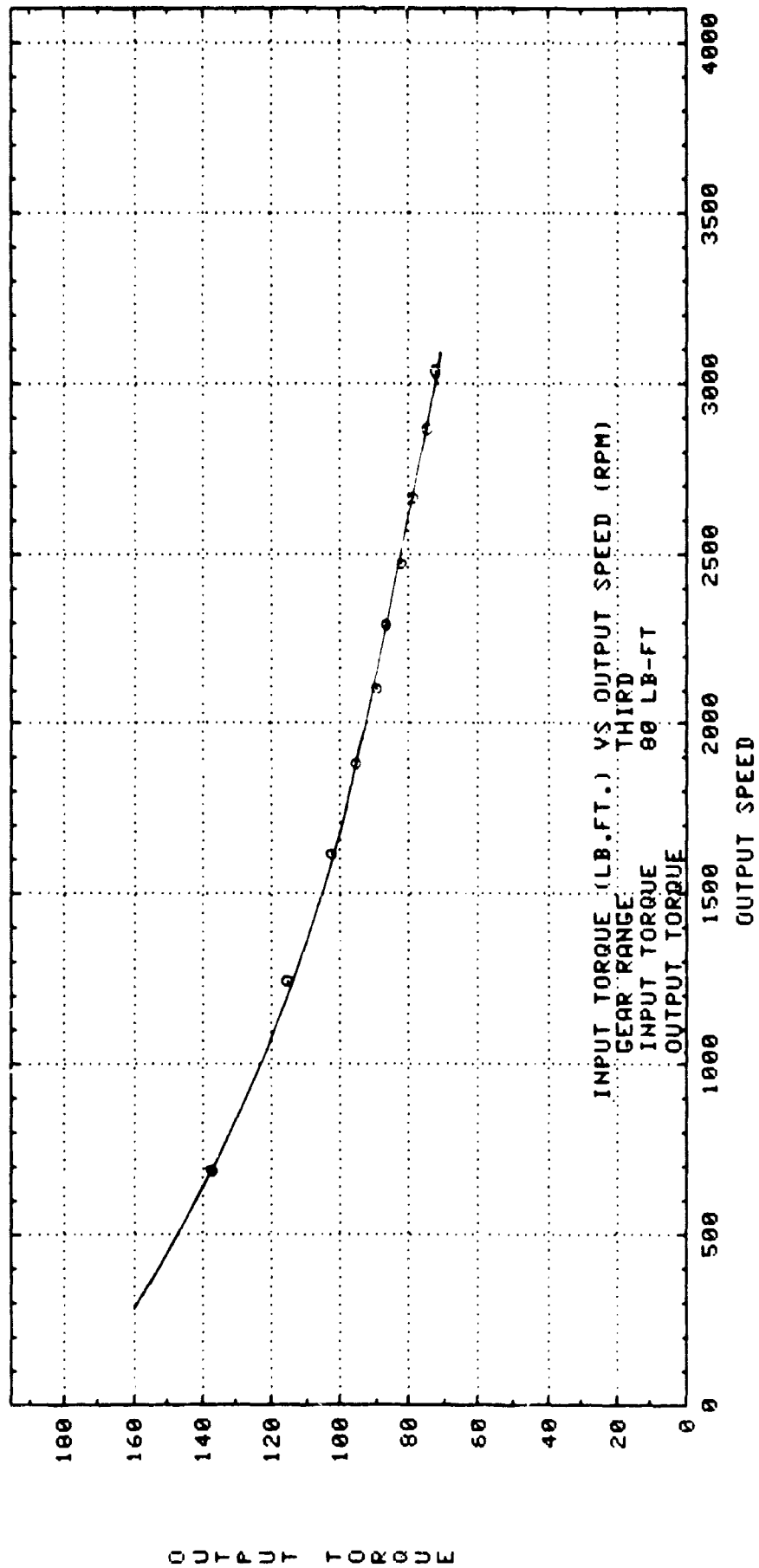

OUTPUT TORQUE

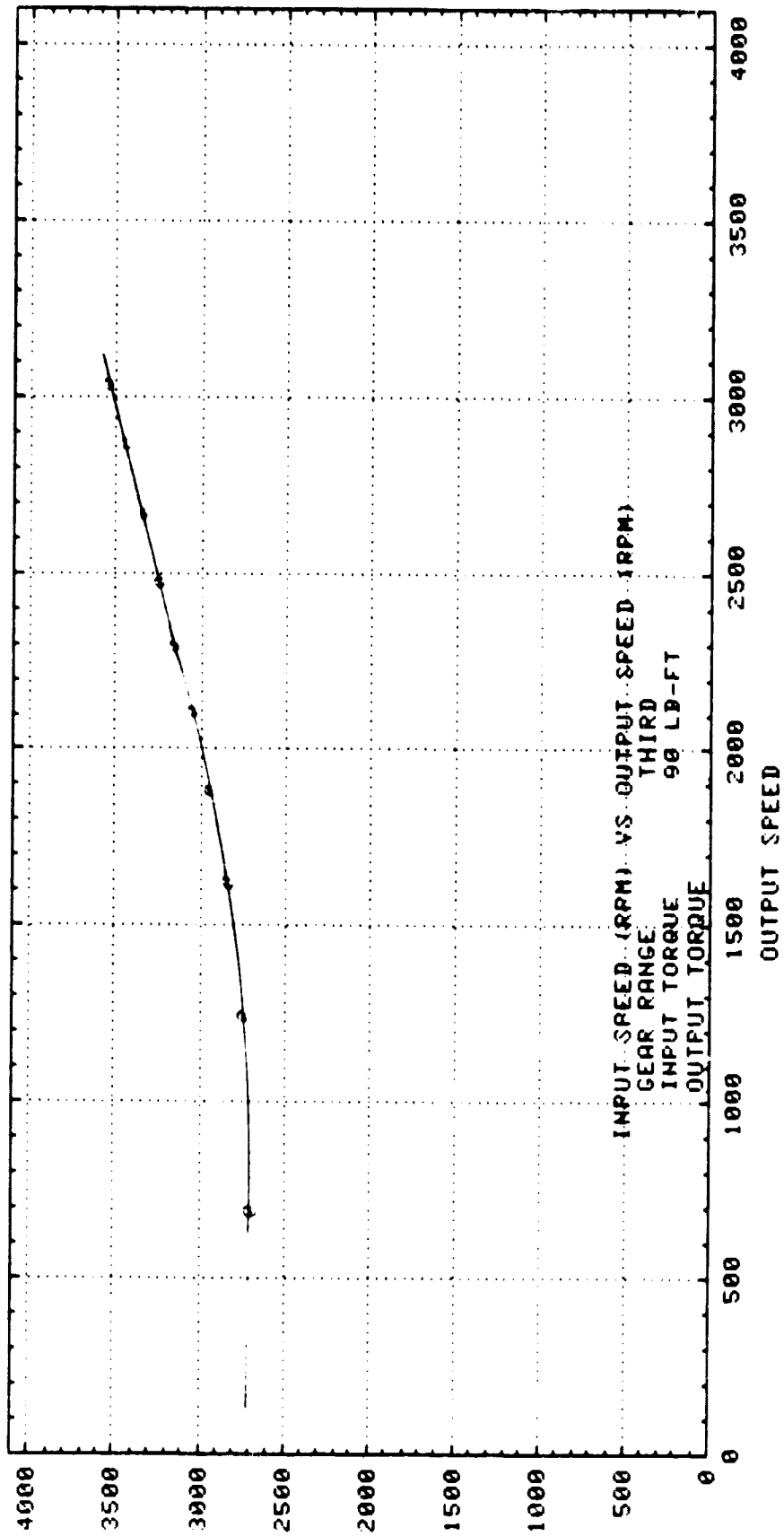

INPUT SPEED

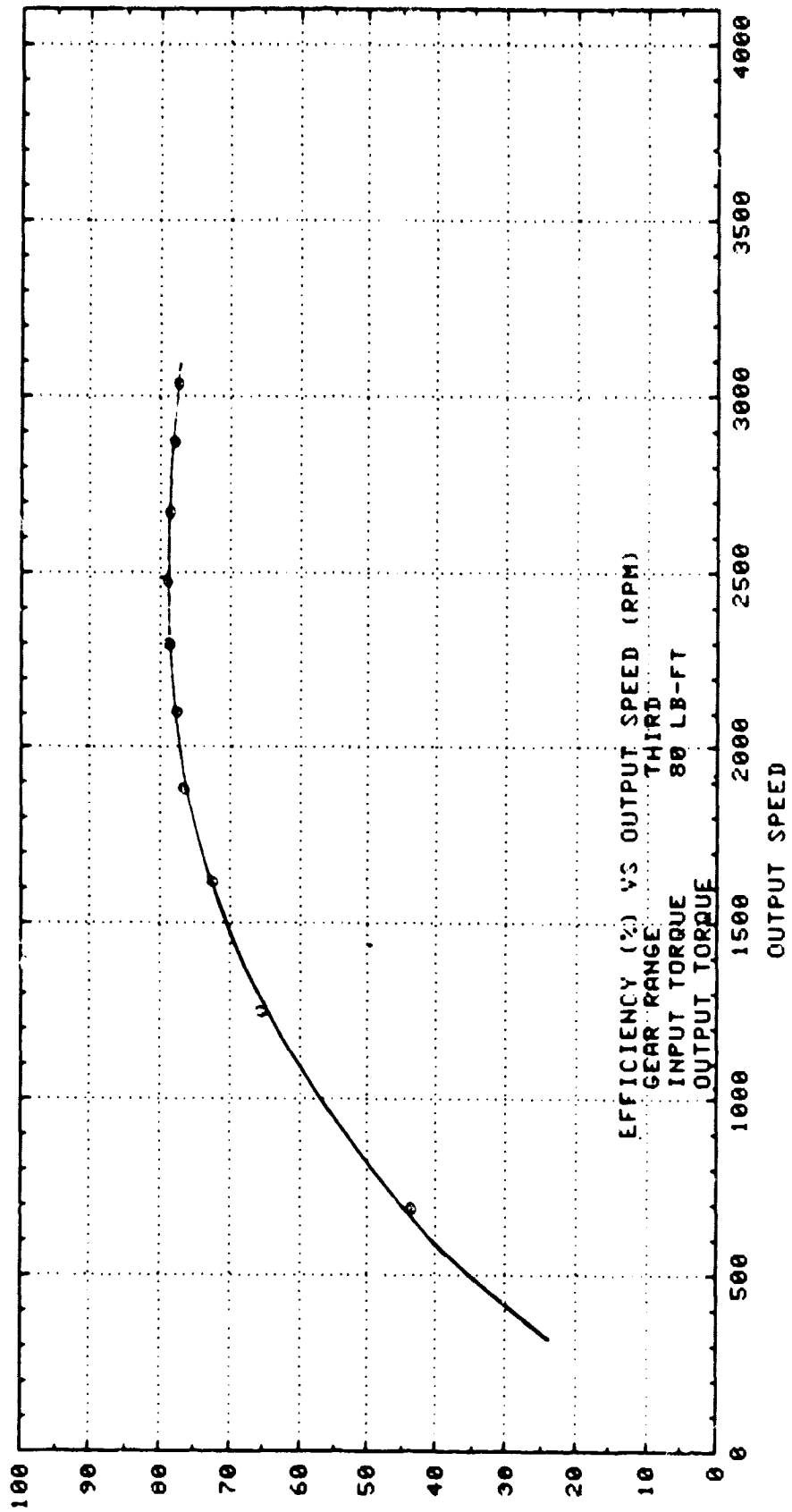

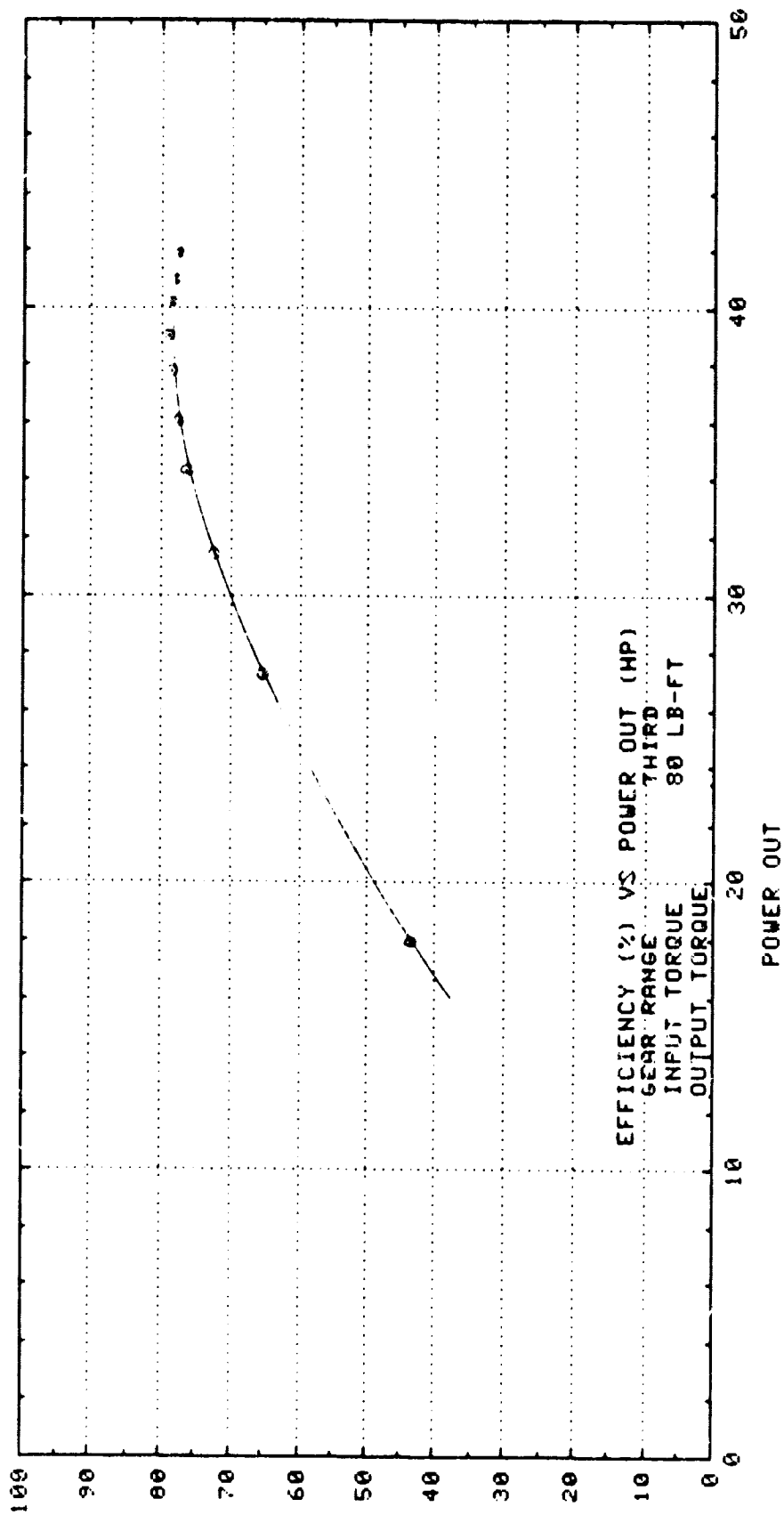

EFFICIENCY

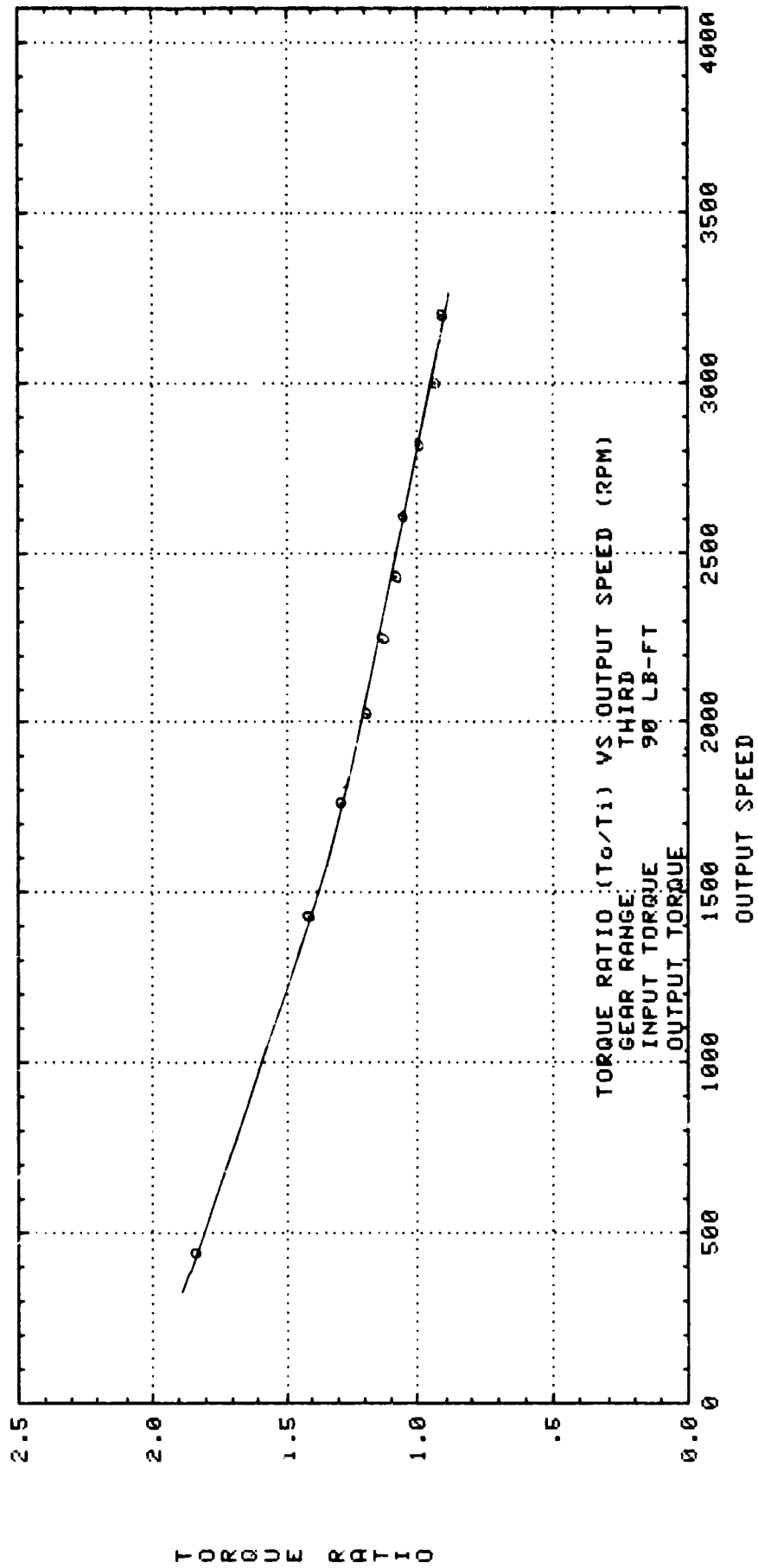

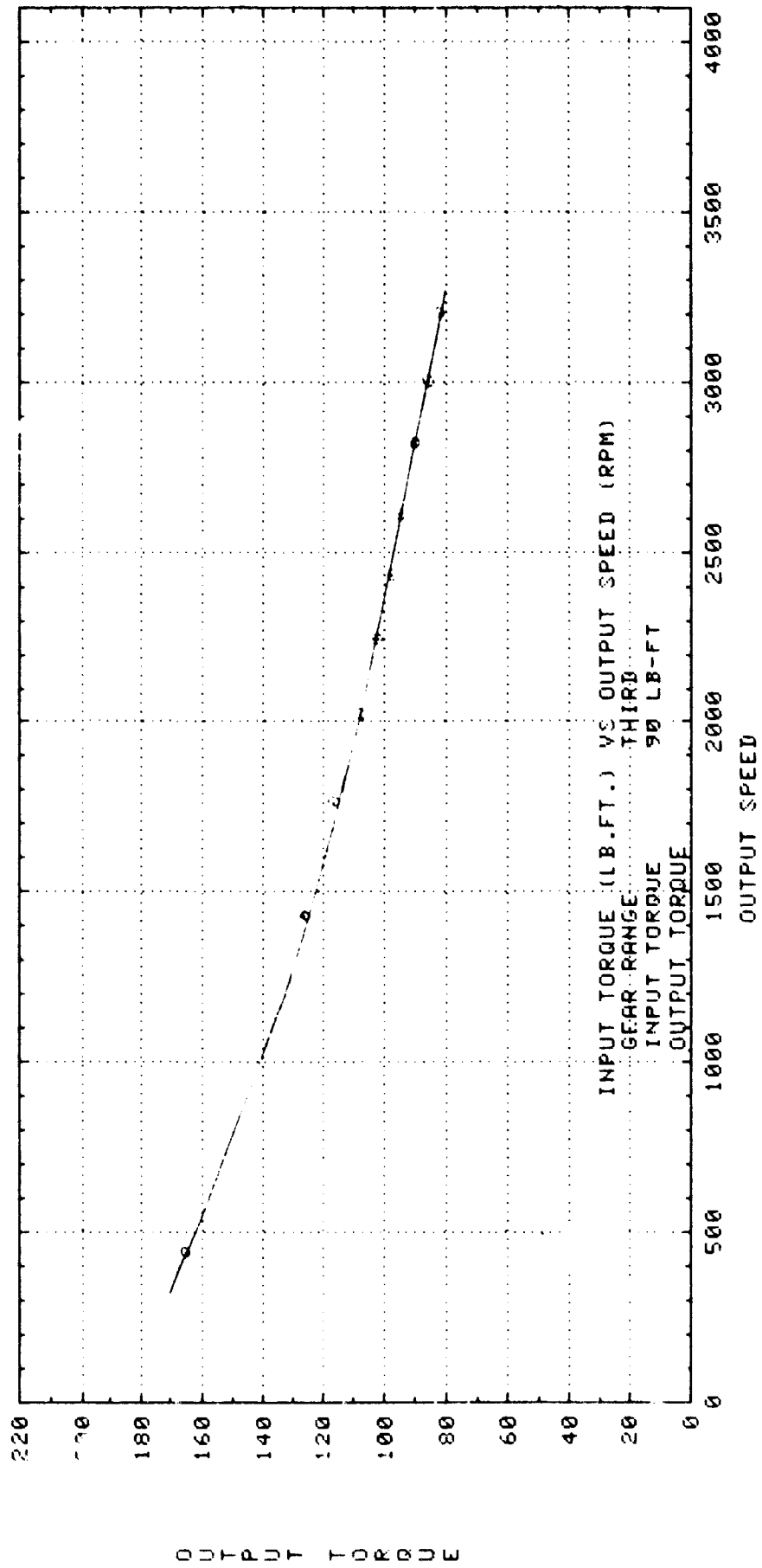

OUTPUT TORQUE

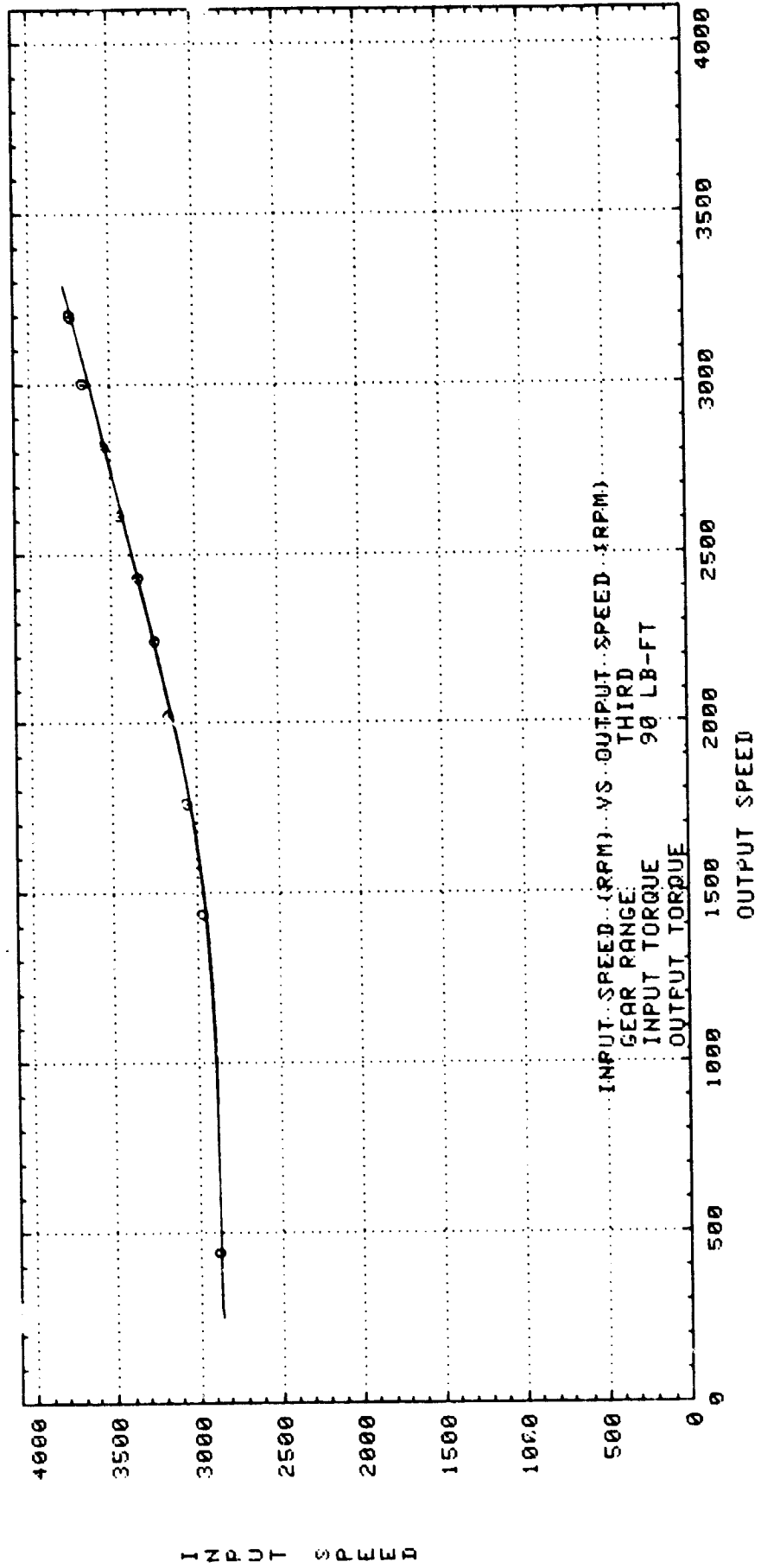

INPUT SPEED

OUTPUT SPEED



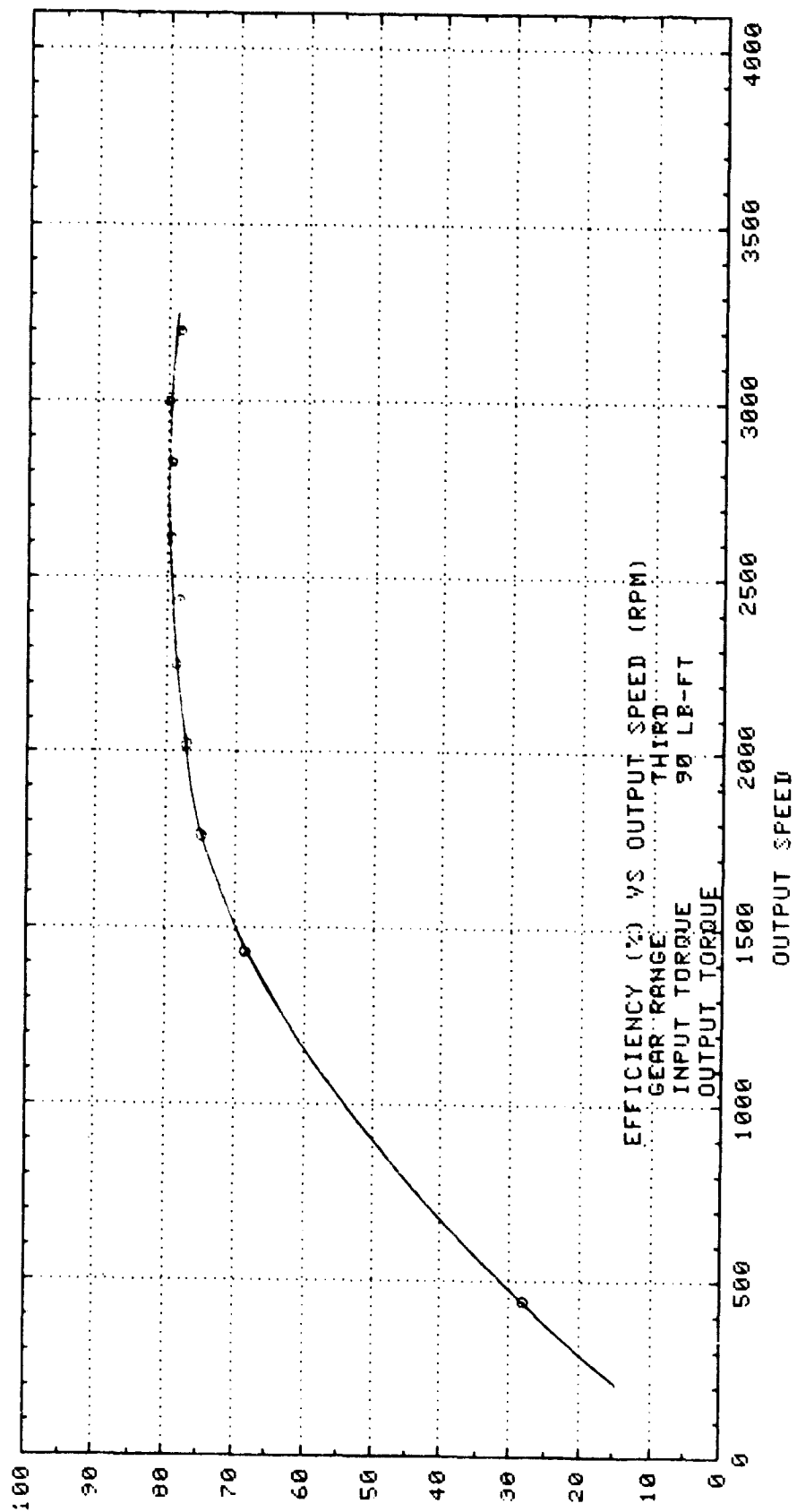

EFFICIENCY

EFFICIENCY

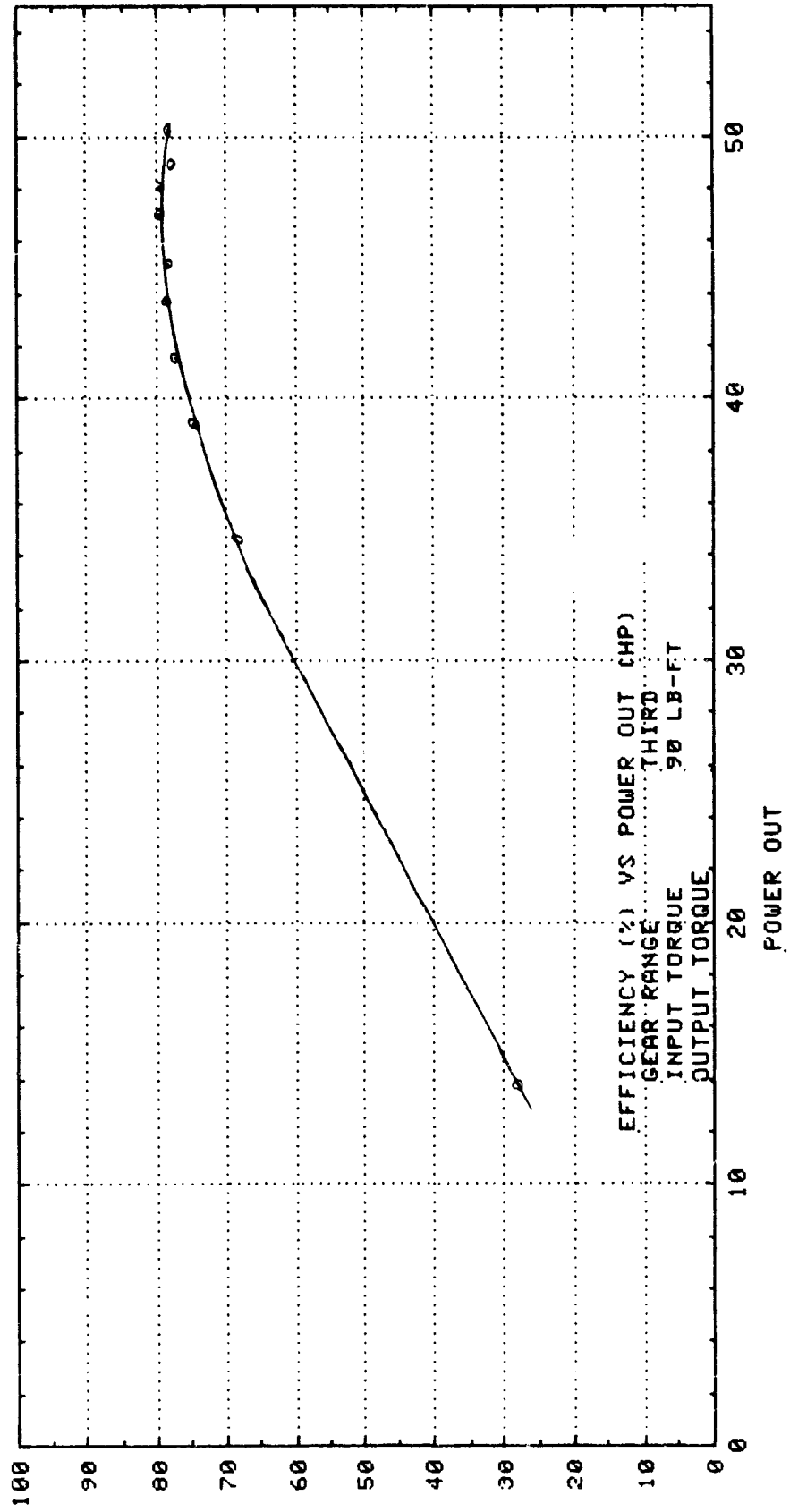

CROSS SECTIONAL ROAD LOAD PERFORMANCE

3rd GEAR

## Graphs Contained in This Section

Torque Ratio -vs- Output Speed

Output Torque -vs- Output Speed

Input Speed -vs- Output Speed

Efficiency -vs- Output Speed

Efficiency -vs- Power Out

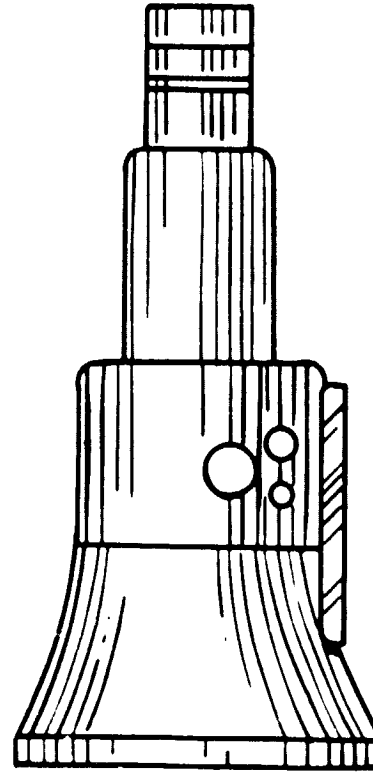

Torque In

Speed In

Torque Out

Speed Out

---

**Drive Performance Tests**

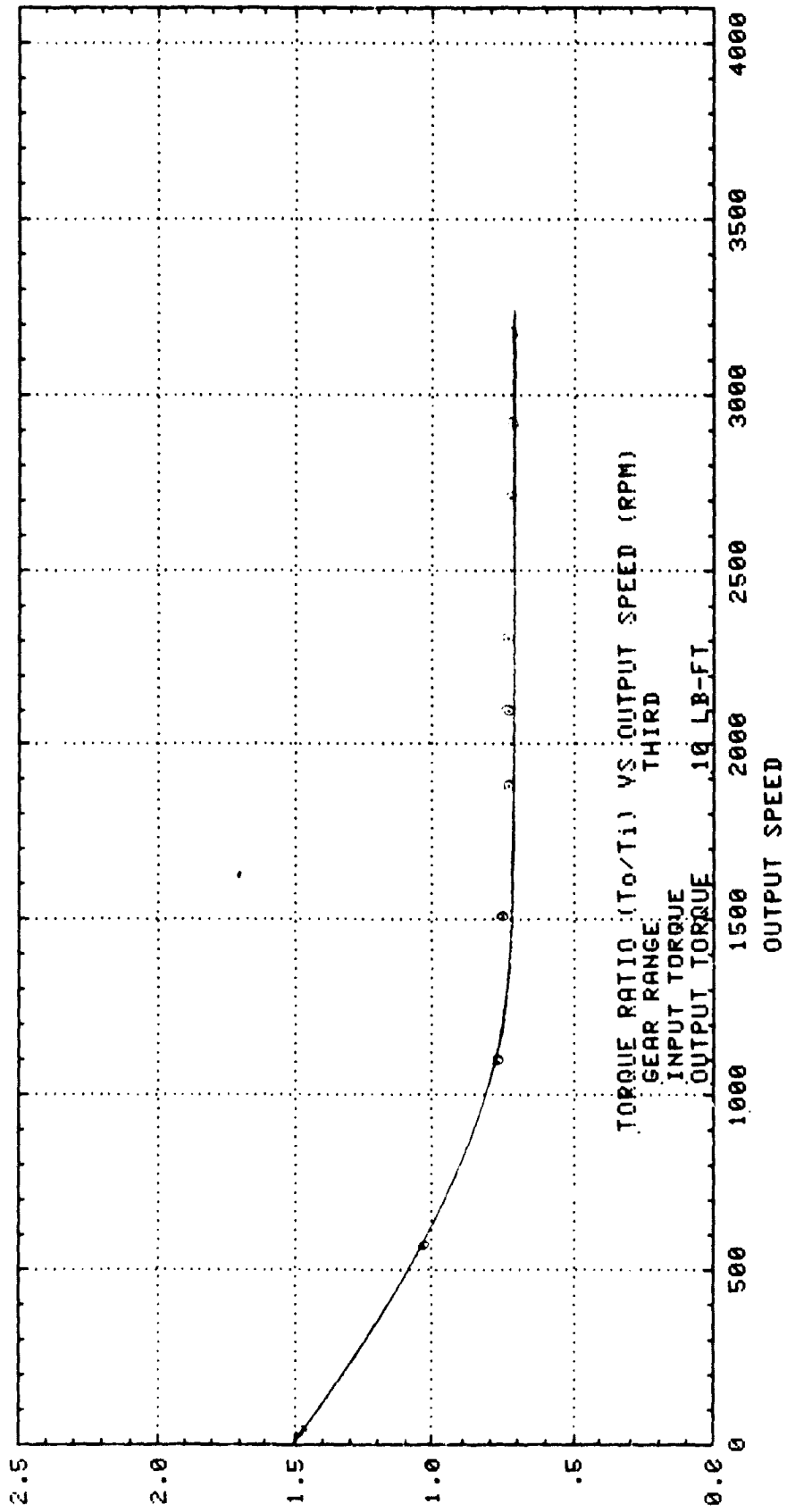

TORQUE RATIO

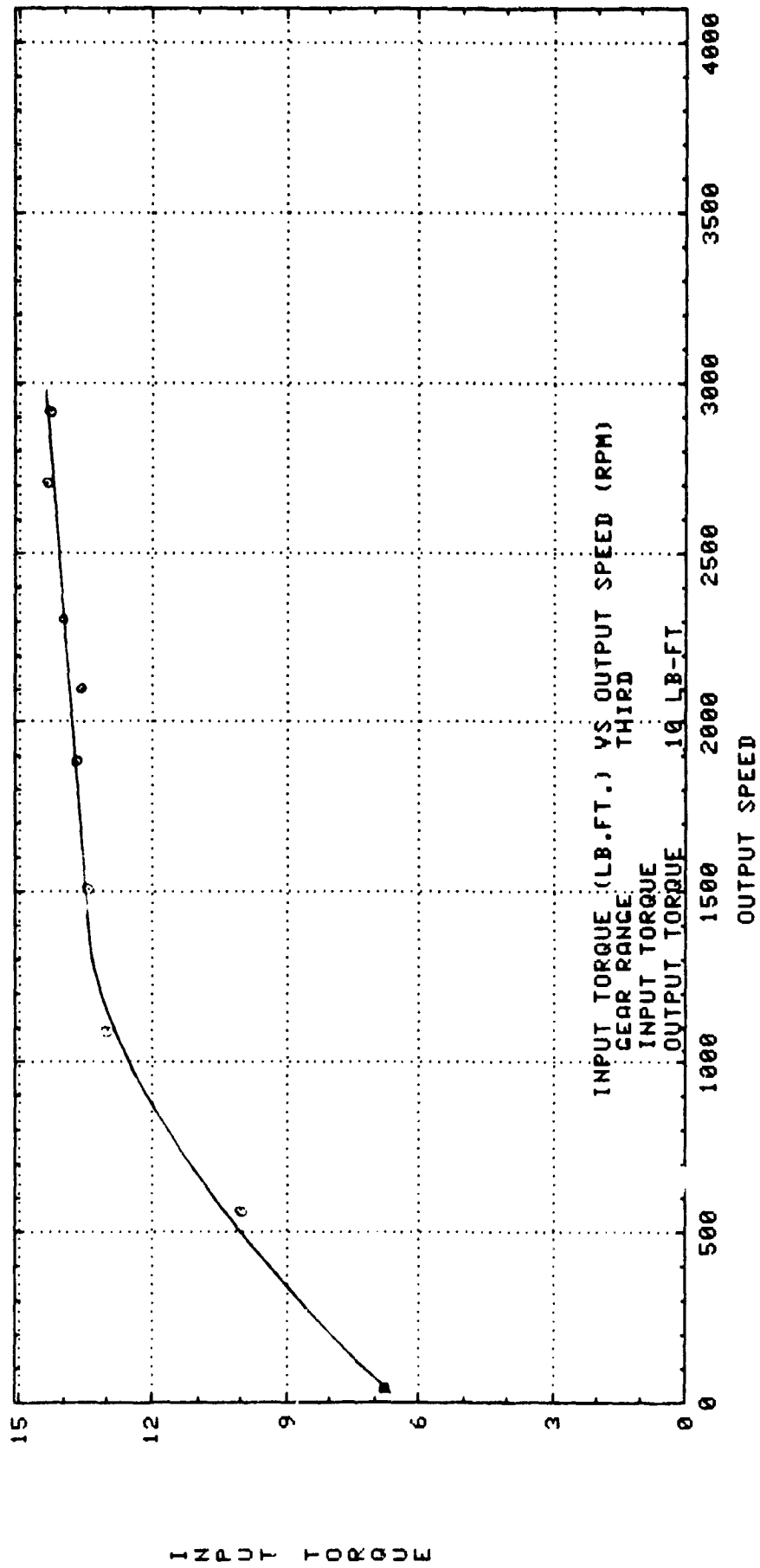

INPUT TORQUE

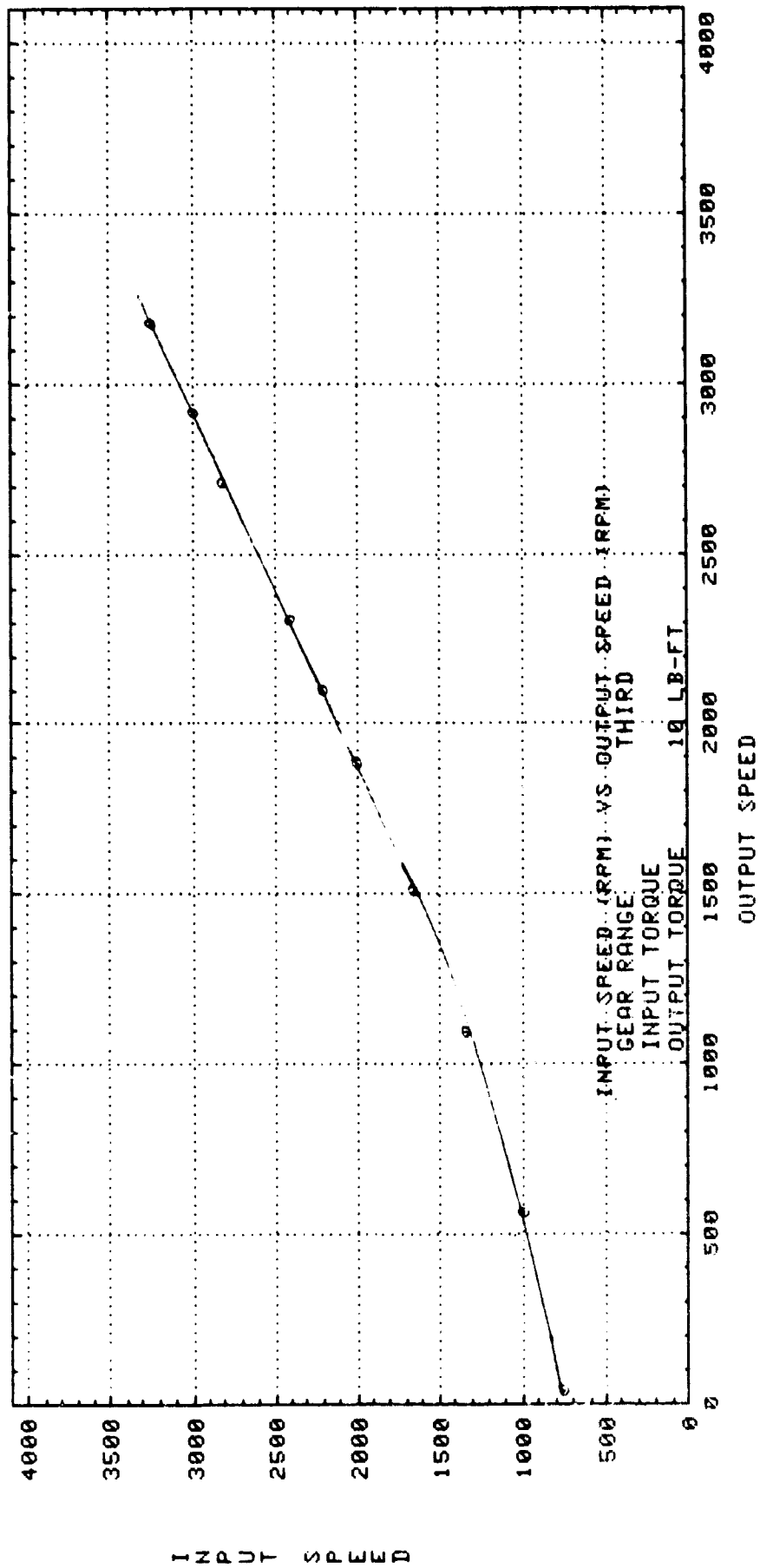

INPUT SPEED

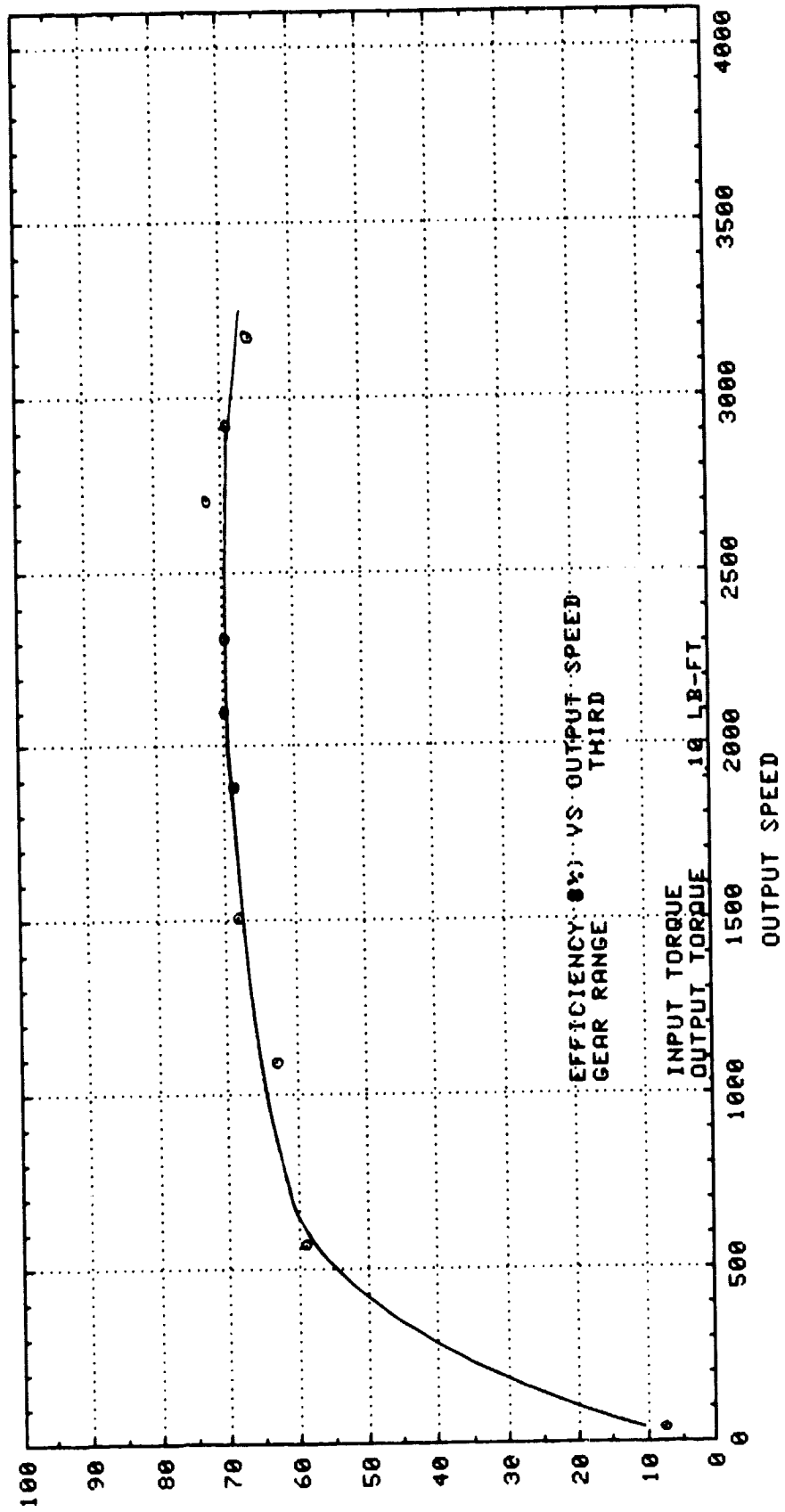

EFFICIENCY



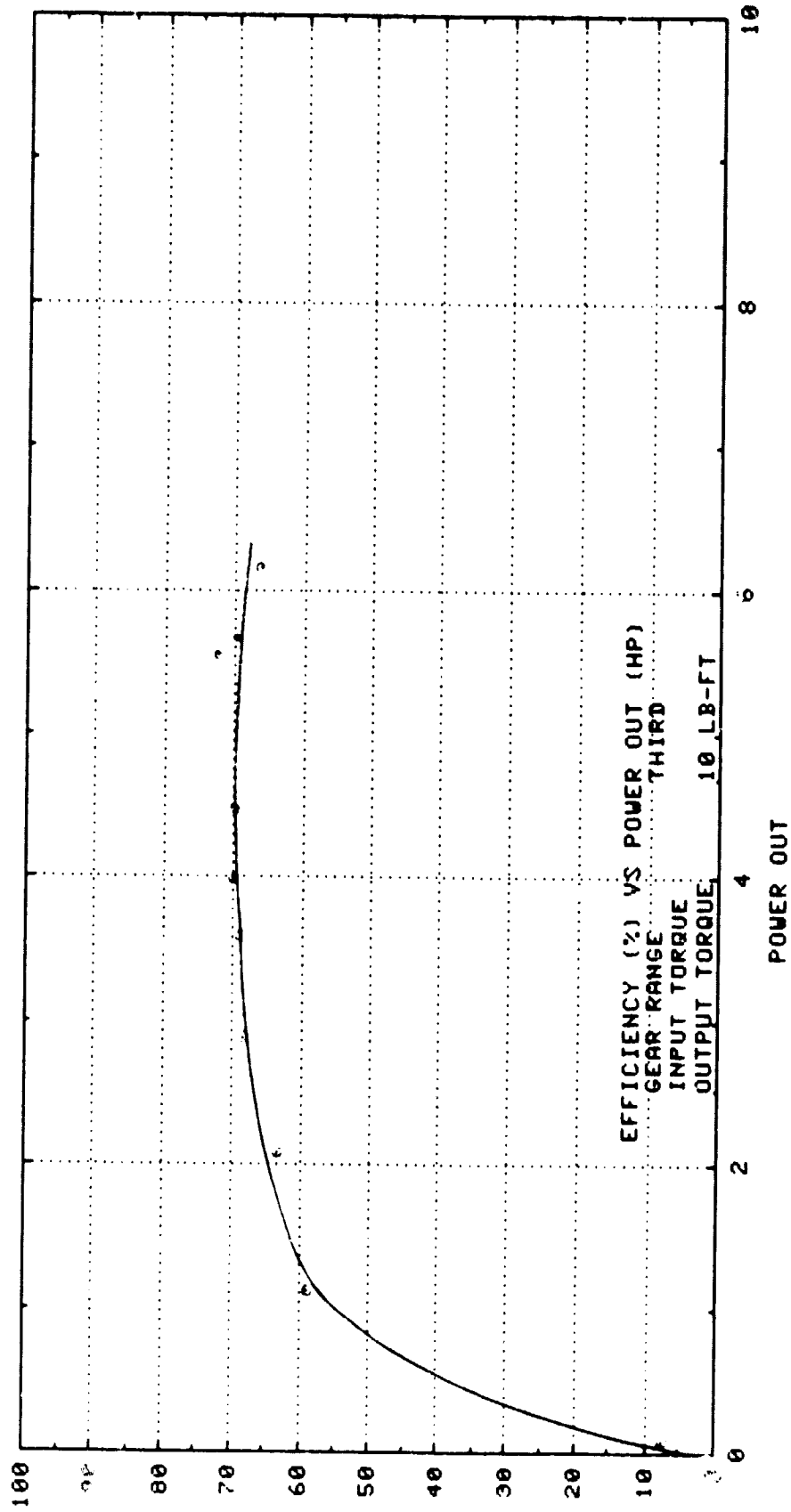

EFFICIENCY

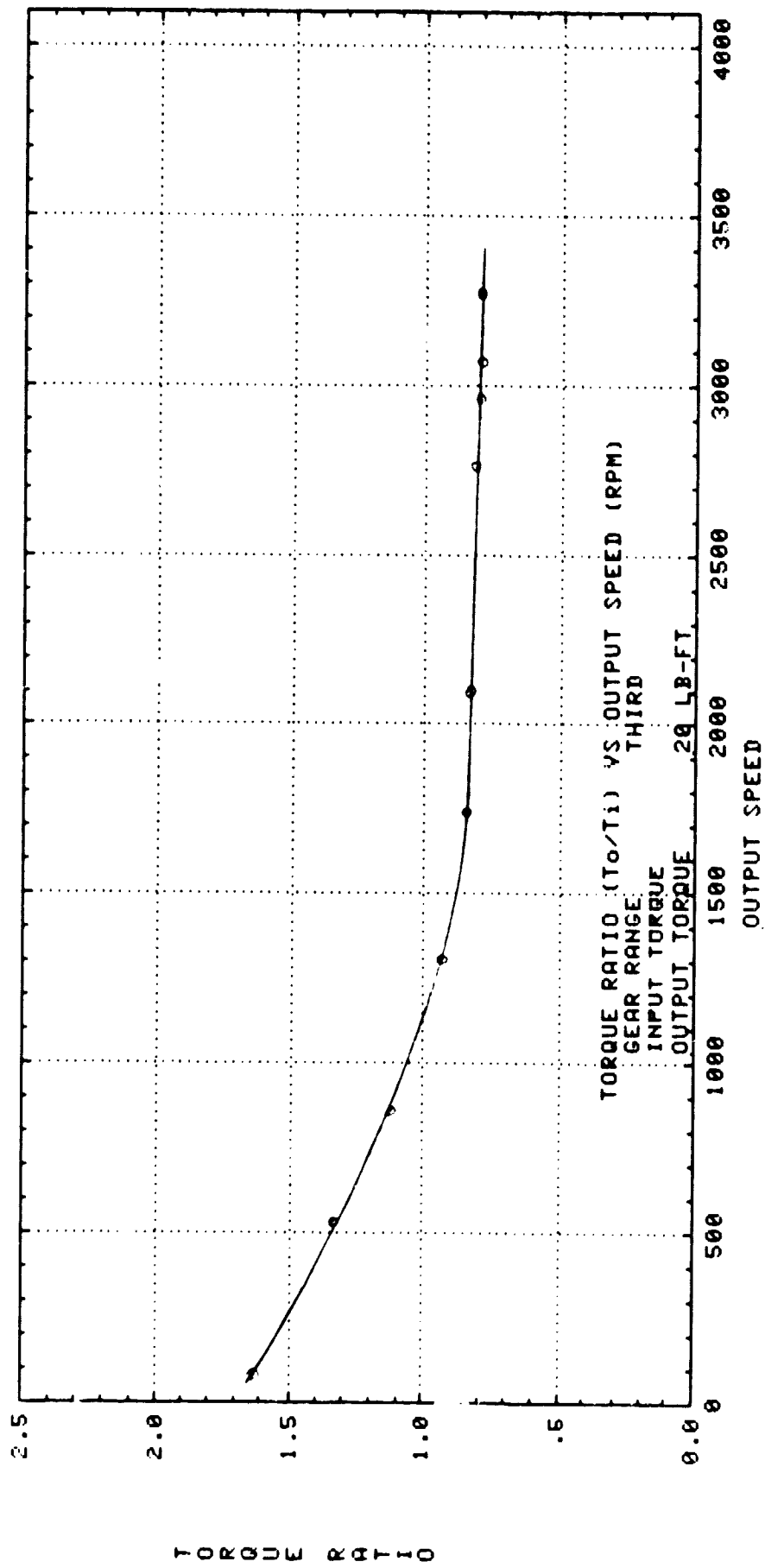

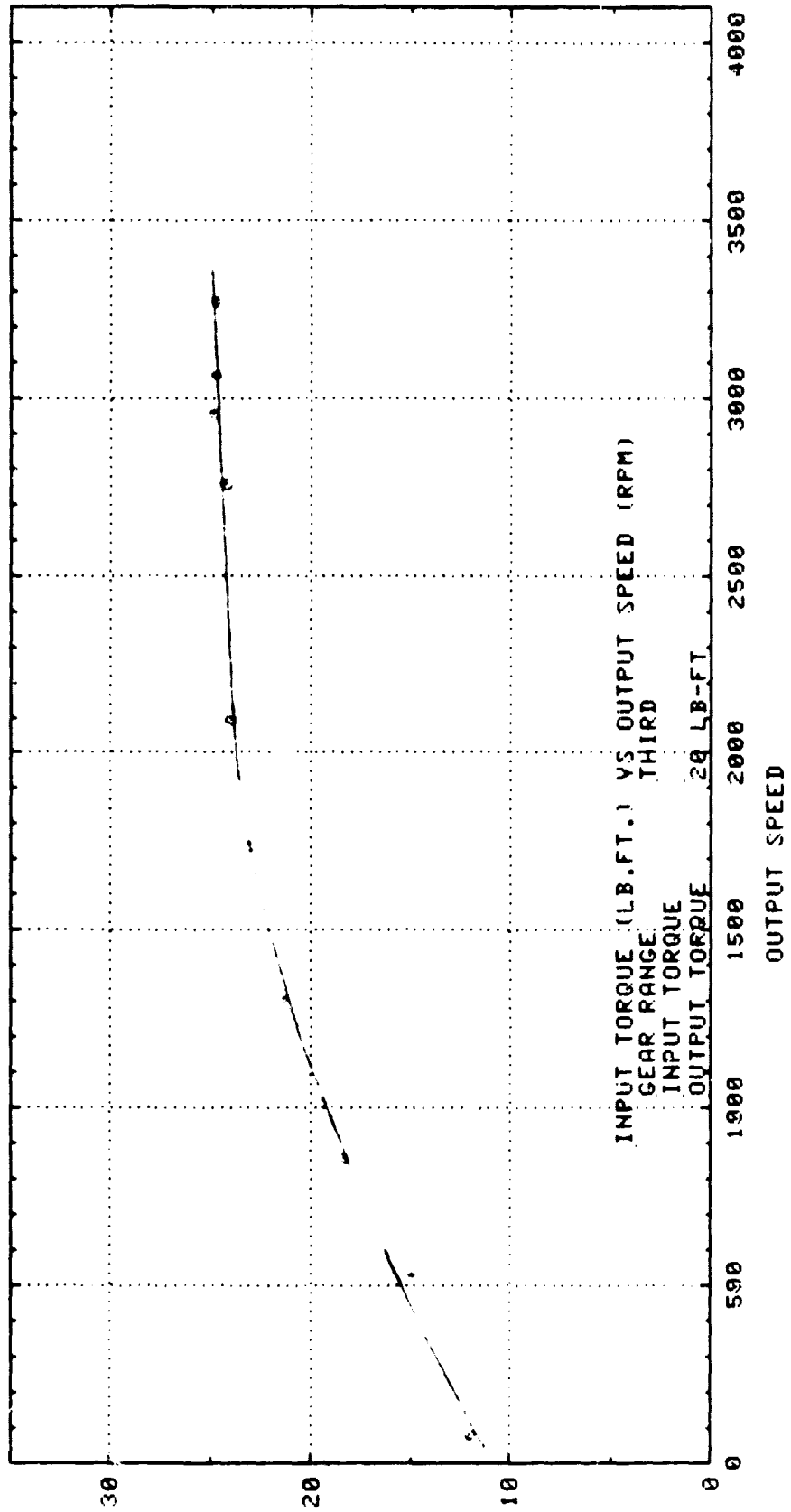

INPUT TORQUE

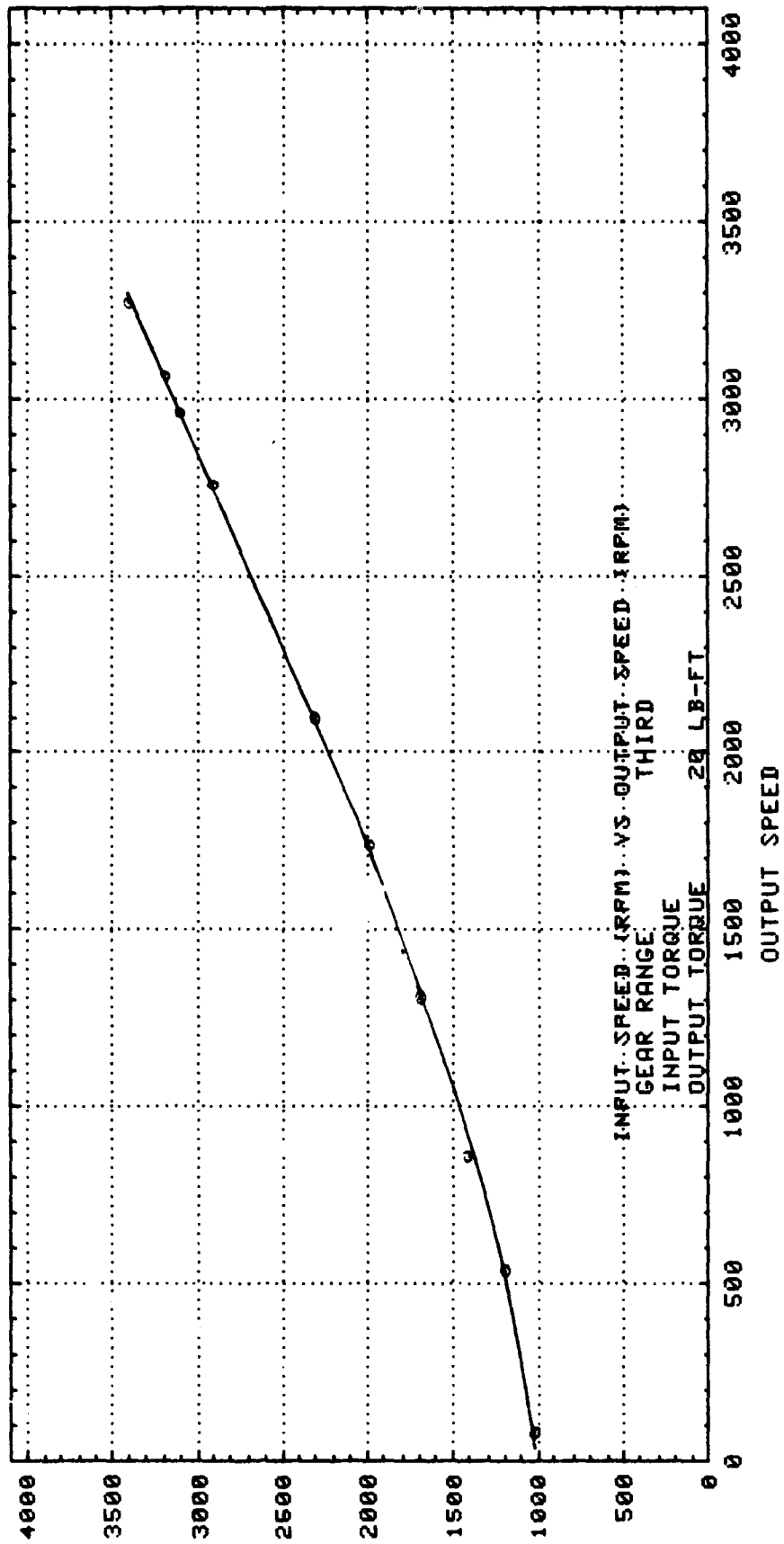

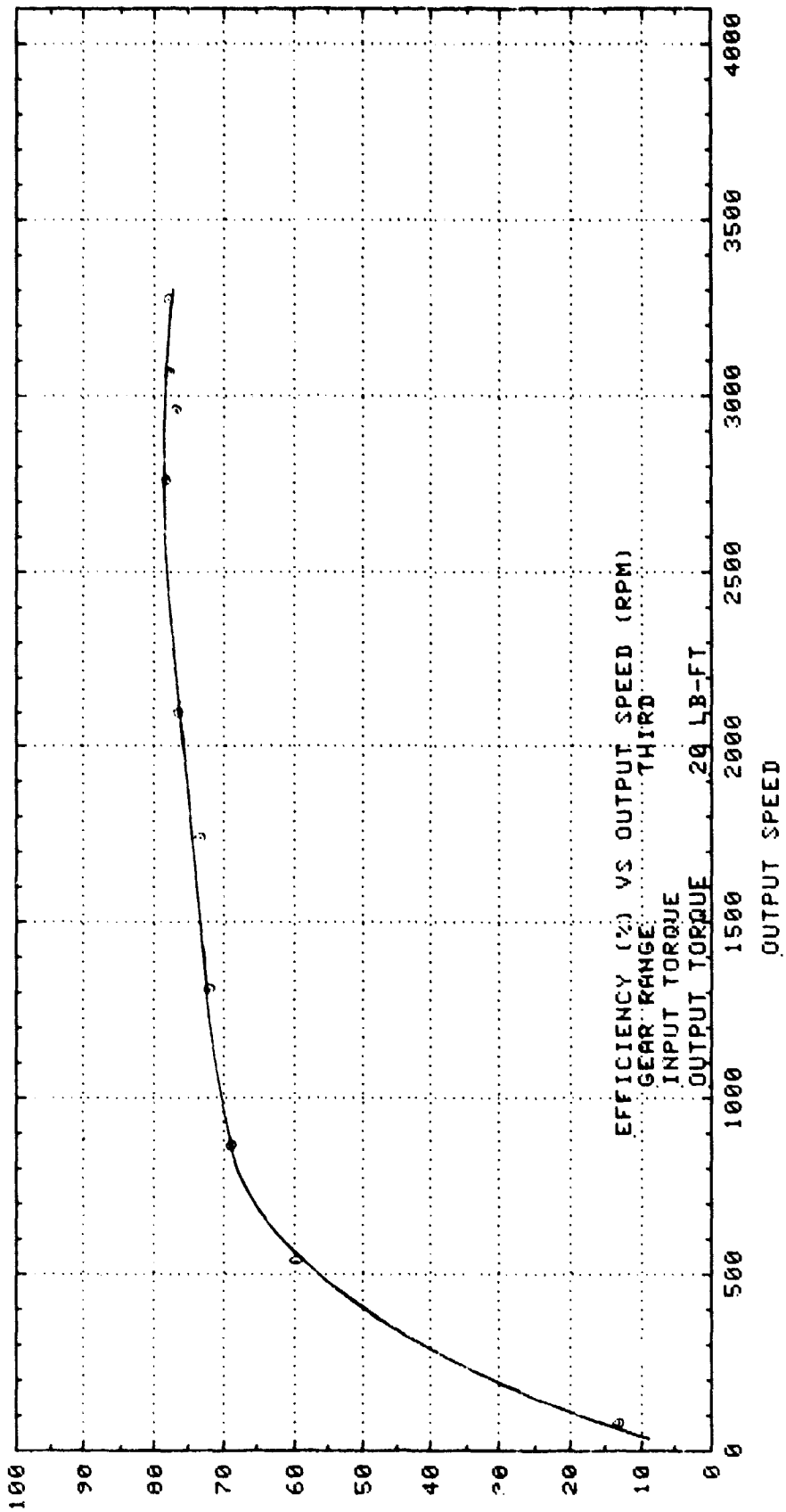

EFFICIENCY

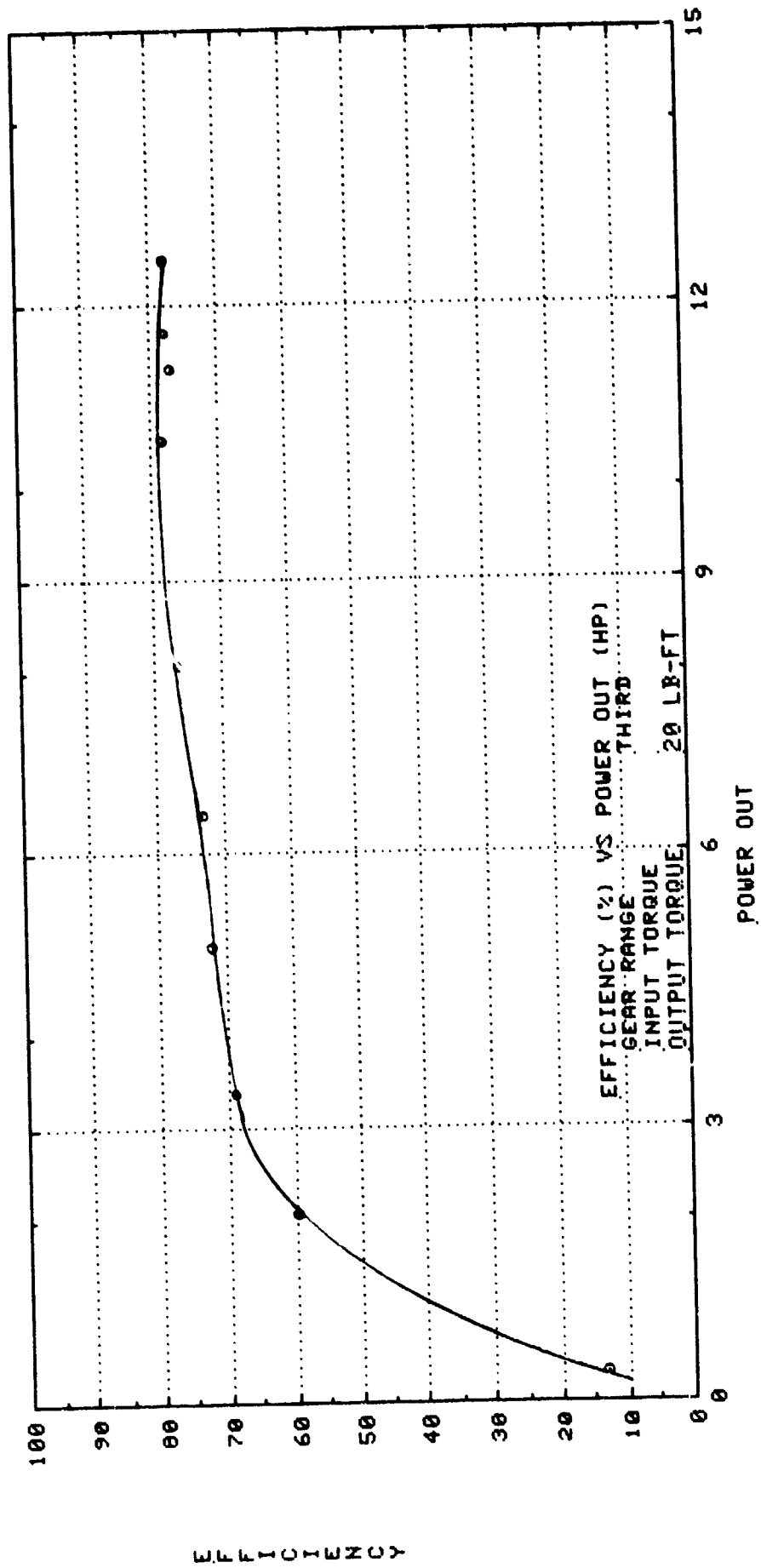

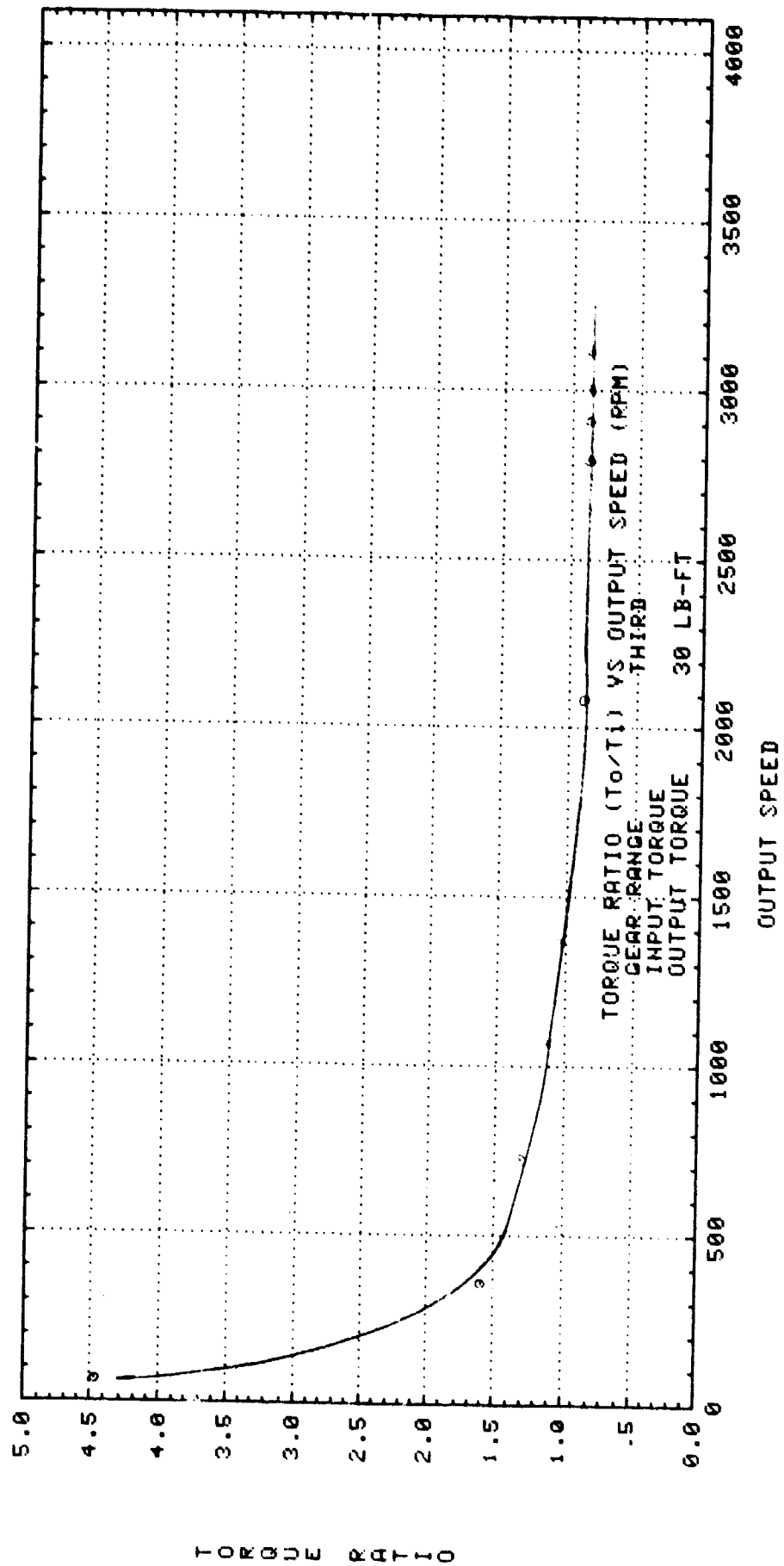

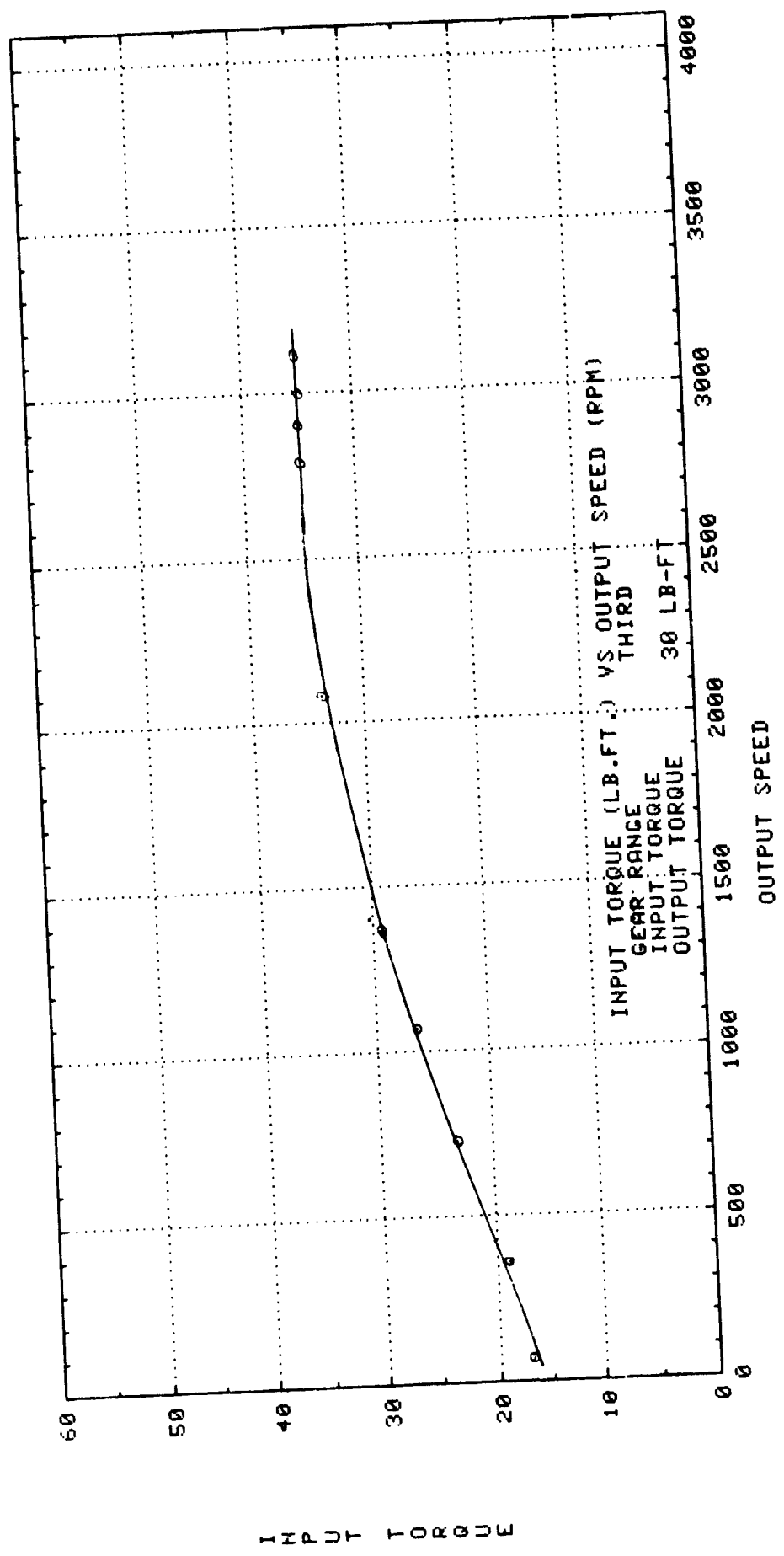



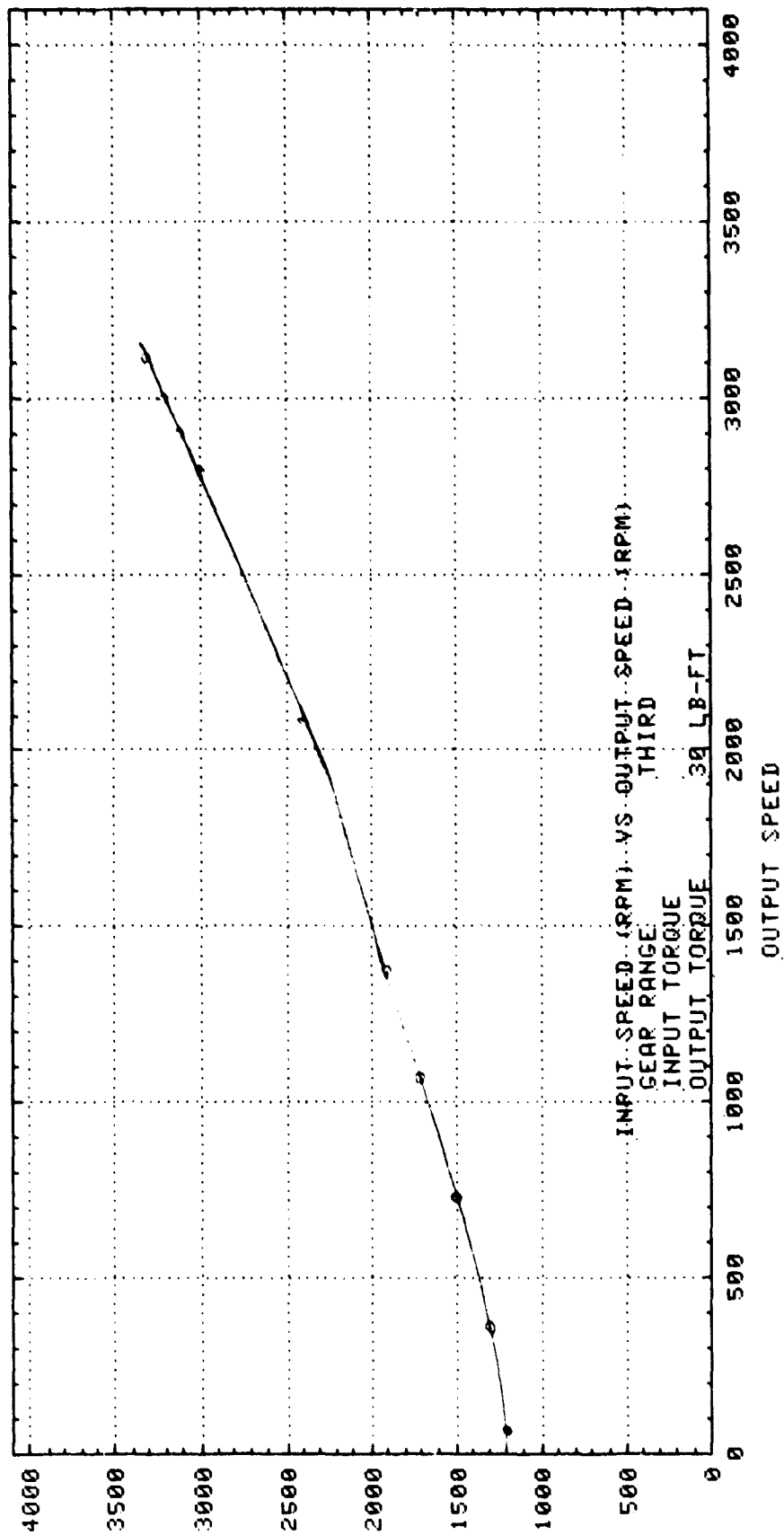

INPUT SPEED

EFFICIENCY

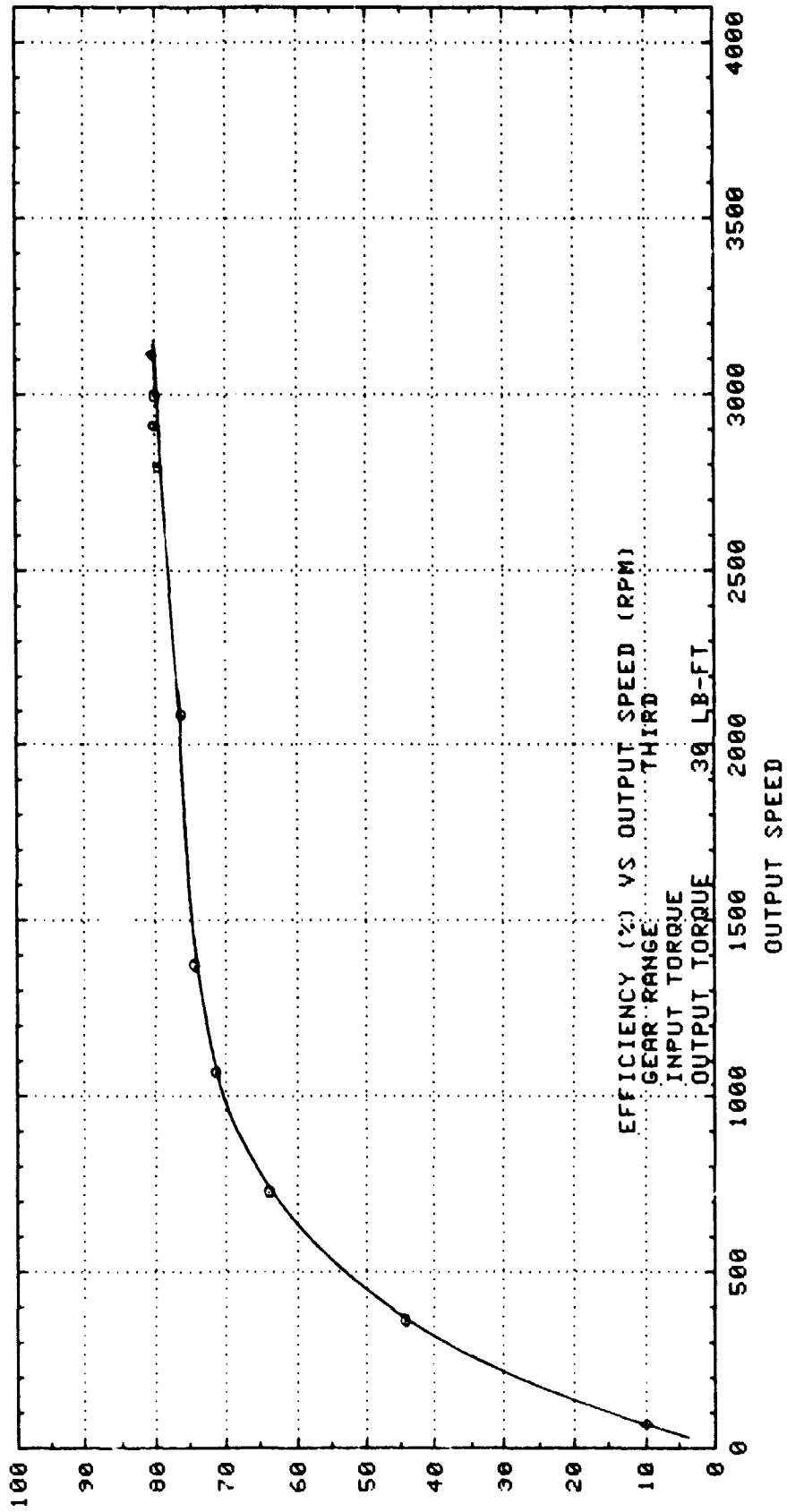

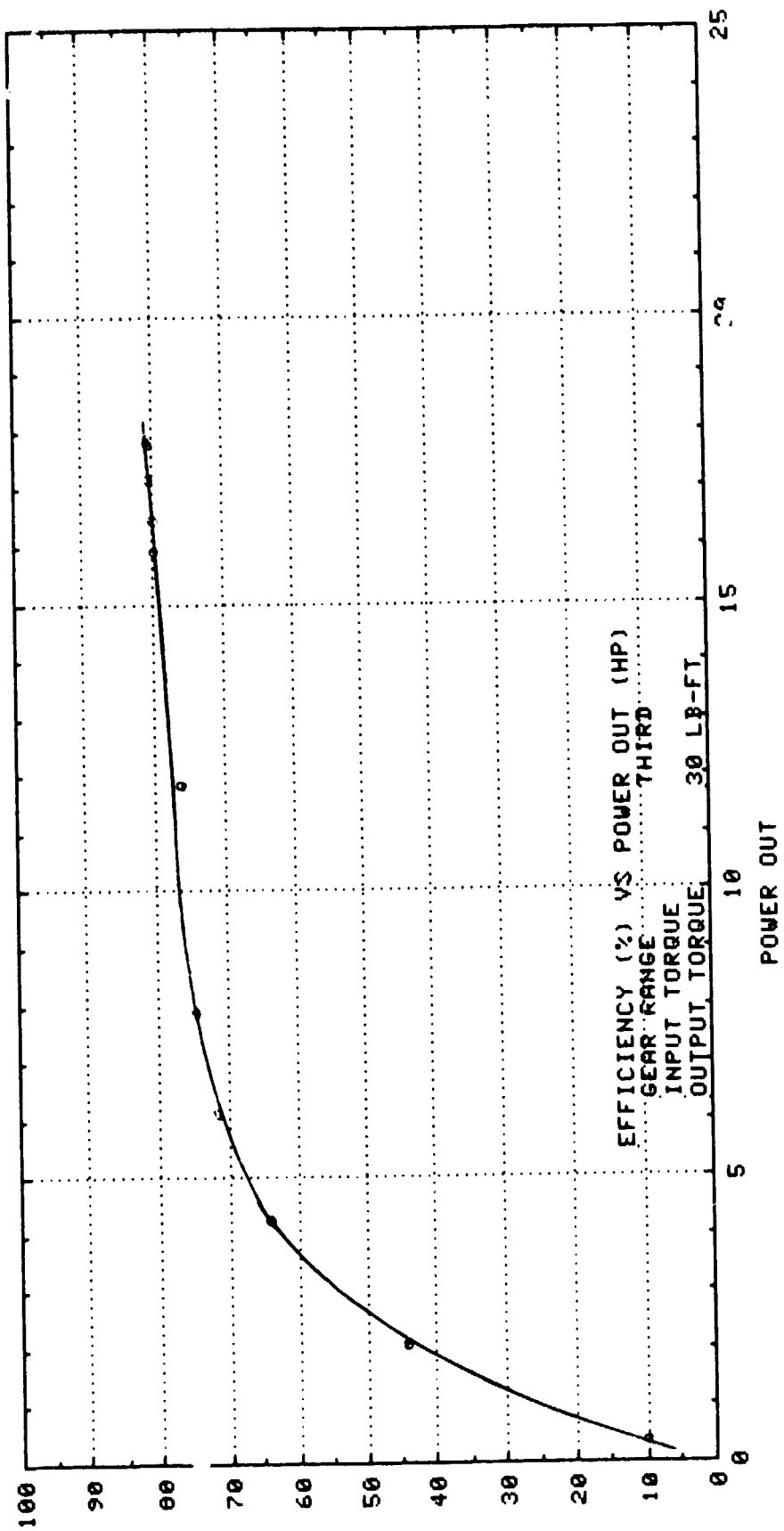

EFFICIENCY

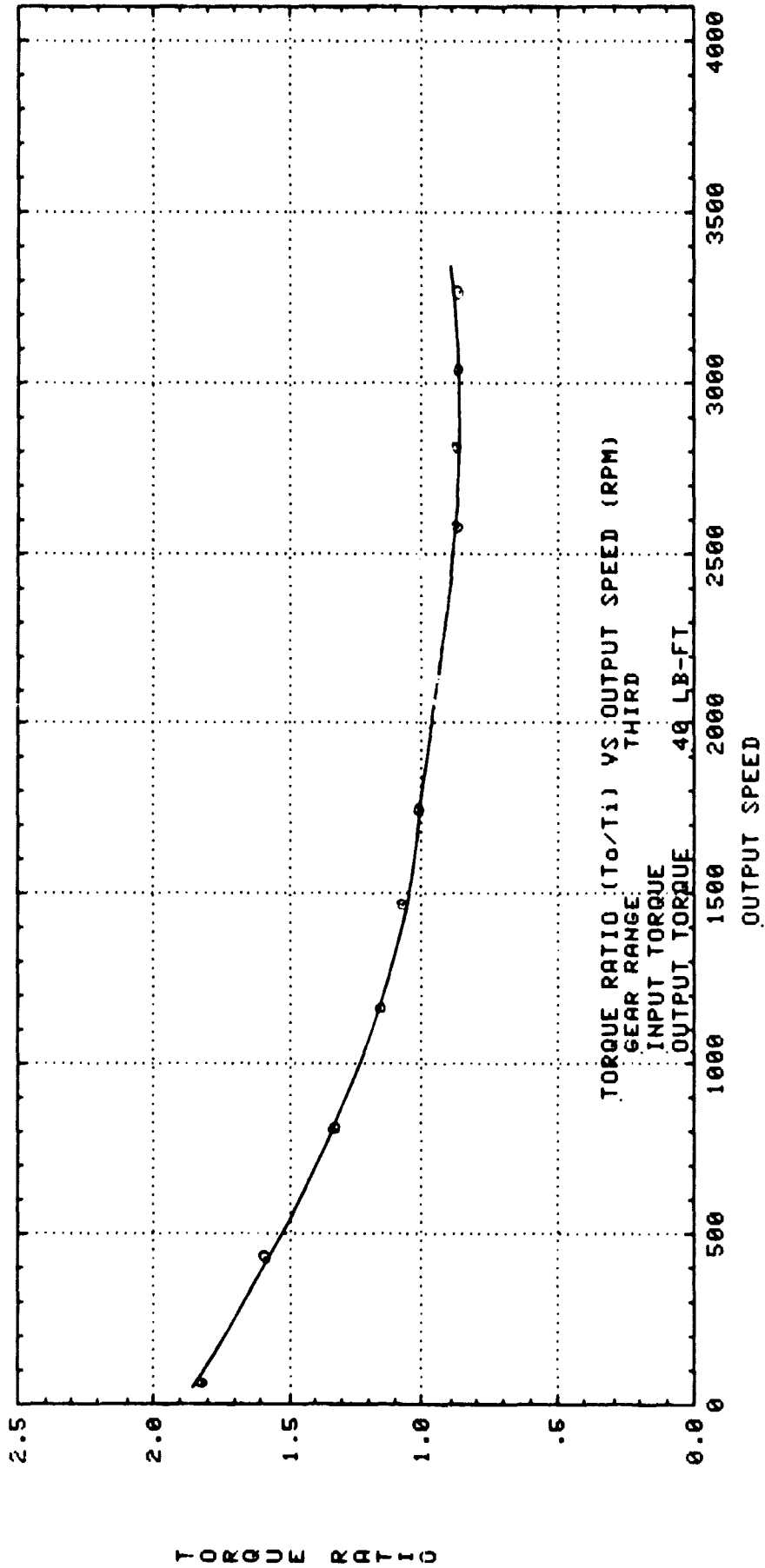

TORQUE RATIO

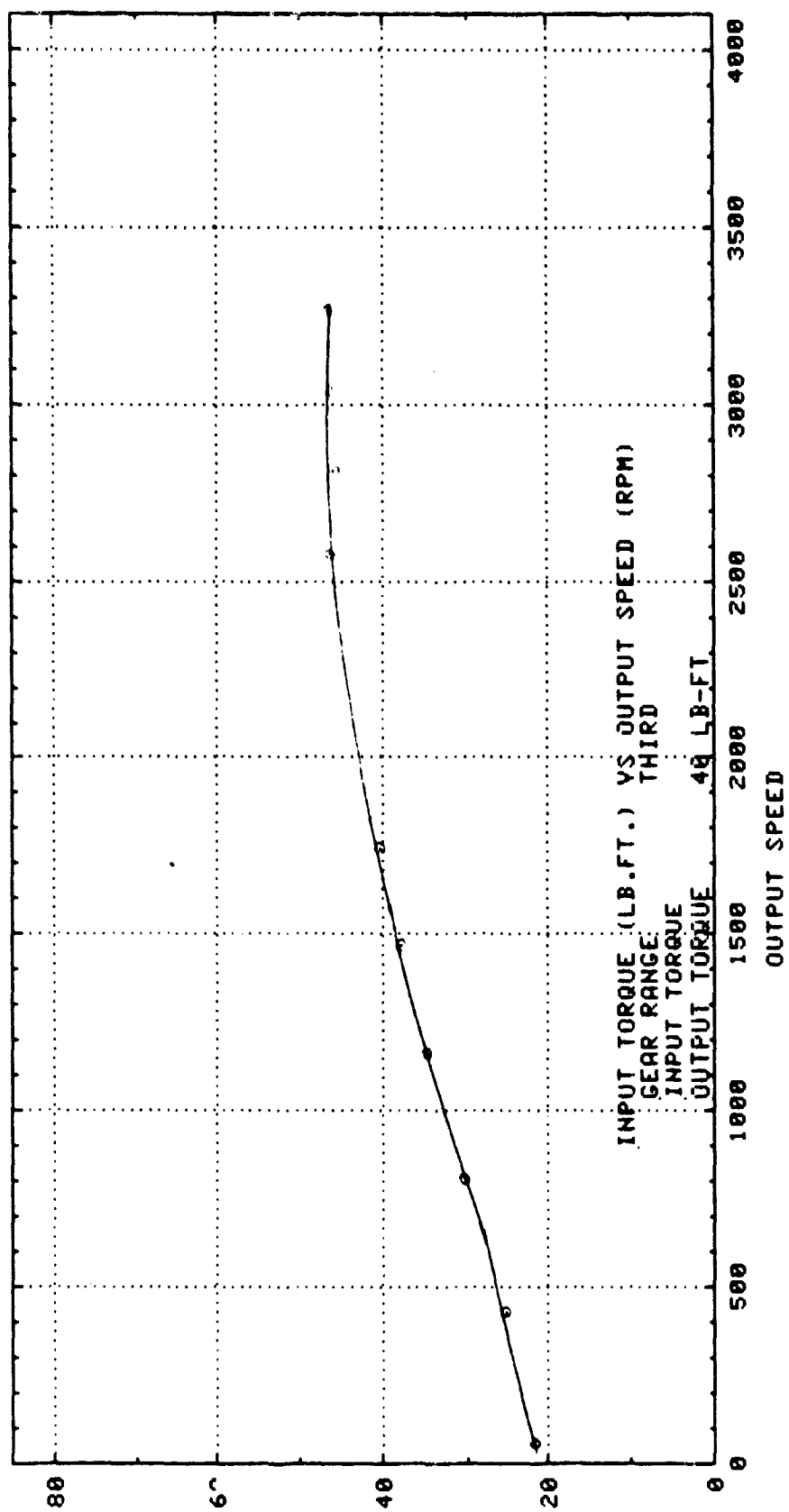

INPUT TORQUE

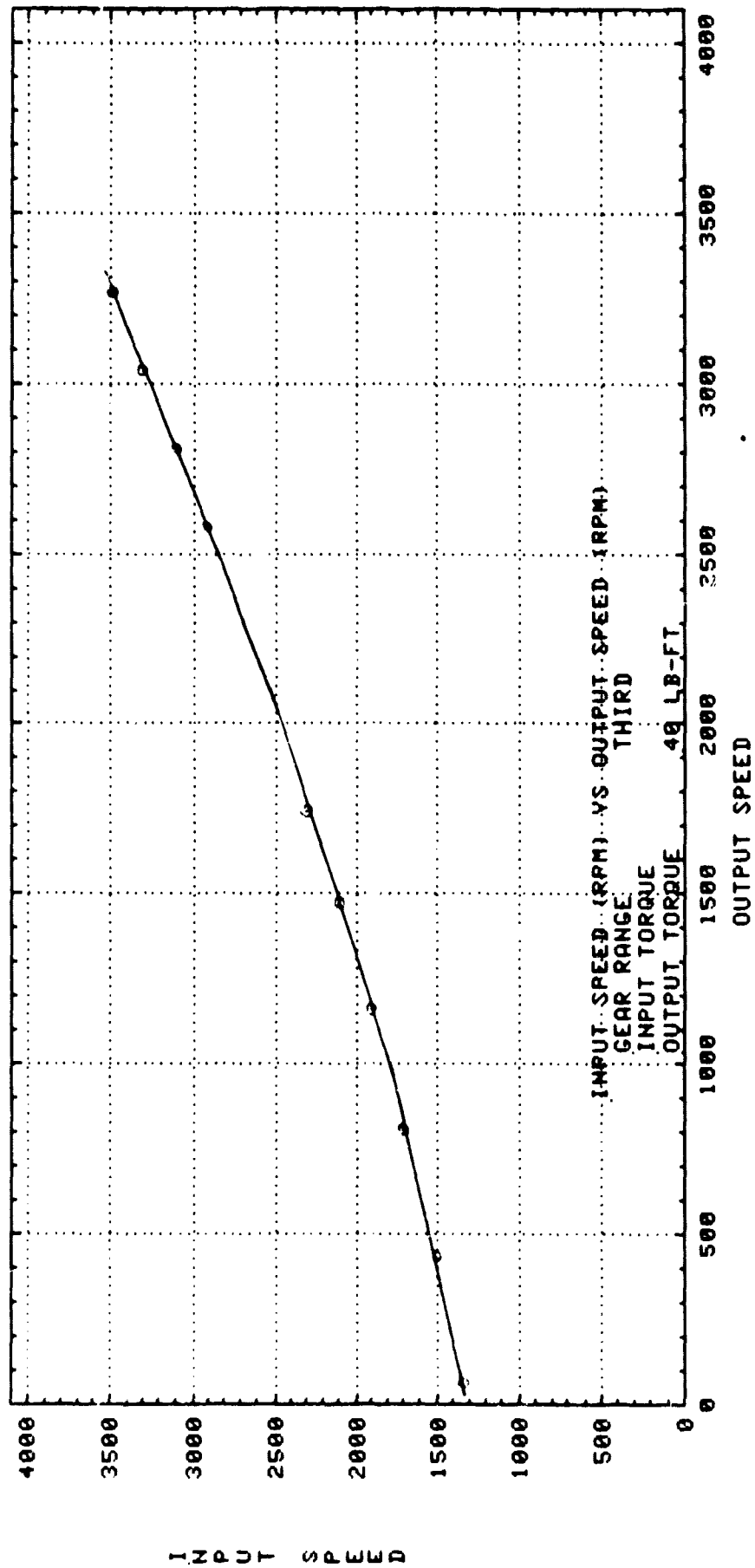

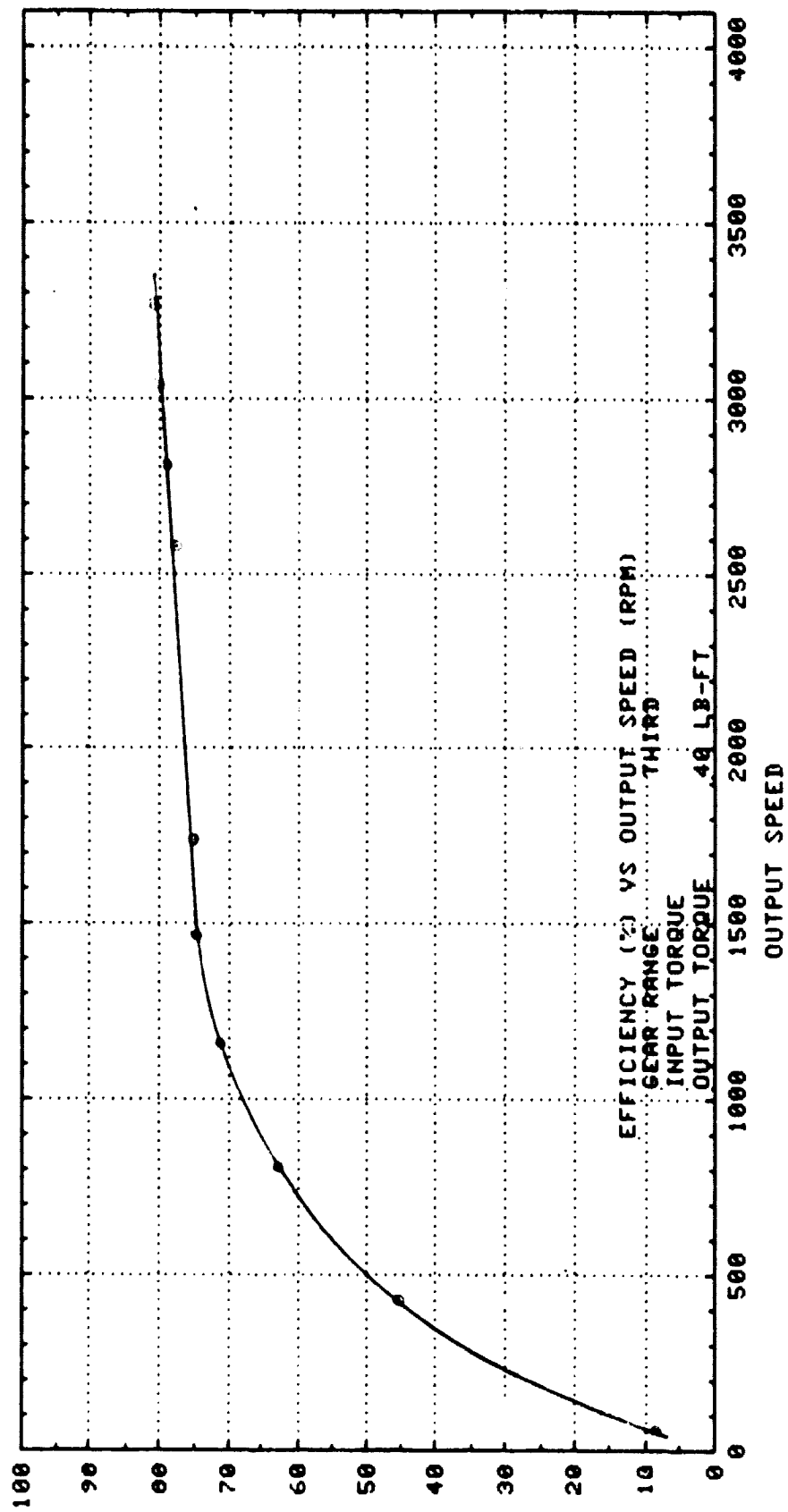

EFFICIENCY

EFFICIENCY

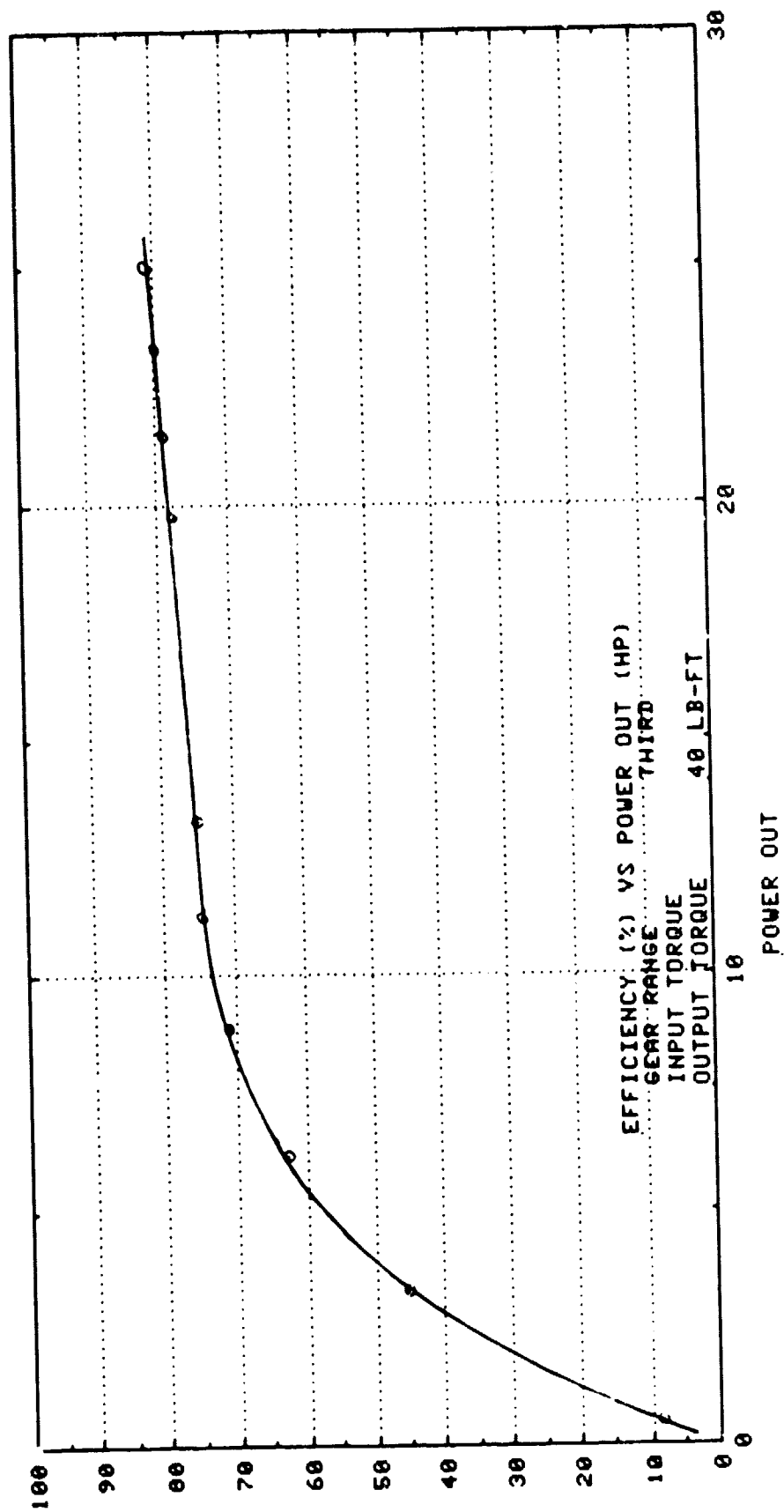



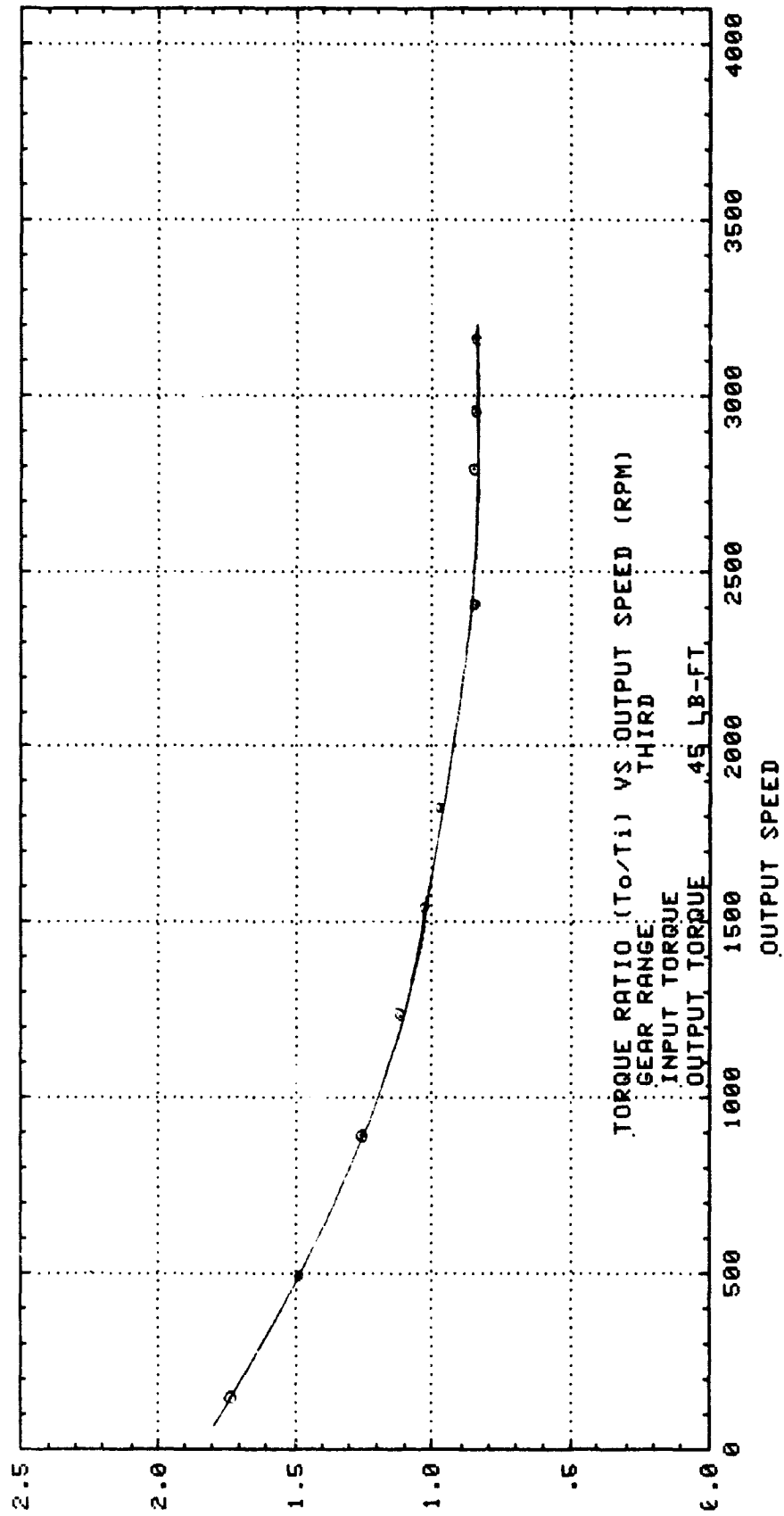

TORQUE RATIO

INPUT TORQUE

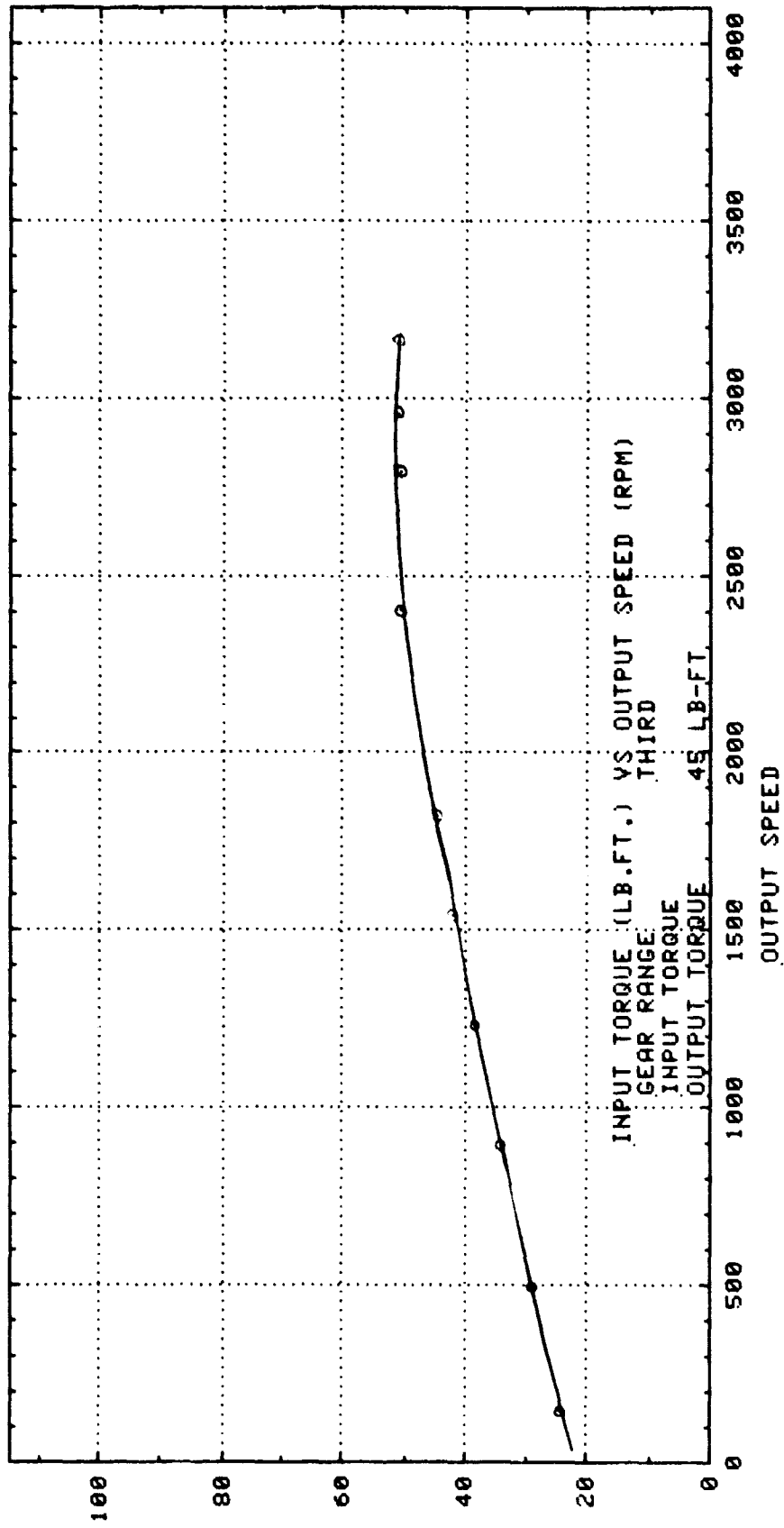

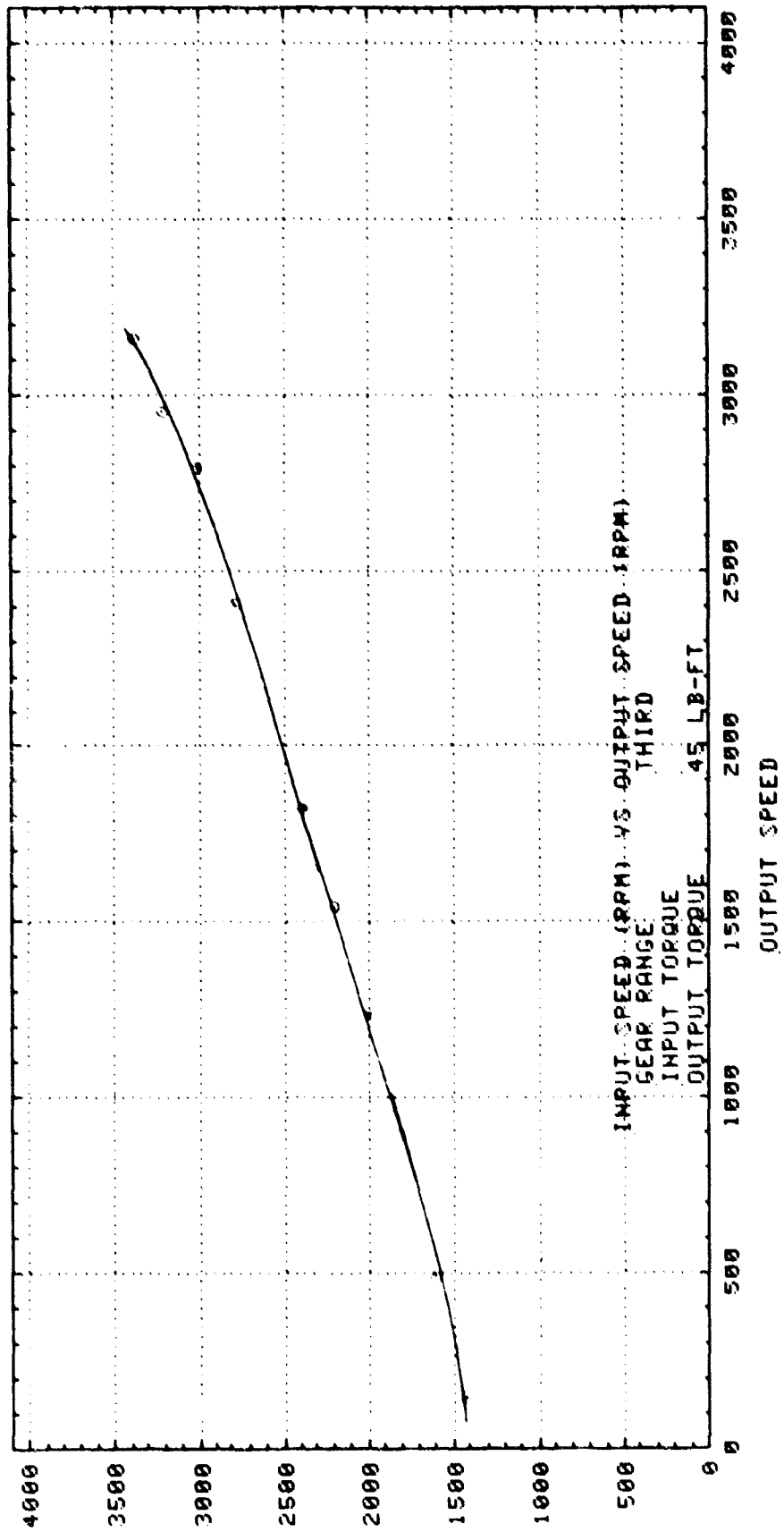

INPUT SPEED

EFFICIENCY

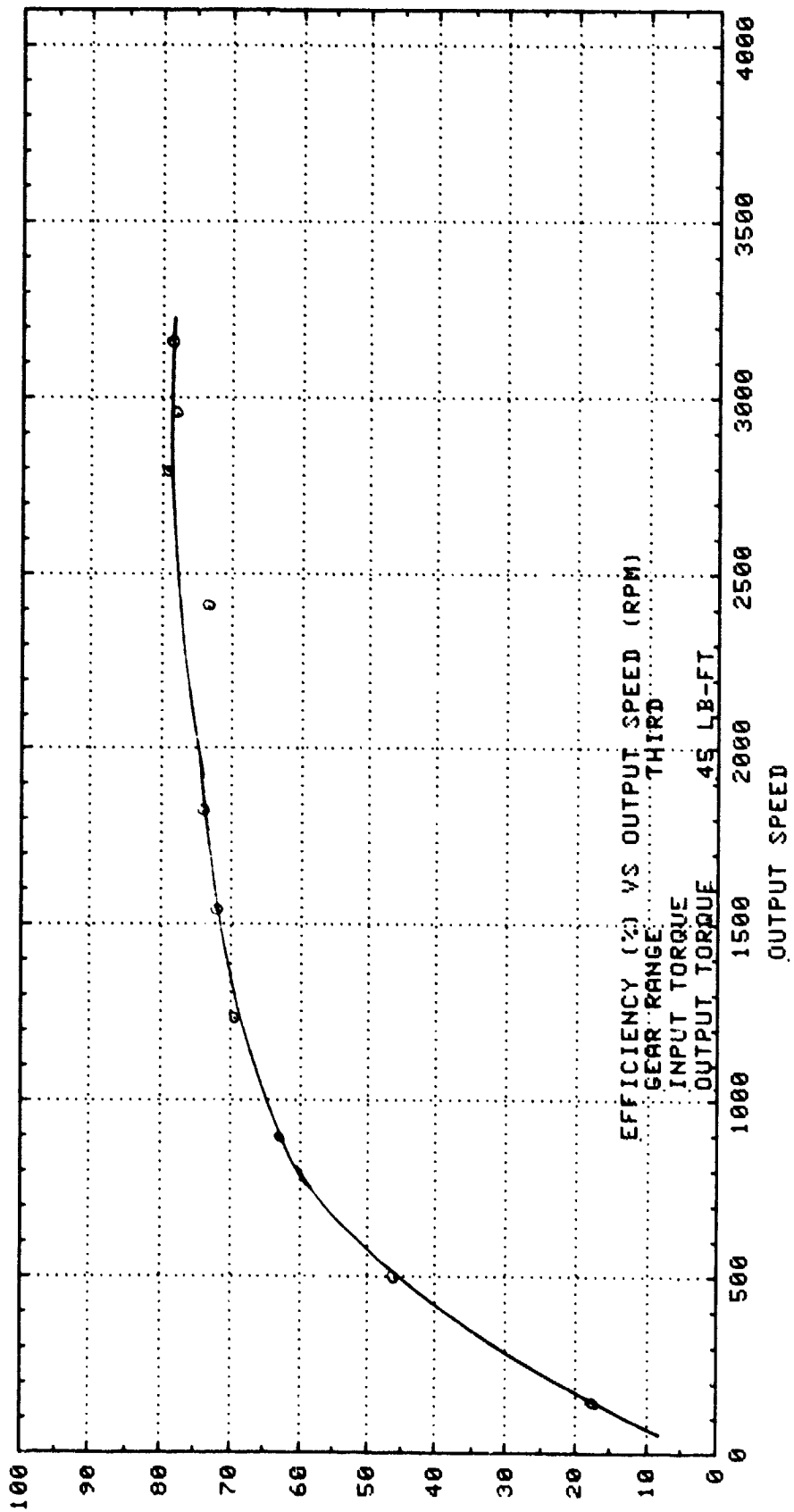

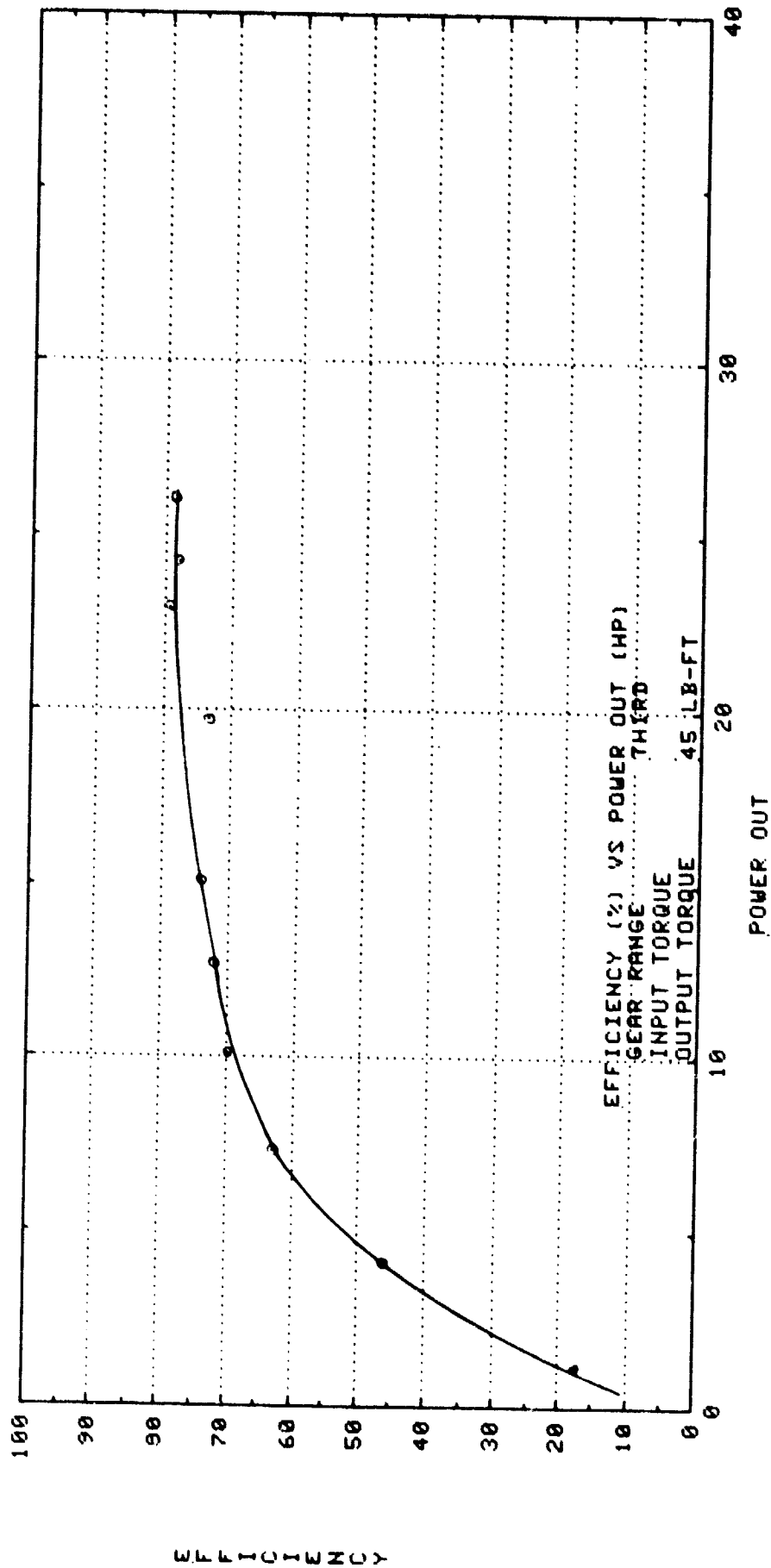

EFFICIENCY

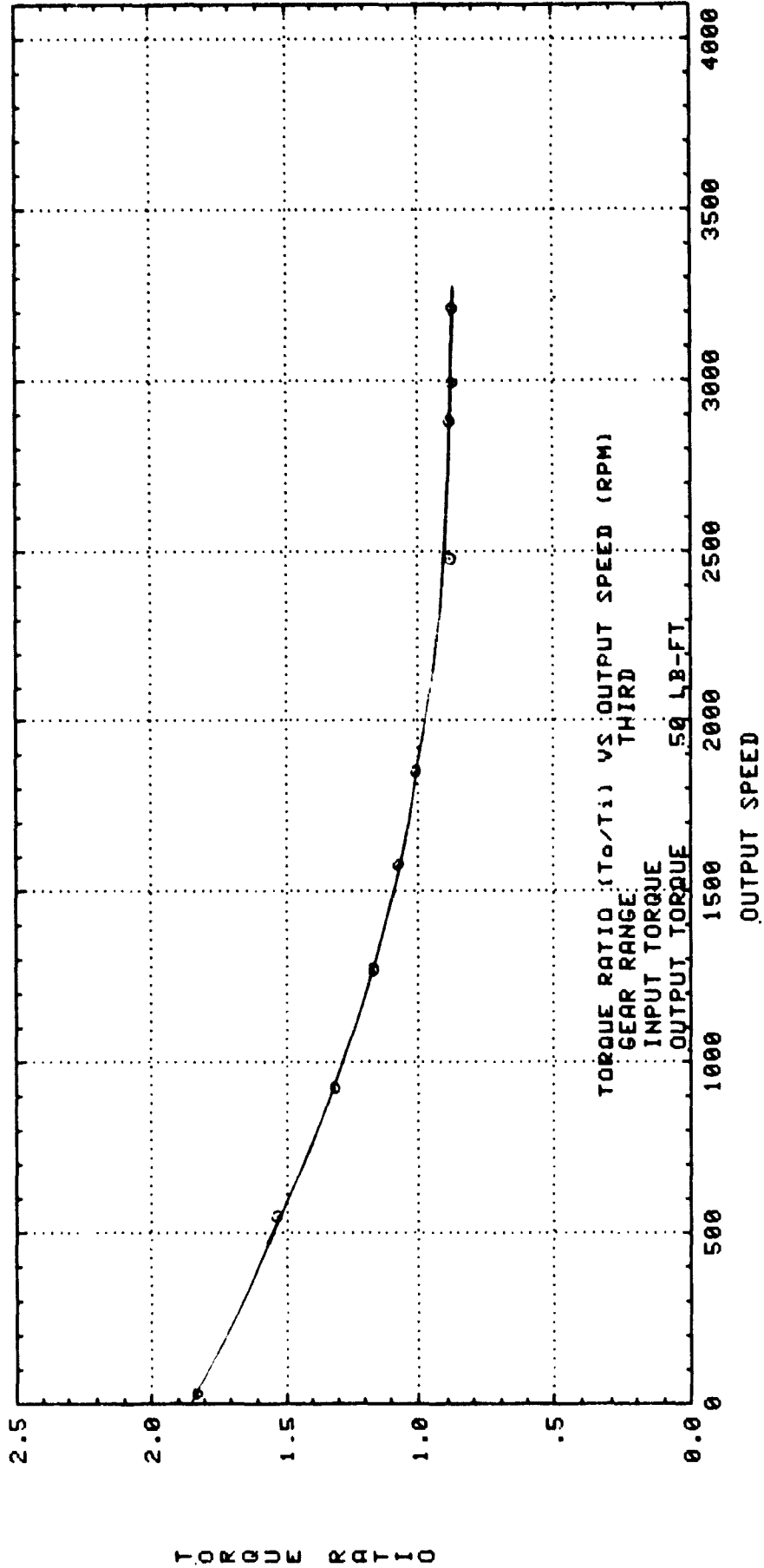

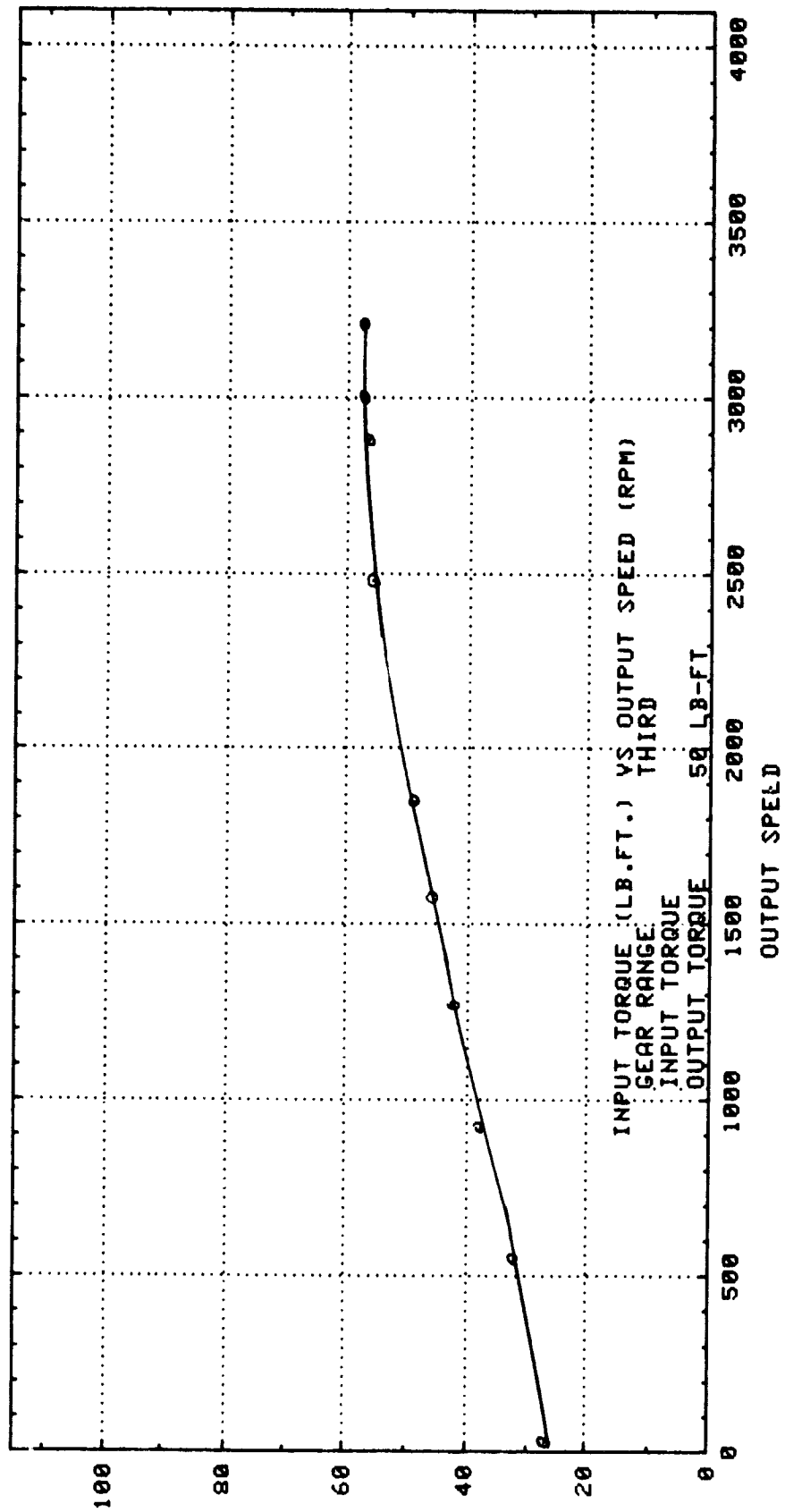

INPUT TORQUE

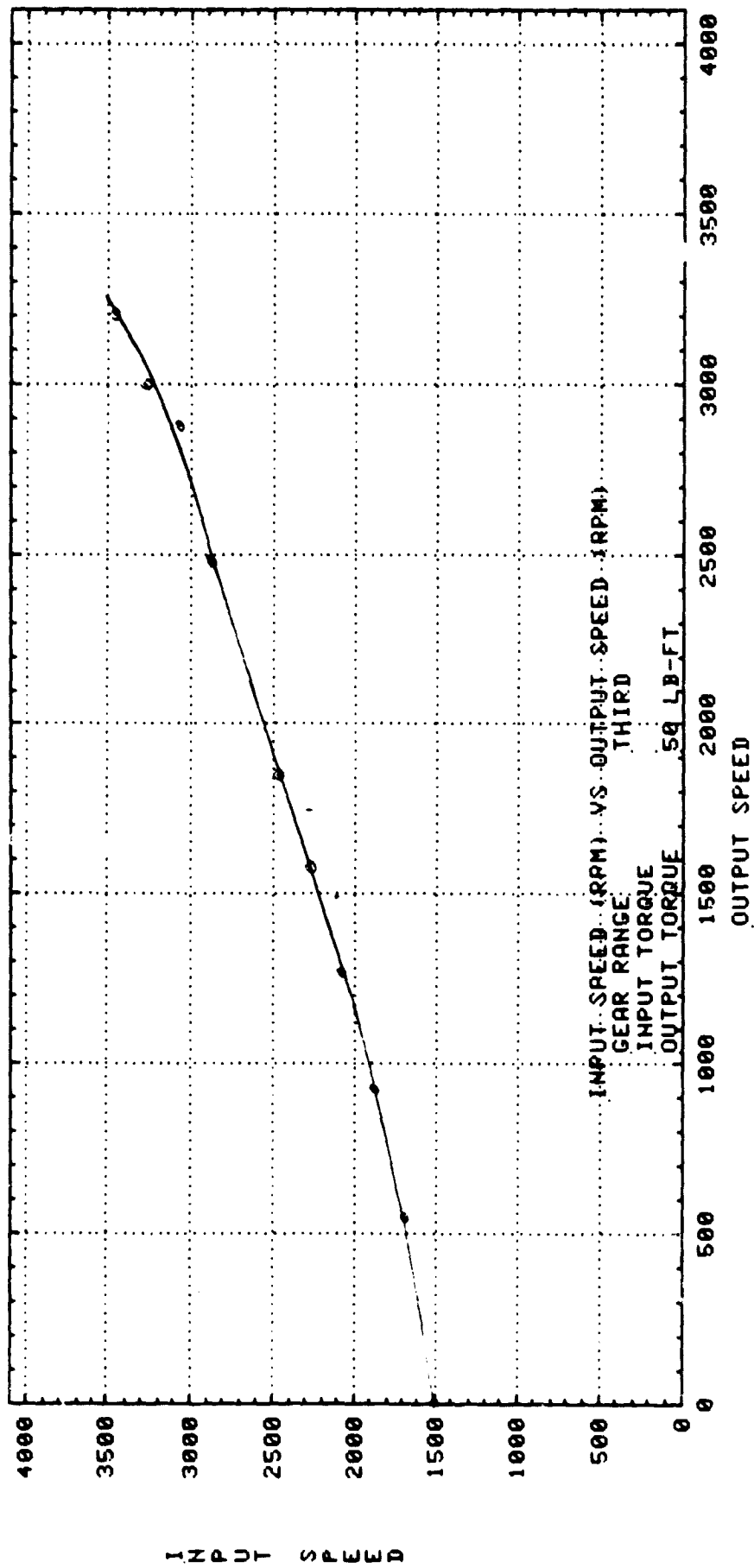



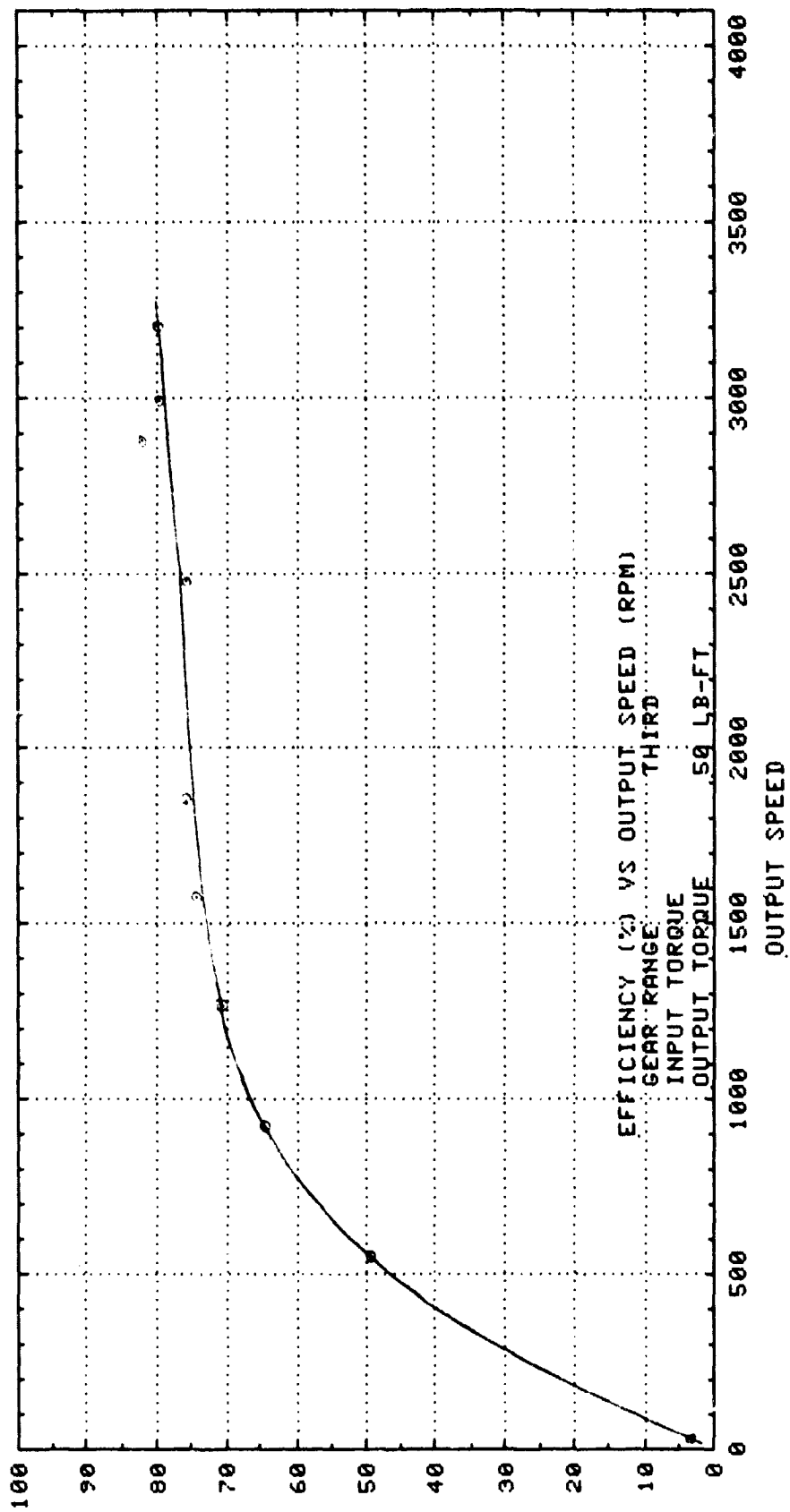

EFFICIENCY

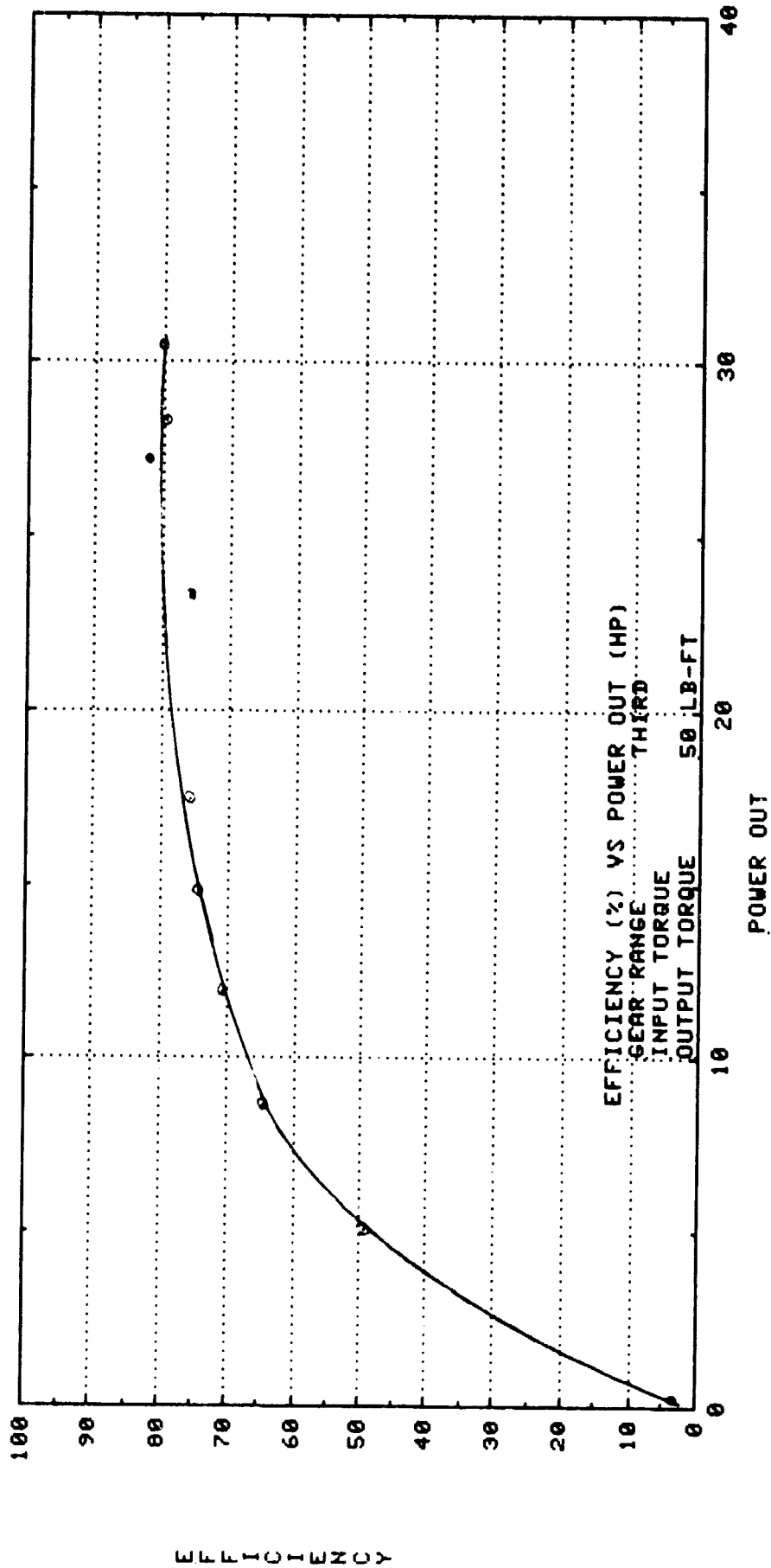

EFFICIENCY

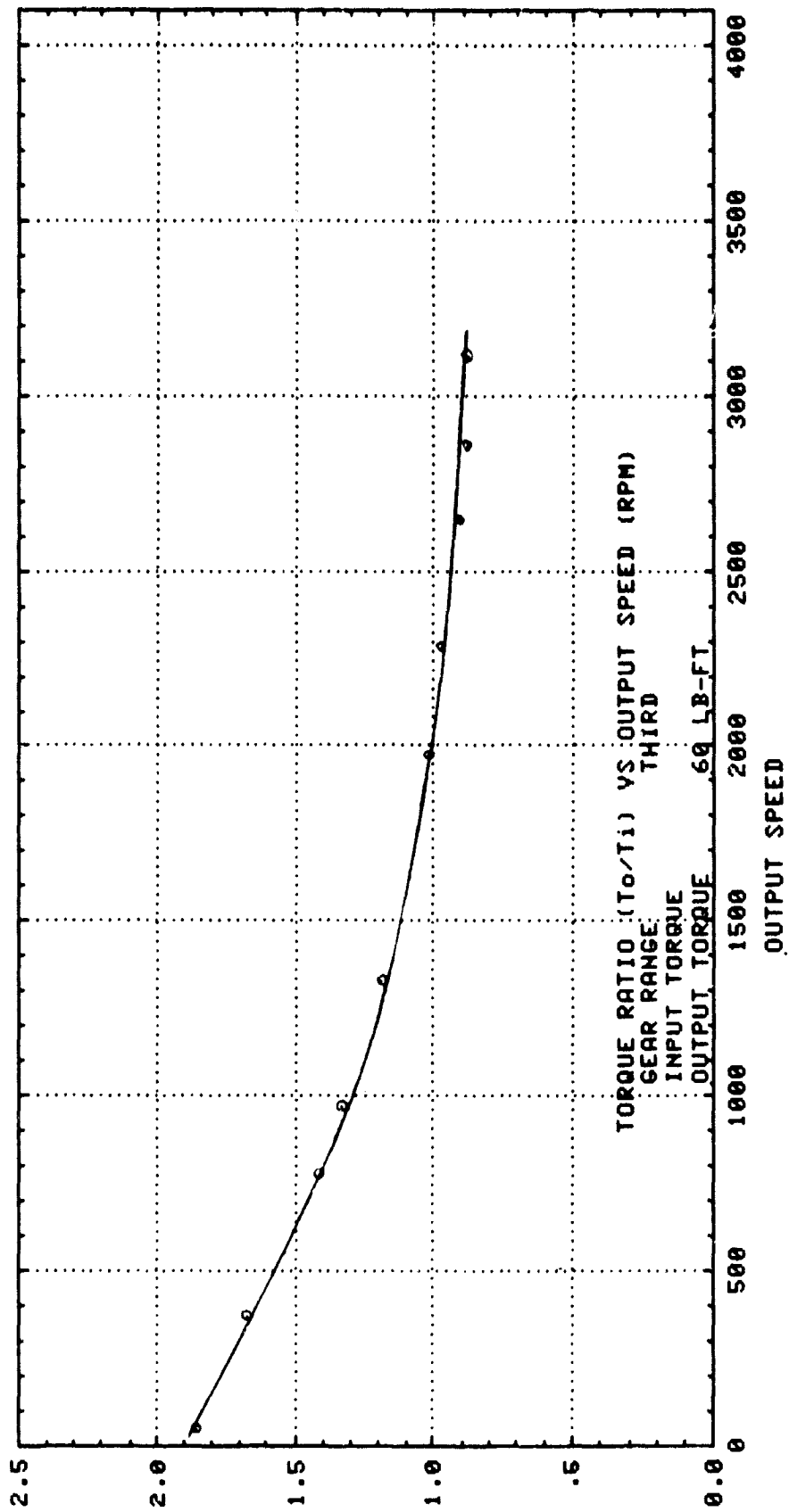

TORQUE RATIO

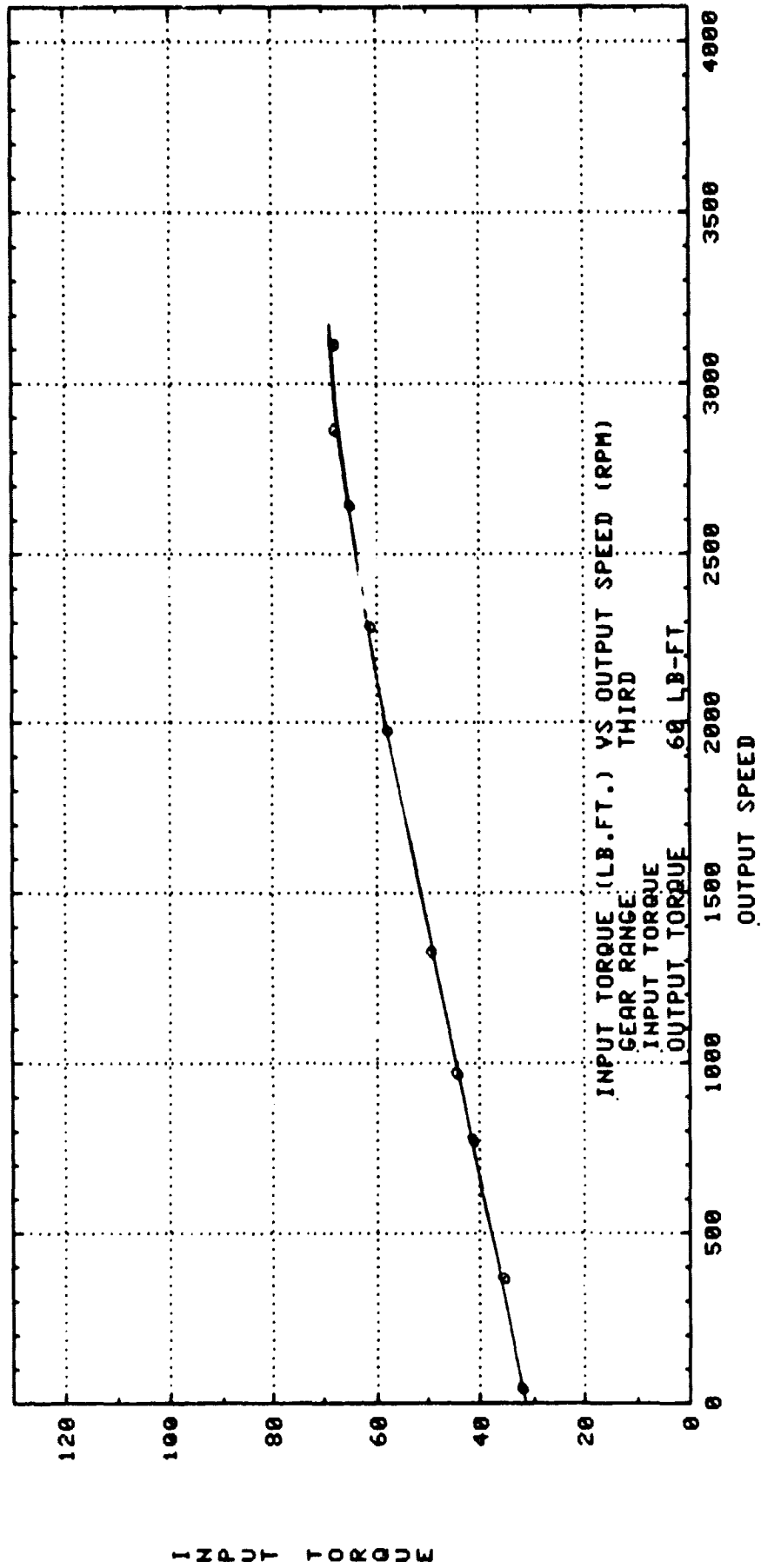

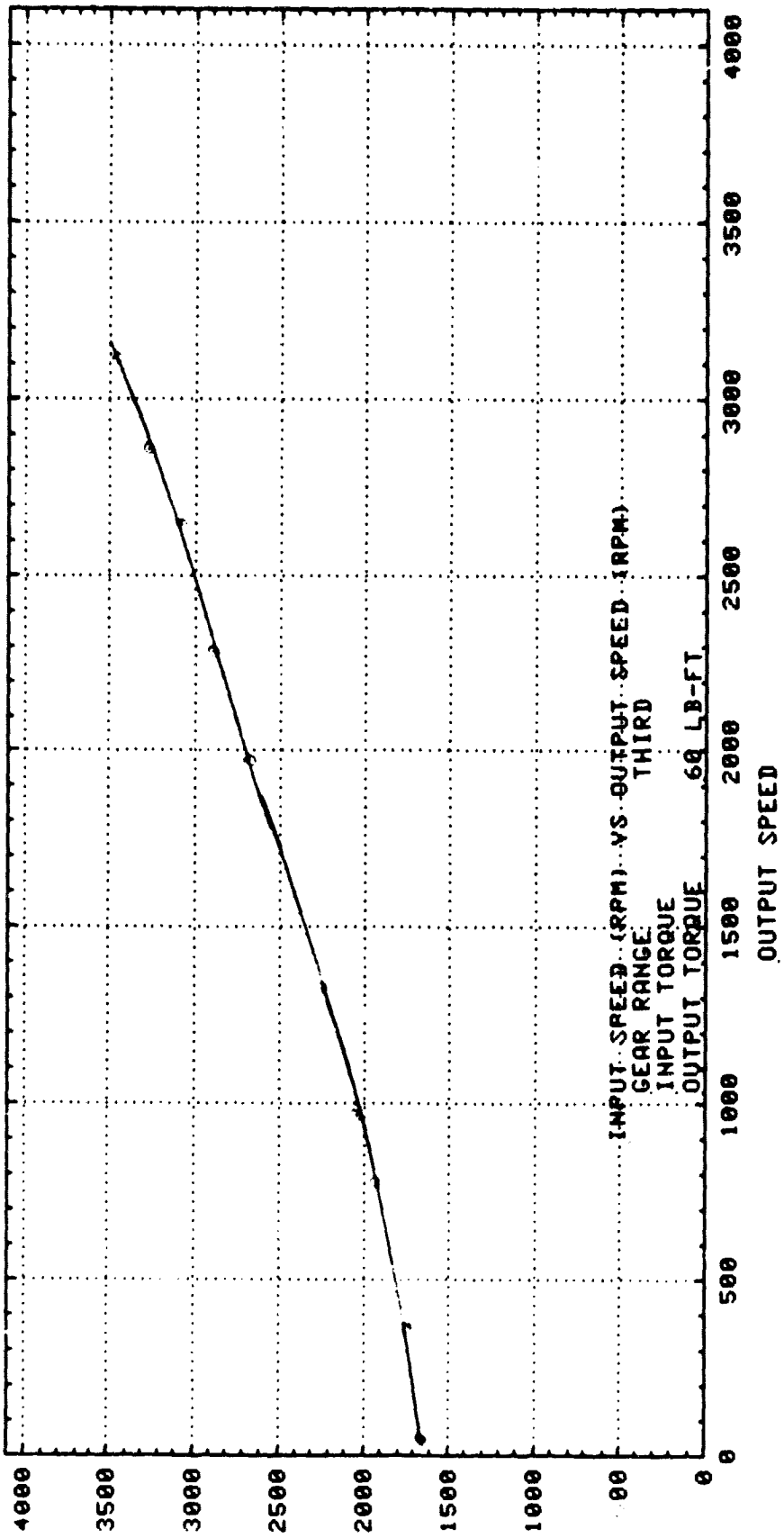

INPUT SPEED

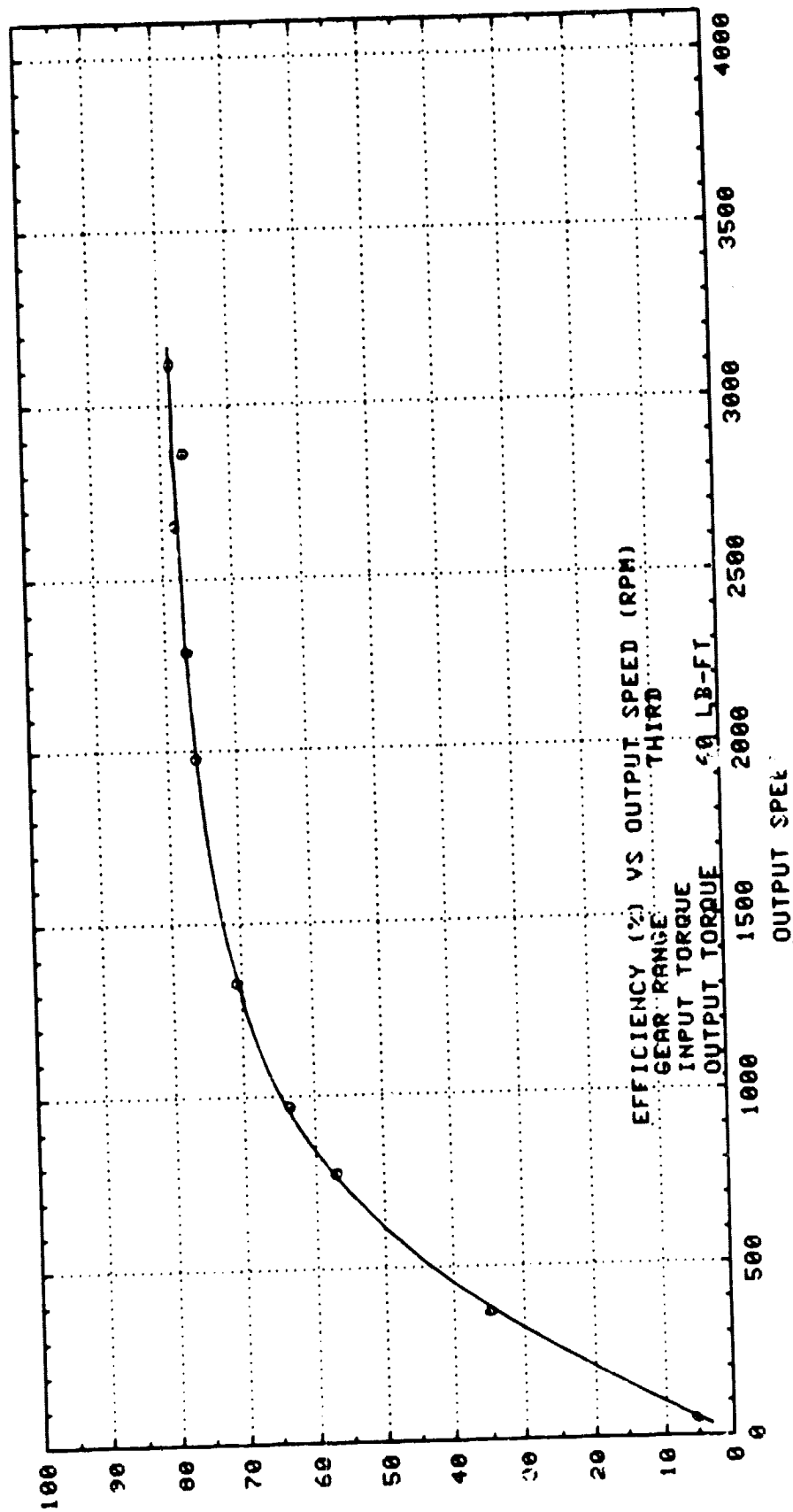

EFFICIENCY

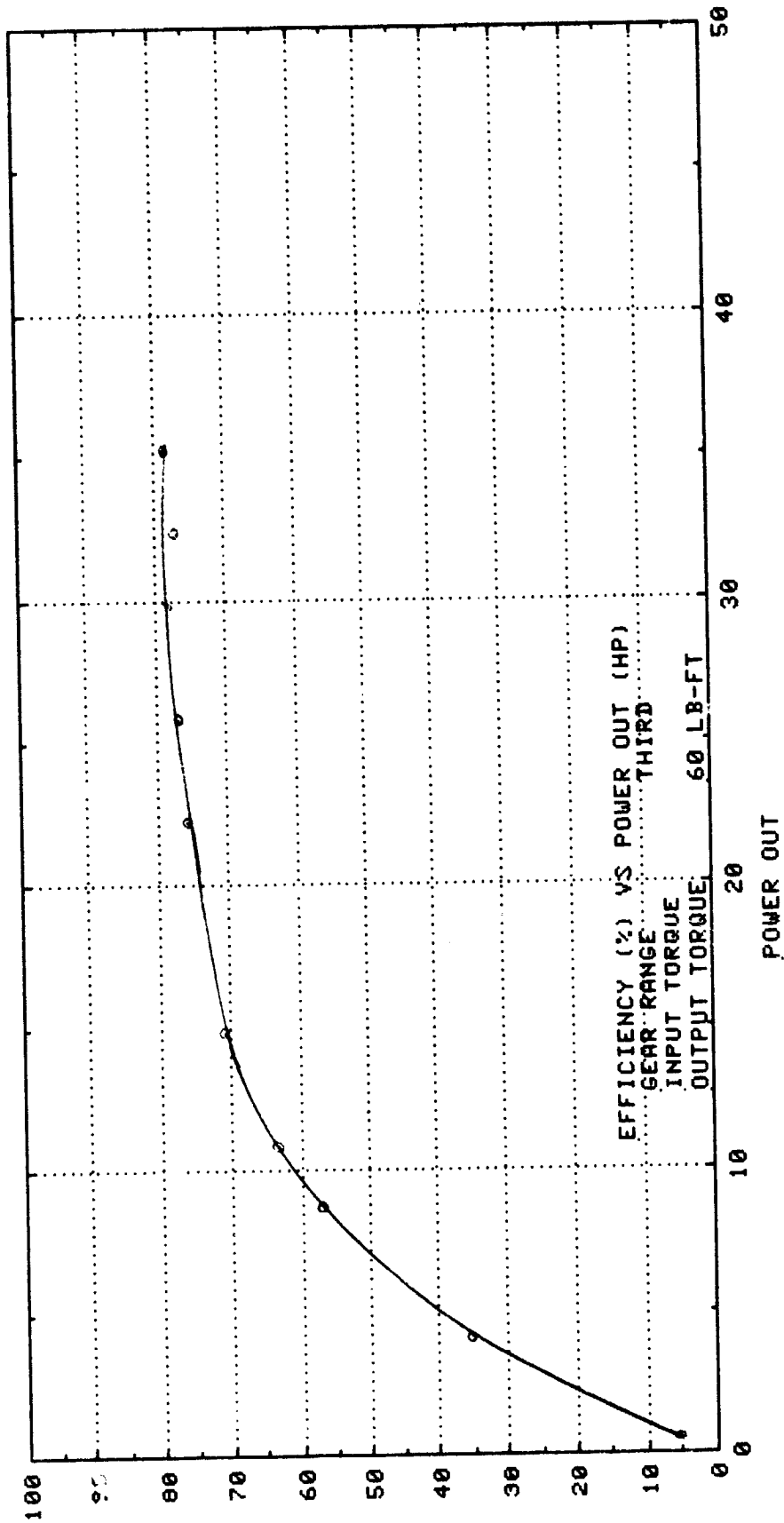

EFFICIENCY

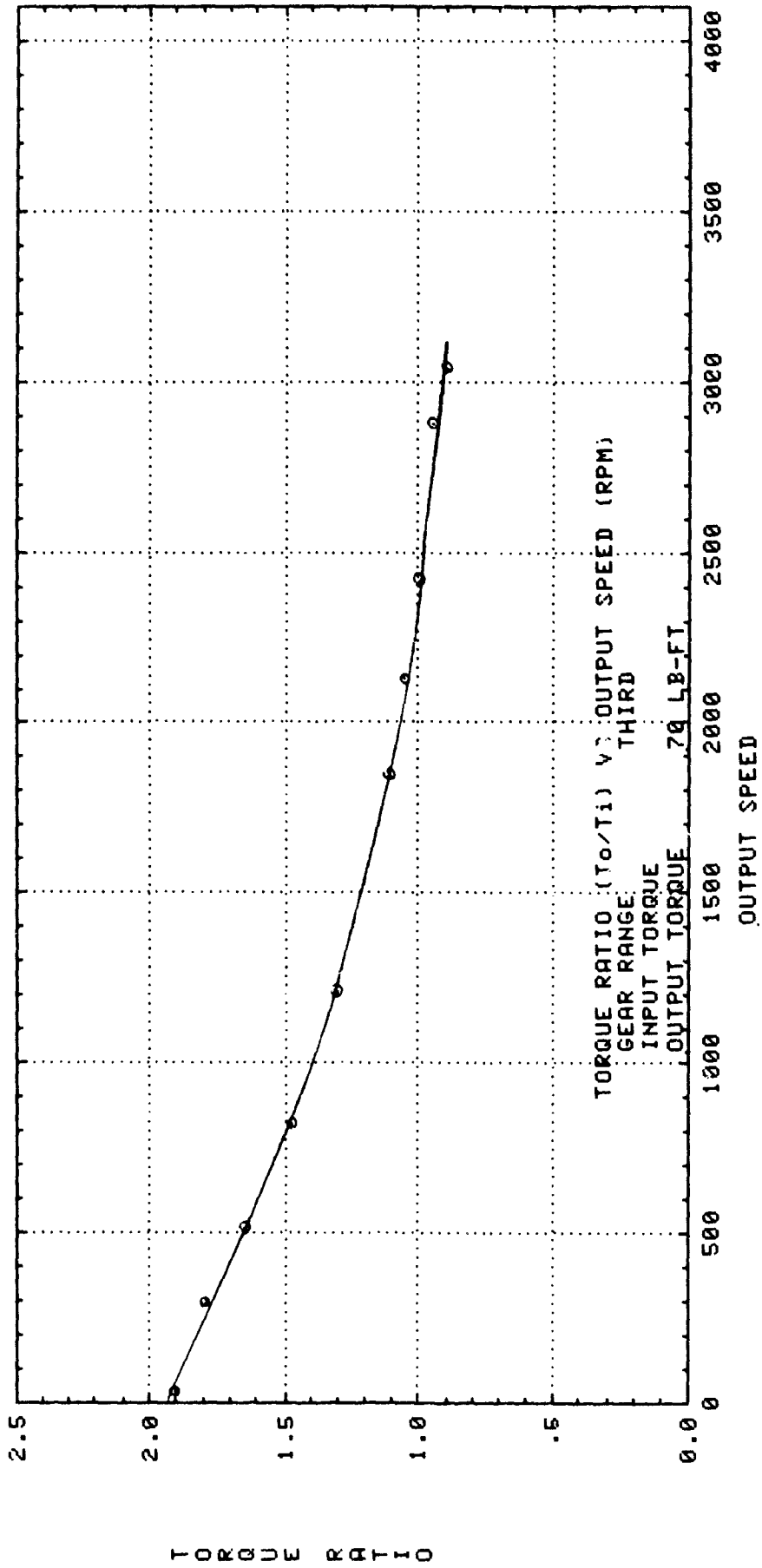



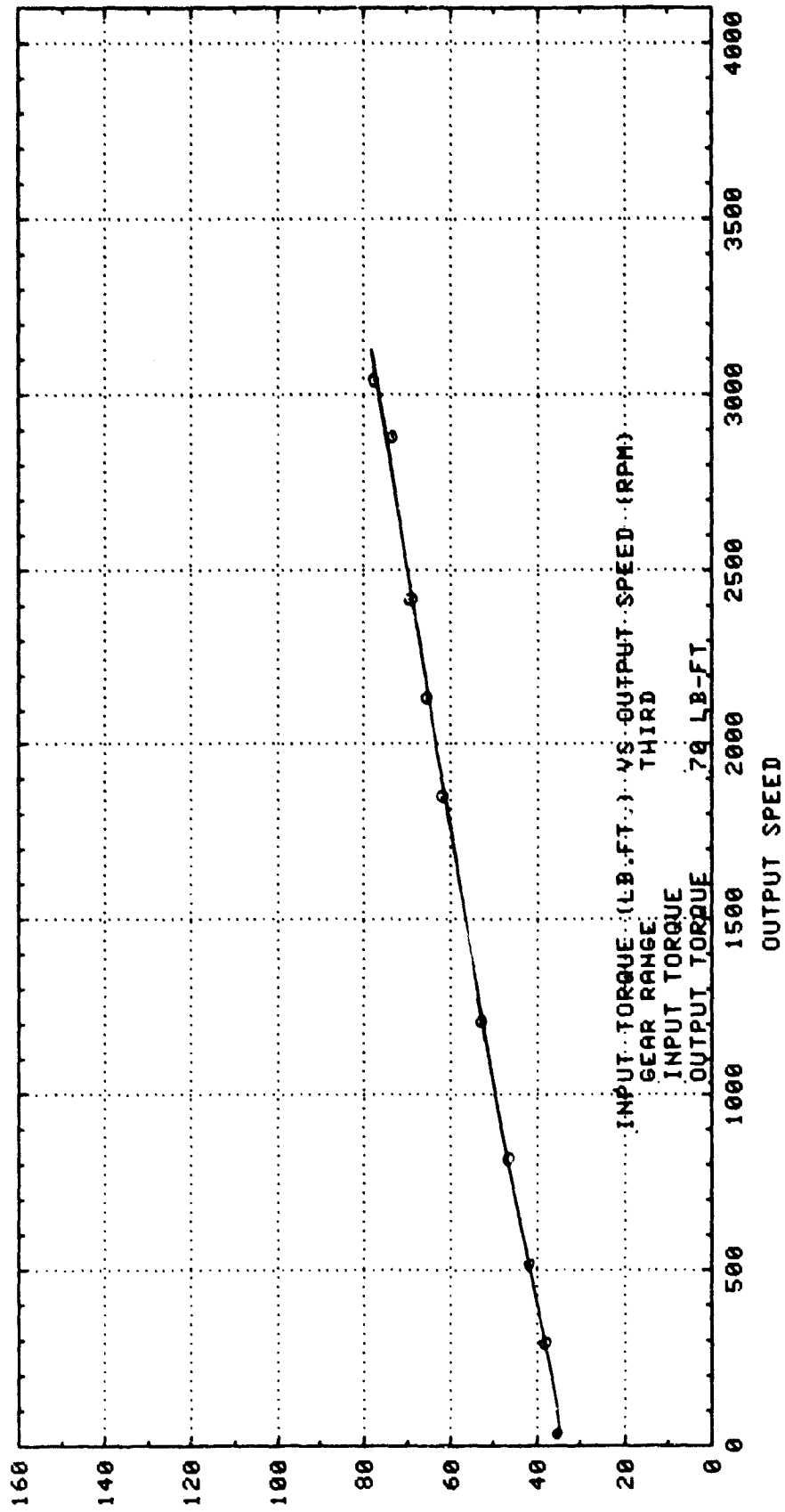

INPUT TORQUE

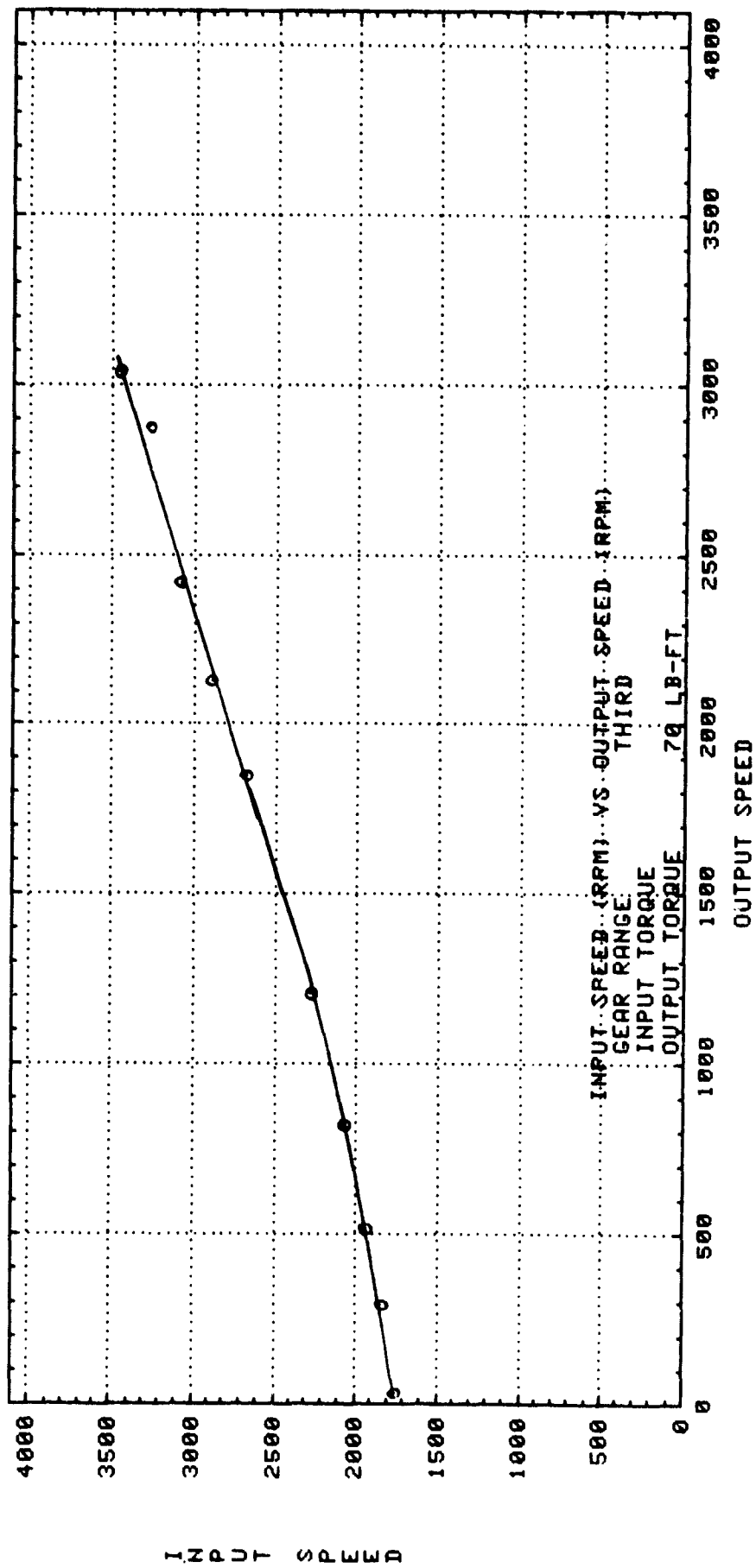

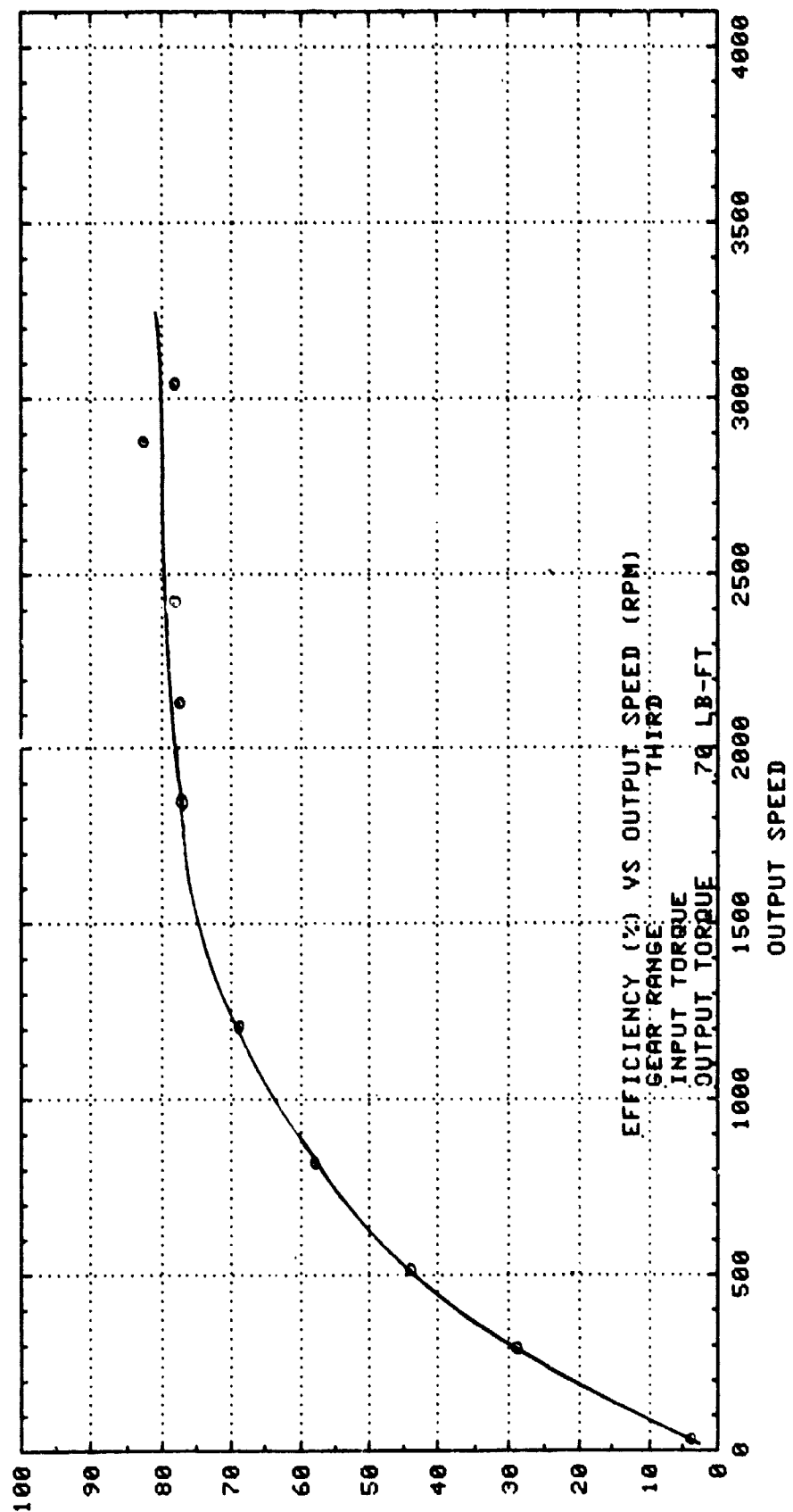

EFFICIENCY

EFFICIENCY

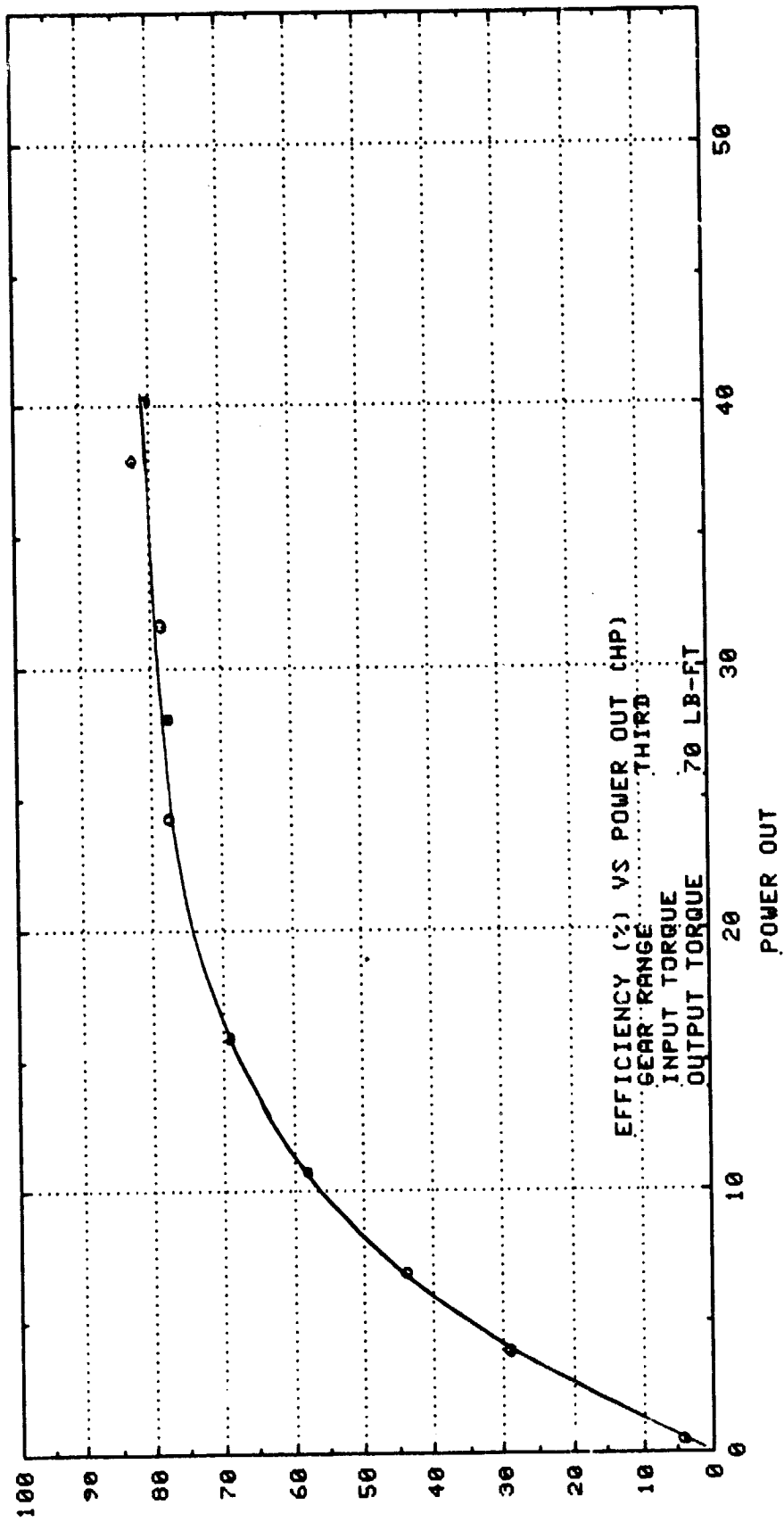

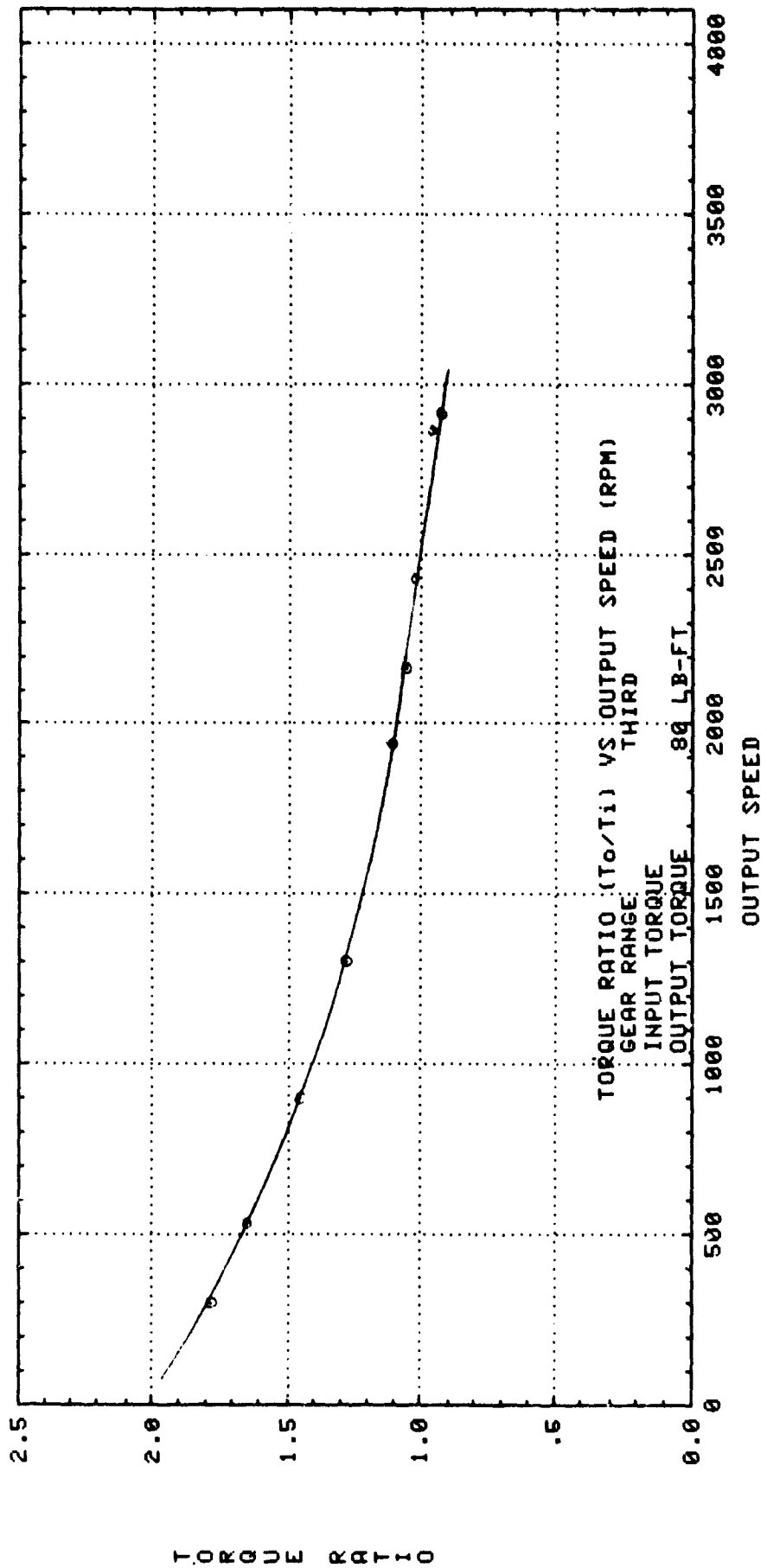

TORQUE RATIO

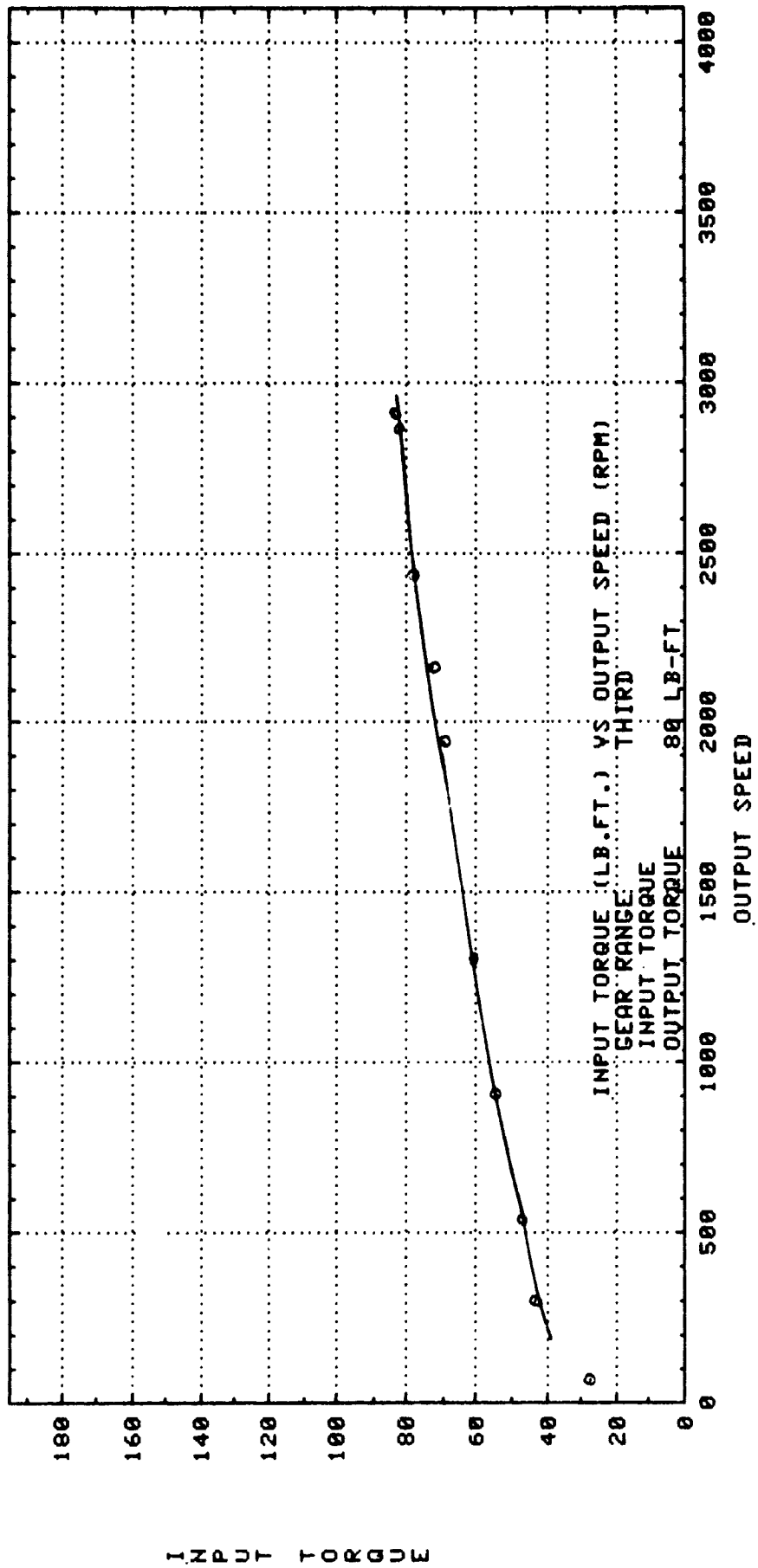

INPUT TORQUE

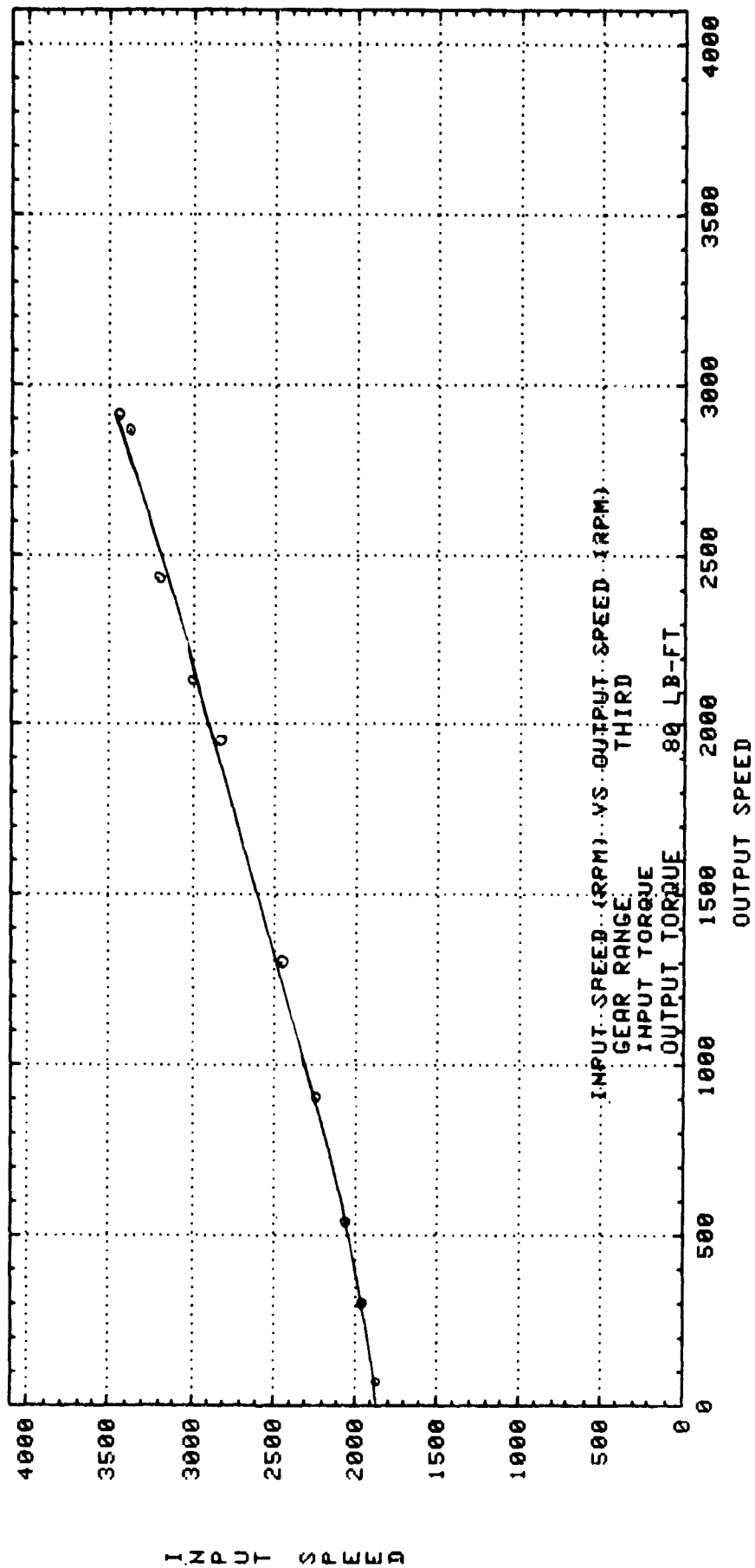

INPUT SPEED

EFFICIENCY

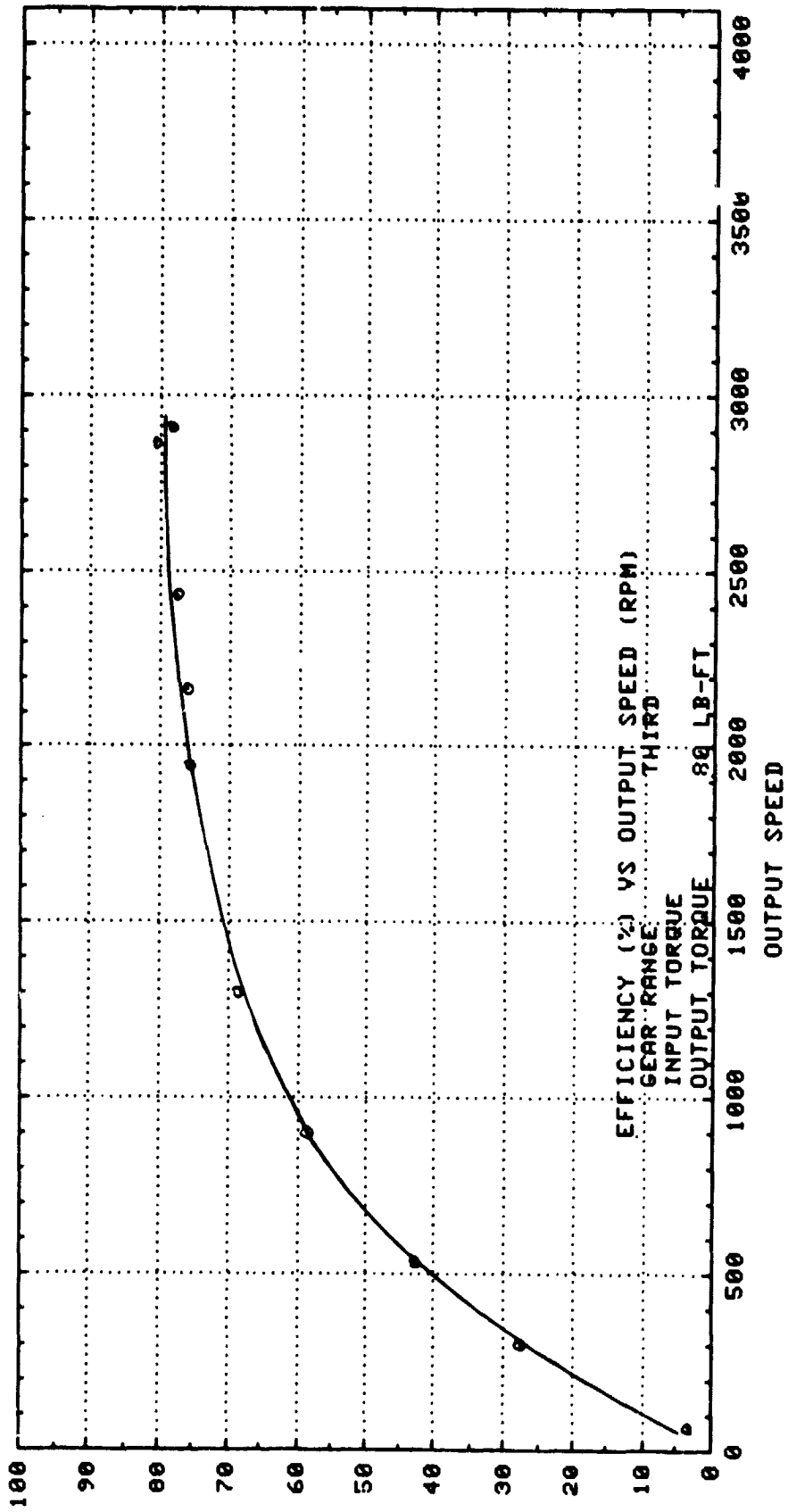



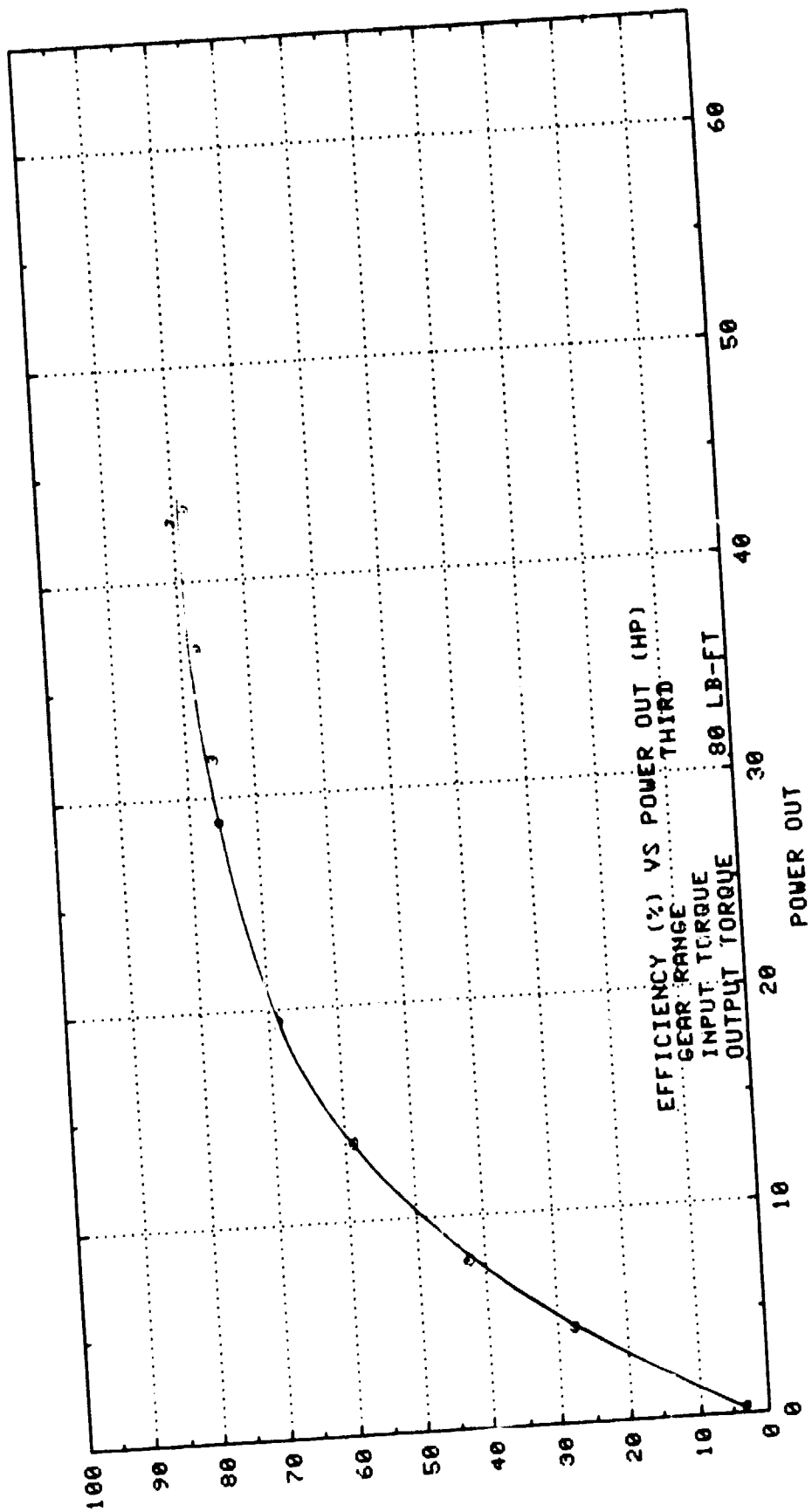

EFFICIENCY

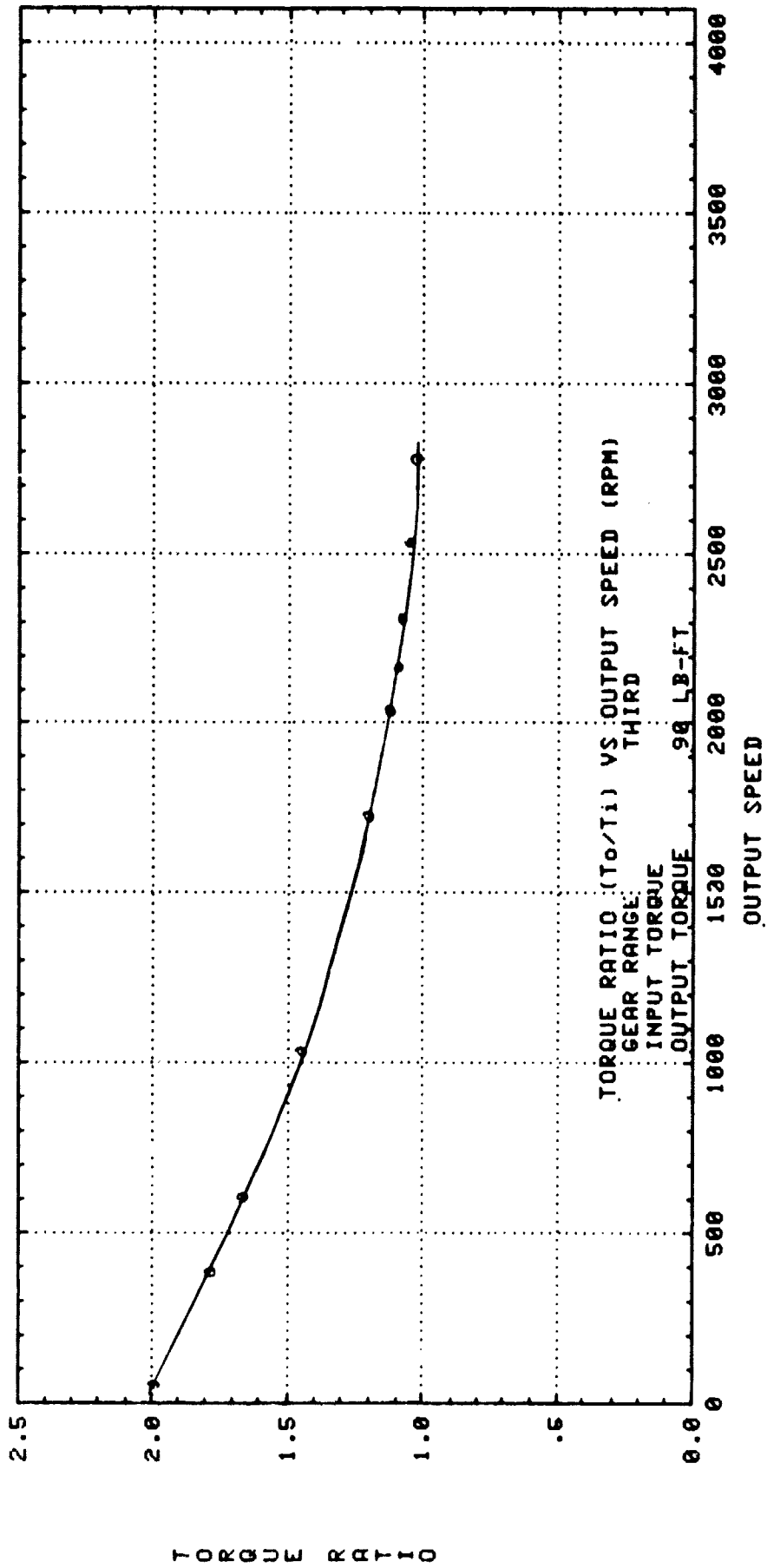

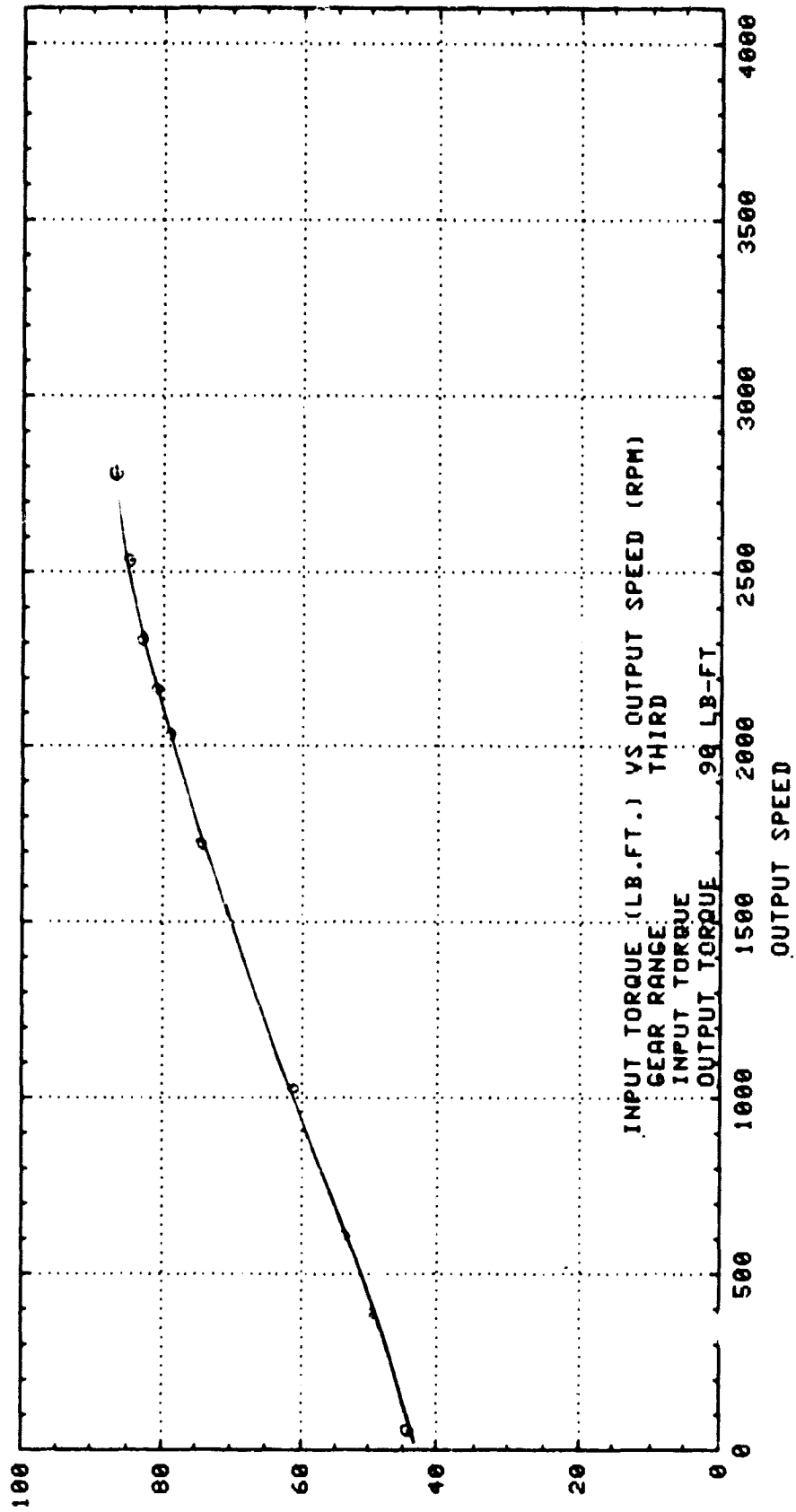

INPUT TORQUE

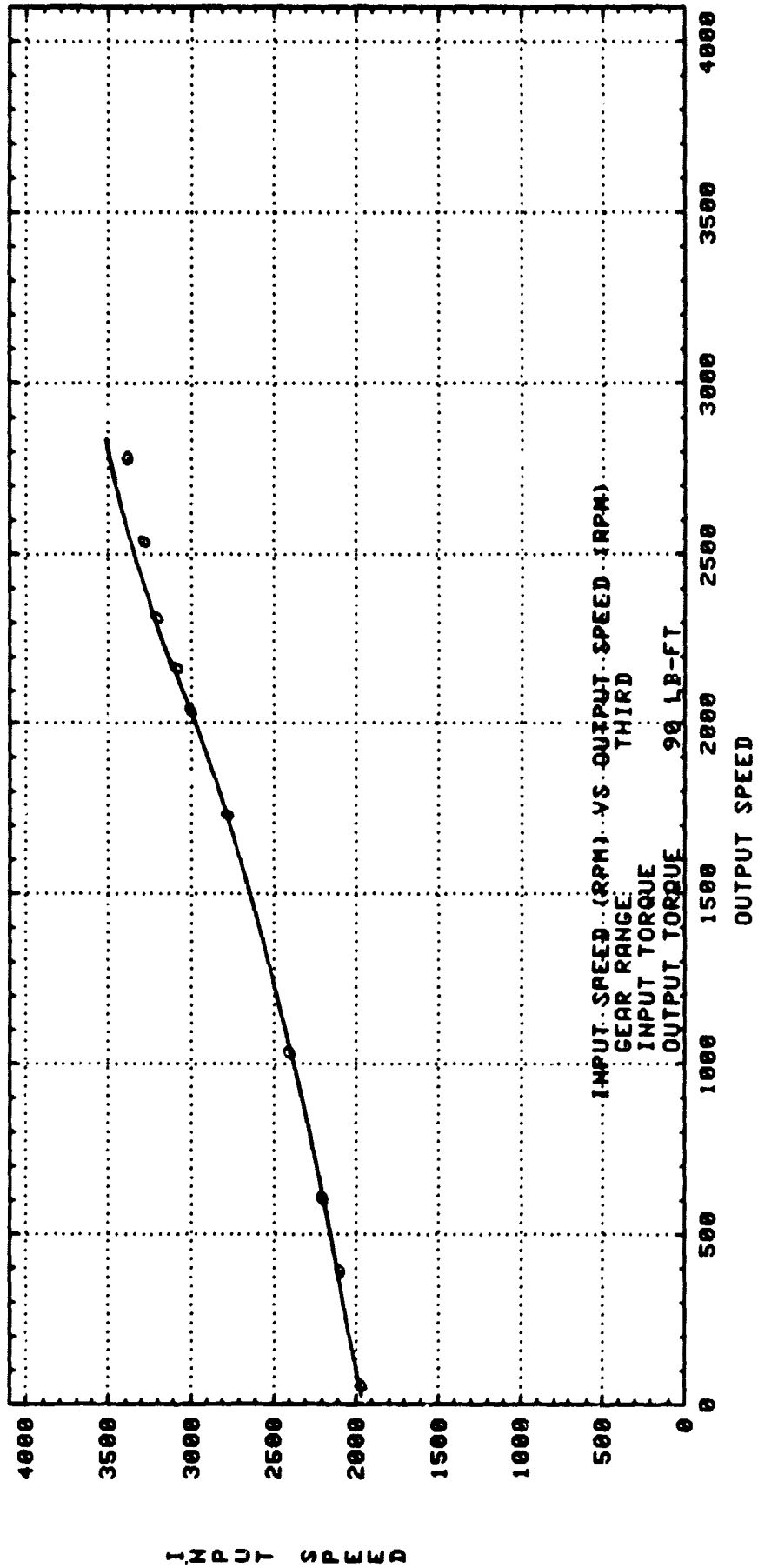

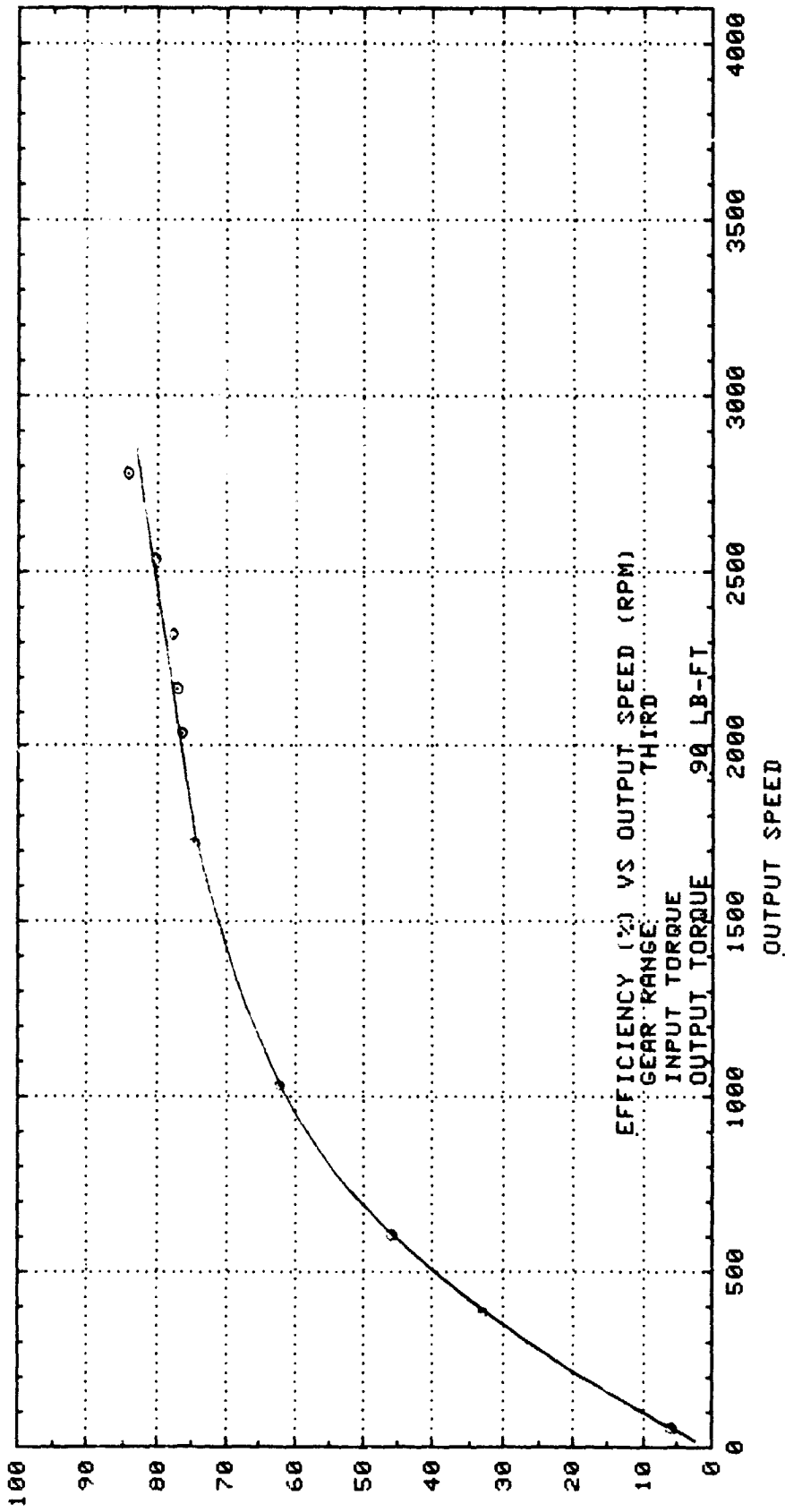

EFFICIENCY

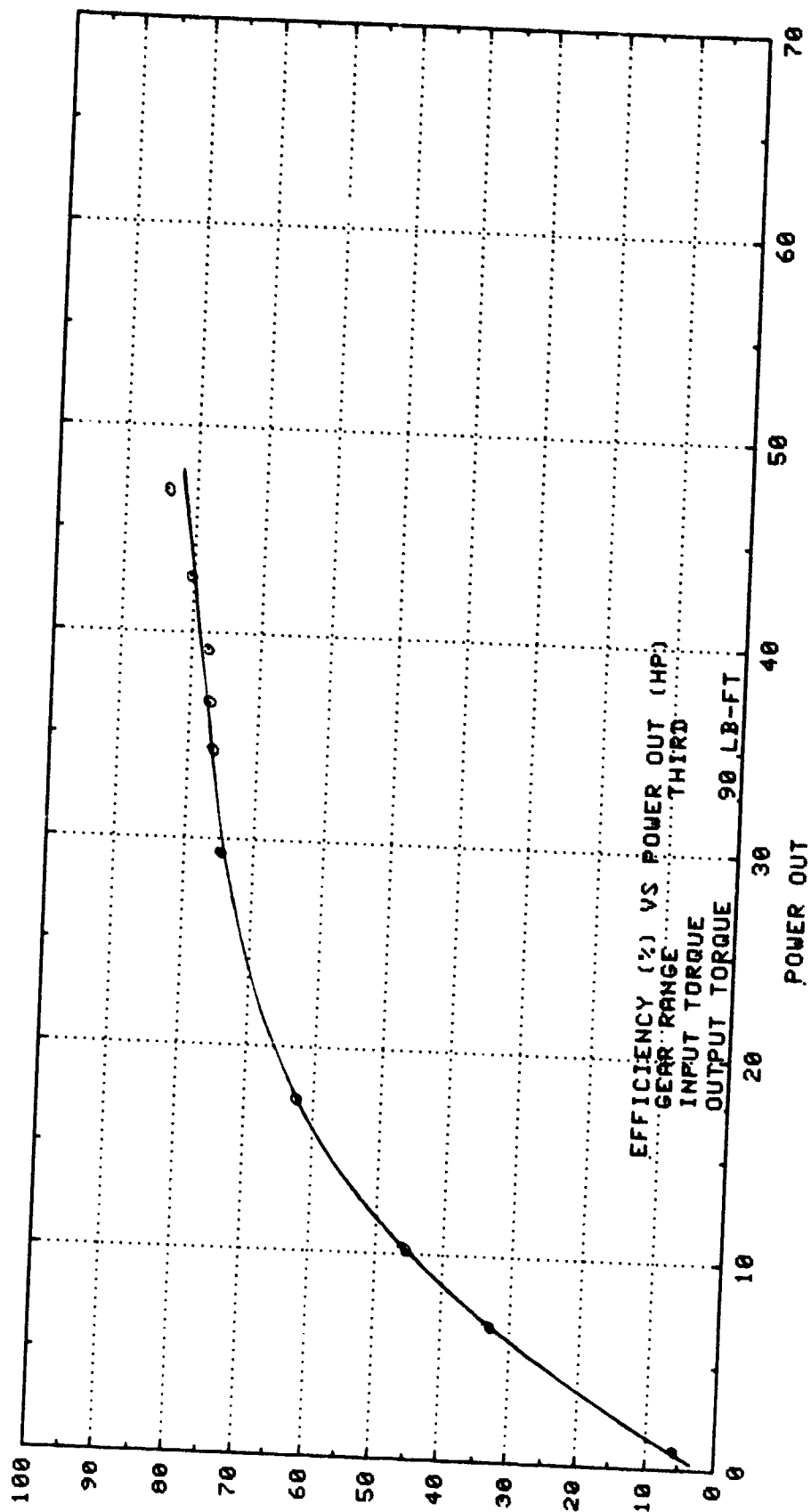

**COAST PERFORMANCE**

**1st Gear**

**Graphs Contained in This Section**

- Torque Ratio -vs- Output Speed**
- Output Torque -vs- Output Speed**
- Input Speed -vs- Output Speed**
- Efficiency -vs- Output Speed**
- Efficiency -vs- Power Out**

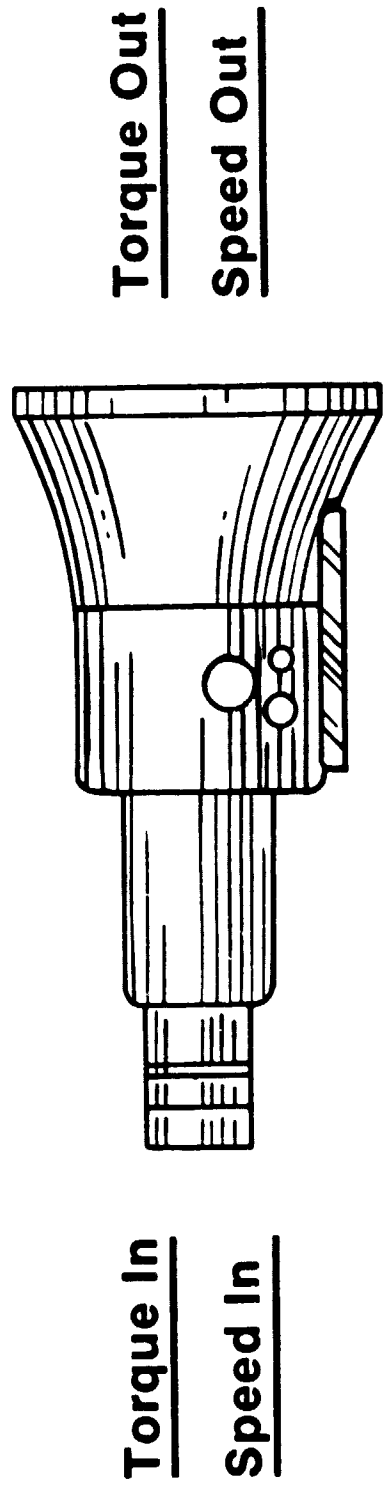

---

**Coast Performance Tests**



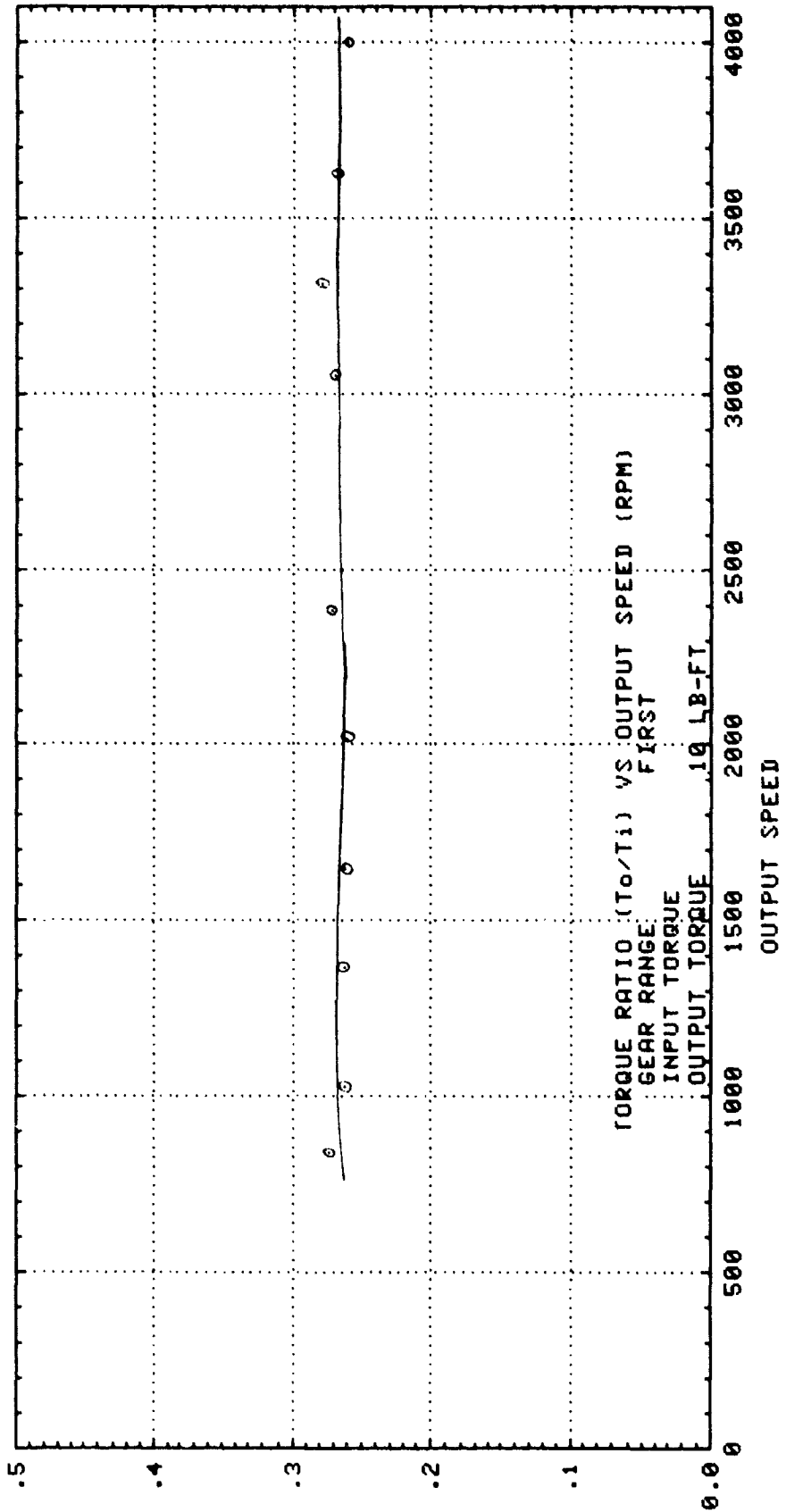

TORQUE RATIO

INPUT TORQUE

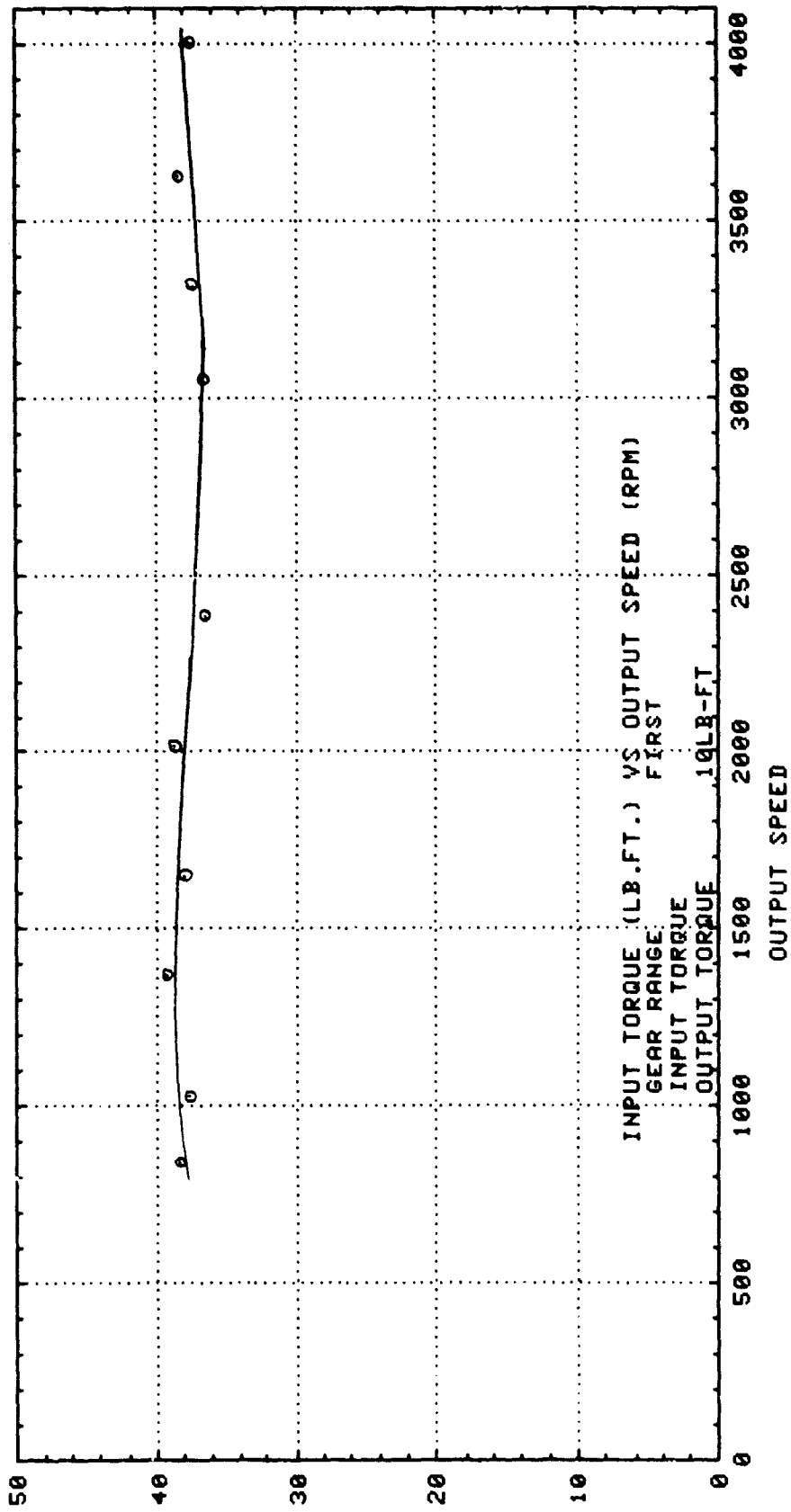

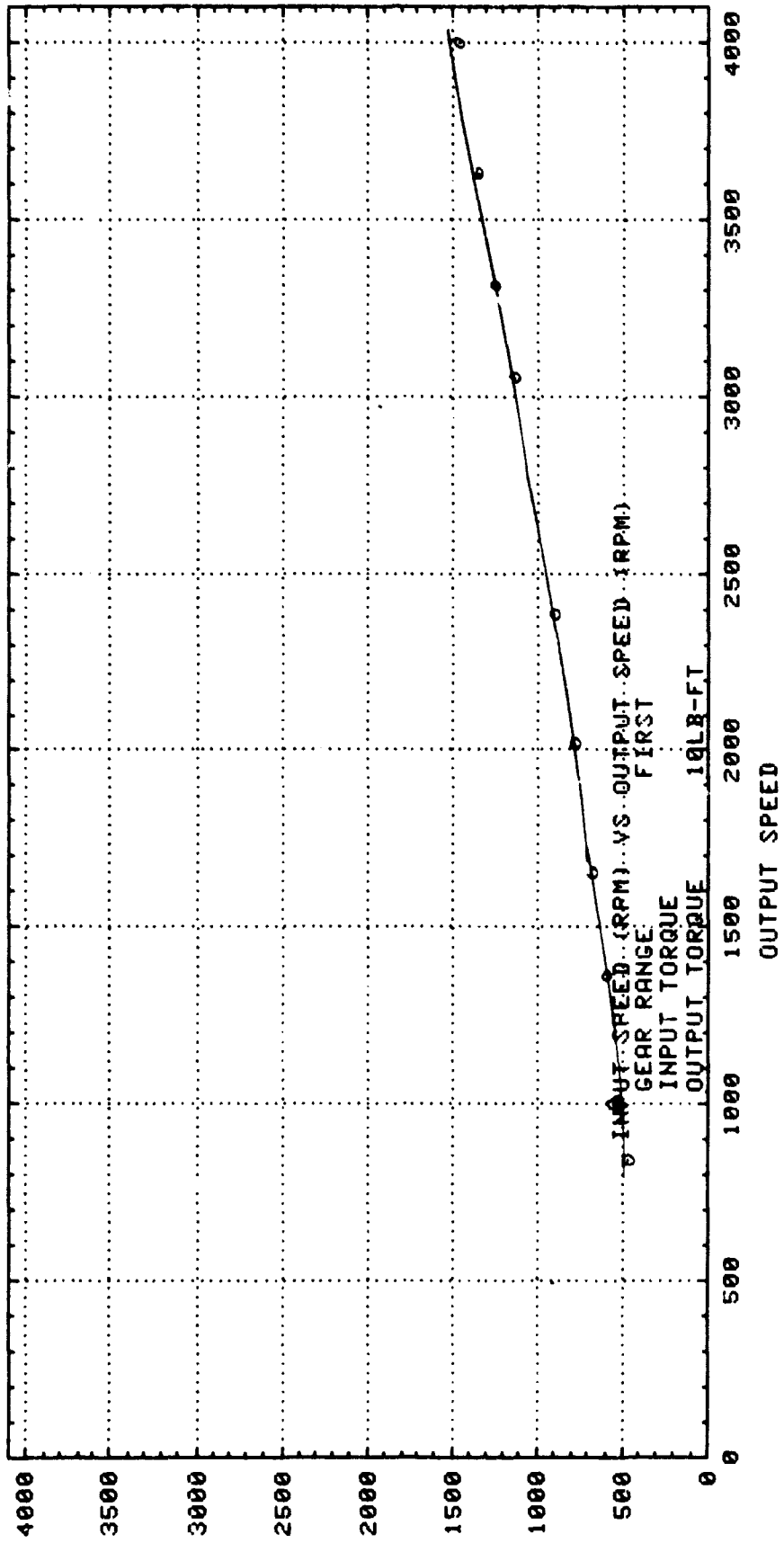

INPUT SPEED

E F F I C I E N C Y

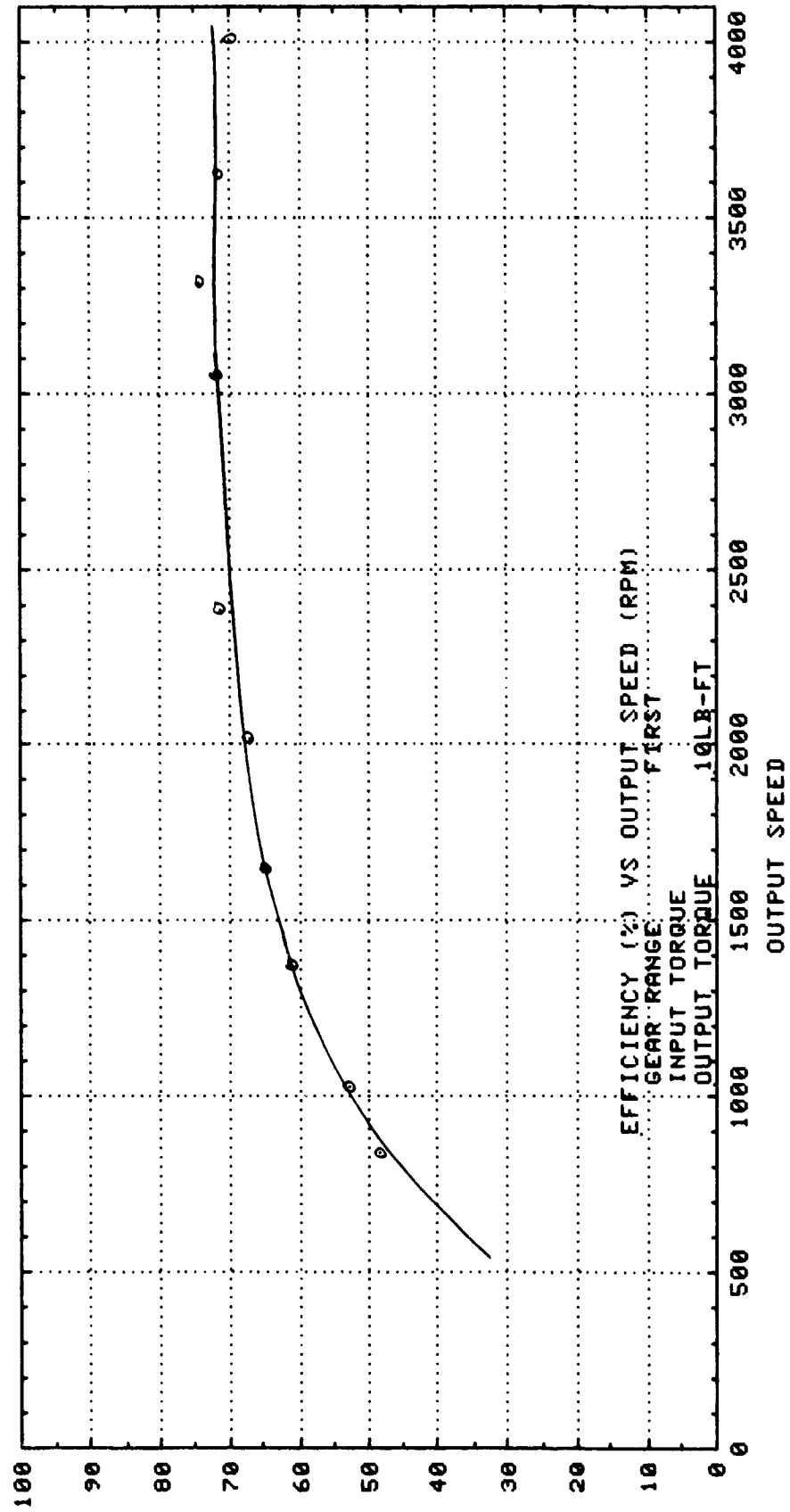

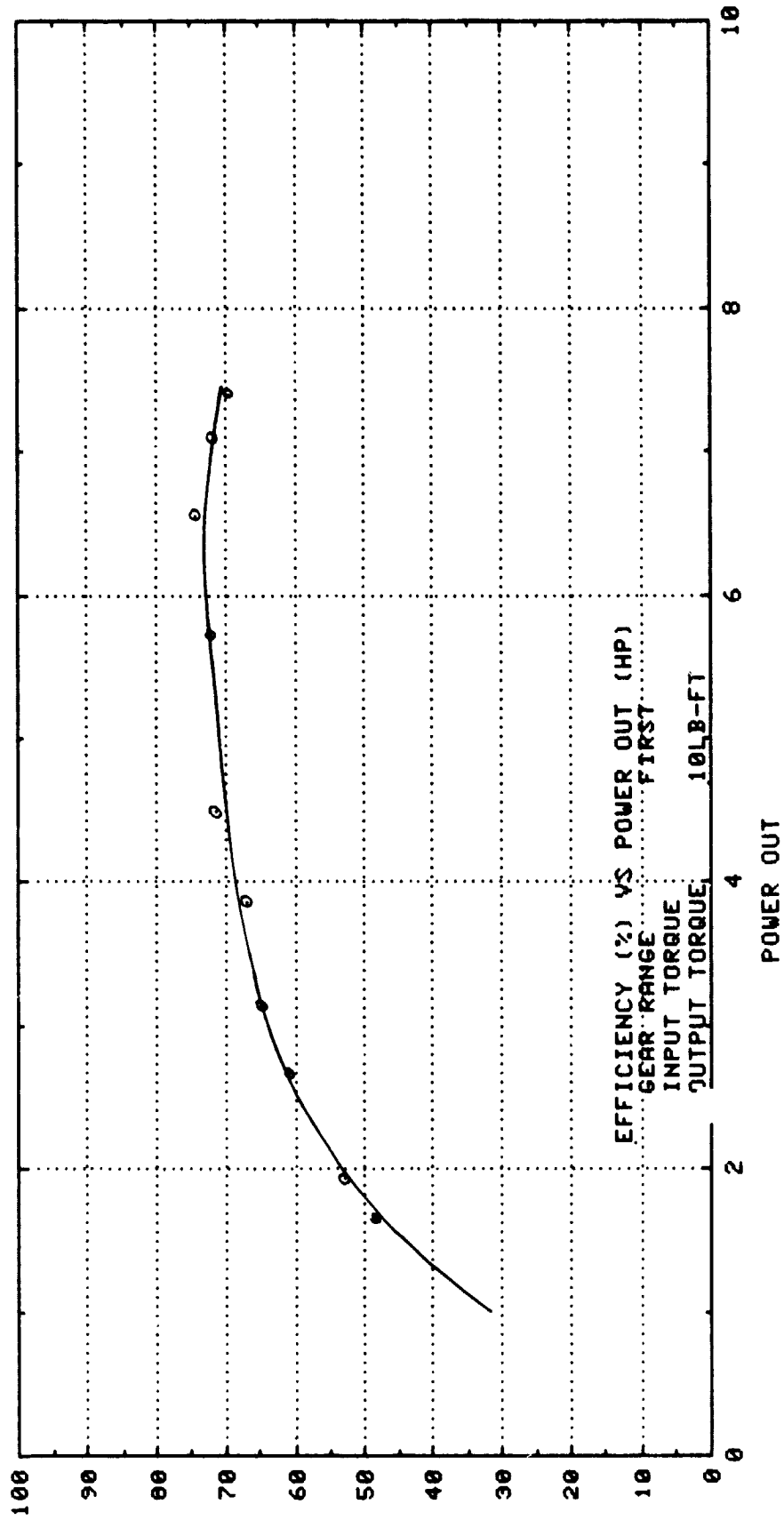

EFFICIENCY

TORQUE RATIO

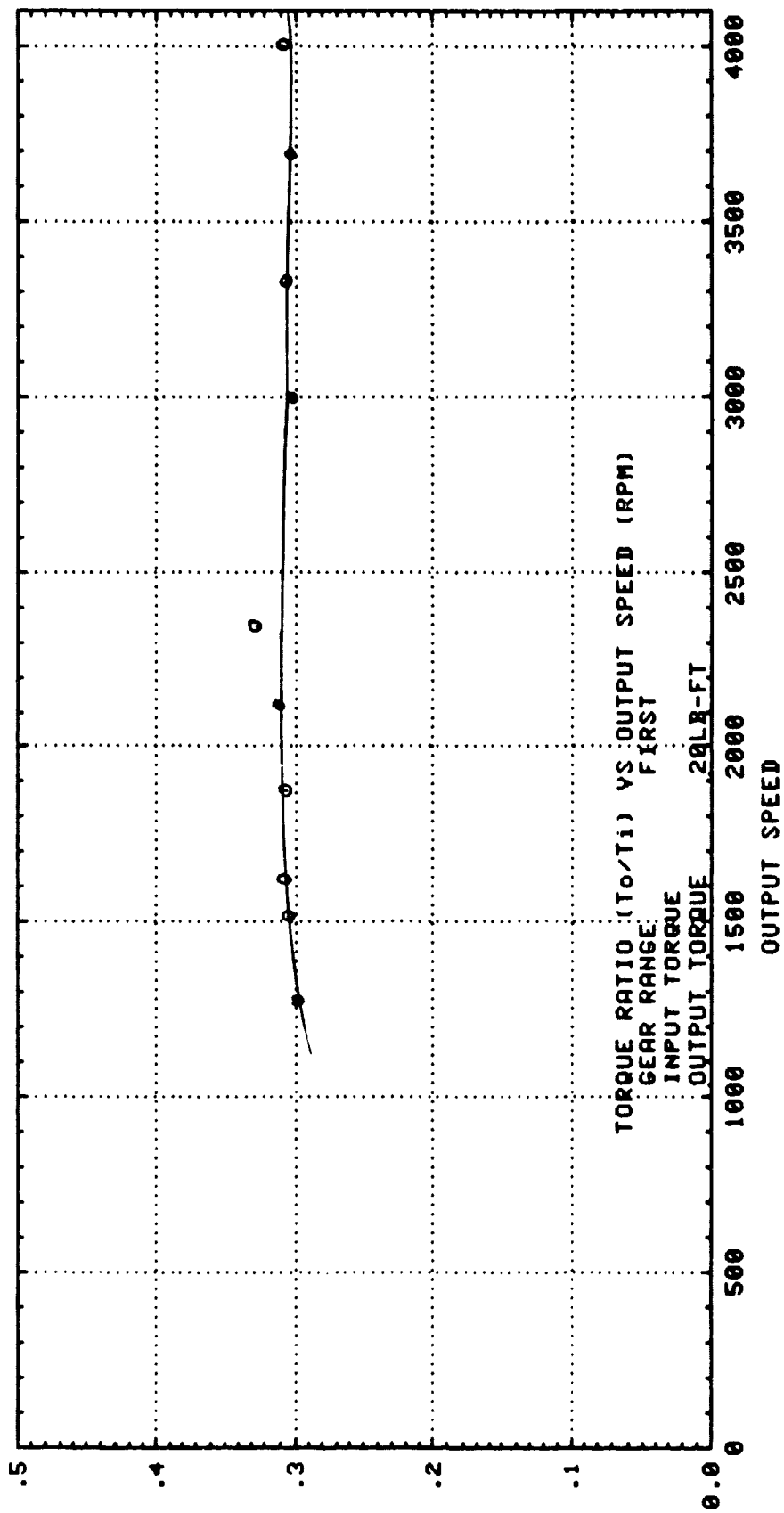

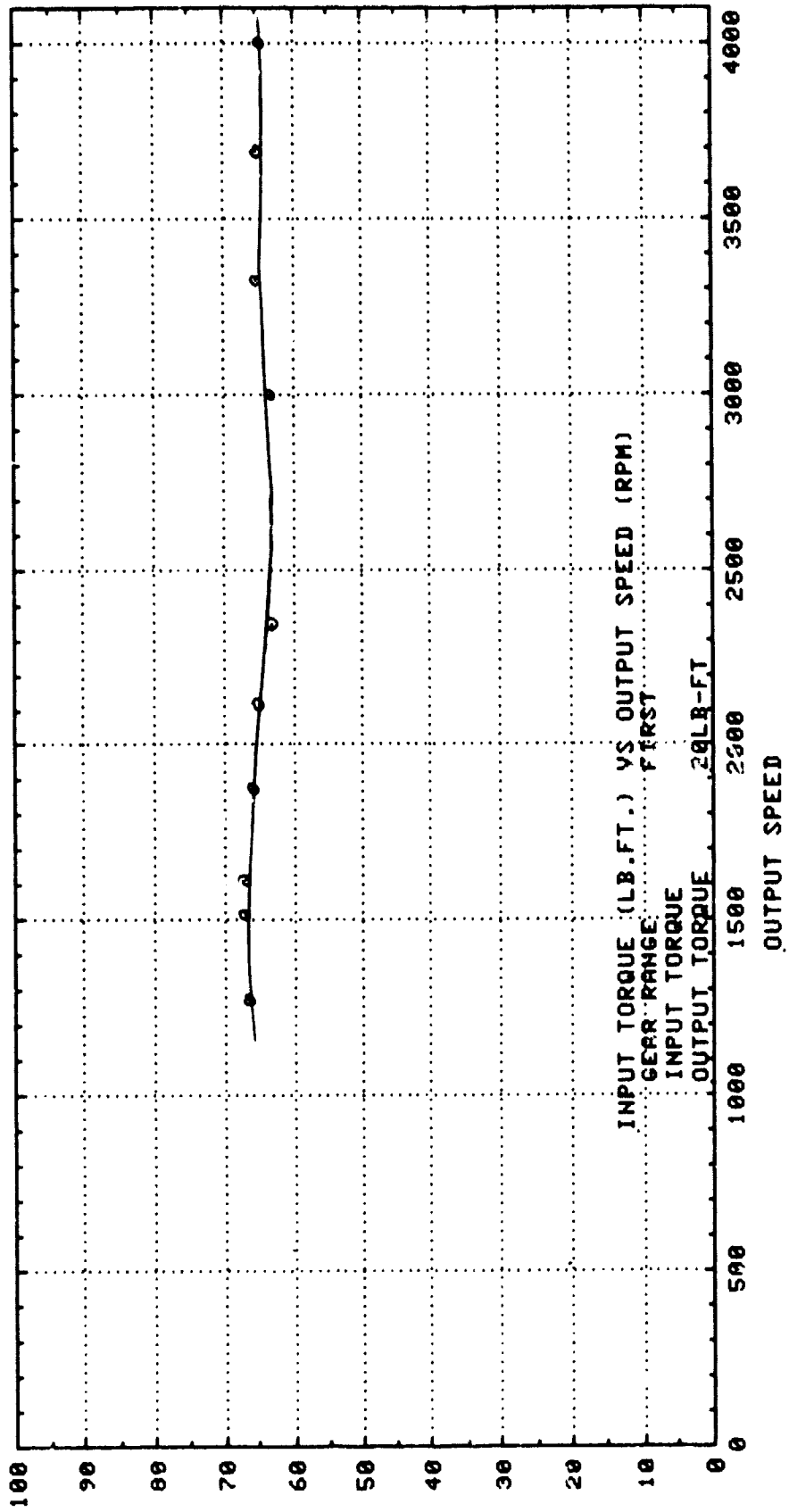

INPUT TORQUE

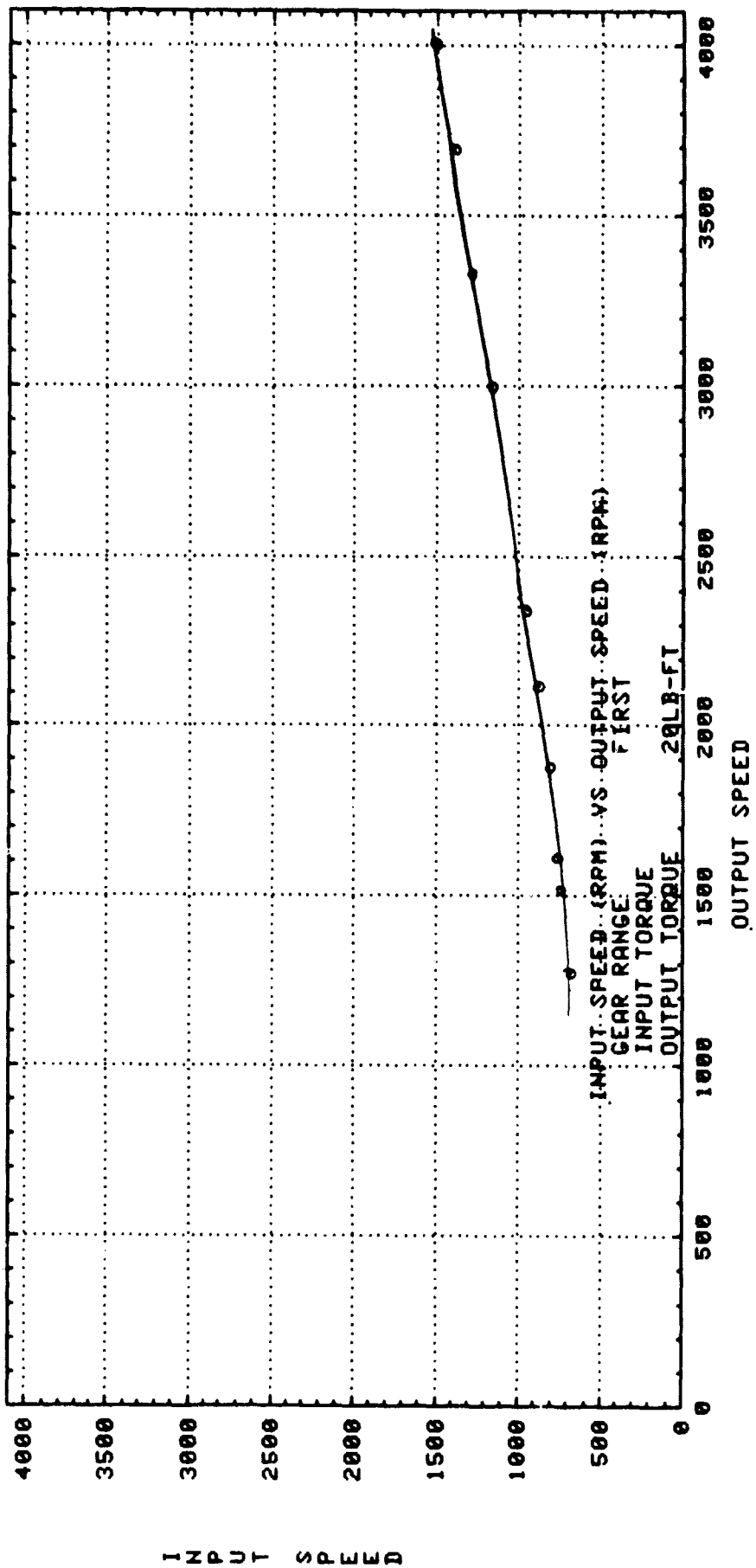

I N P U T S P E E D



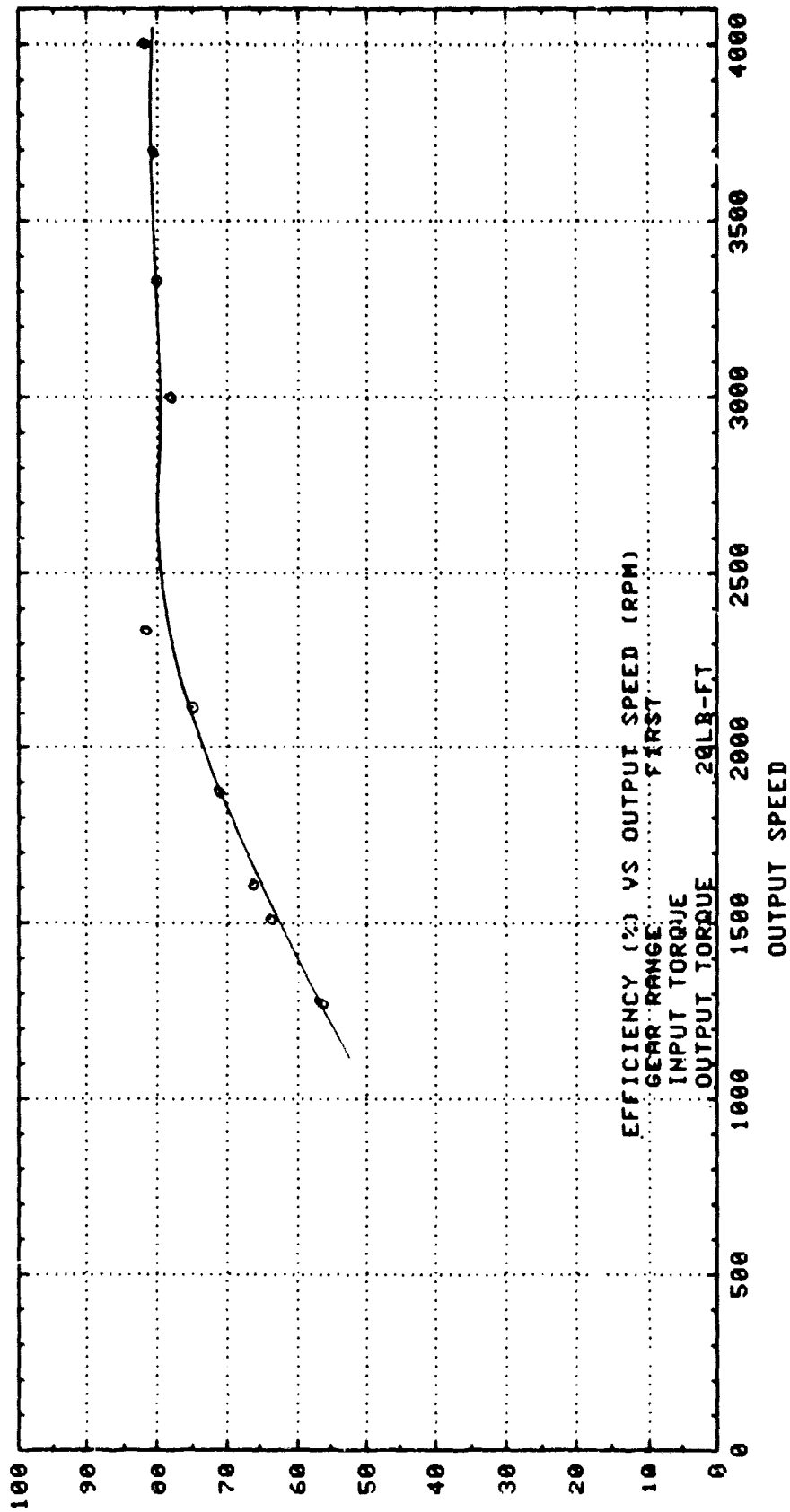

EFFICIENCY

EFFICIENCY

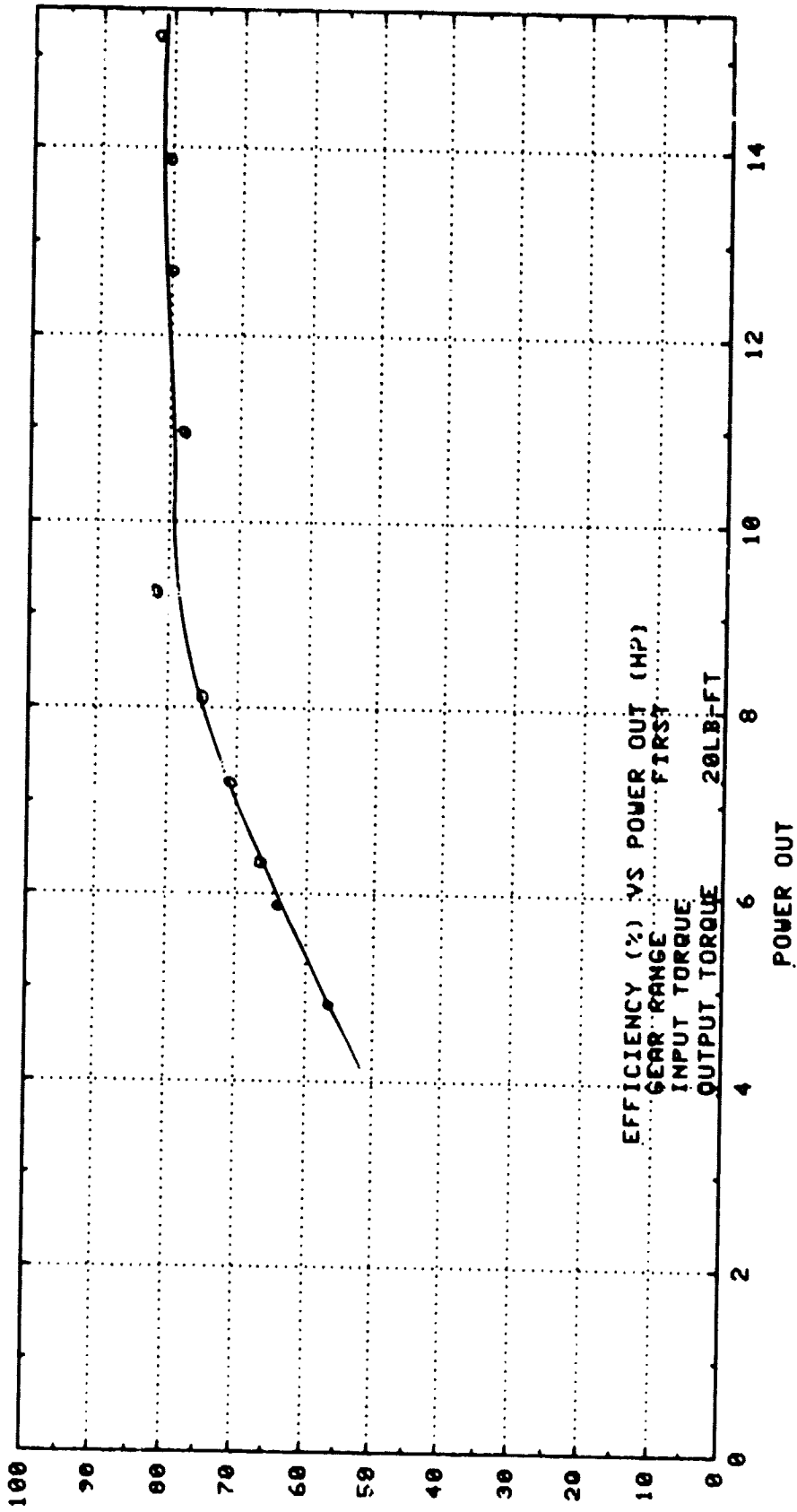

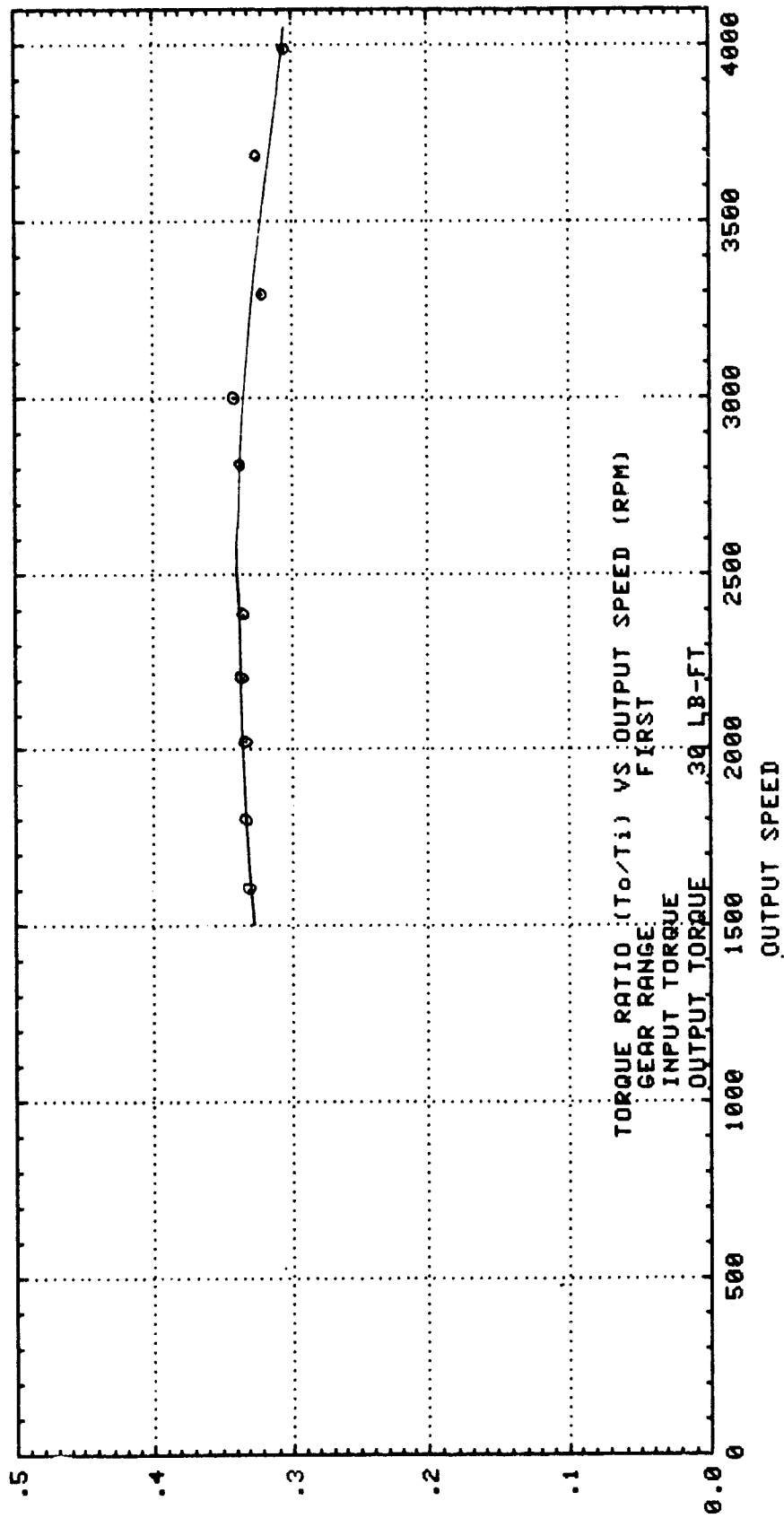

TORQUE RATIO

INPUT TORQUE

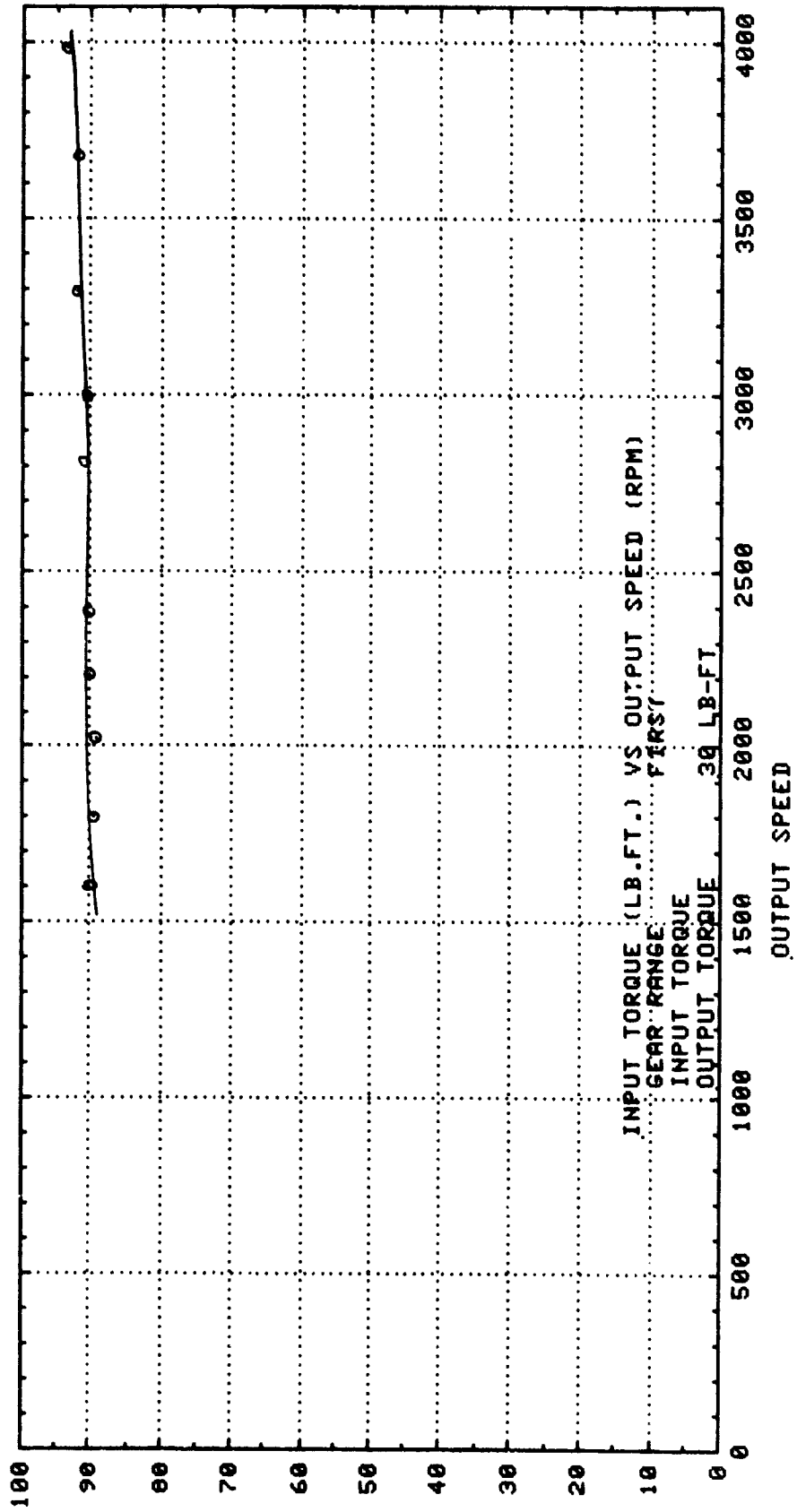

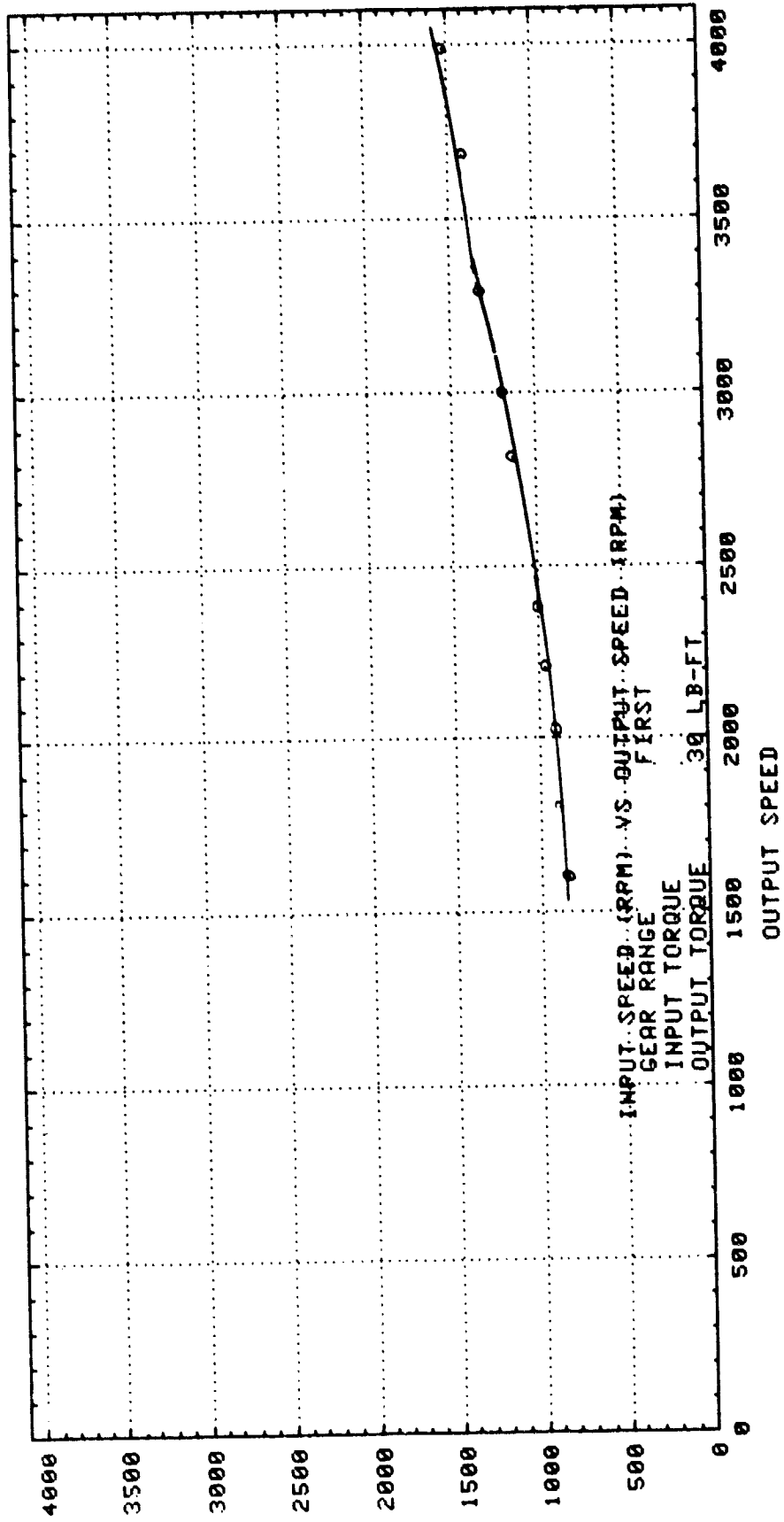

INPUT SPEED

EFFICIENCY

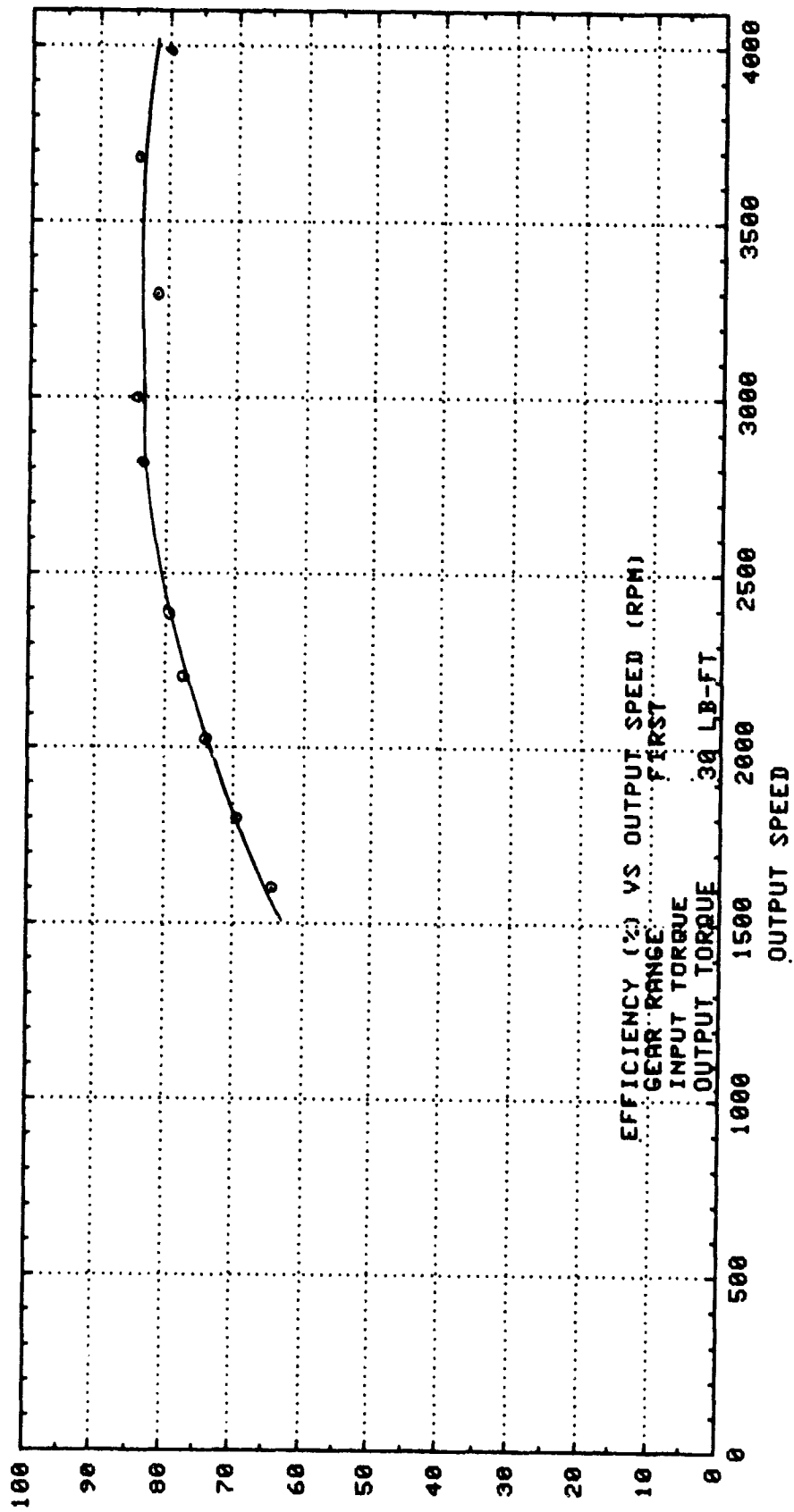

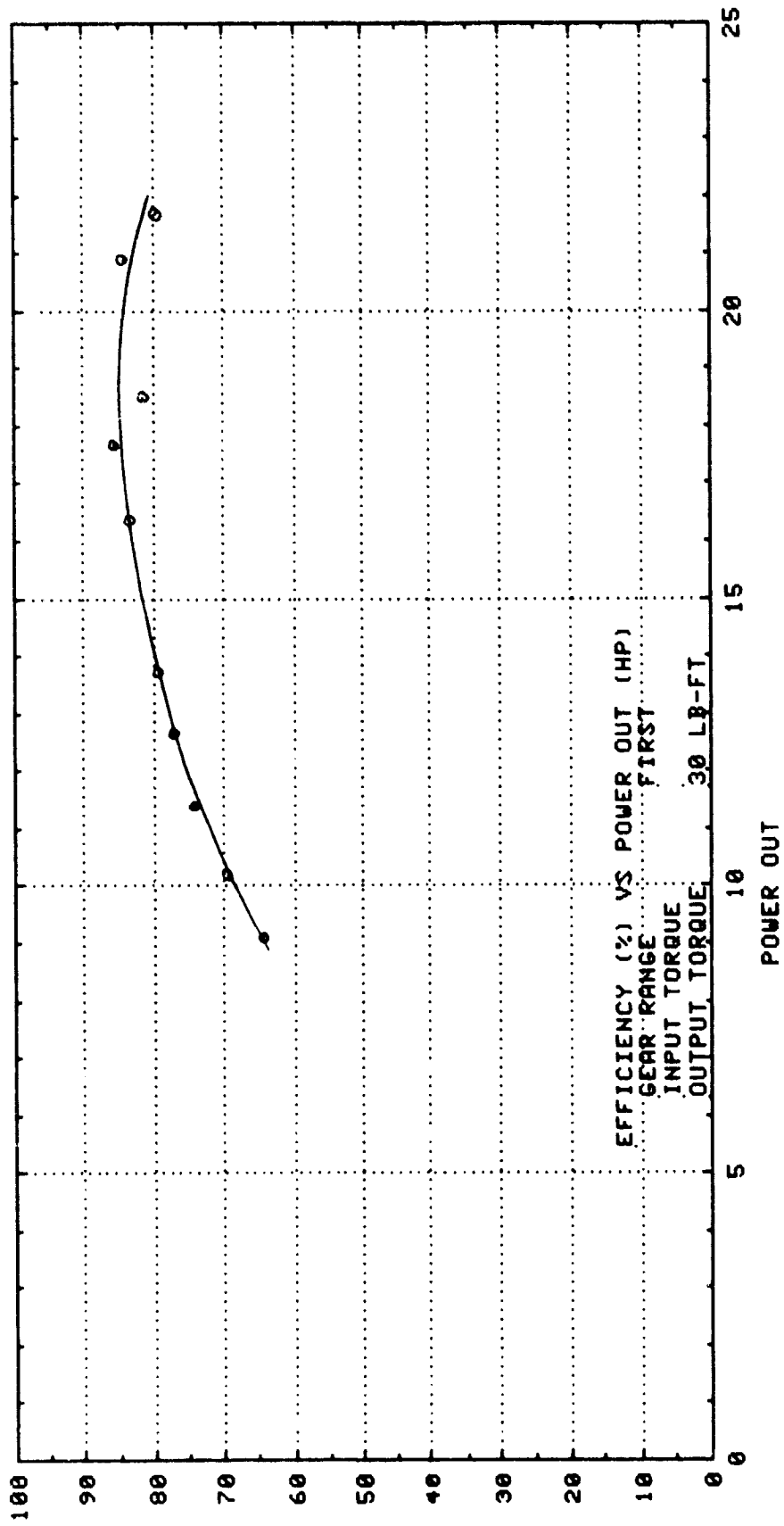

EFFICIENCY

TORQUE RATIO

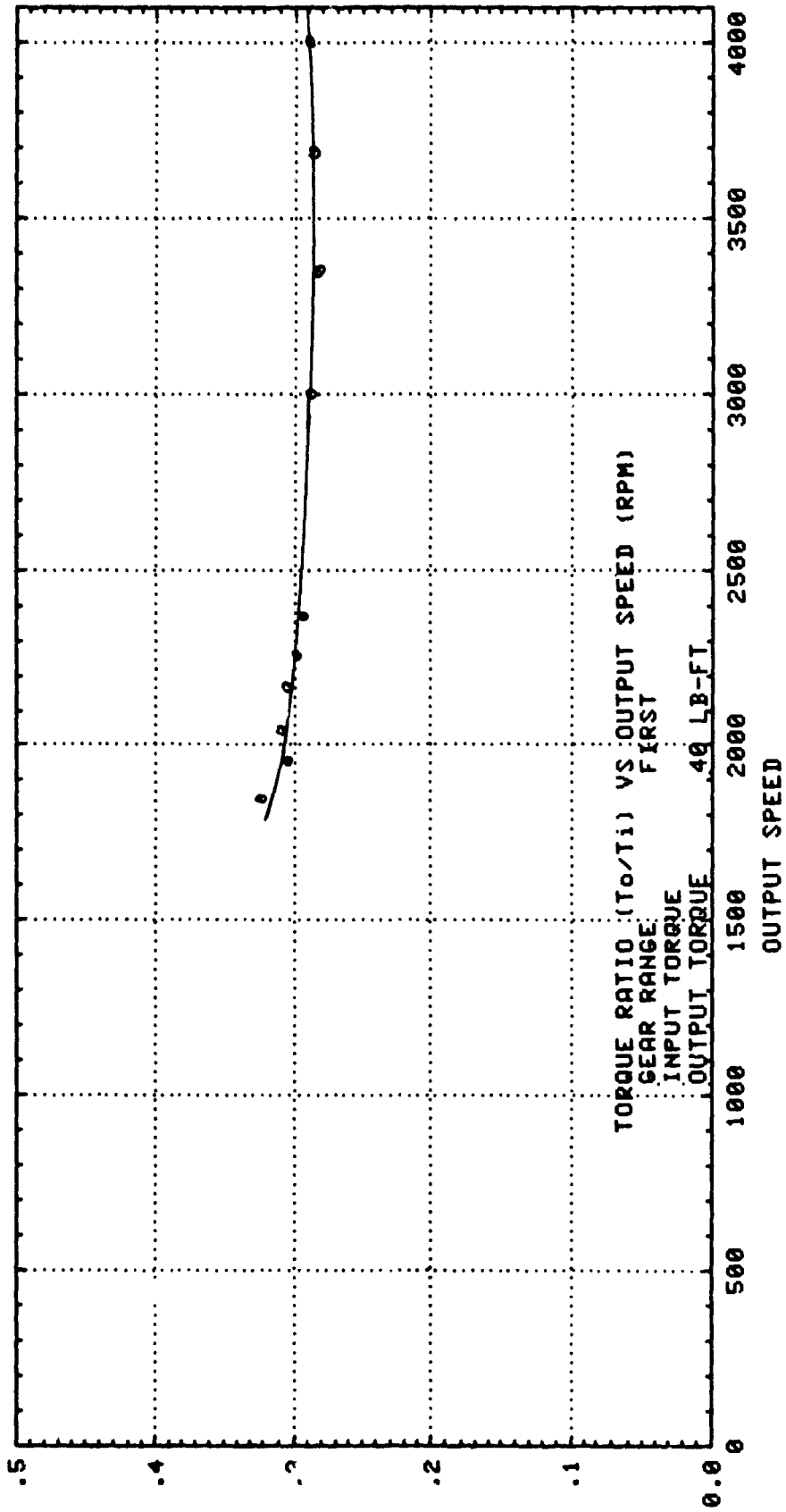



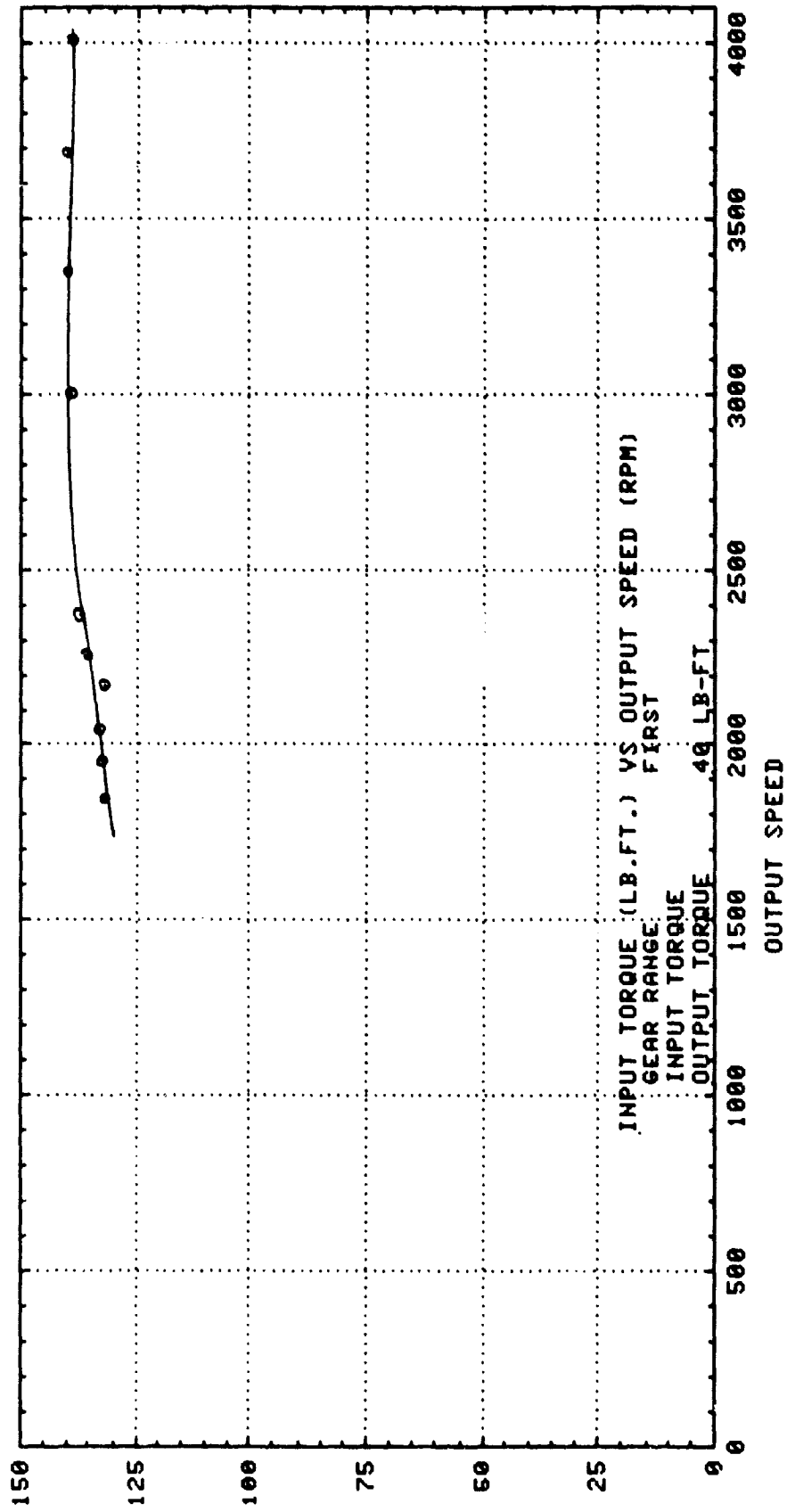

INPUT TORQUE

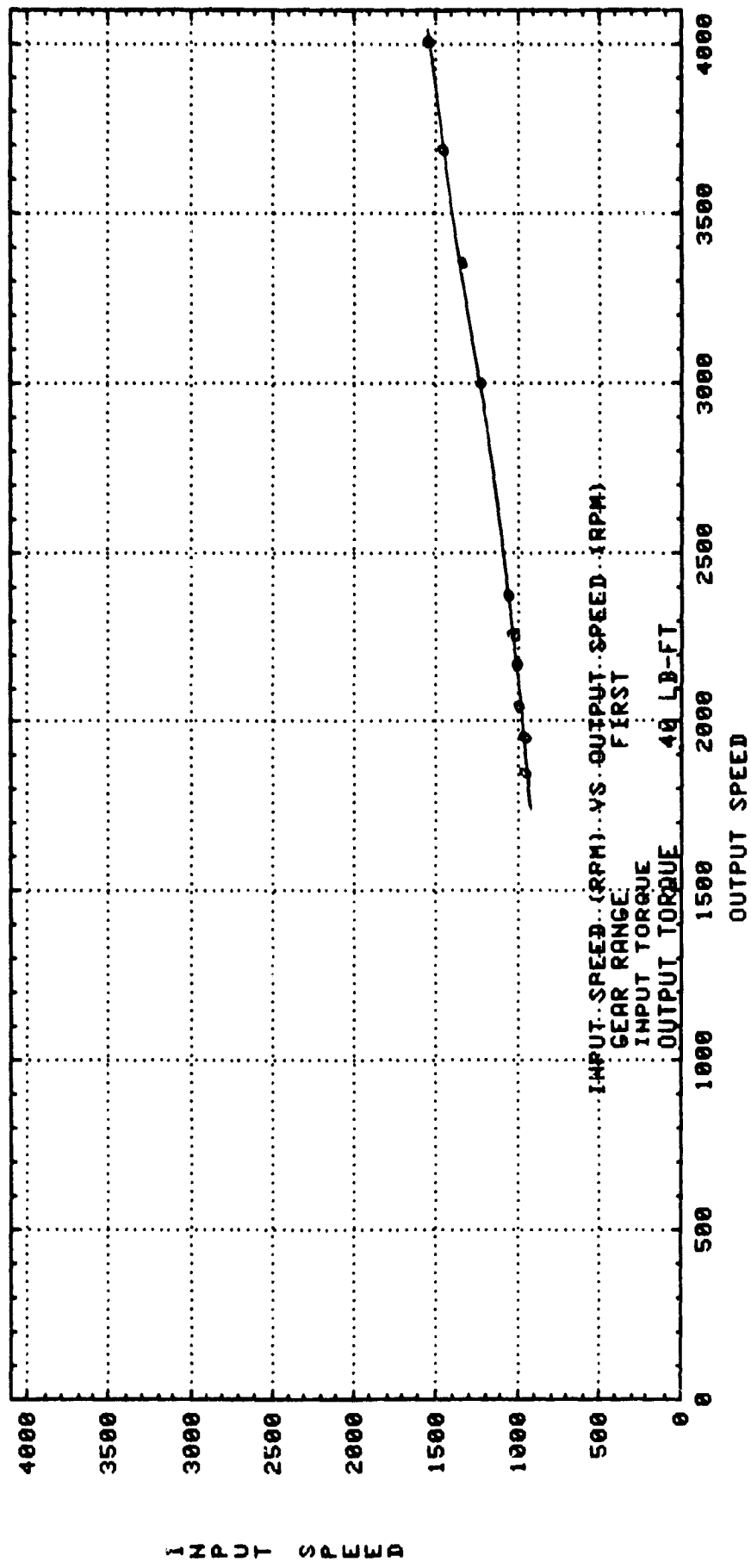

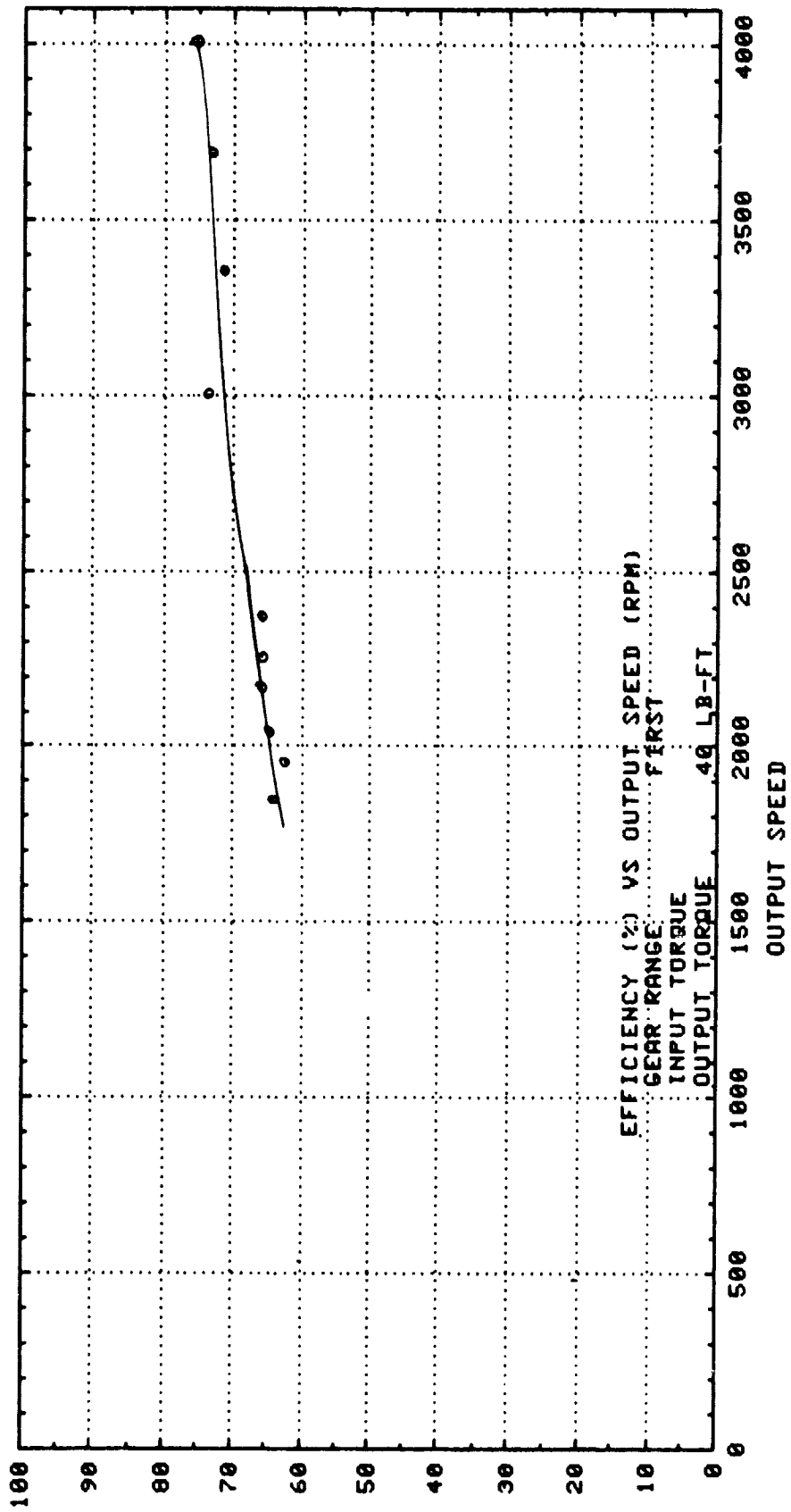

EFFICIENCY

EFFICIENCY

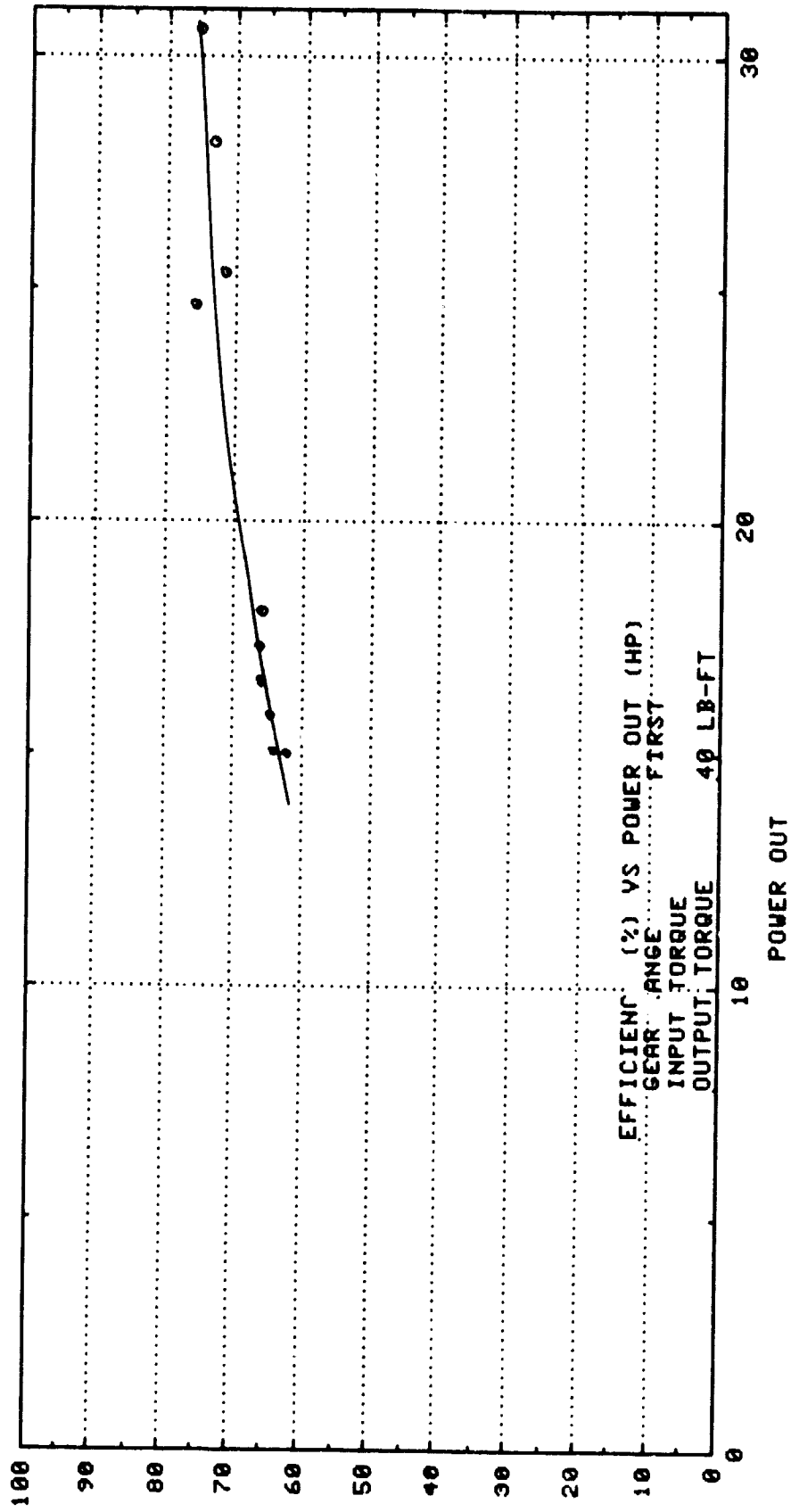

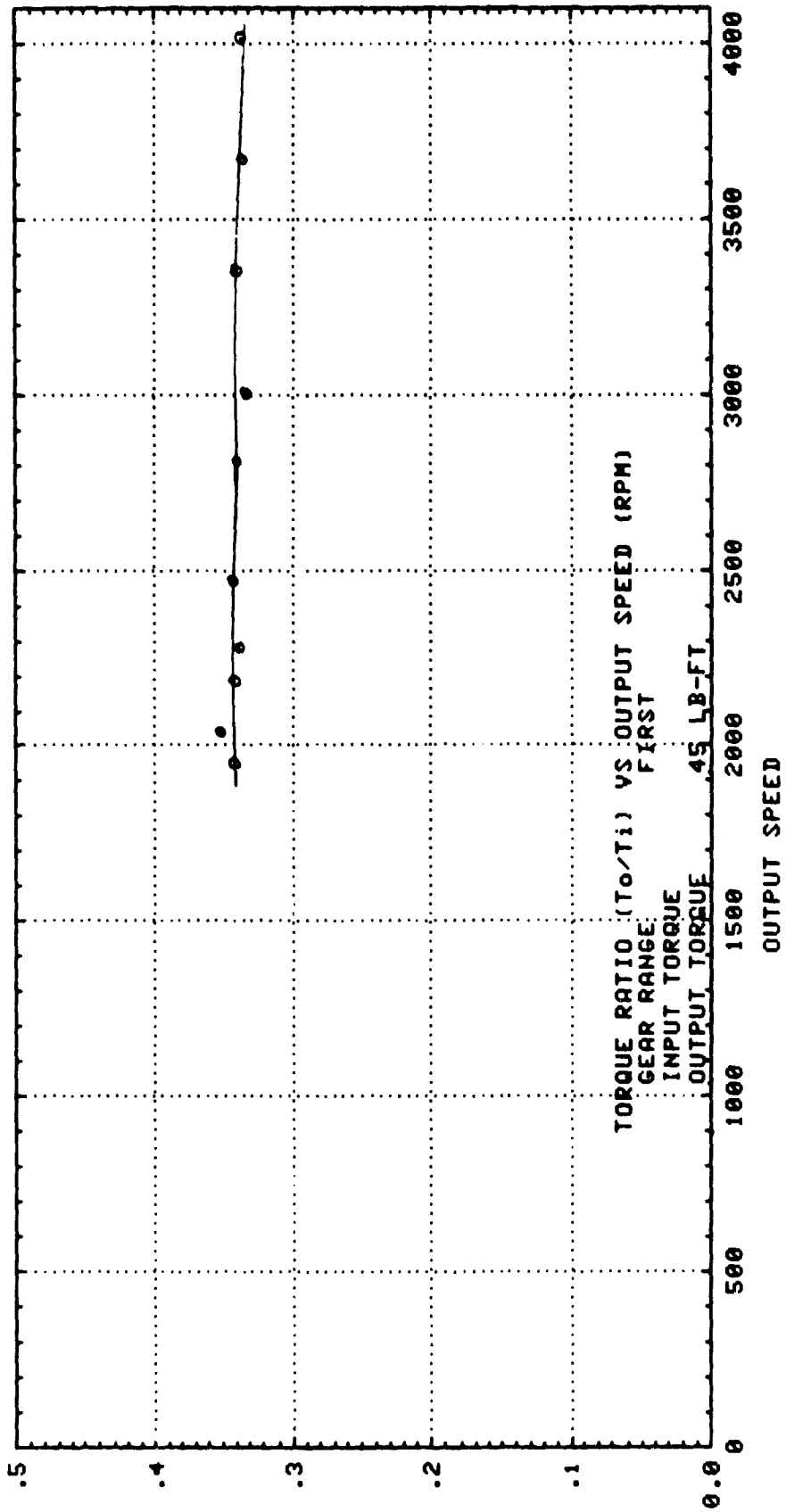

TORQUE RATIO

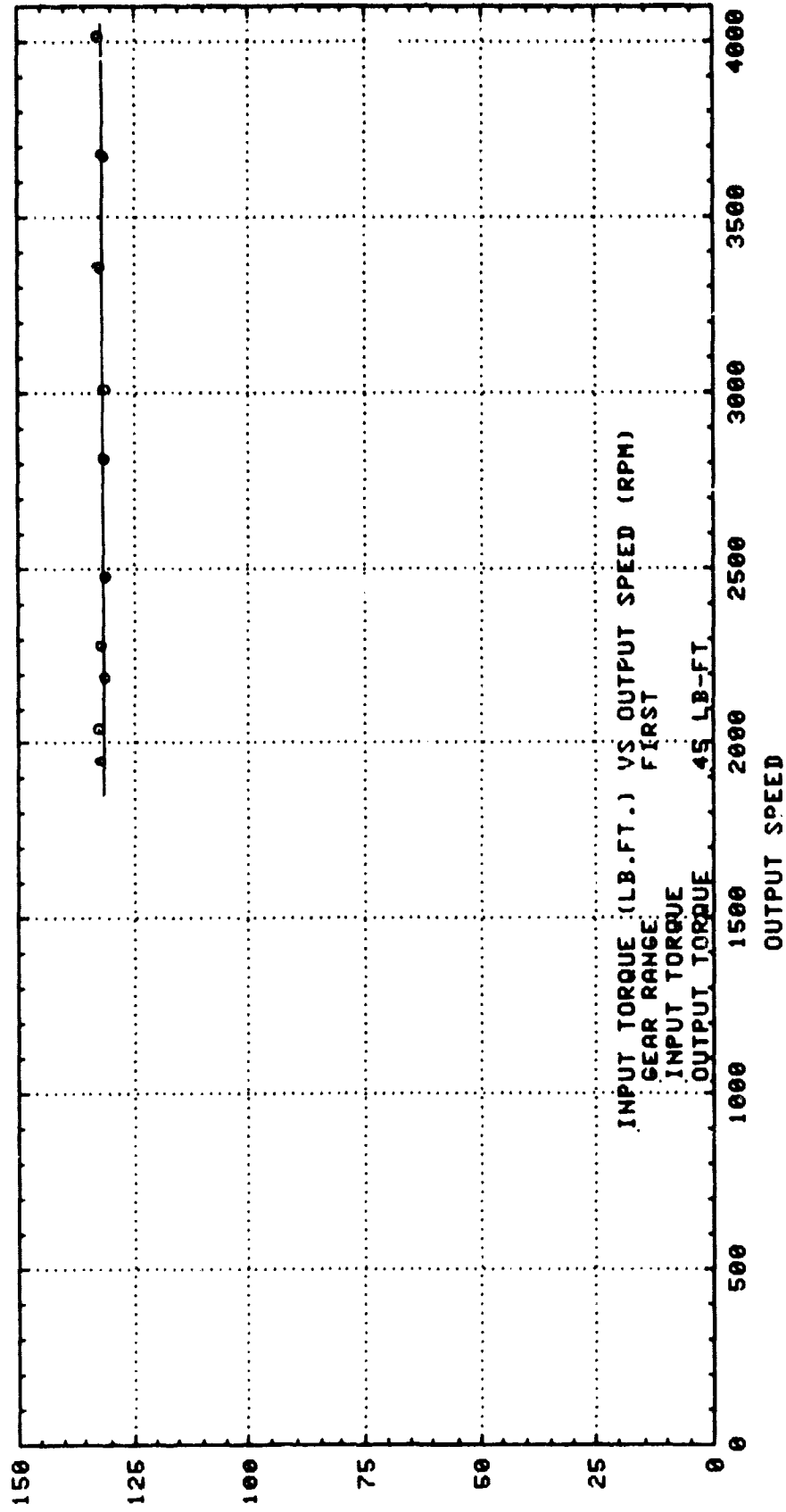

INPUT TORQUE

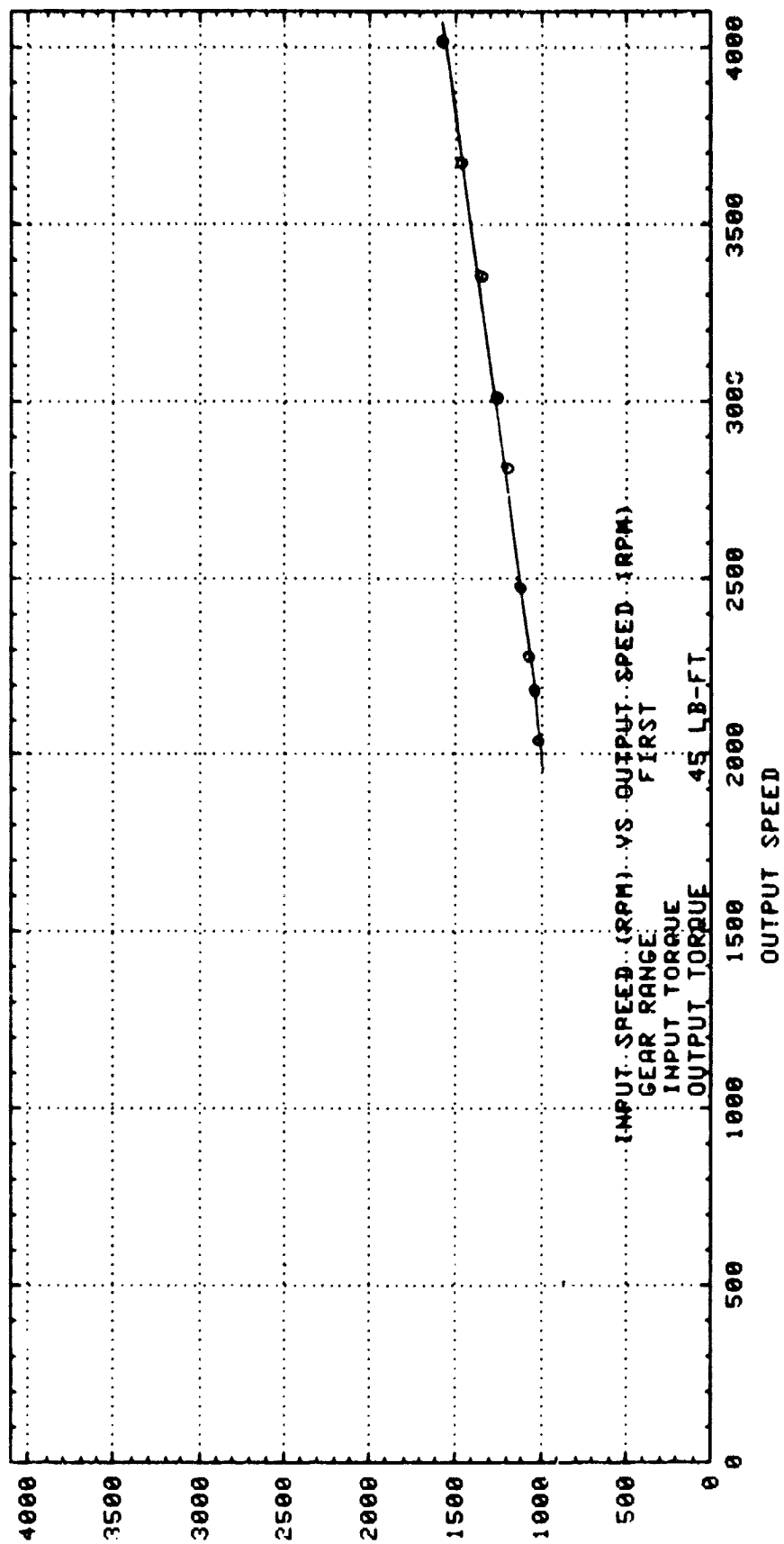

INPUT SPEED

EFFICIENCY

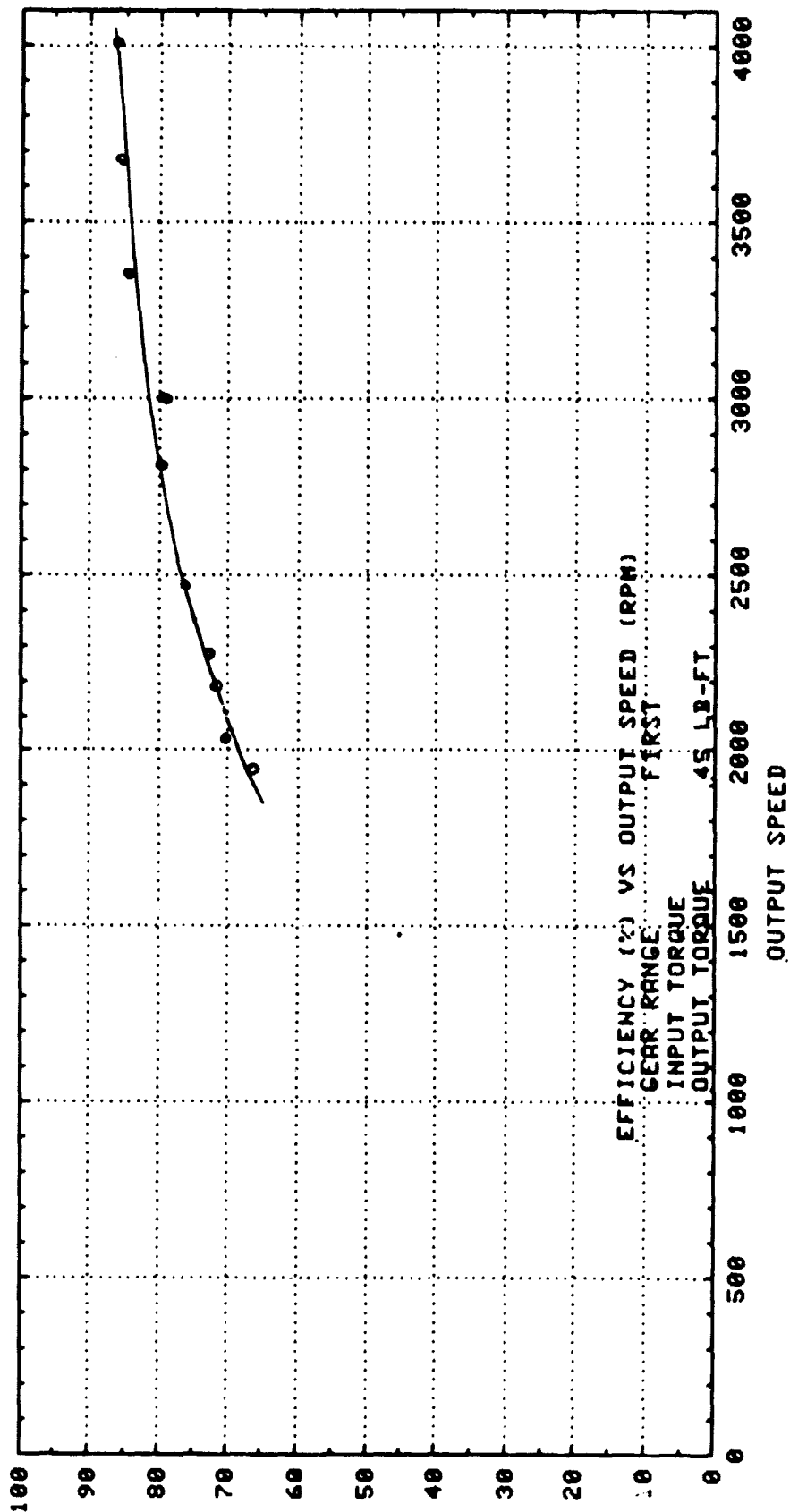



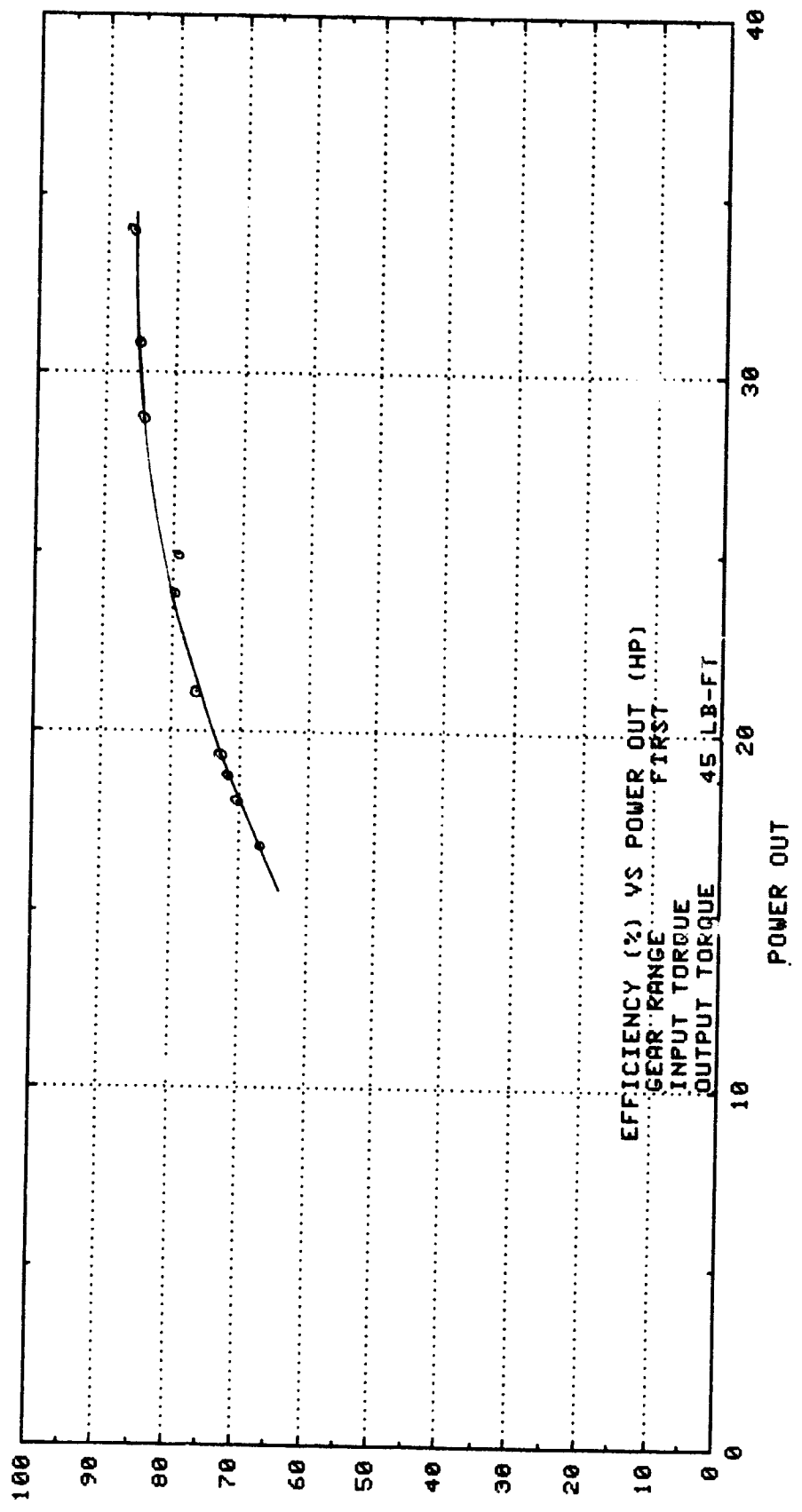

EFFICIENCY

TORQUE RATIO

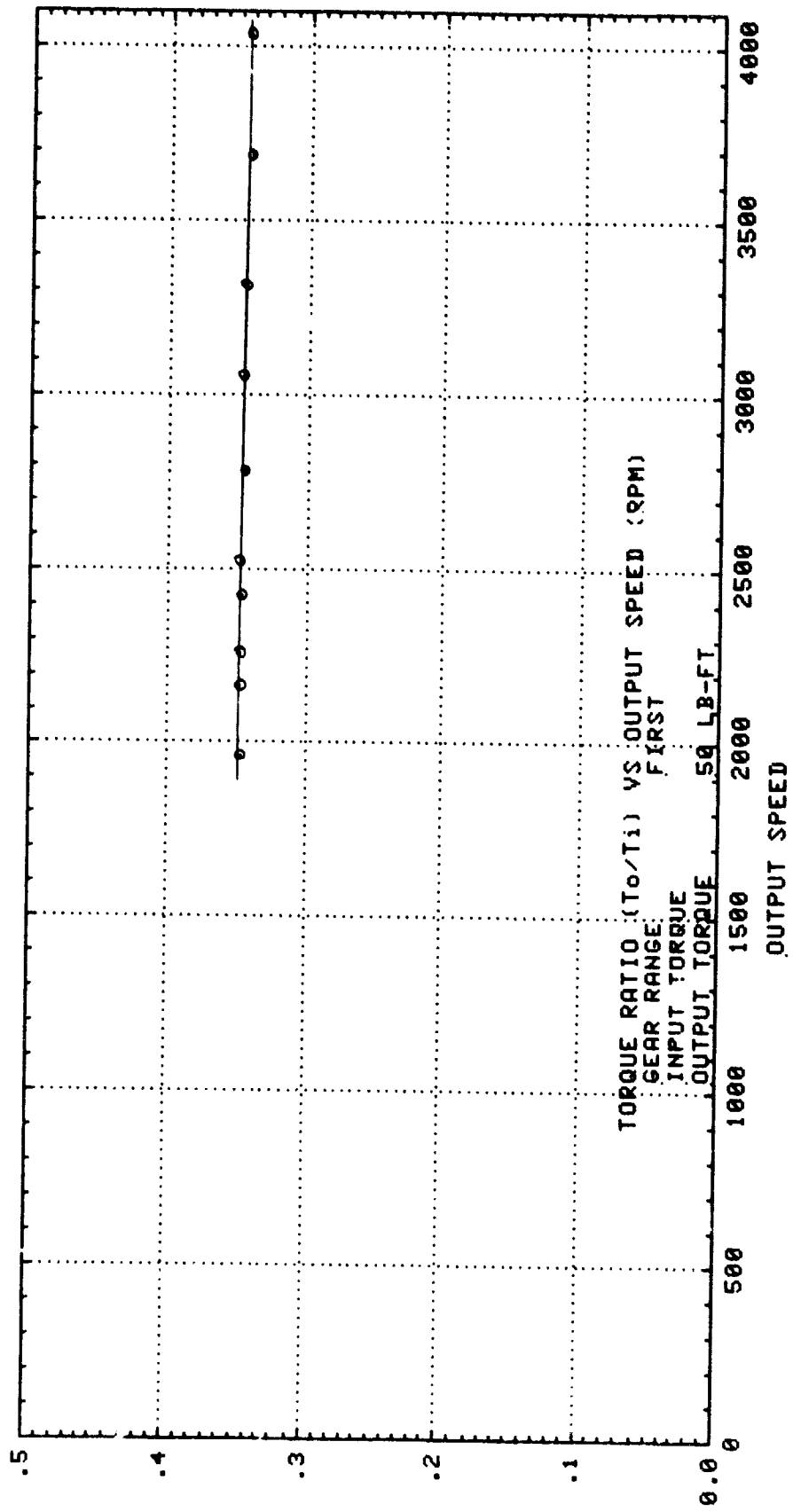

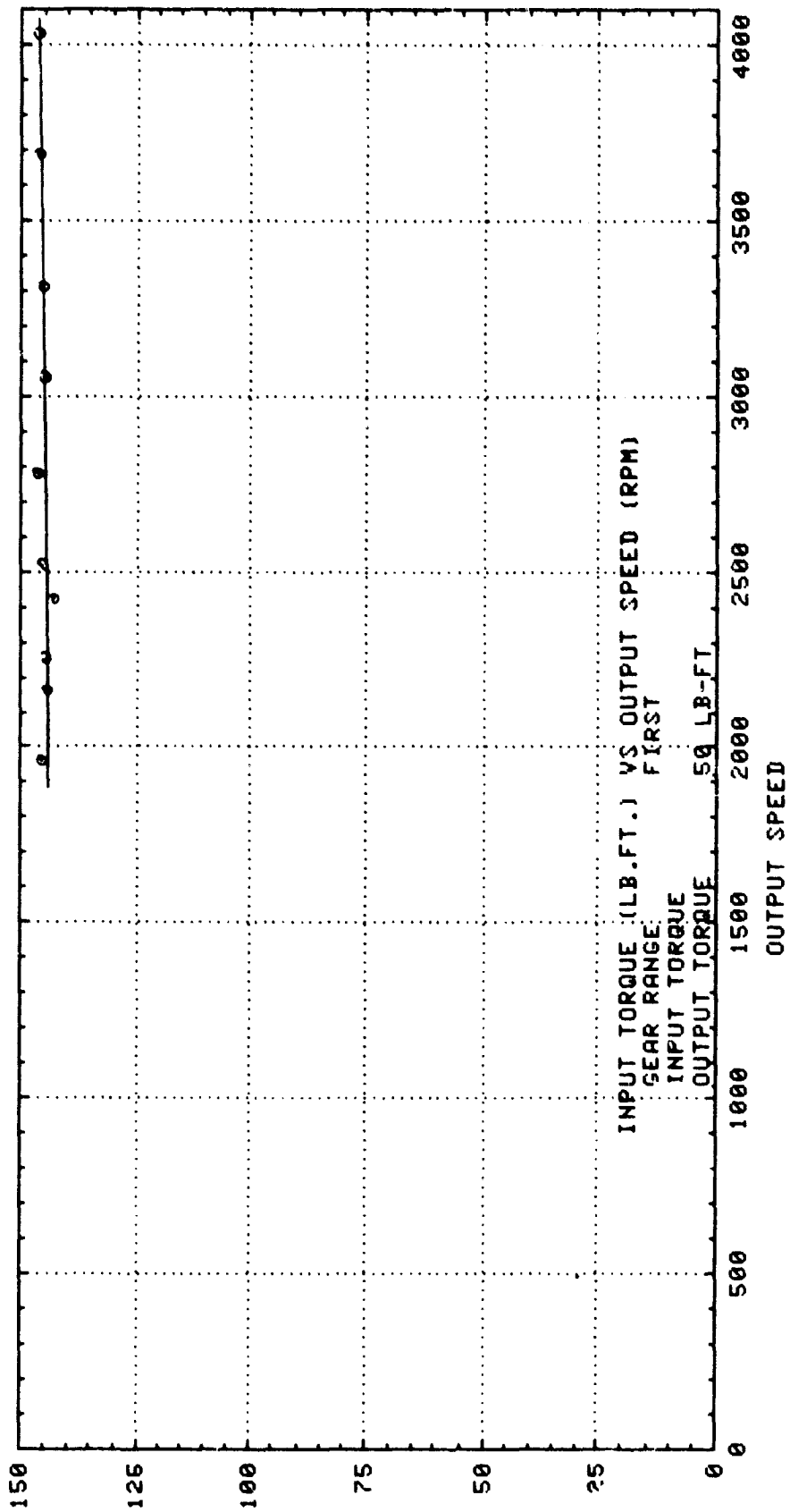

INPUT TORQUE

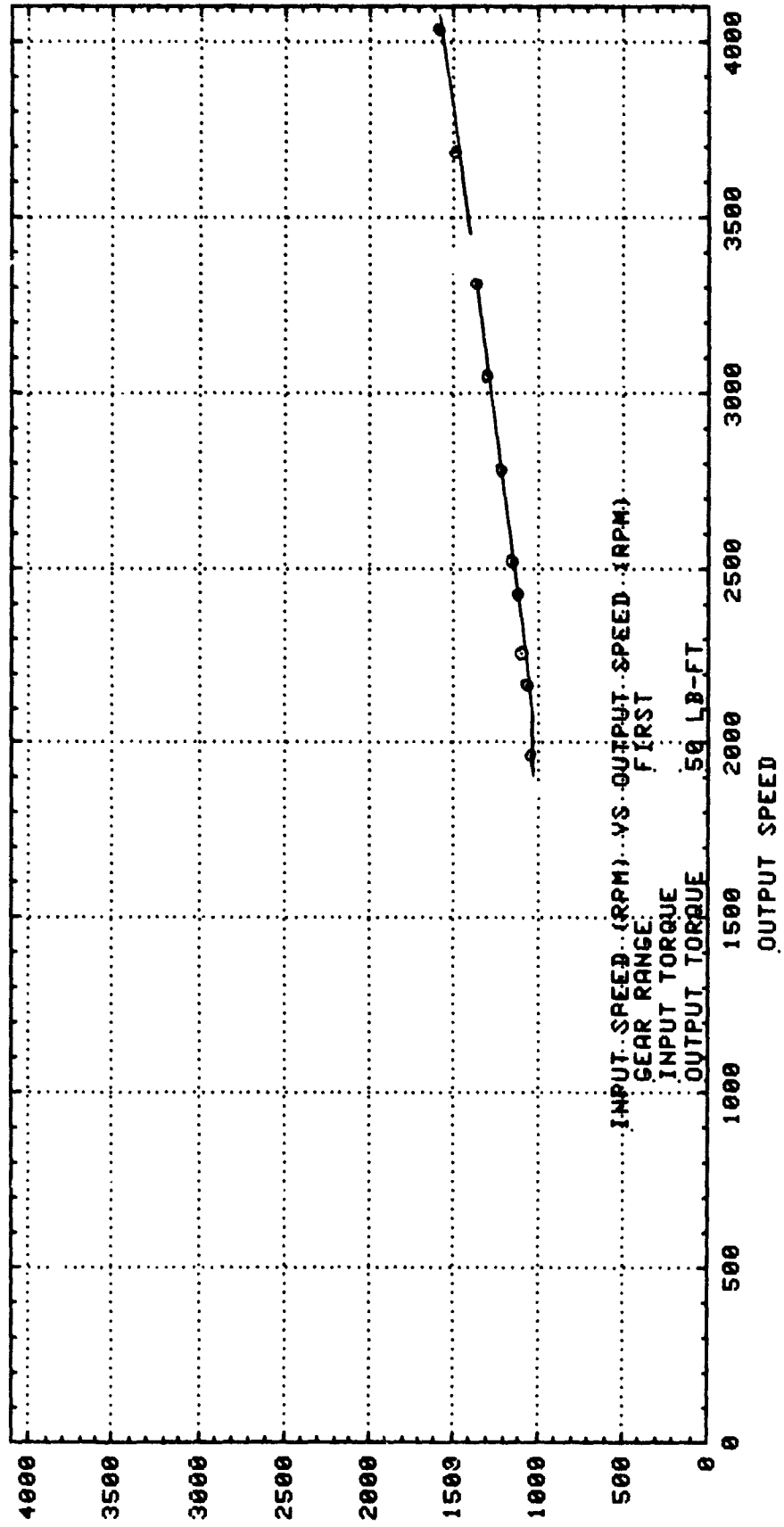

INPUT SPEED

OUTPUT SPEED

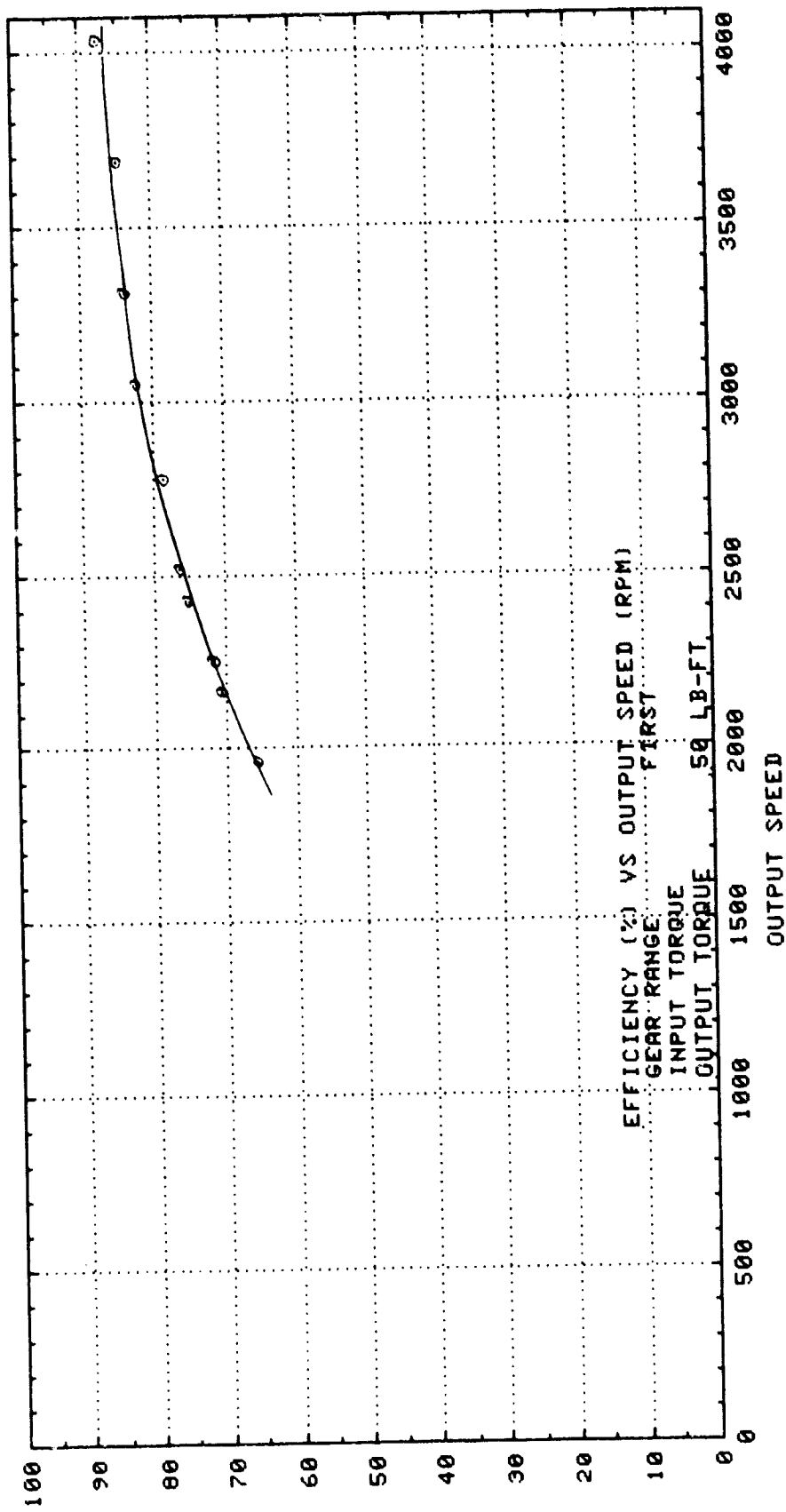

EFFICIENCY

E F F I C I E N C Y

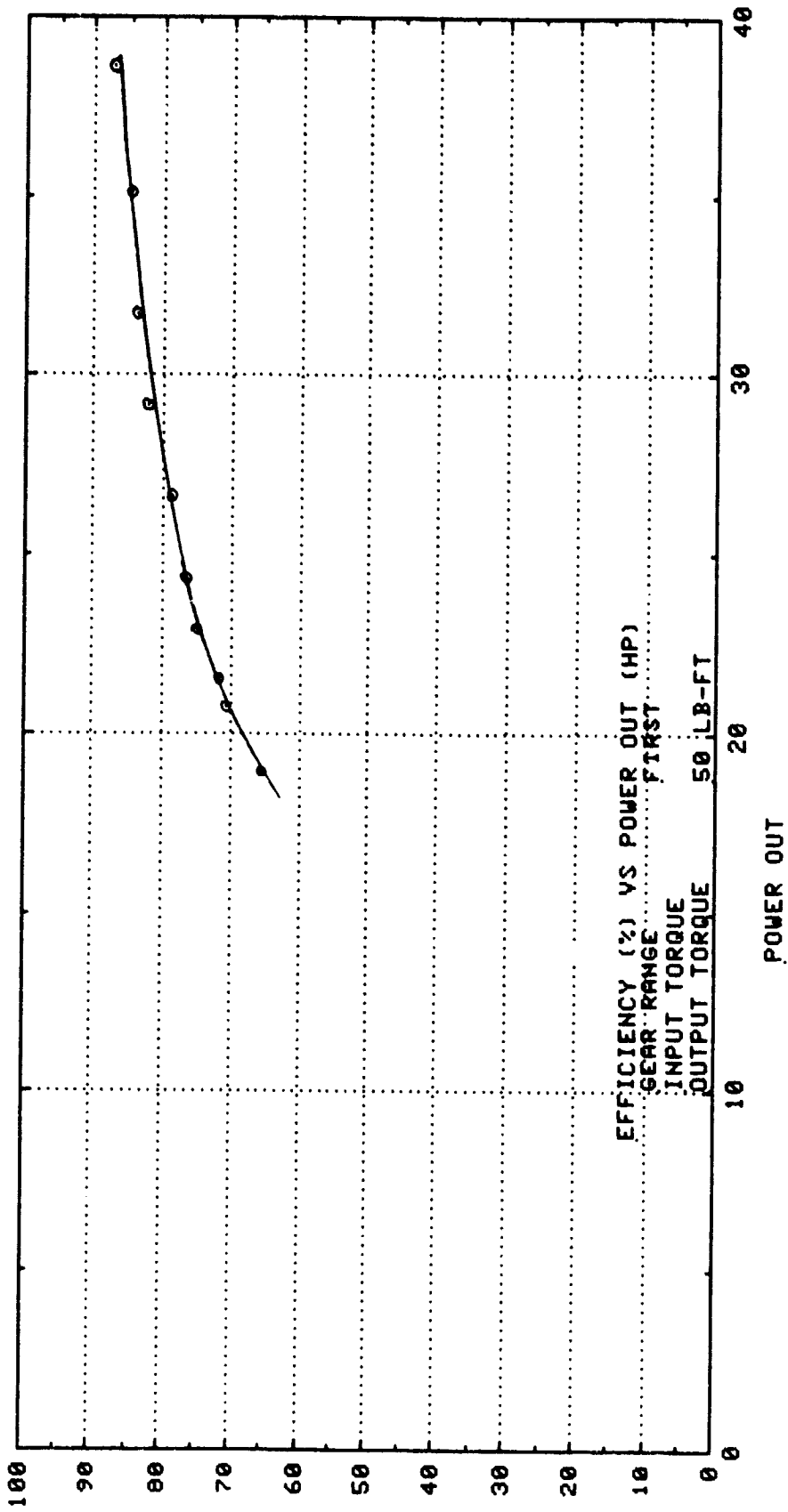

**COAST PERFORMANCE**

**2nd Gear**

**Graphs Contained in This Section**

**Torque Ratio -vs- Output Speed**

**Output Torque -vs- Output Speed**

**Input Speed -vs- Output Speed**

**Efficiency -vs- Output Speed**

**Efficiency -vs- Power Out**

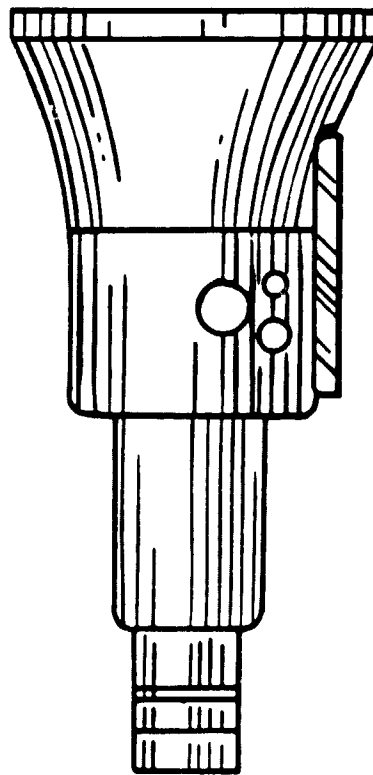

**Torque In**

**Speed In**

**Torque Out**

**Speed Out**

---

**Coast Performance Tests**



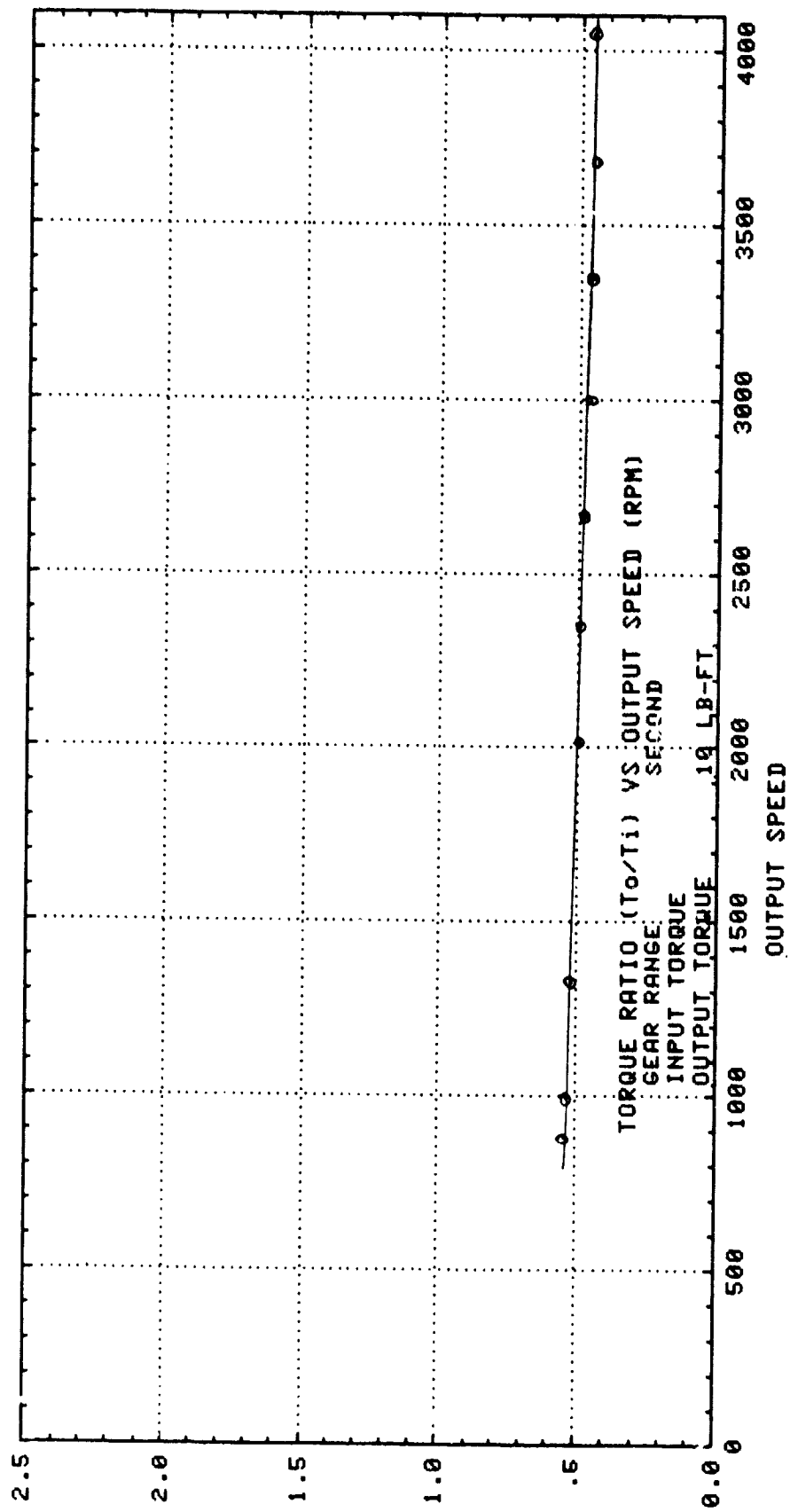

TORQUE RATIO

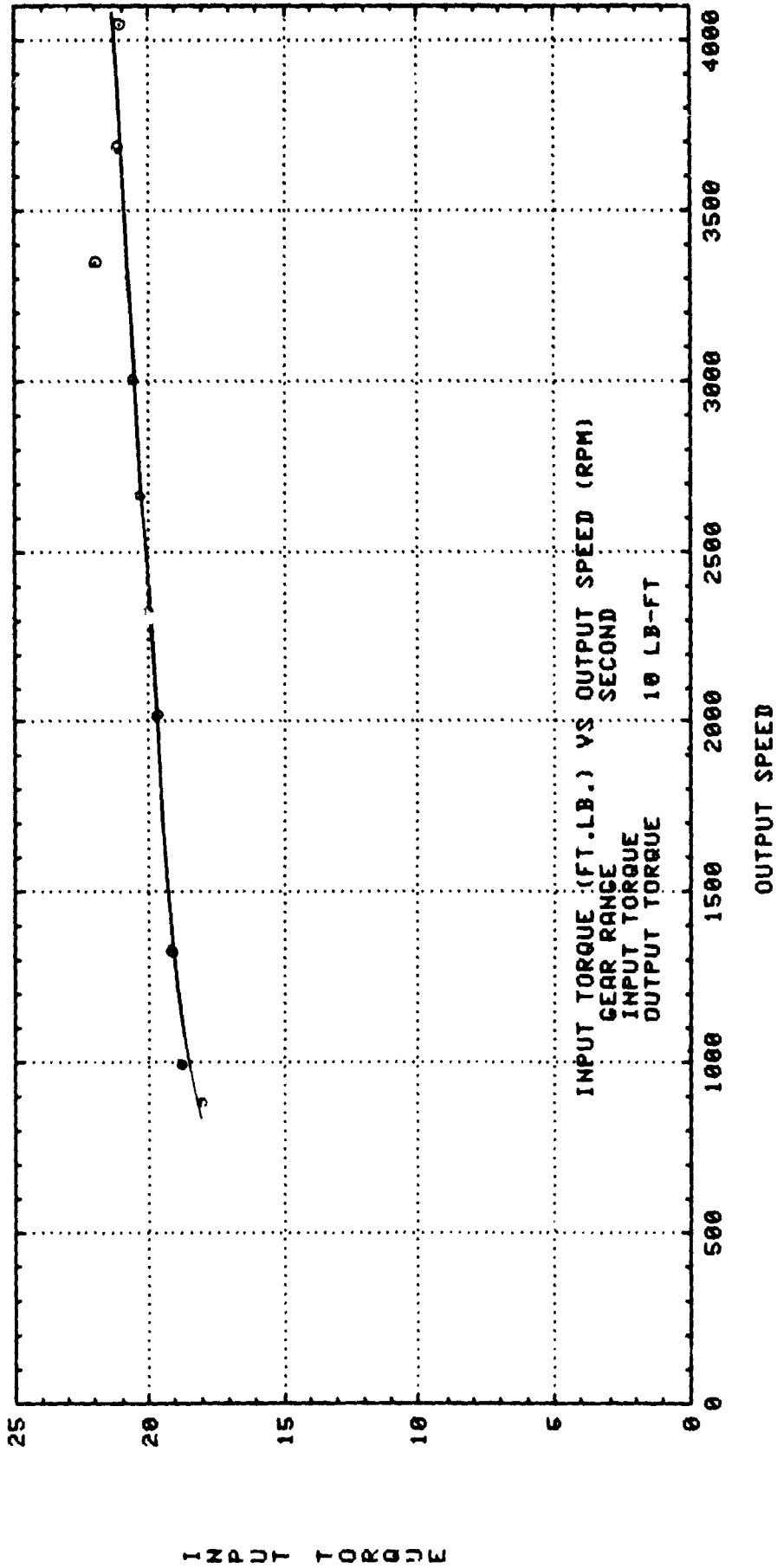

INPUT TORQUE

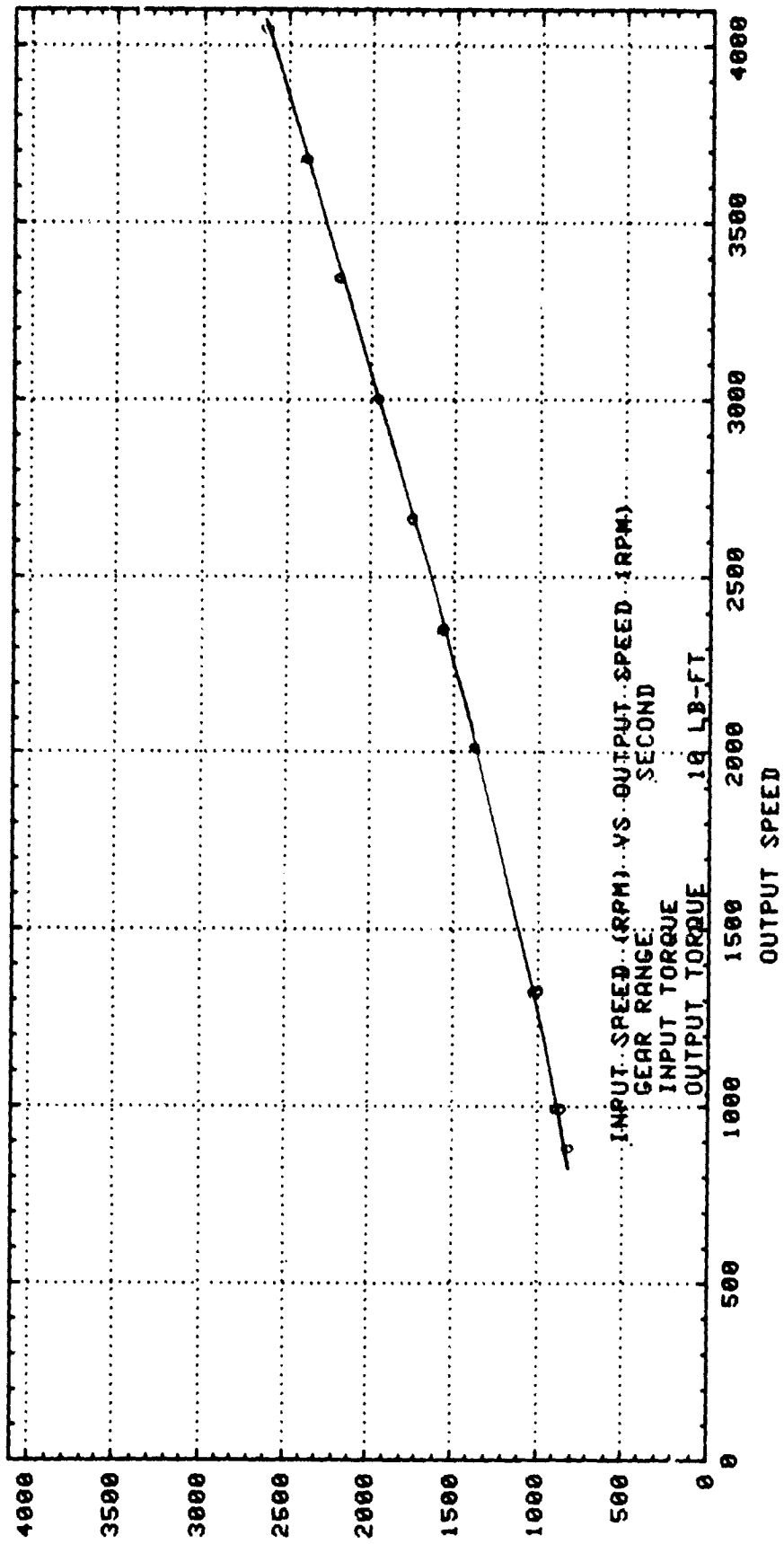

INPUT SPEED

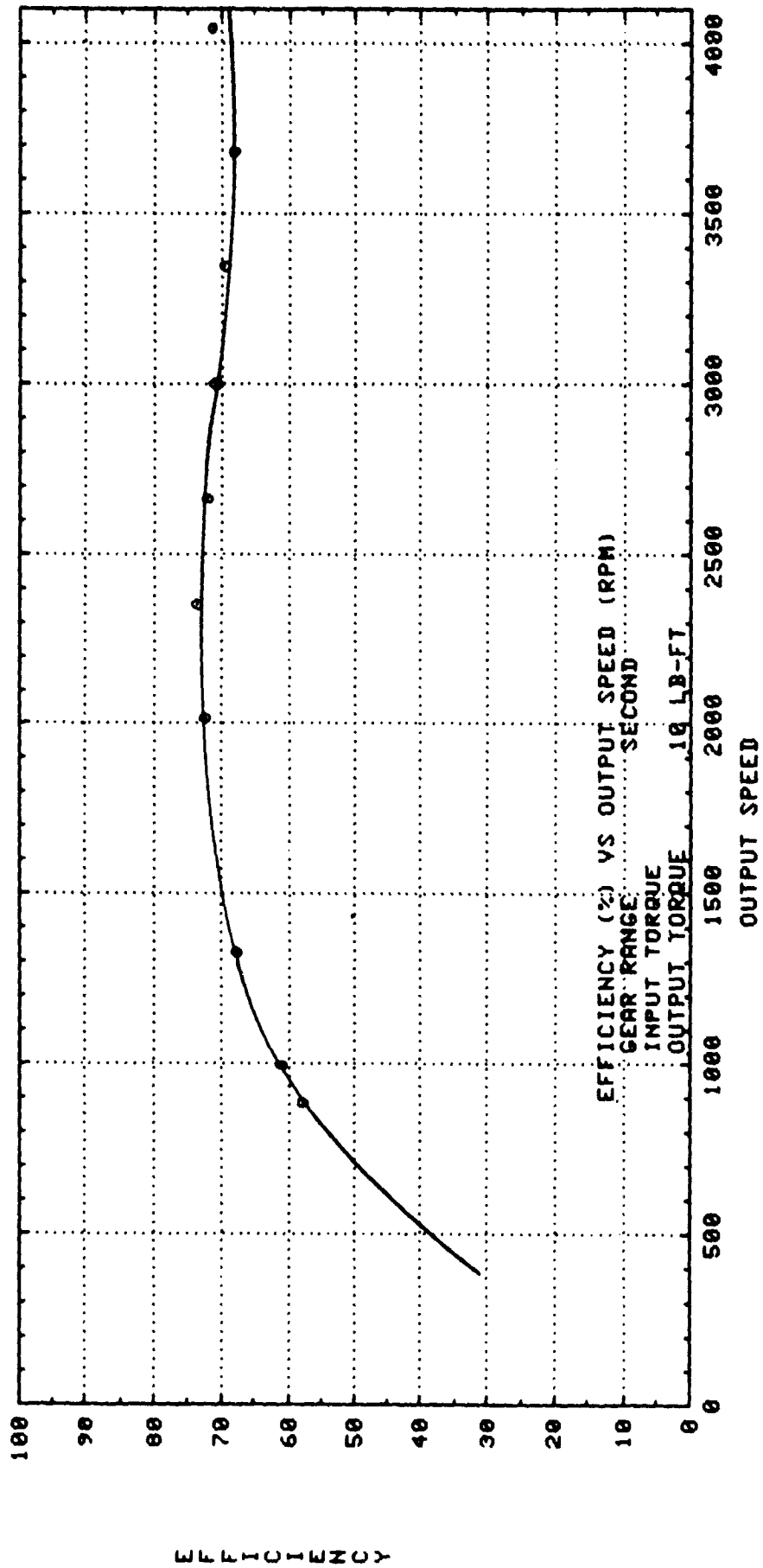

EFFICIENCY

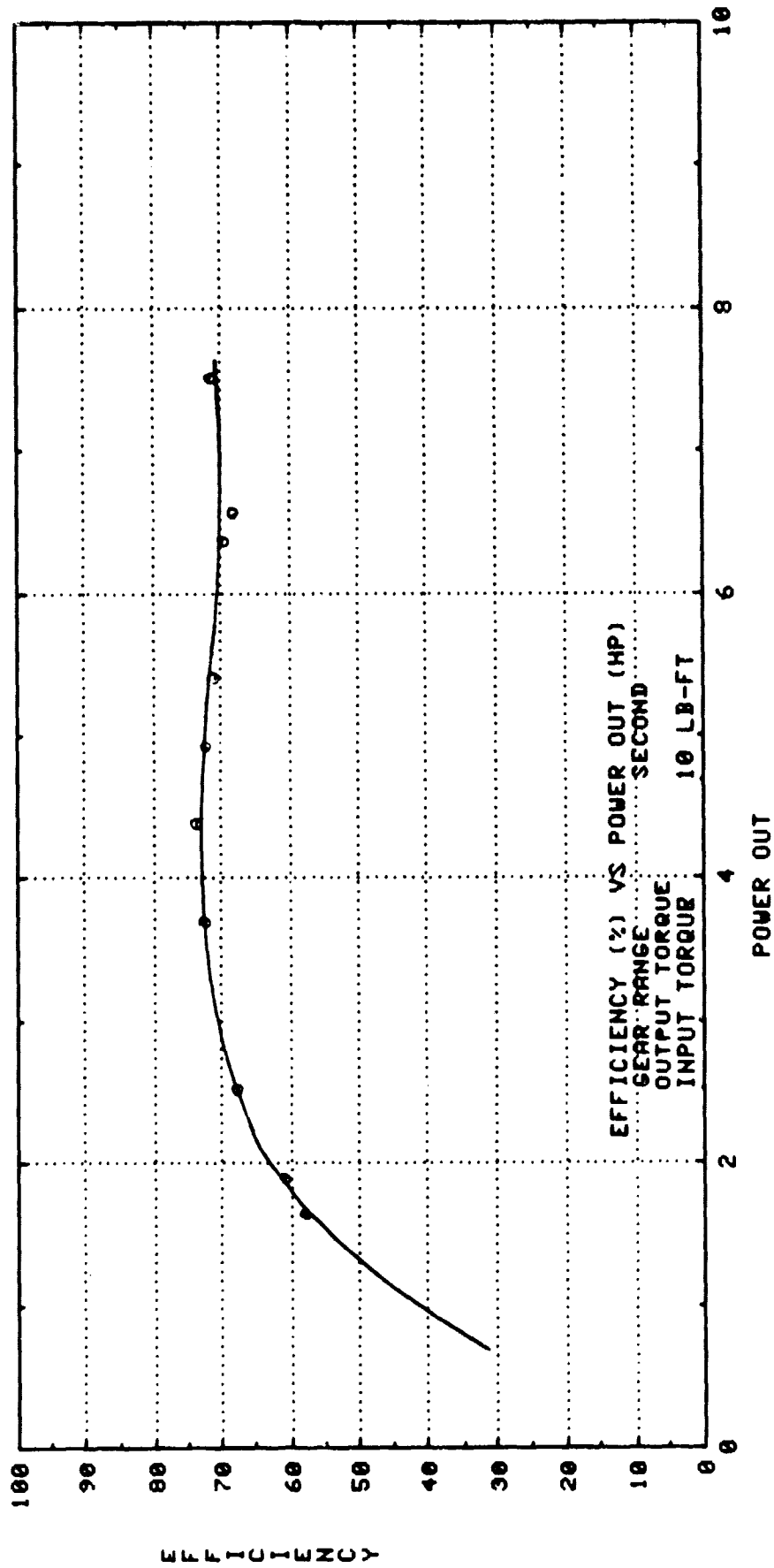

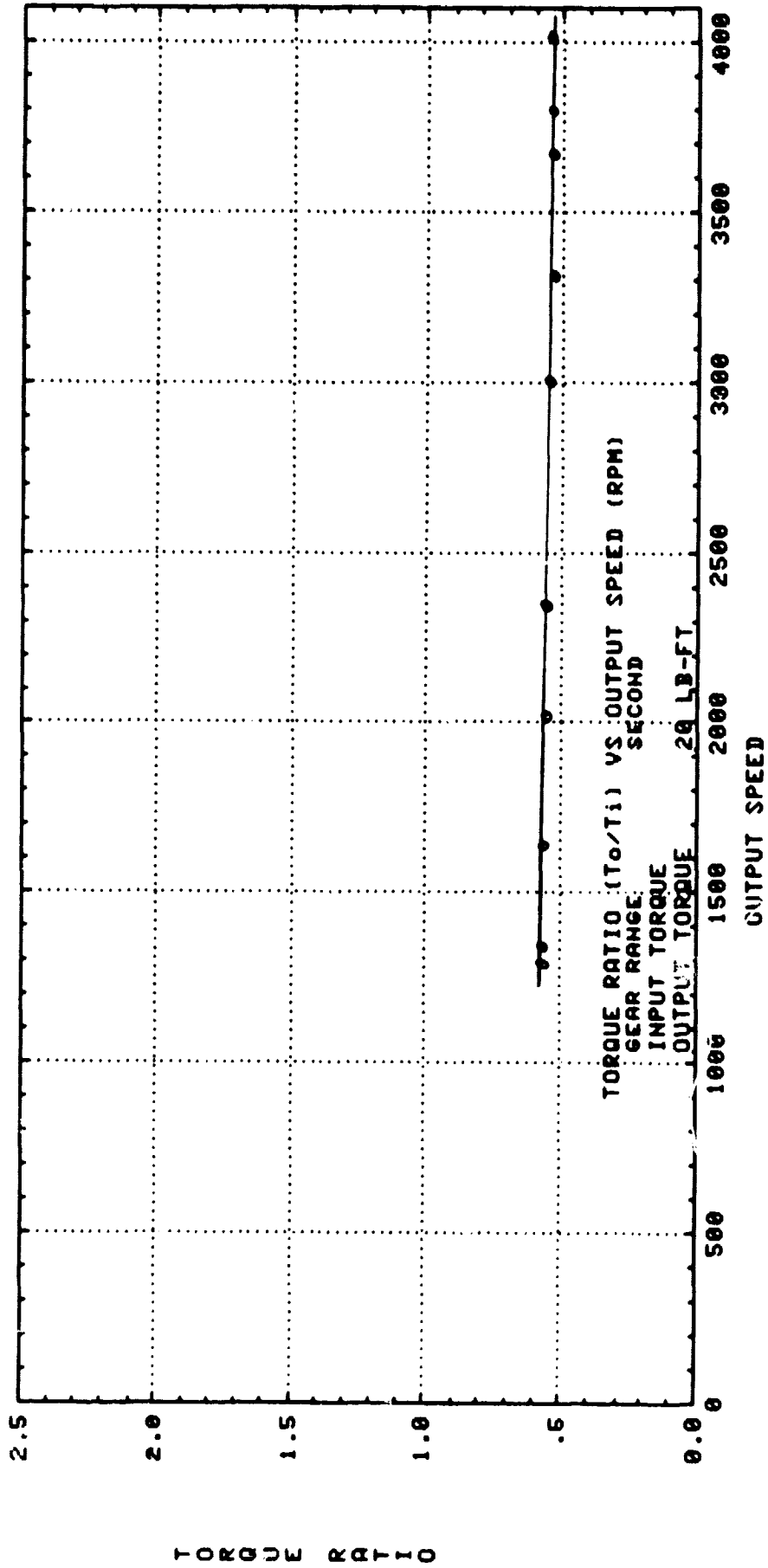

TORQUE RATIO

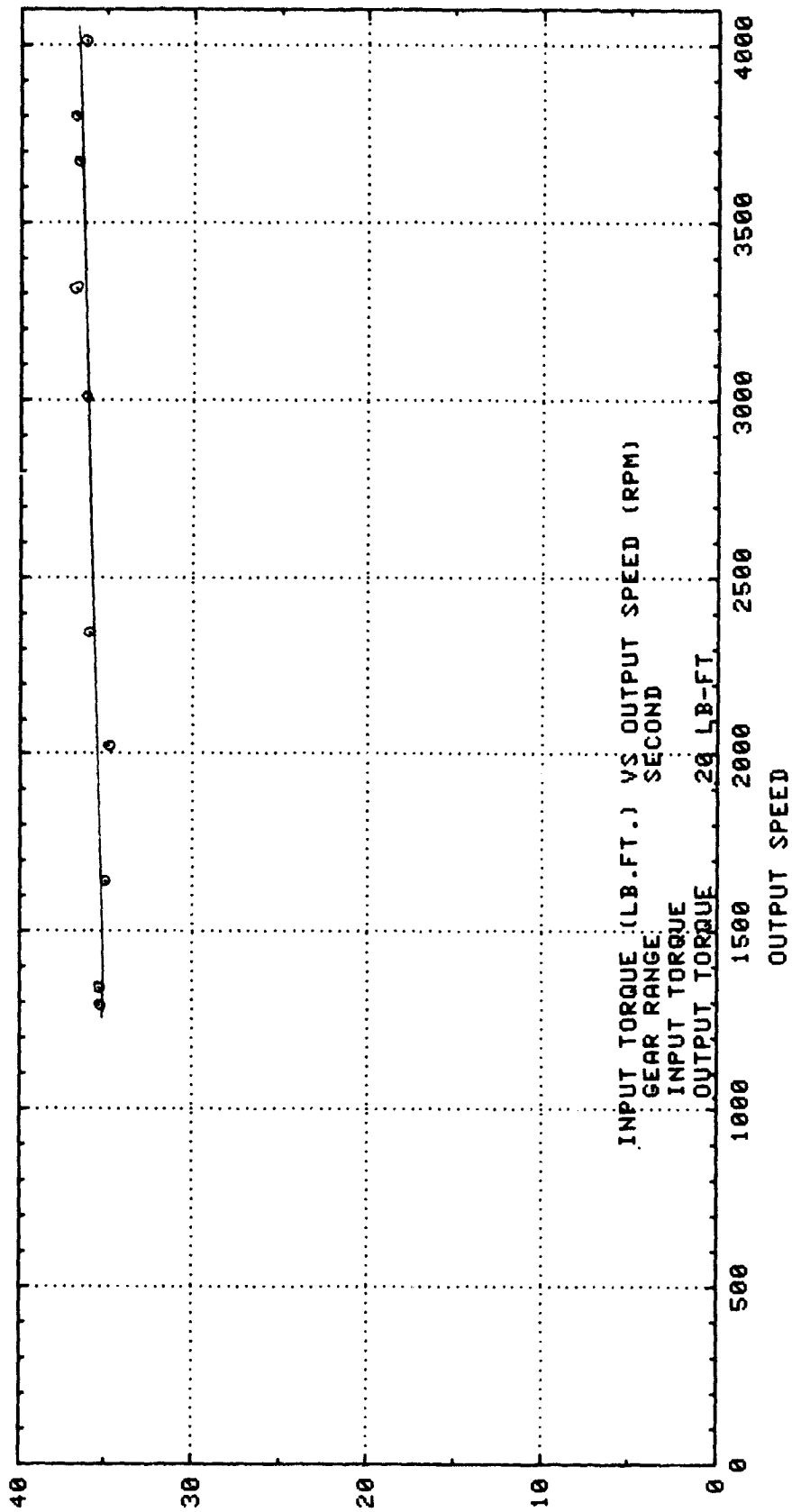

INPUT TORQUE

INPUT SPEED

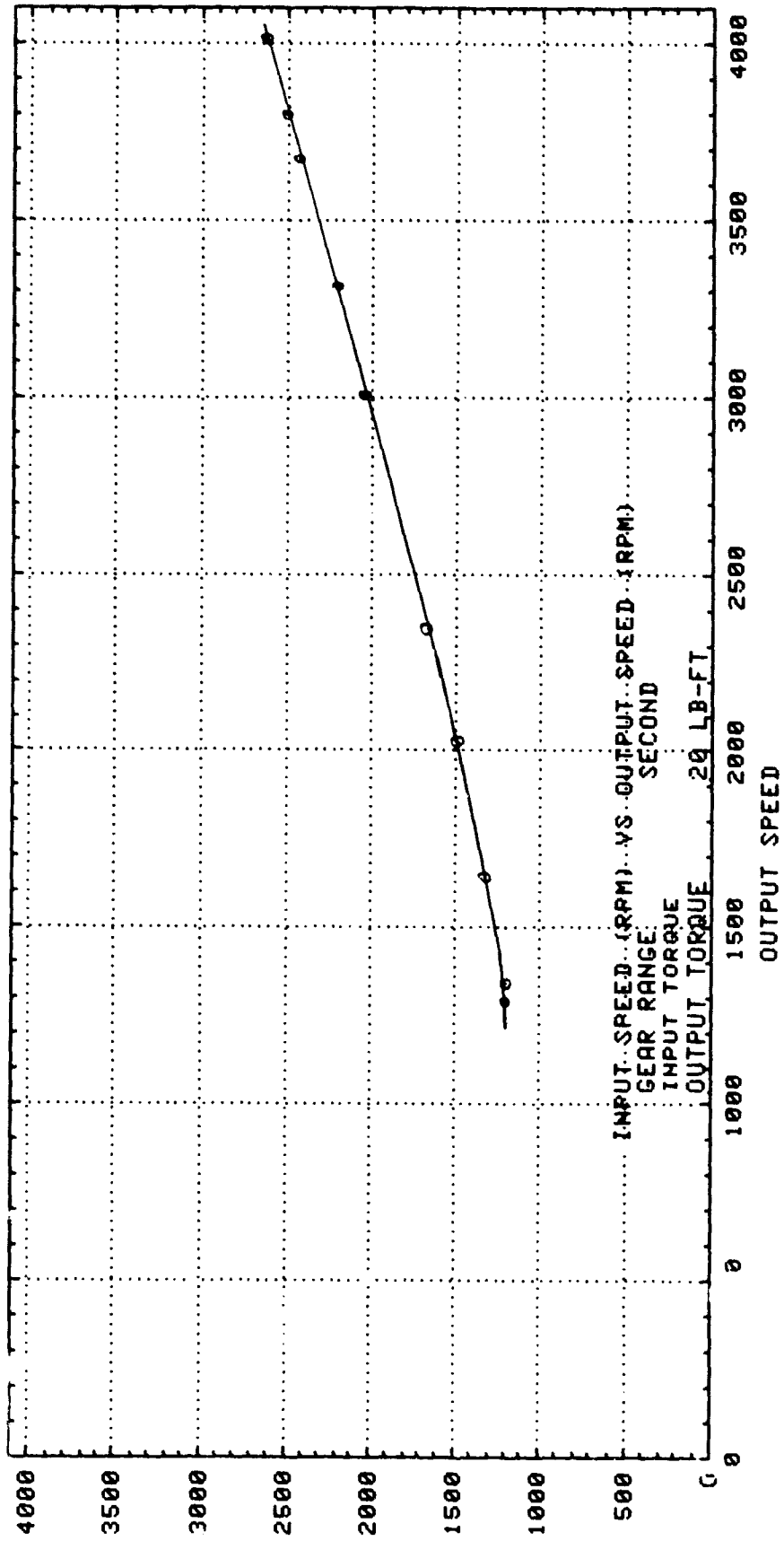



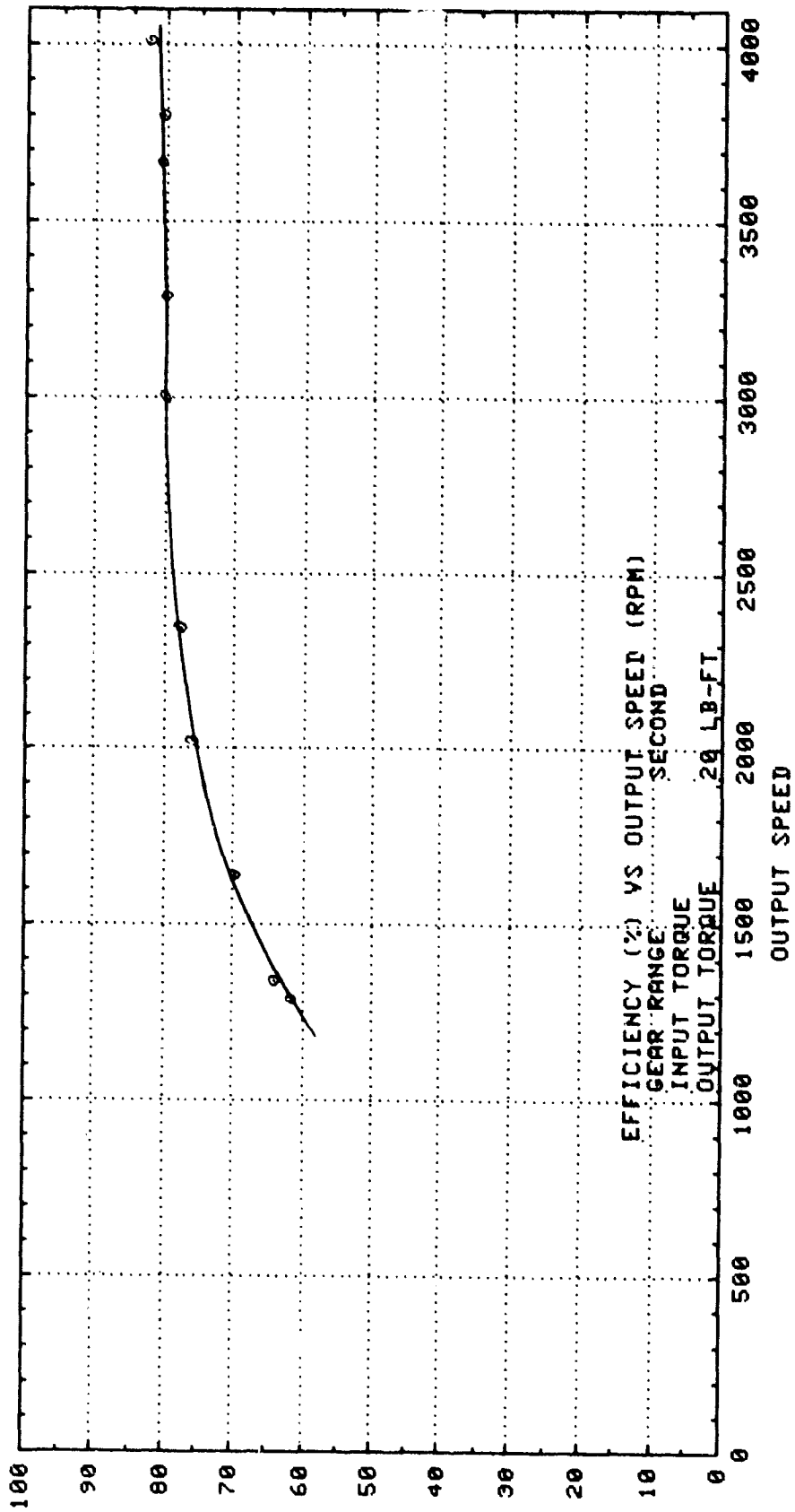

EFFICIENCY

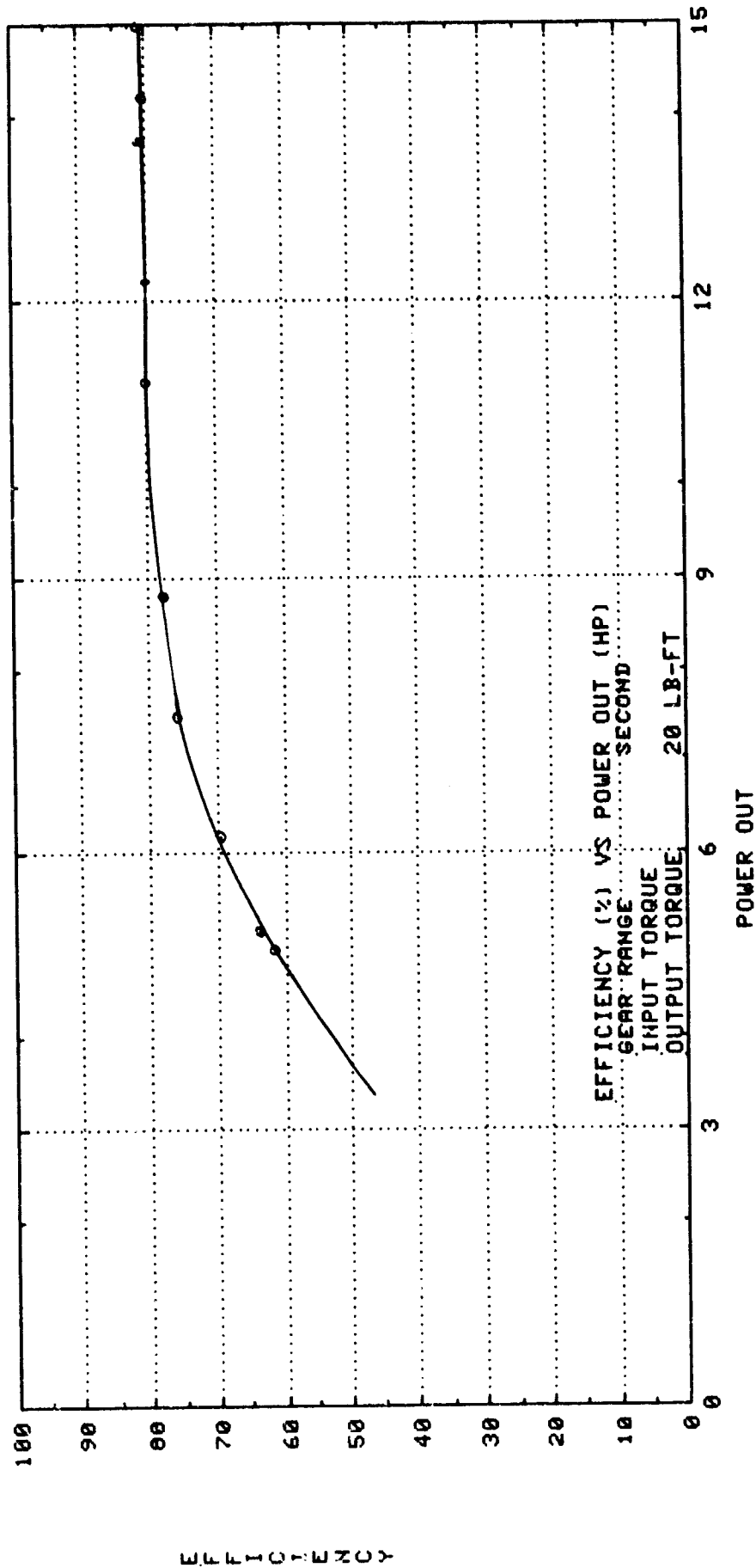

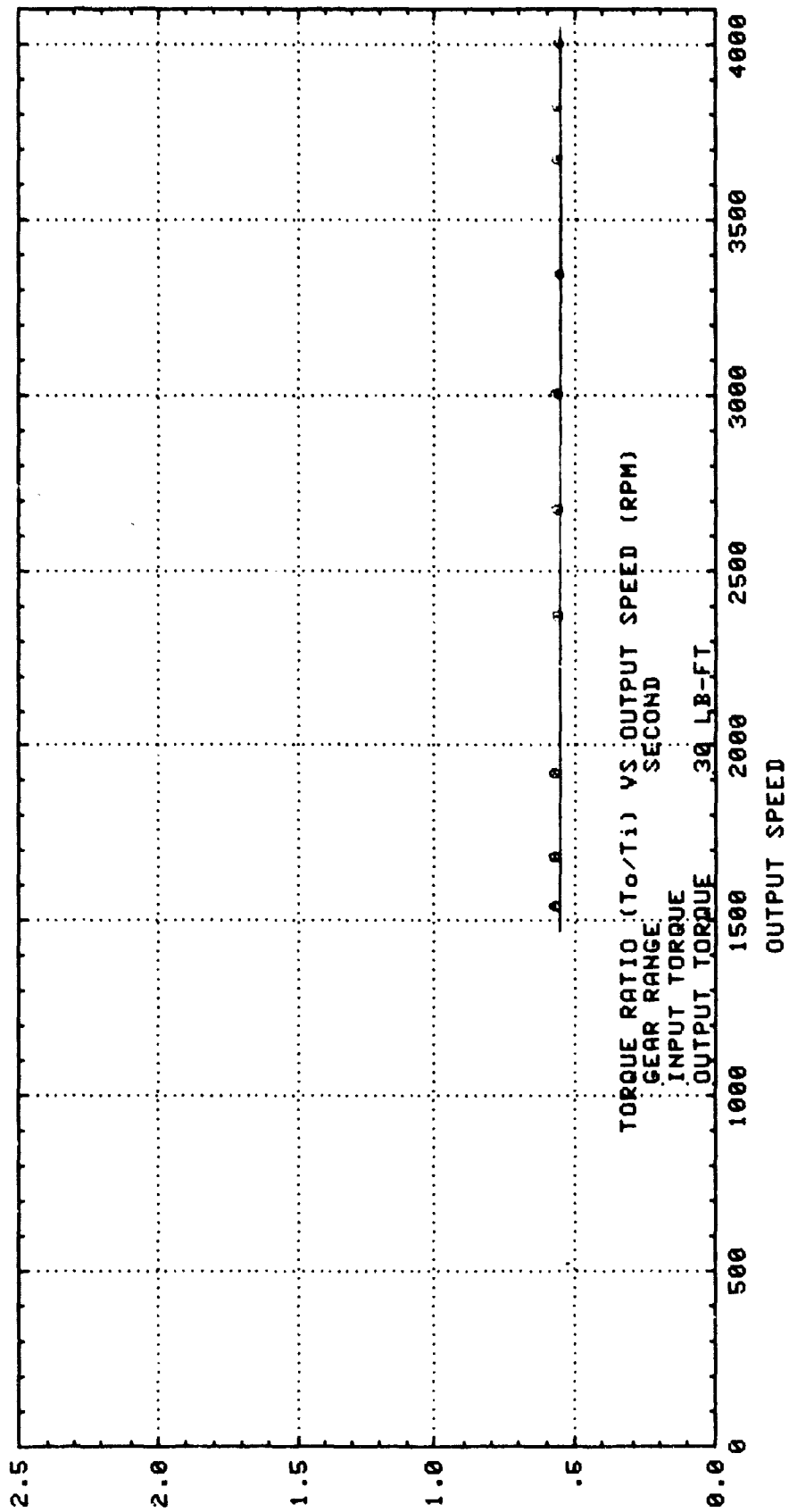

TORQUE RATIO

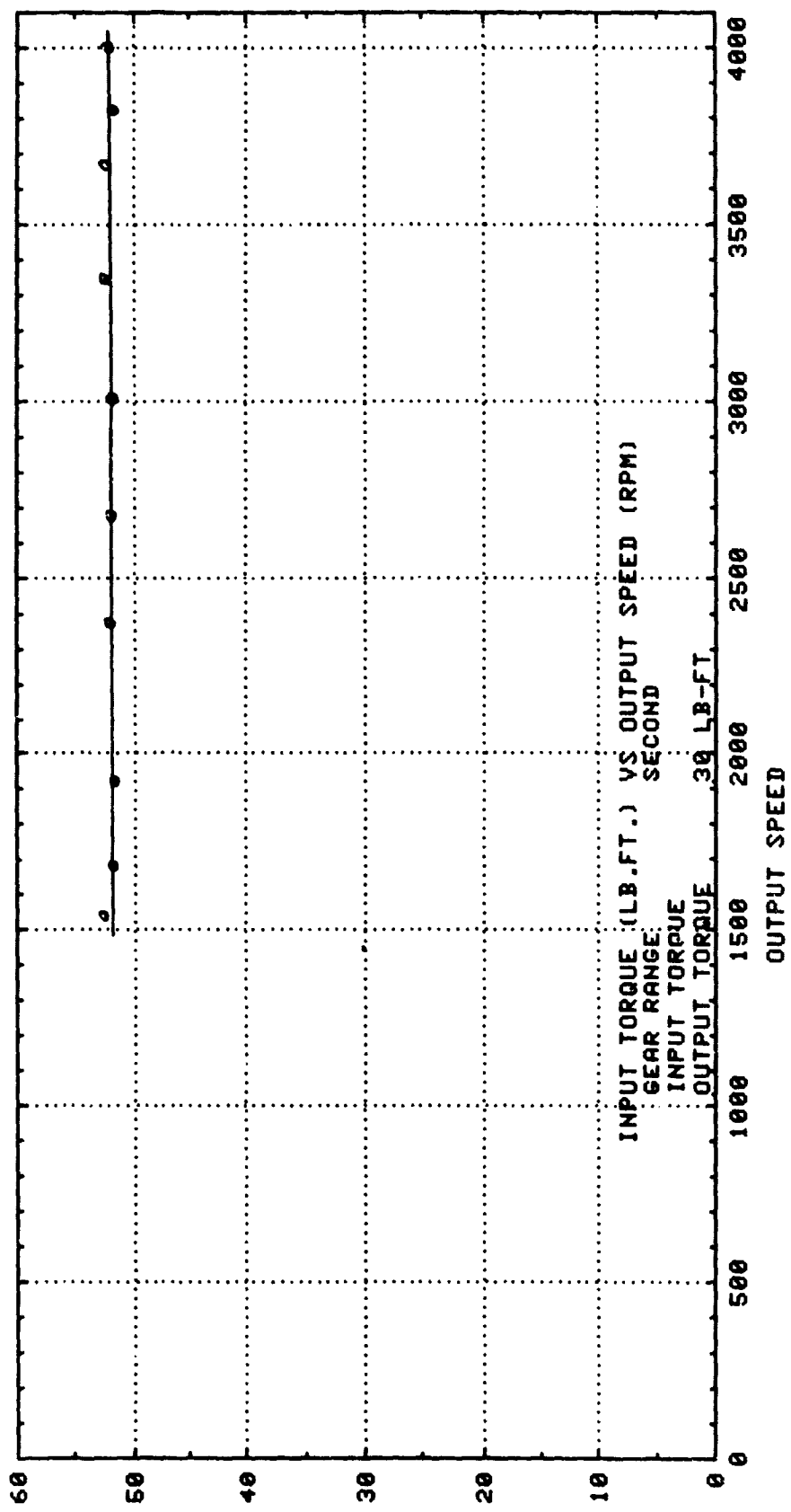

INPUT TORQUE

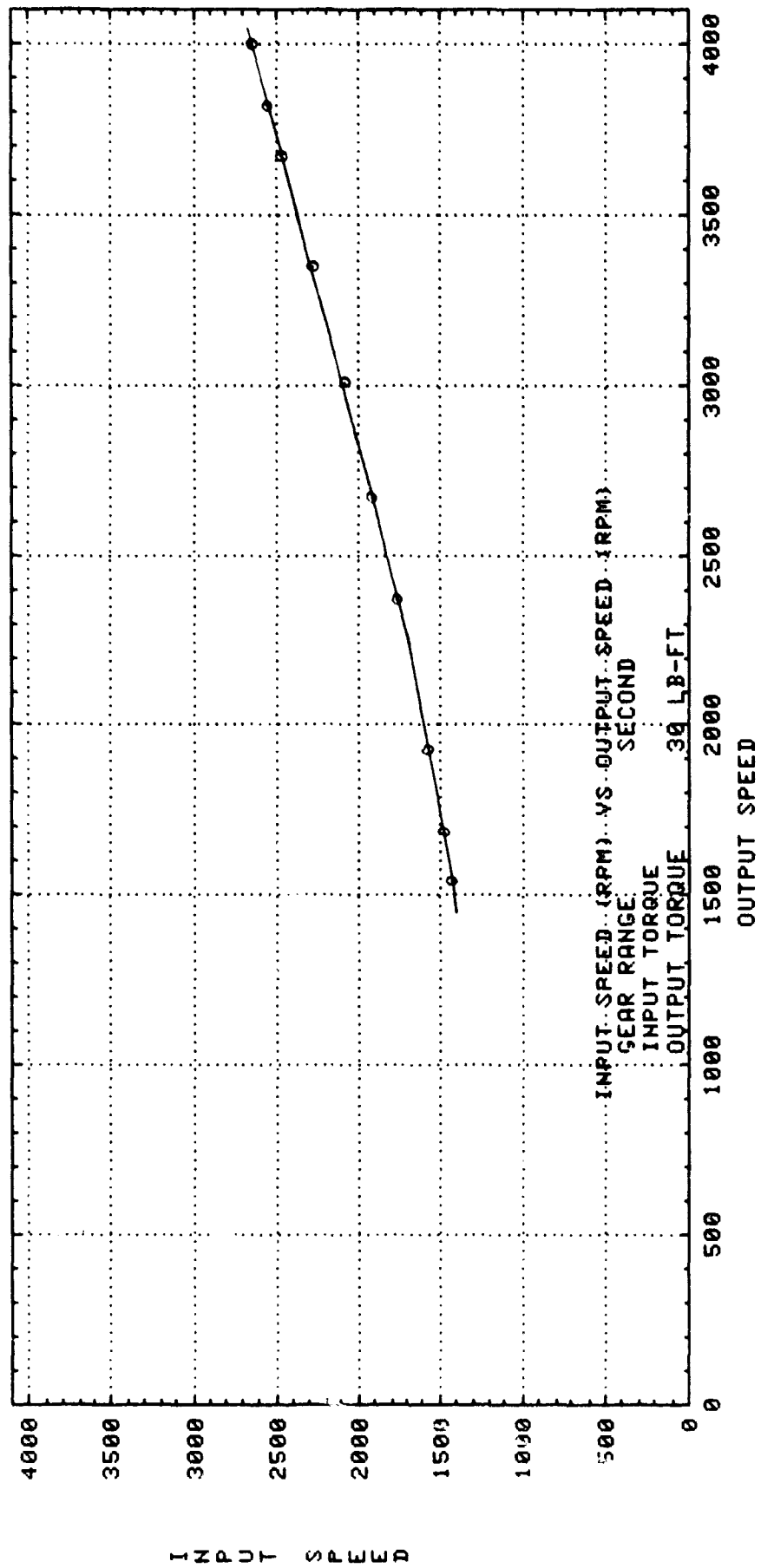

EFFICIENCY

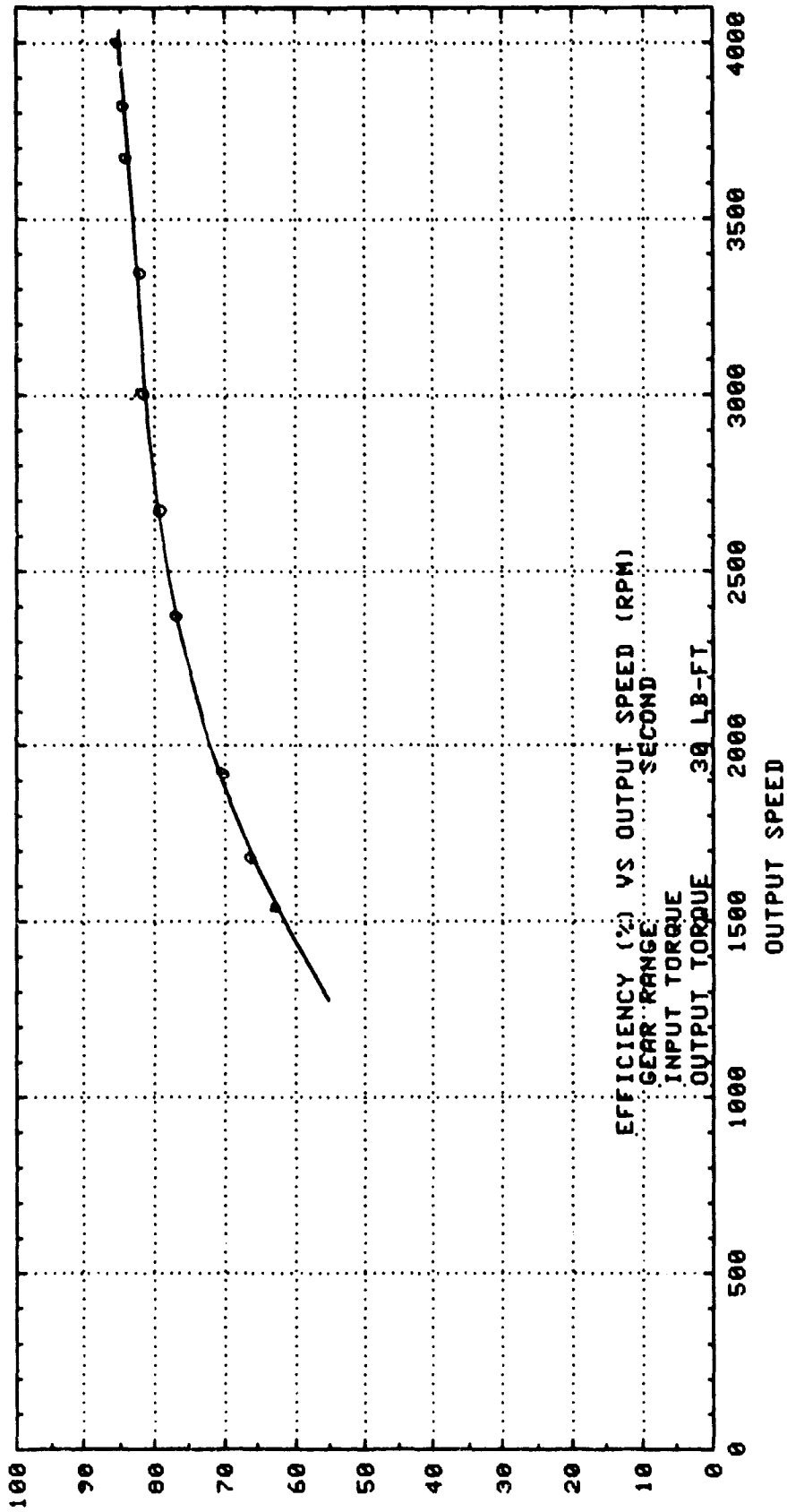

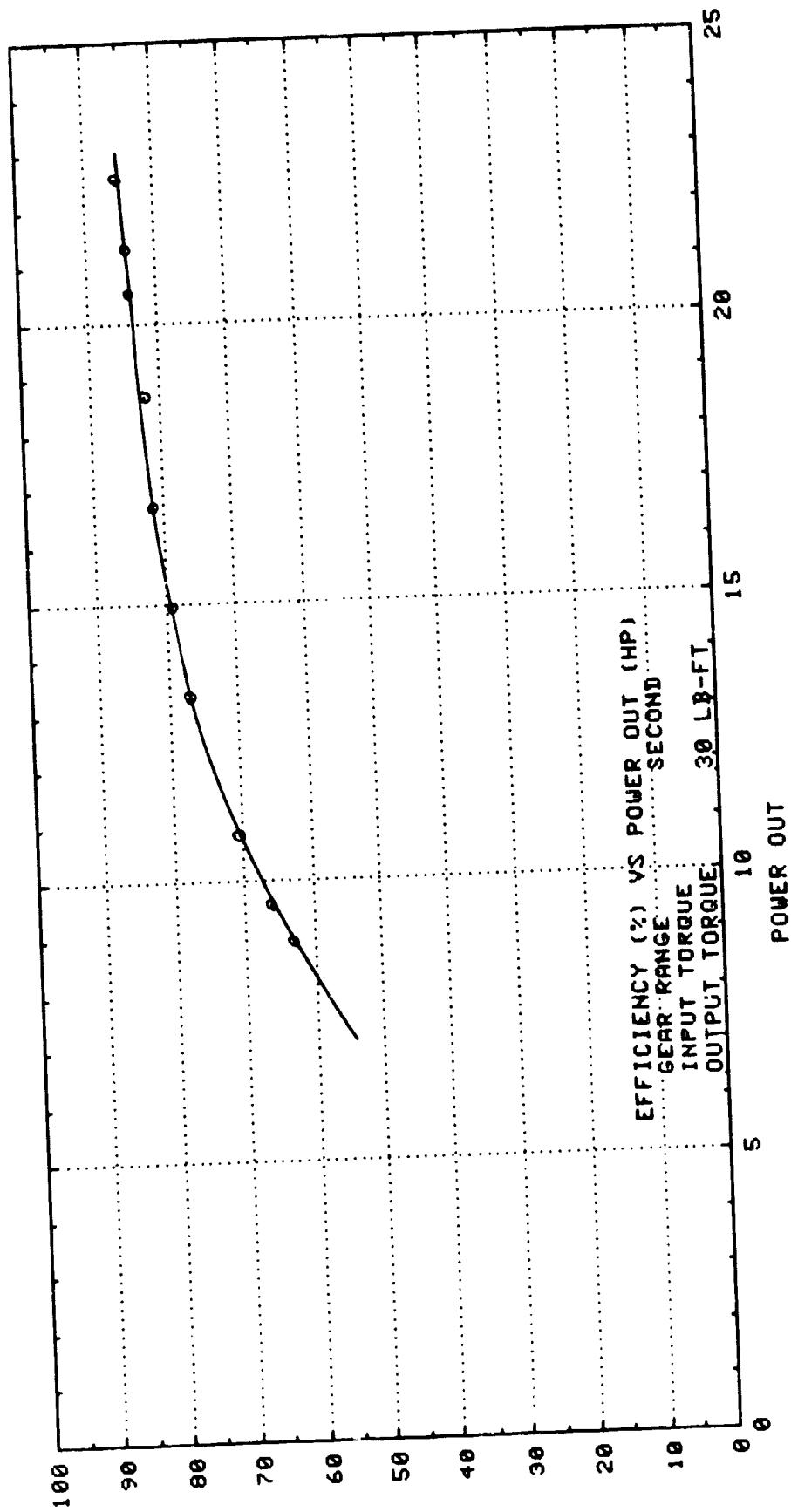

EFFICIENCY

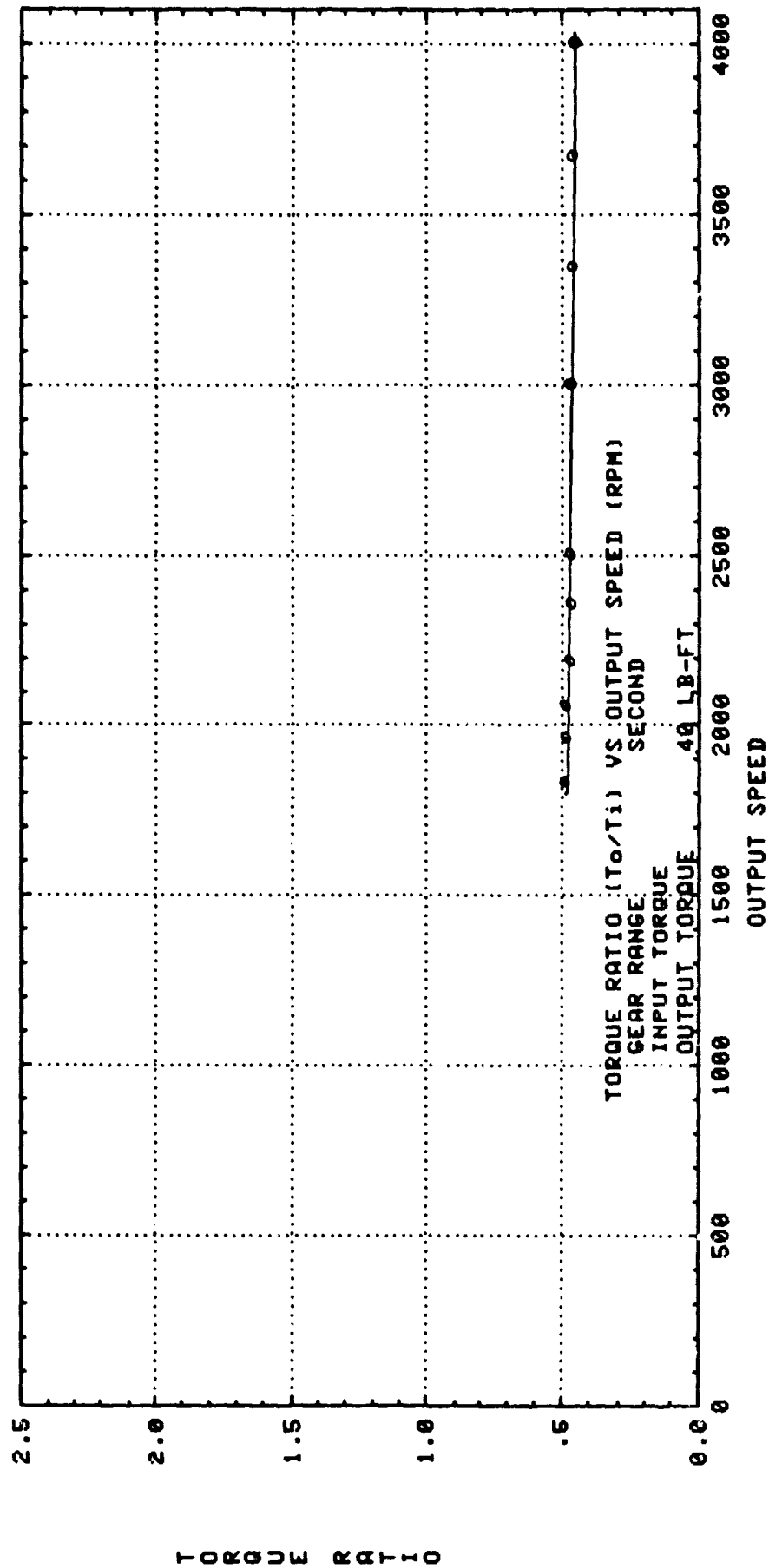

TORQUE RATIO



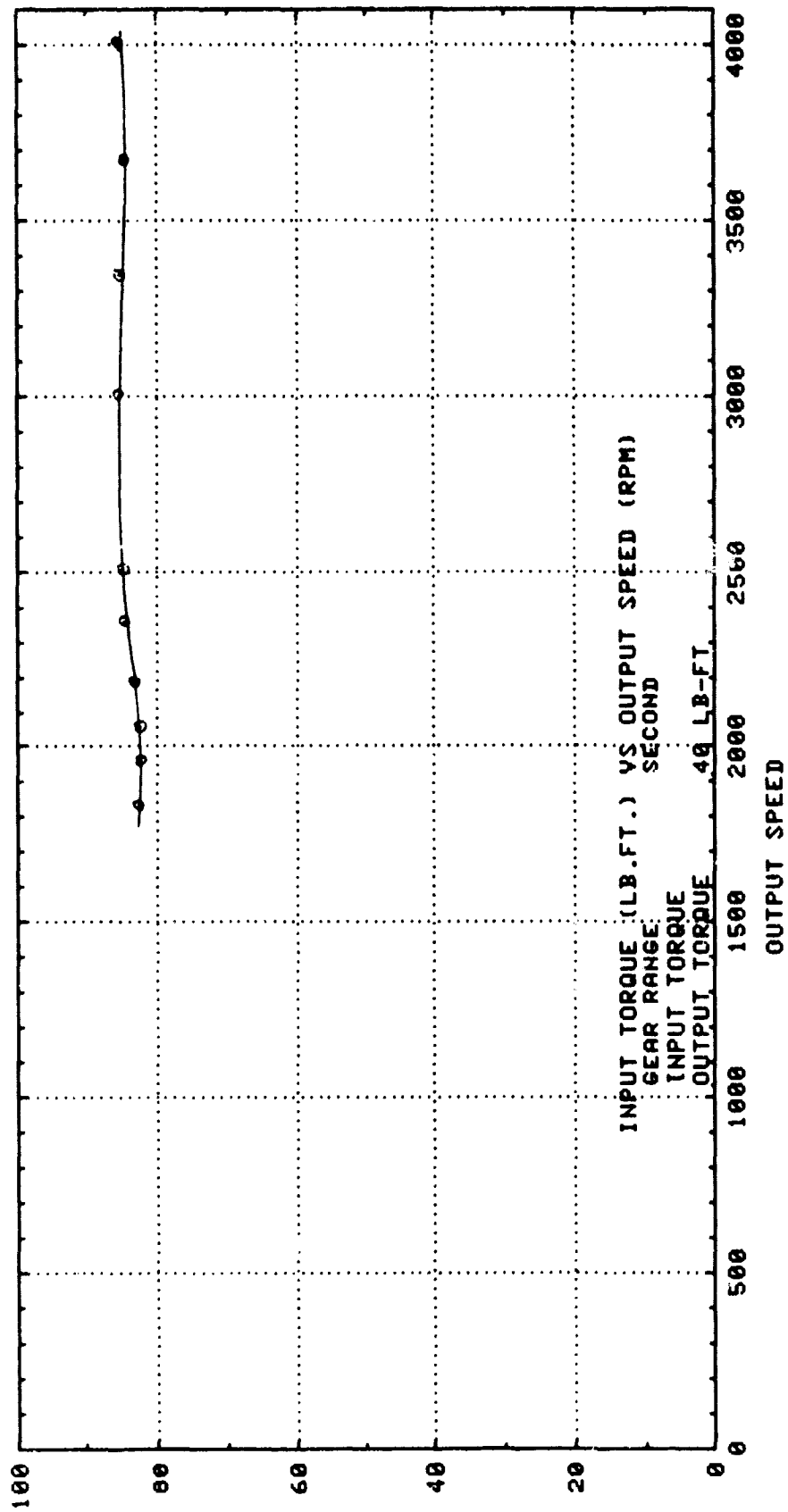

INPUT TORQUE

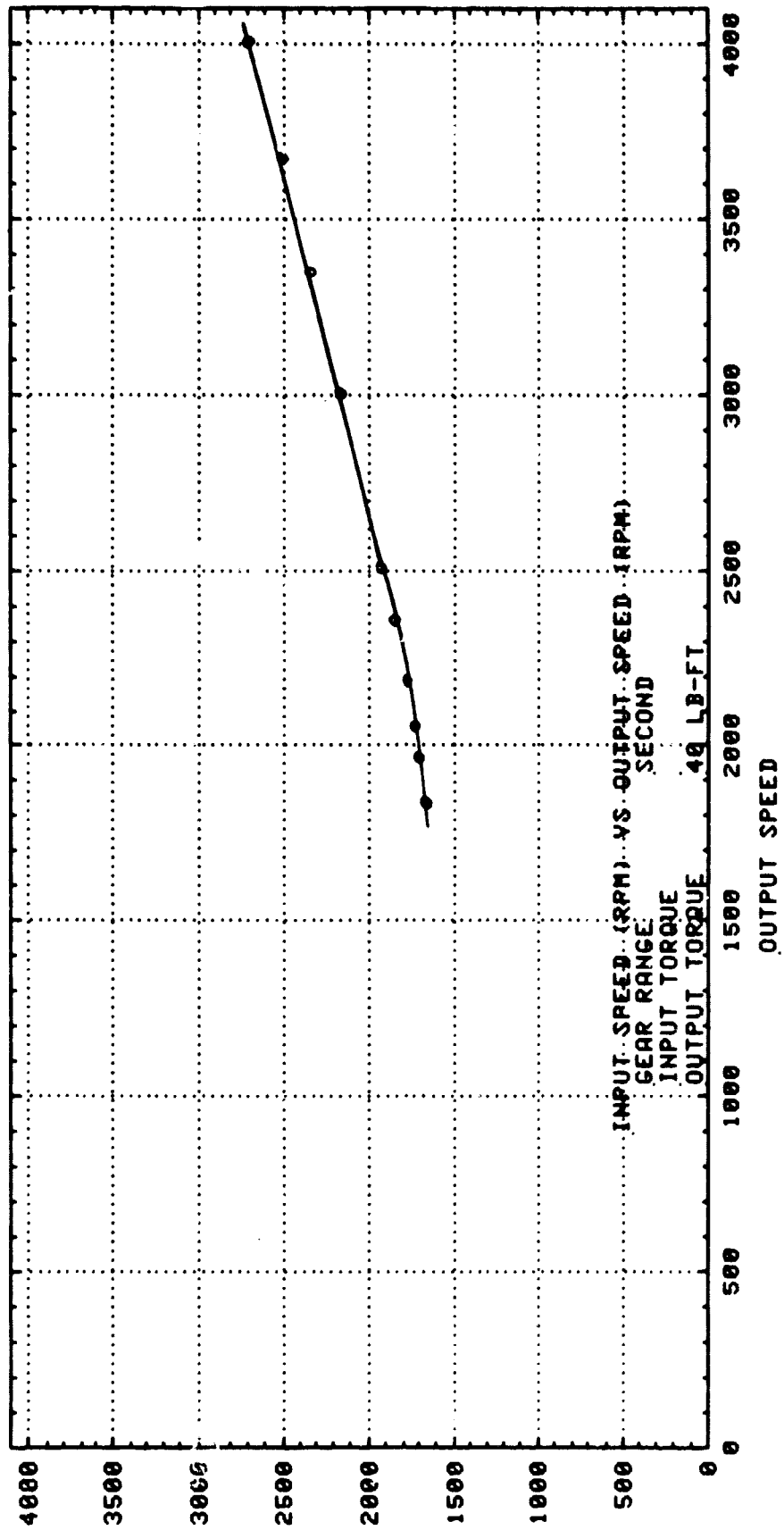

INPUT SPEED

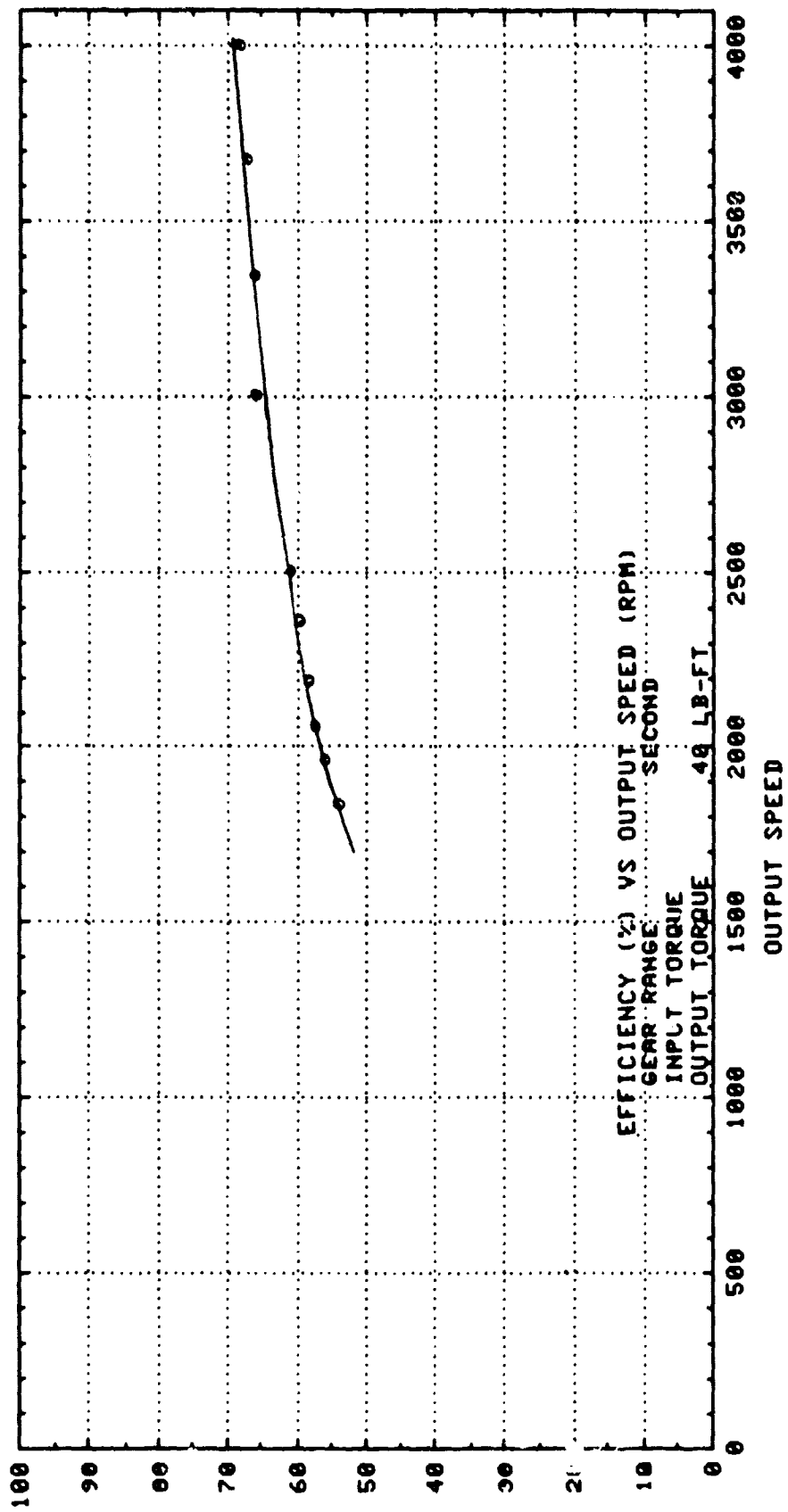

EFFICIENCY

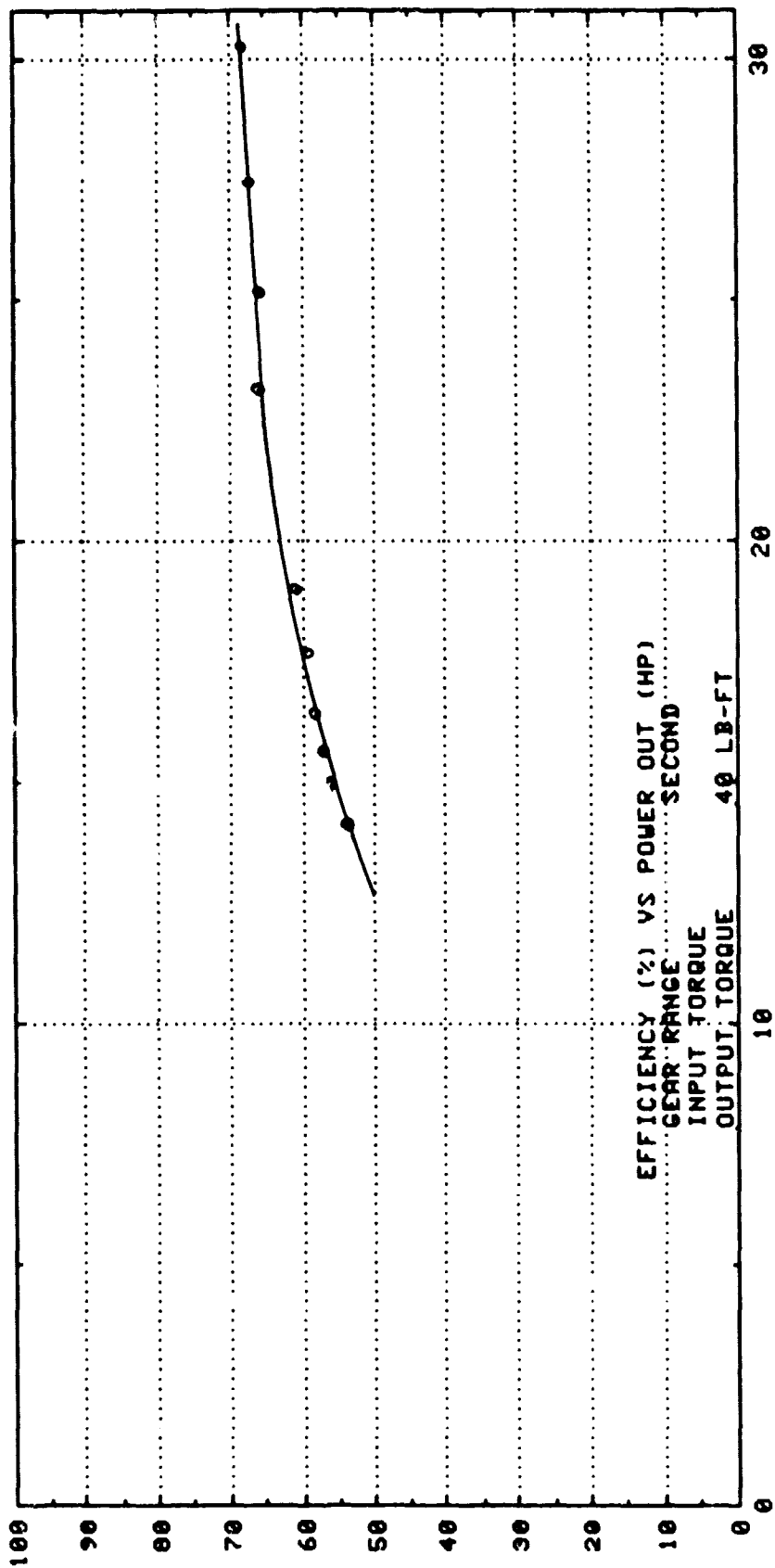

EFFICIENCY

CA

TORQUE RATIO

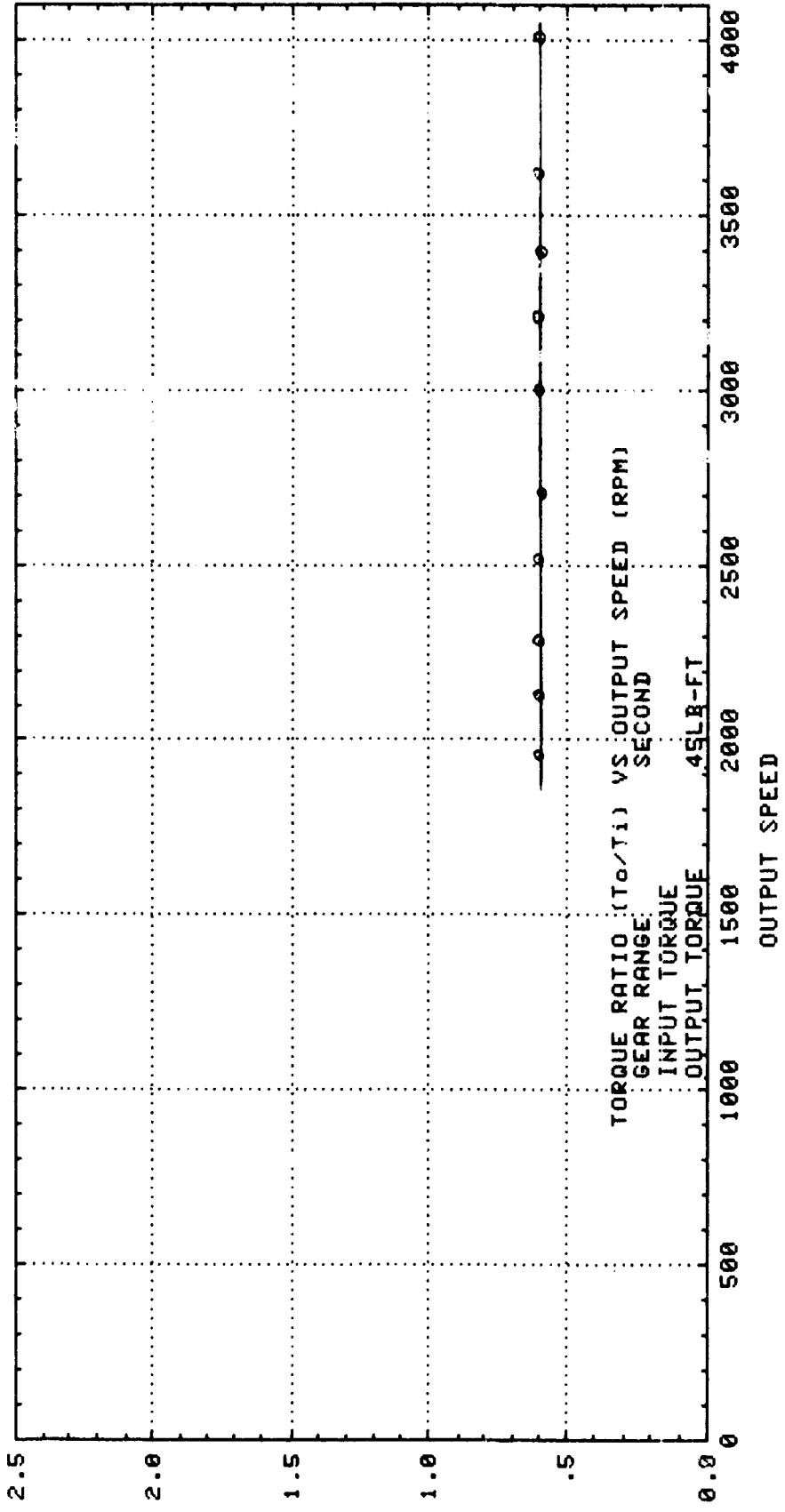

INPUT TORQUE

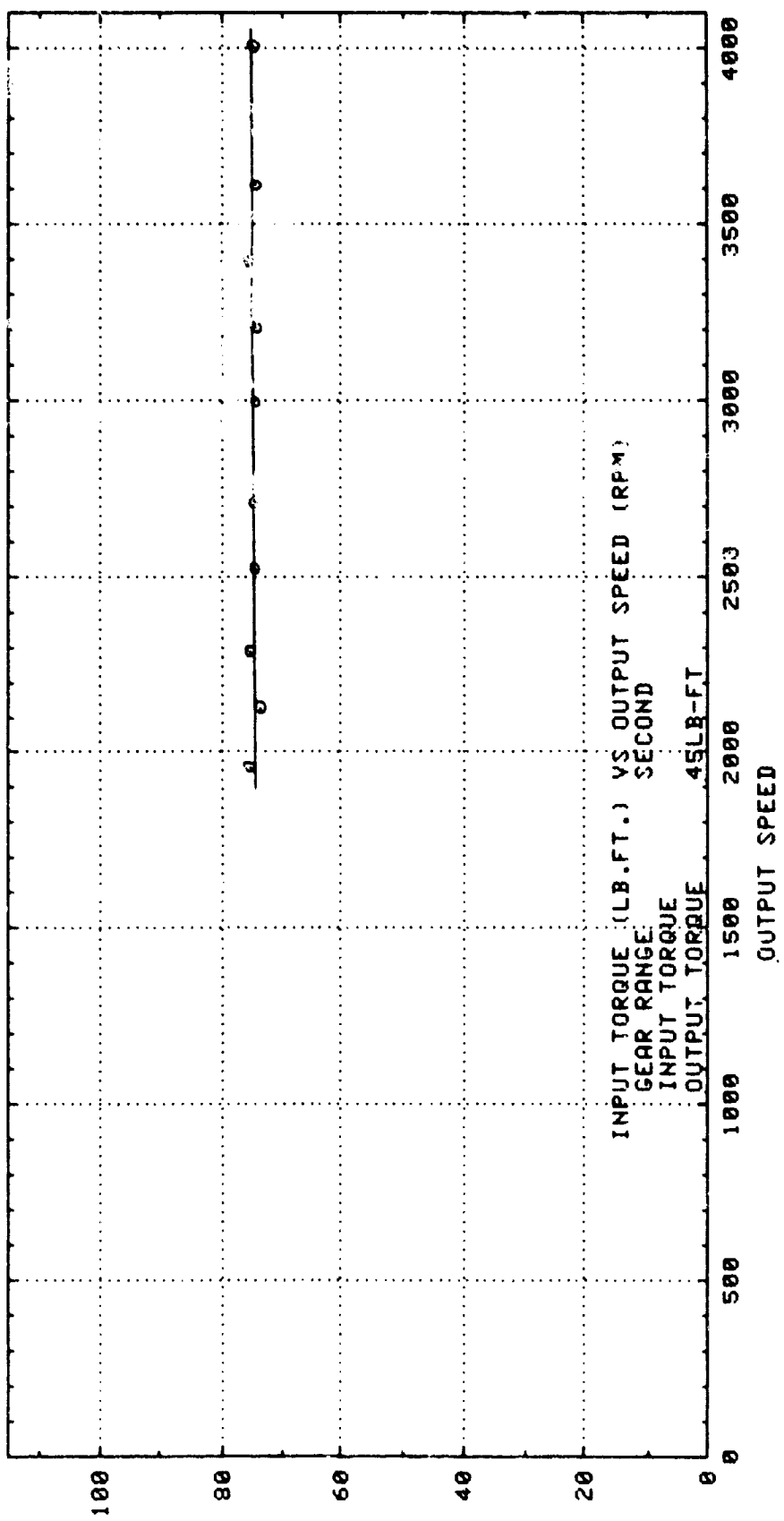

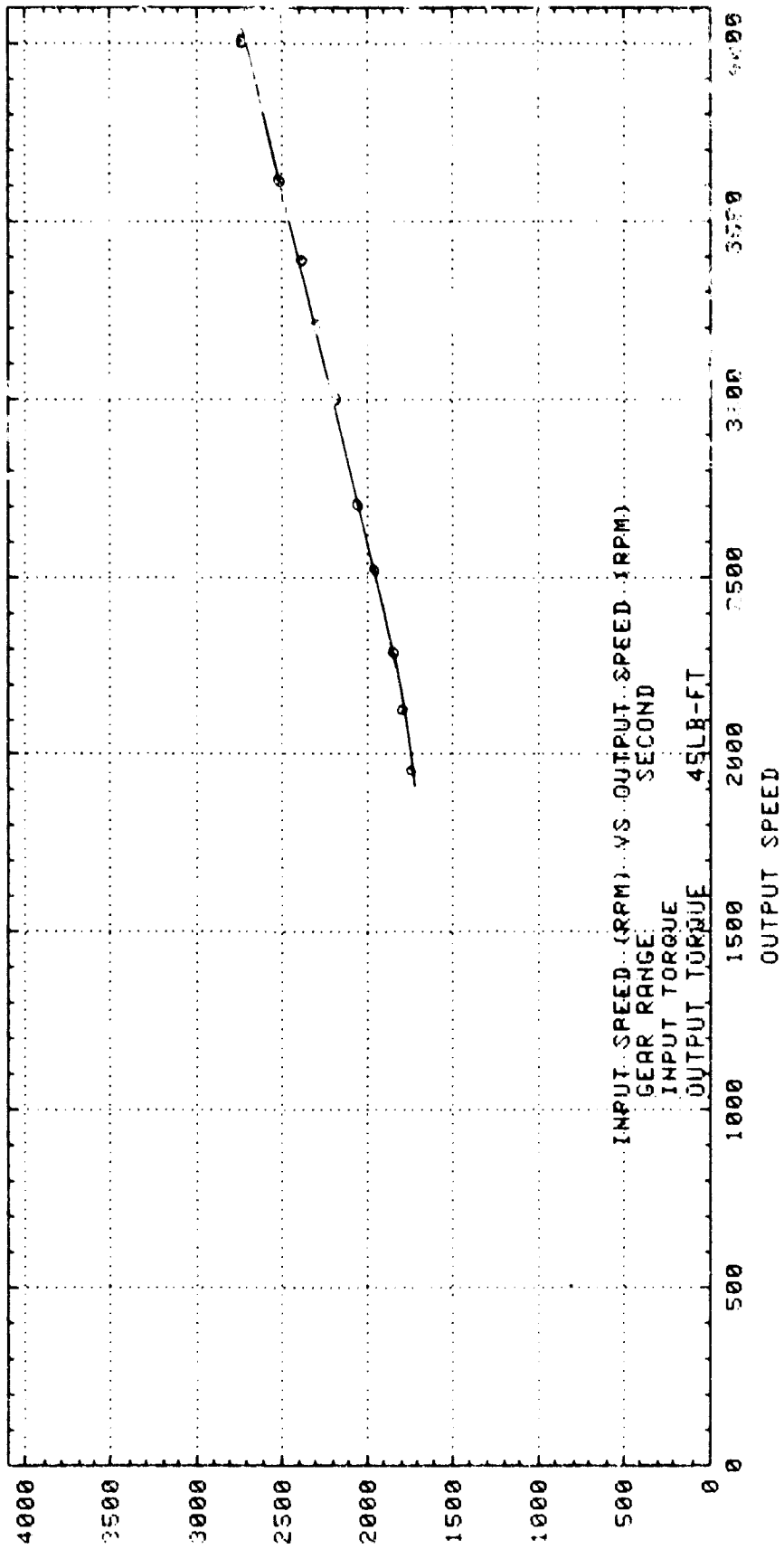

EFFICIENCY

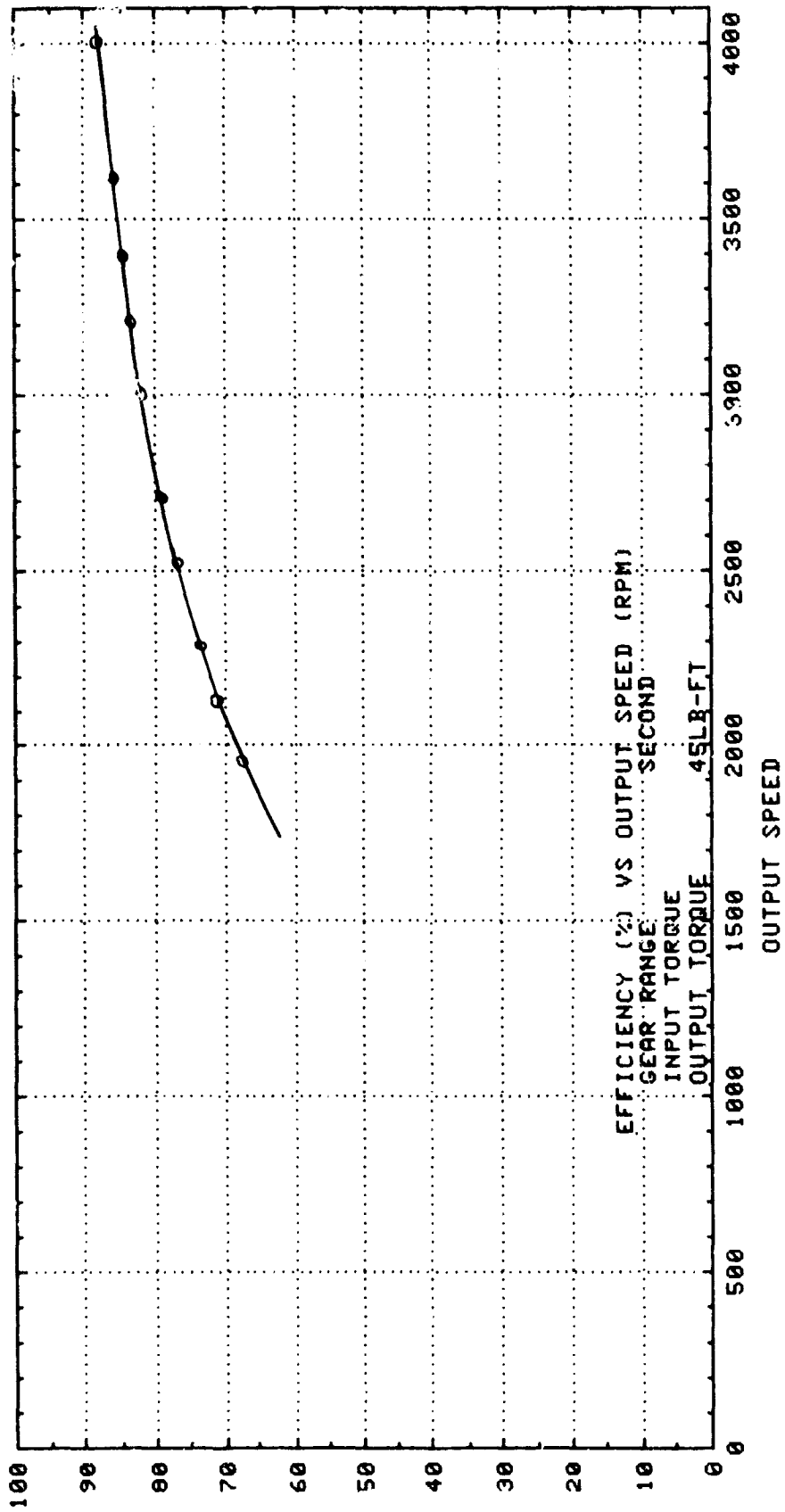



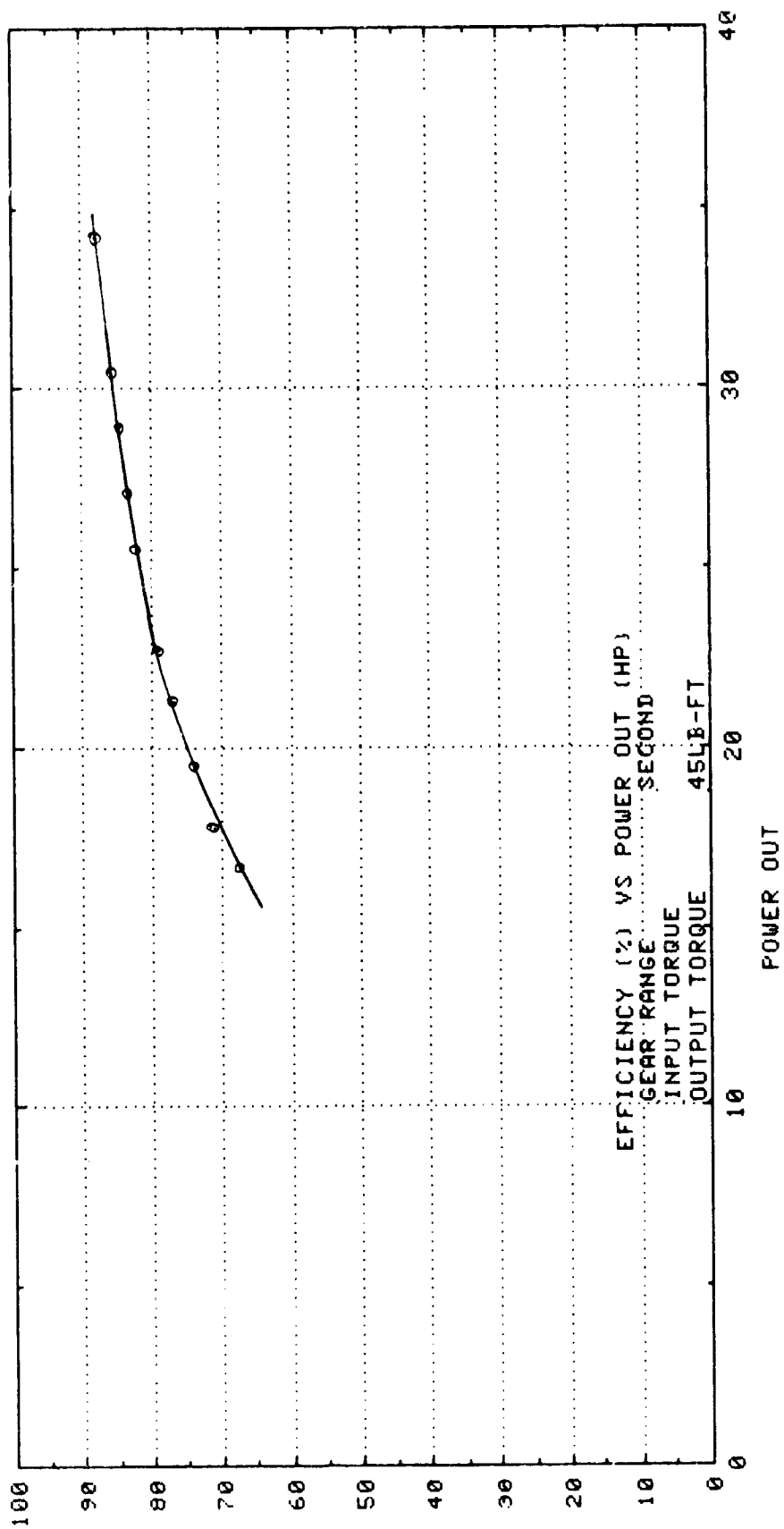

EFFICIENCY

TORQUE RATIO

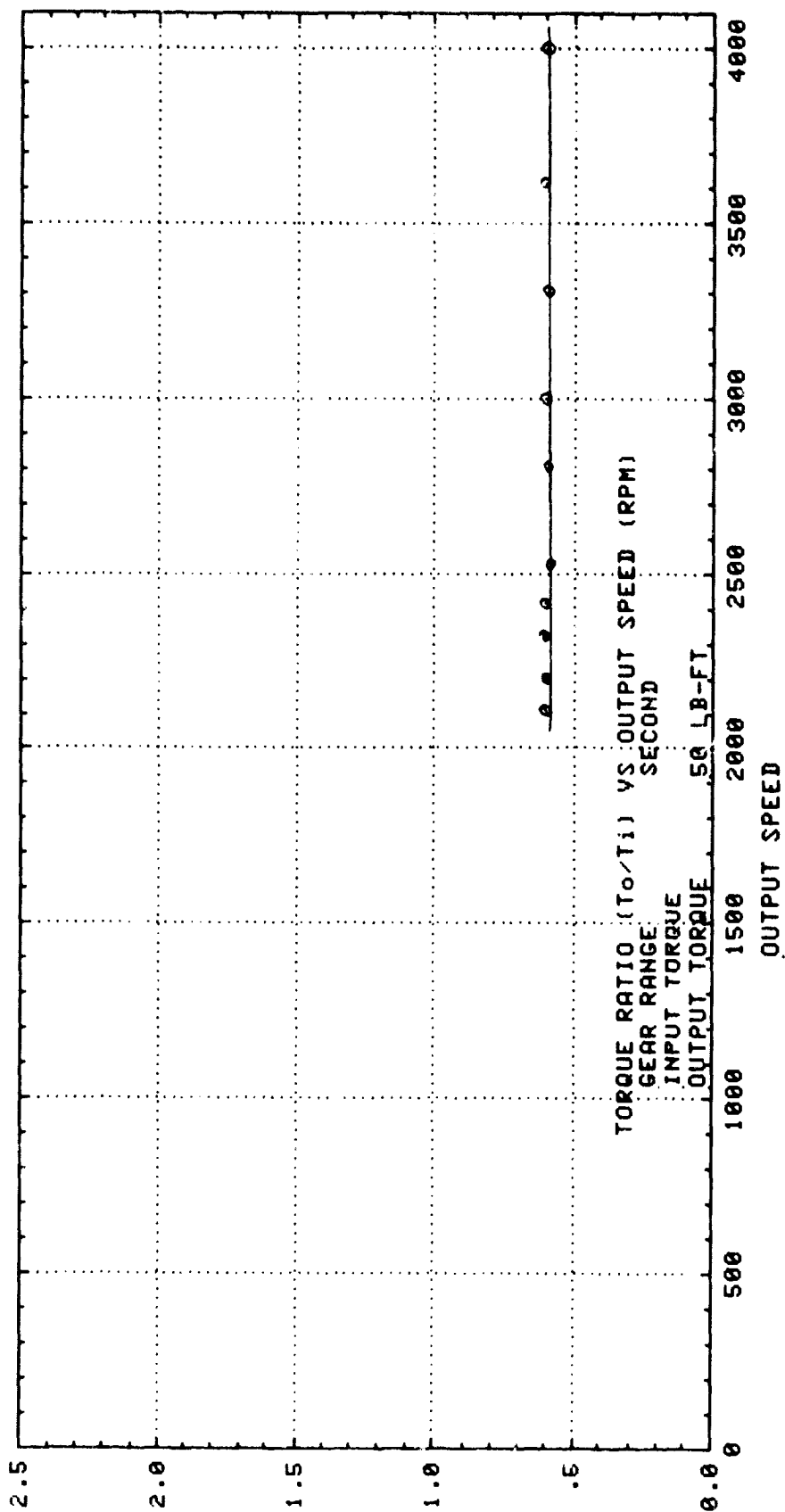

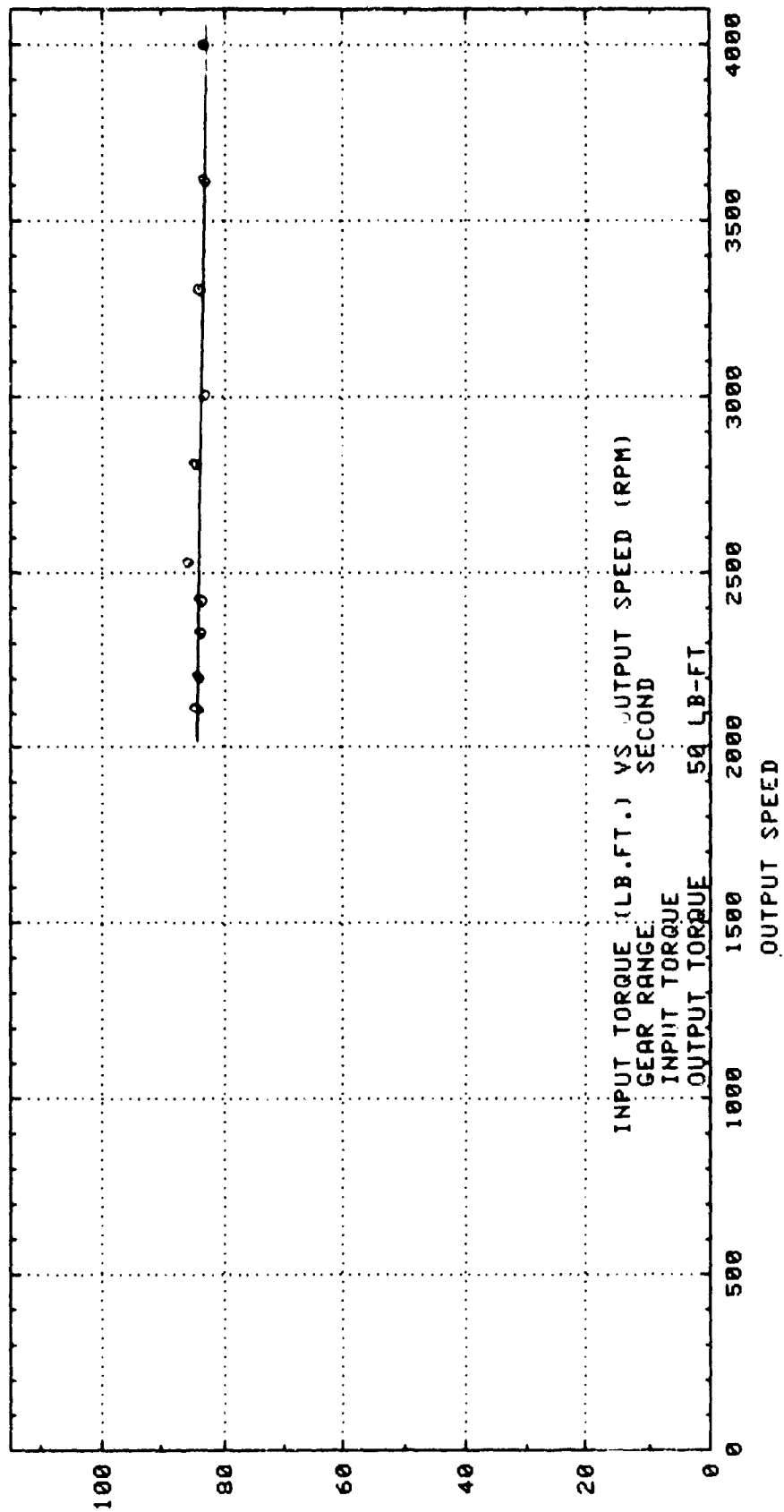

INPUT TORQUE

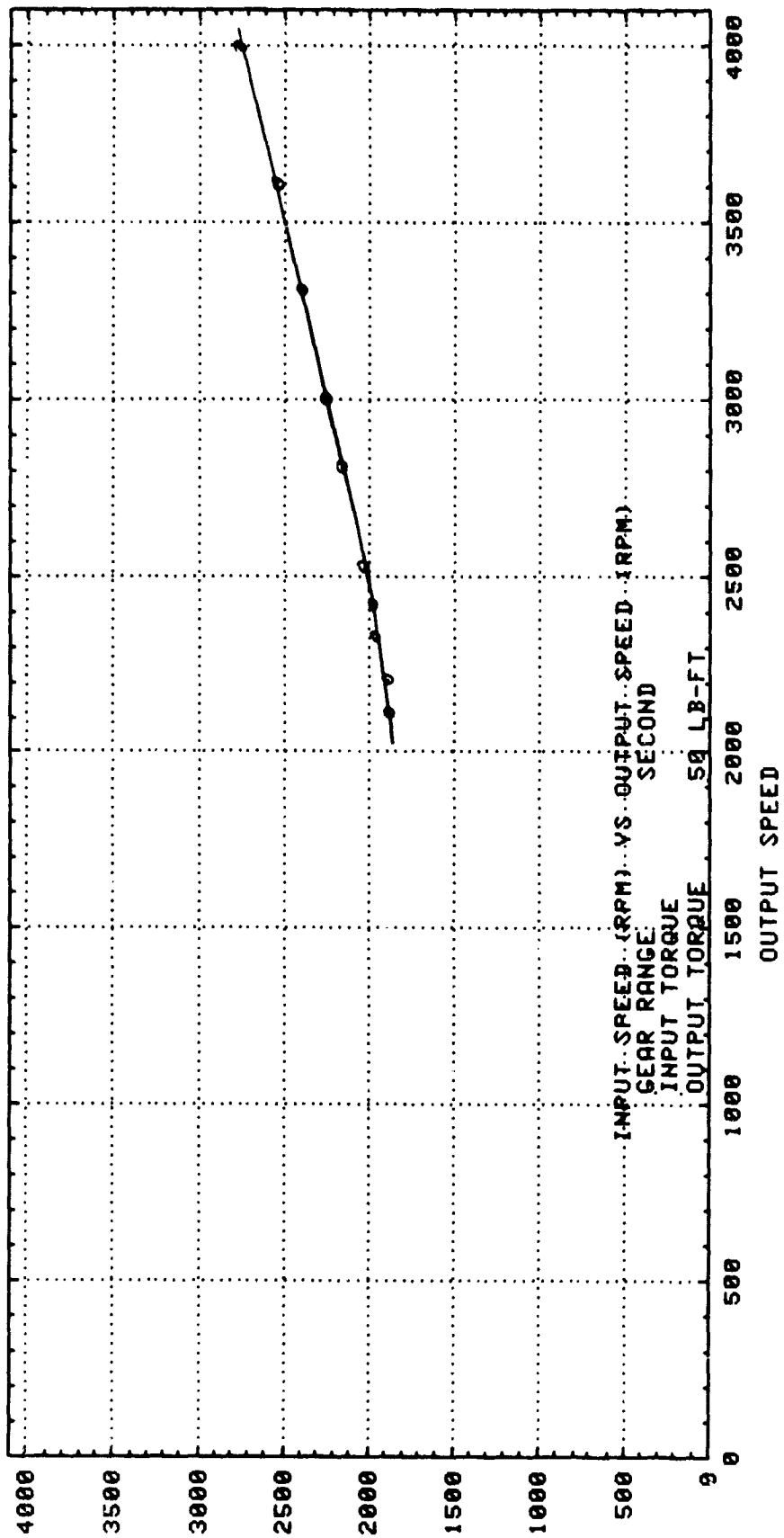

I N P U T S P E E D

EFFICIENCY

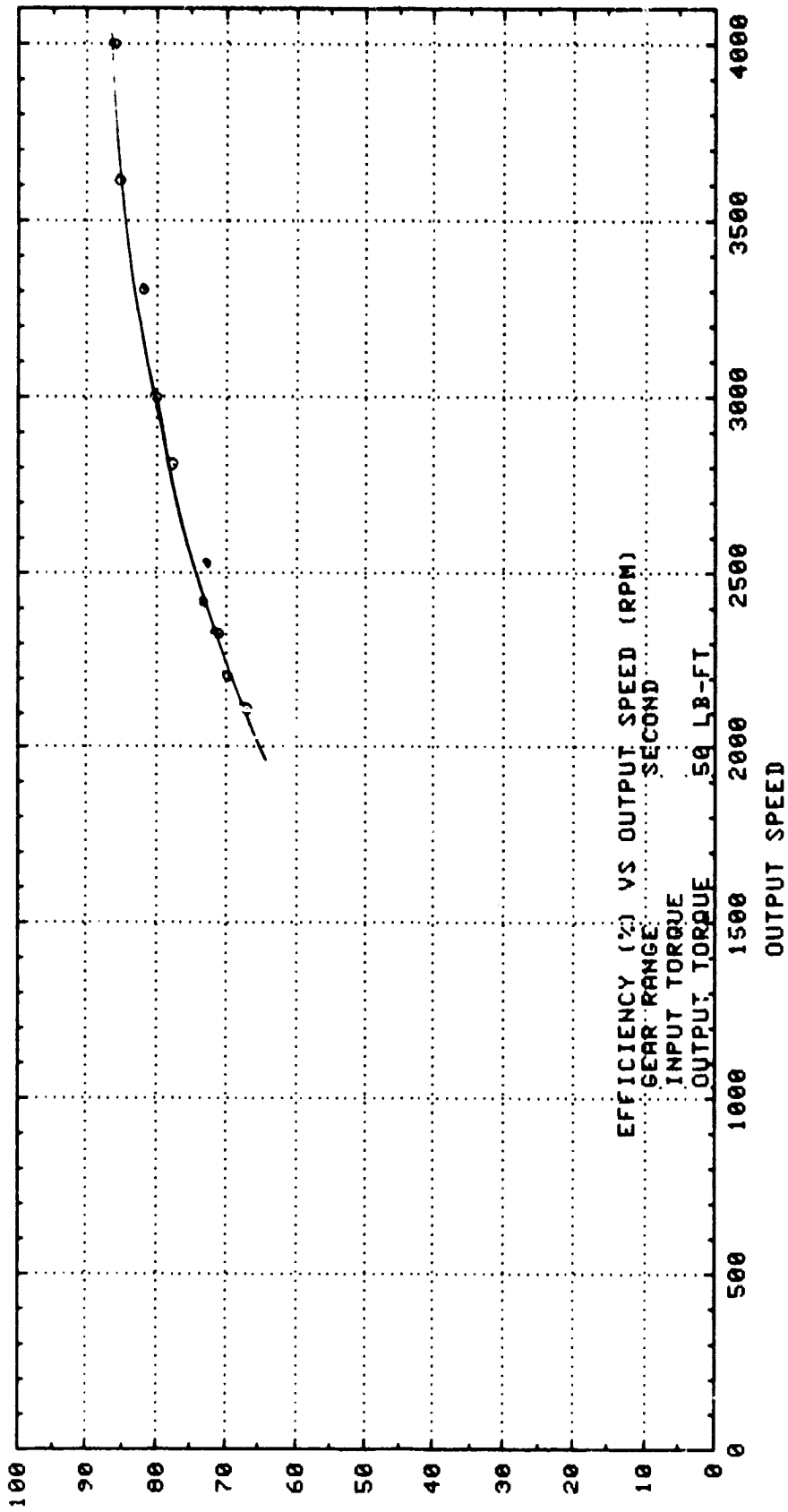

E F F I C I E N C Y

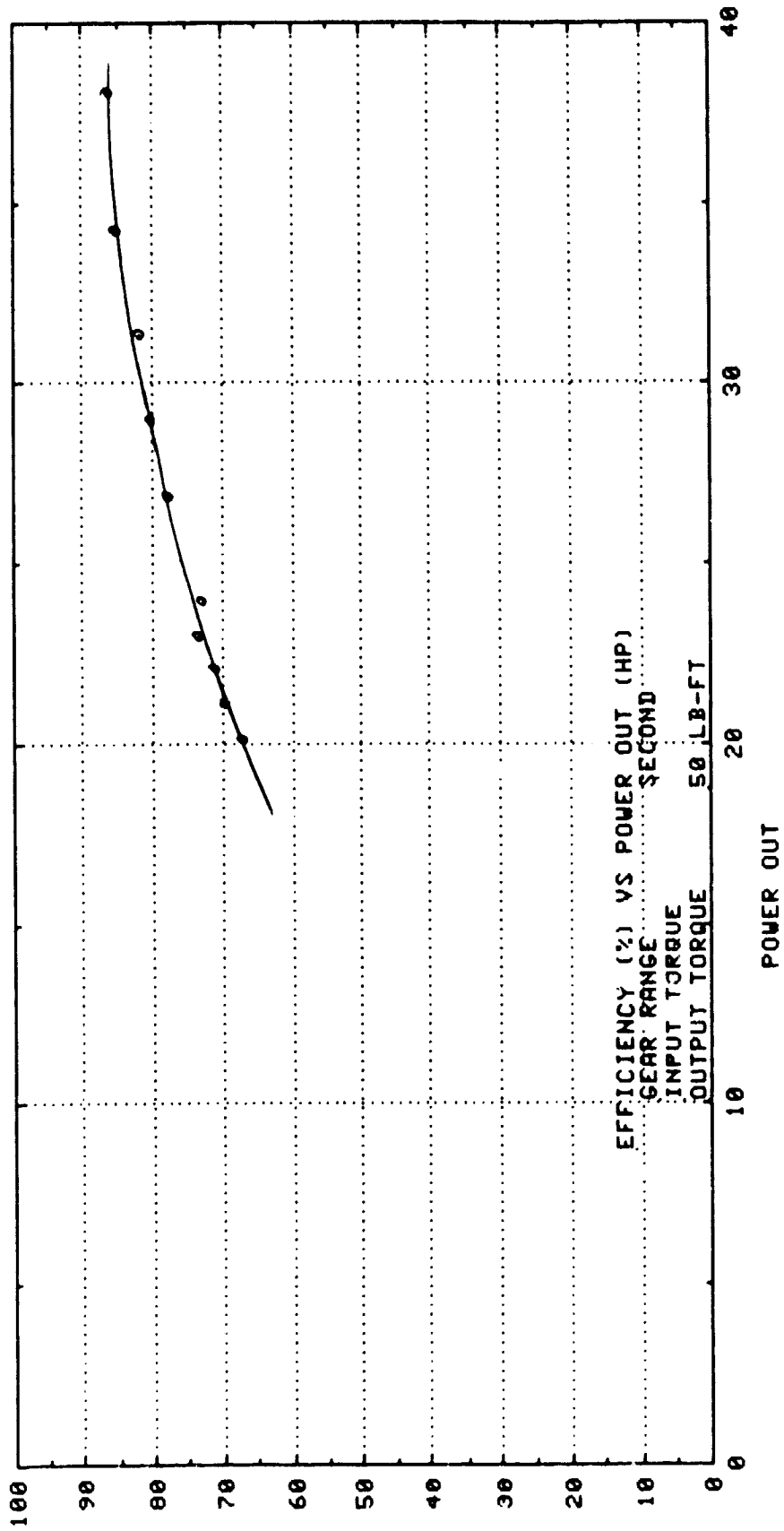

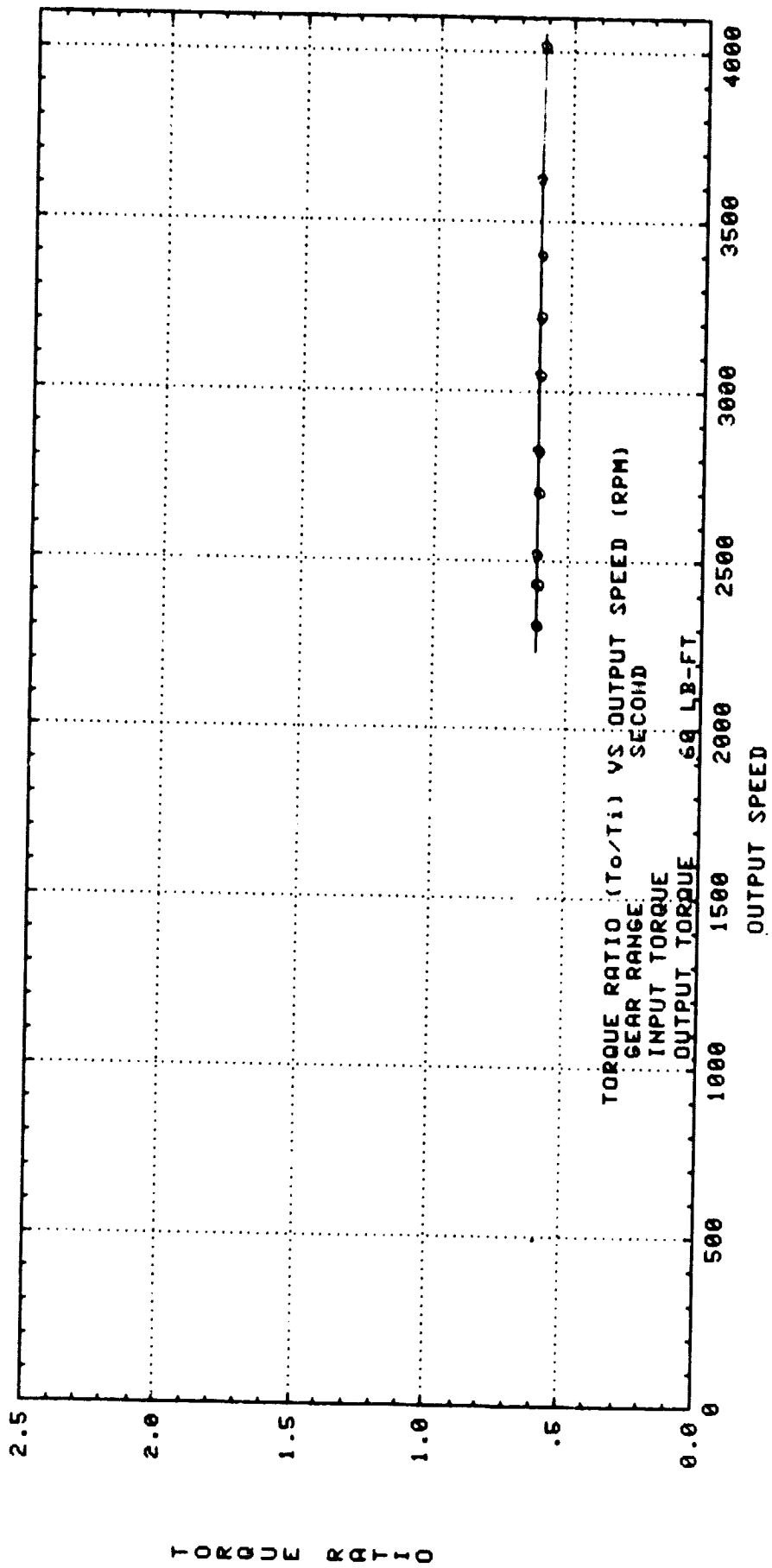

TORQUE RATIO

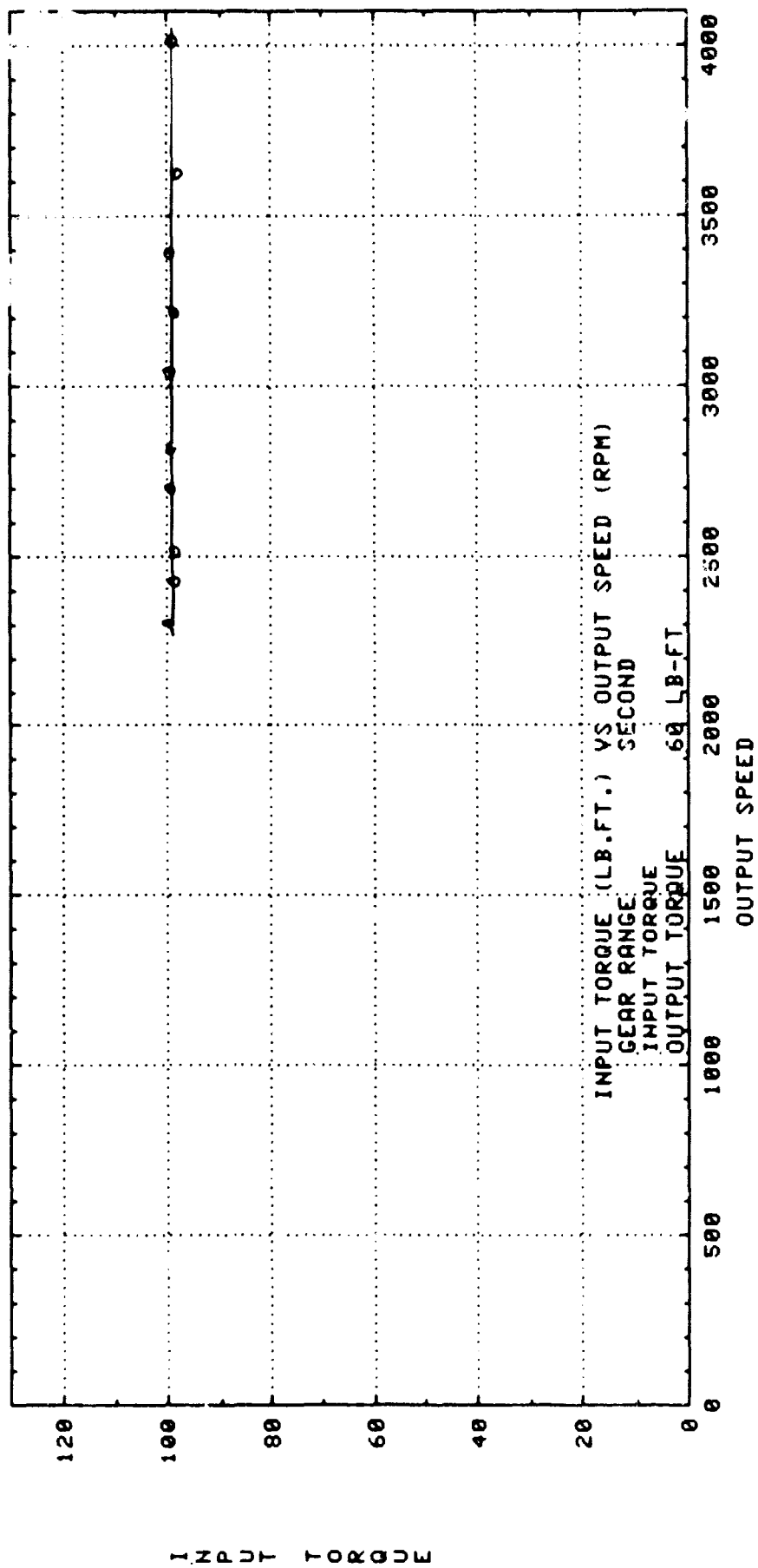

INPUT TORQUE



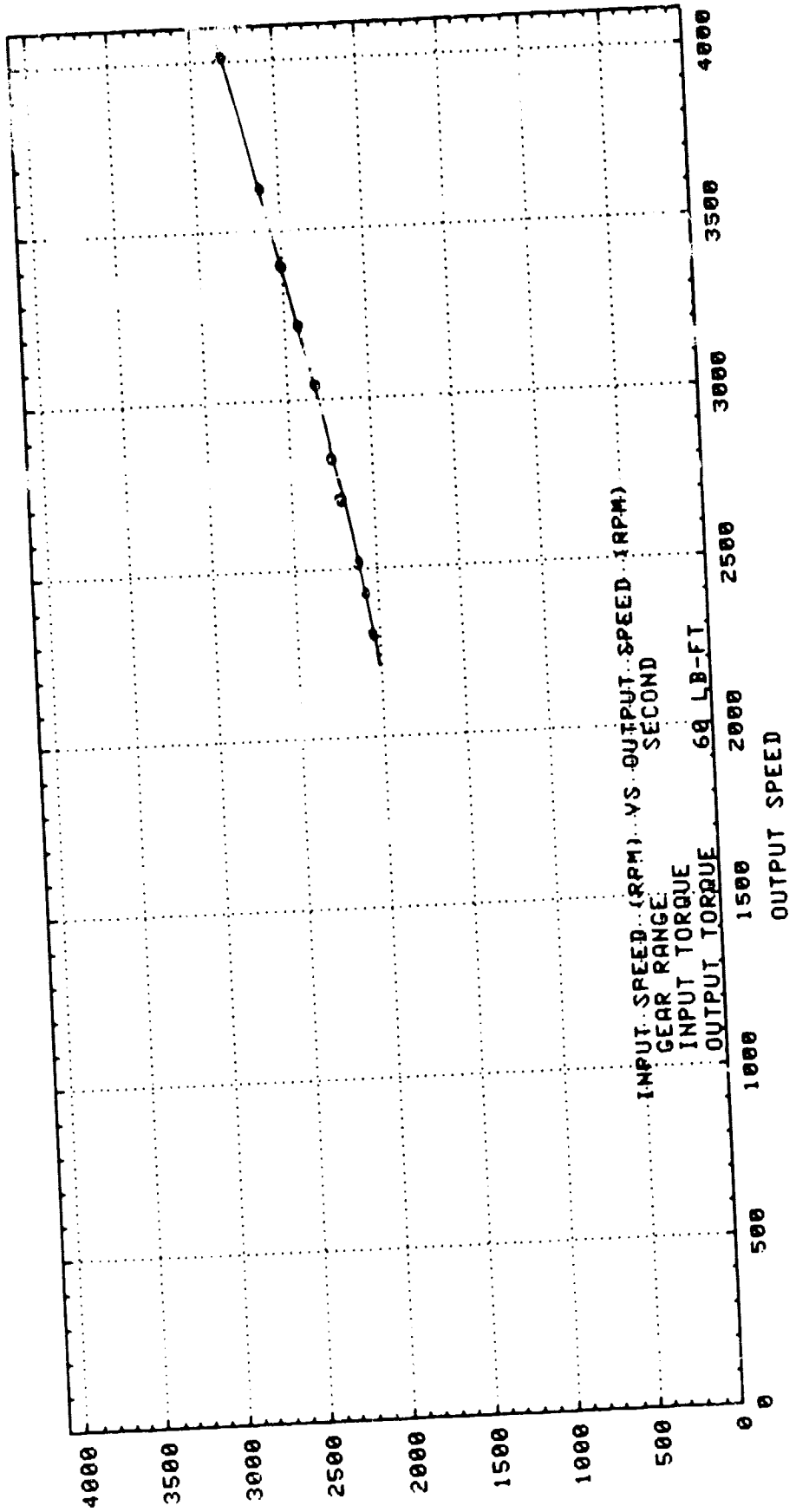

INPUT SPEED

EFFICIENCY

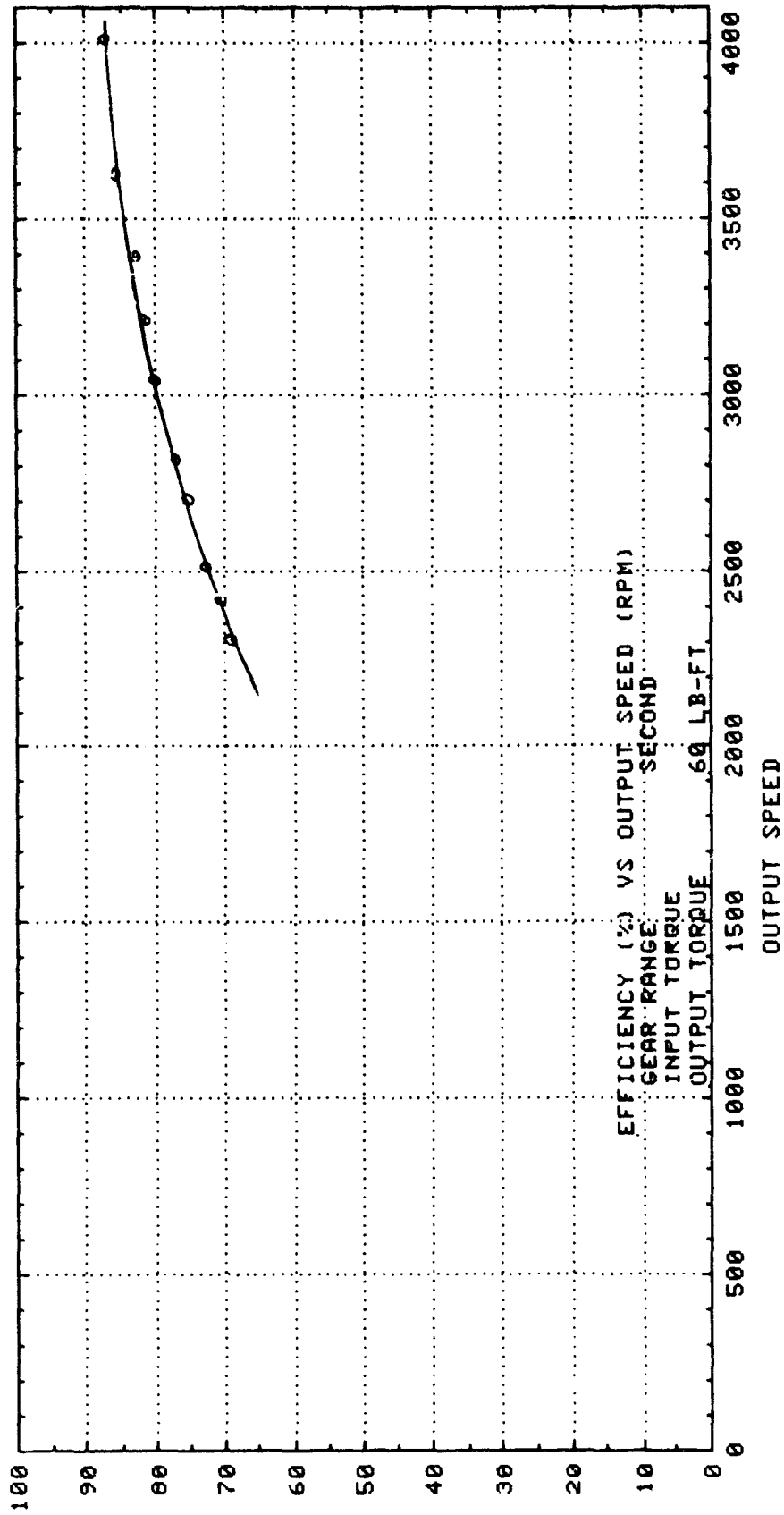

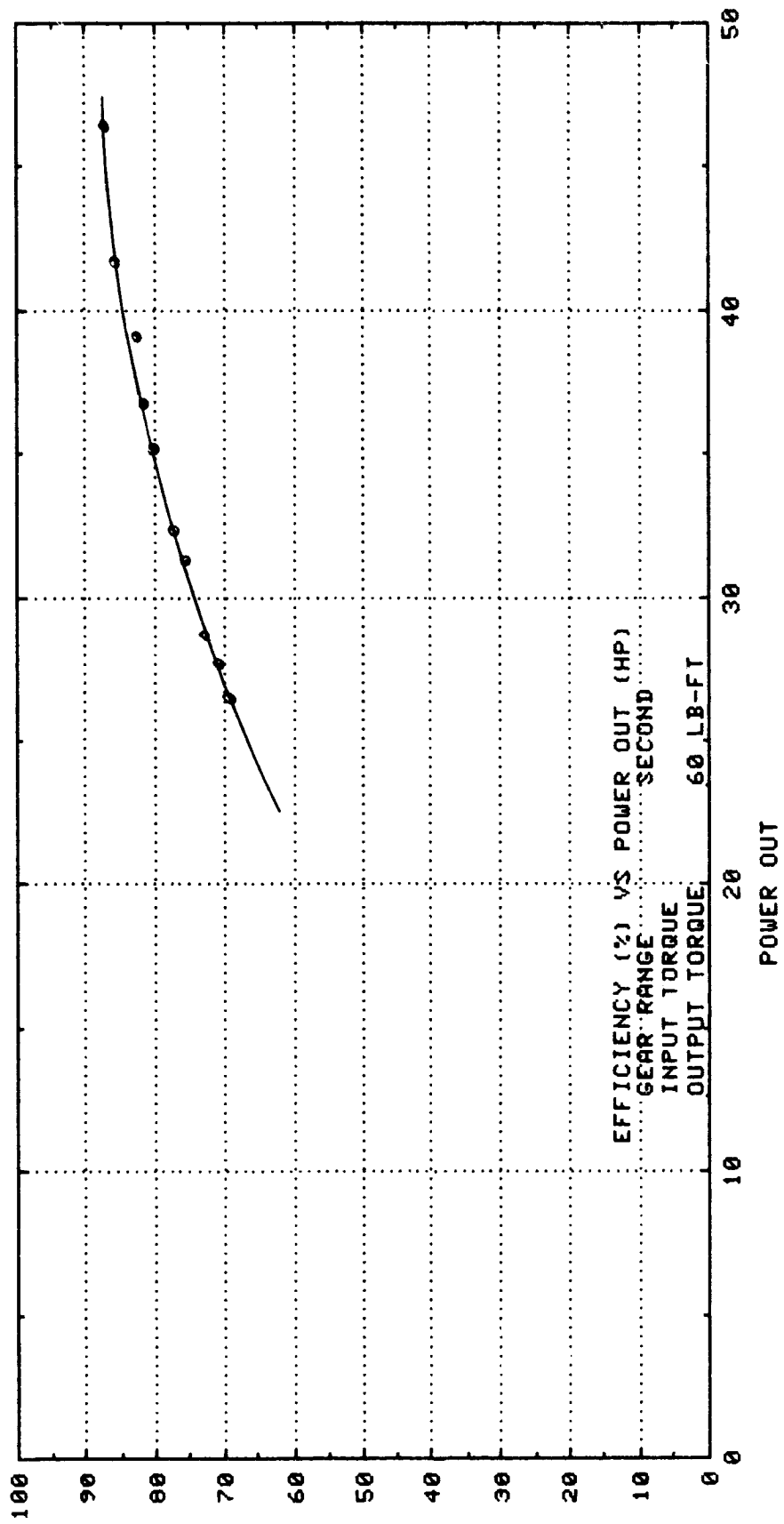

EFFICIENCY

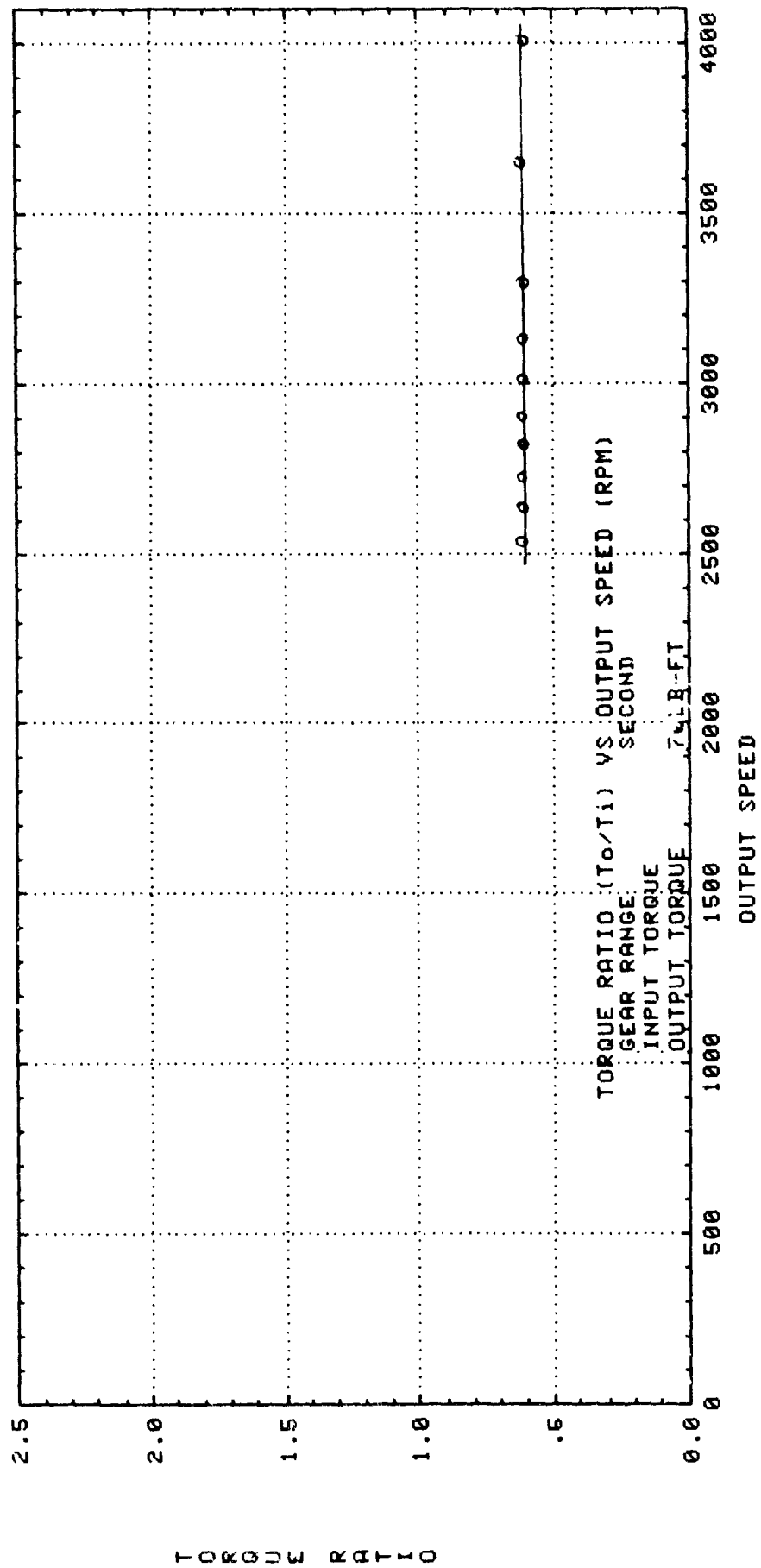

TORQUE RATIO

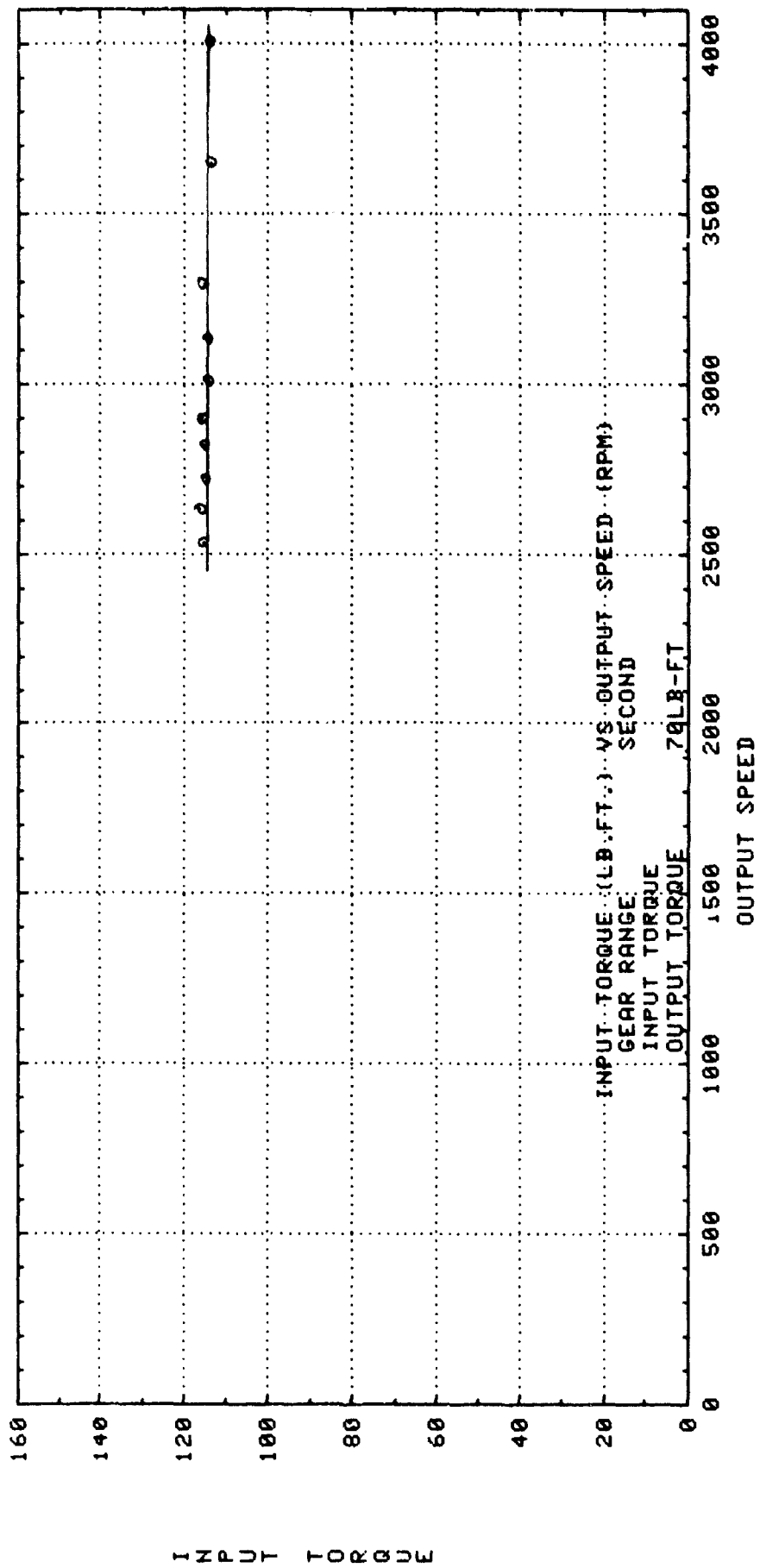

INPUT TORQUE

INPUT SPEED

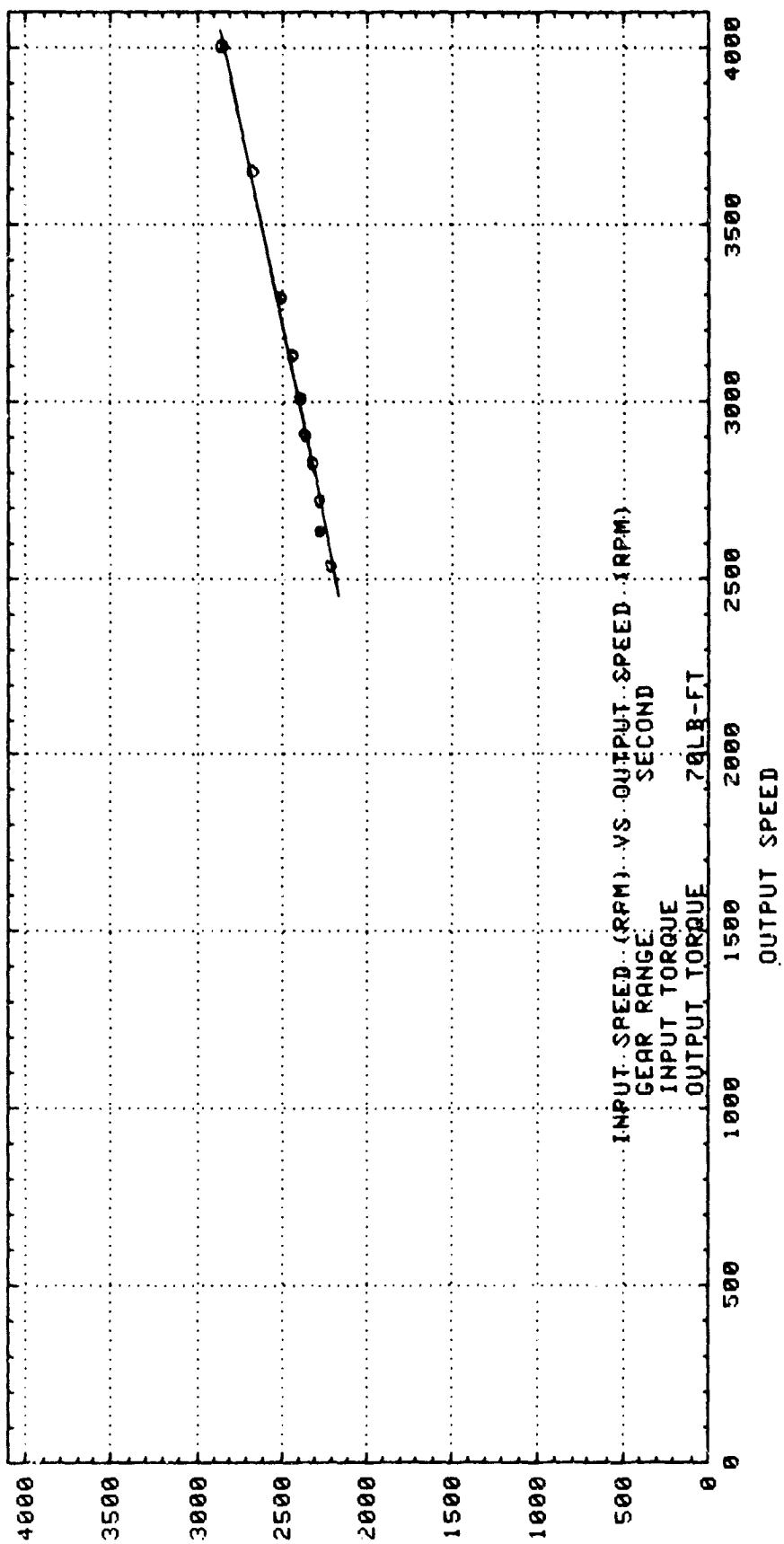

EFFICIENCY

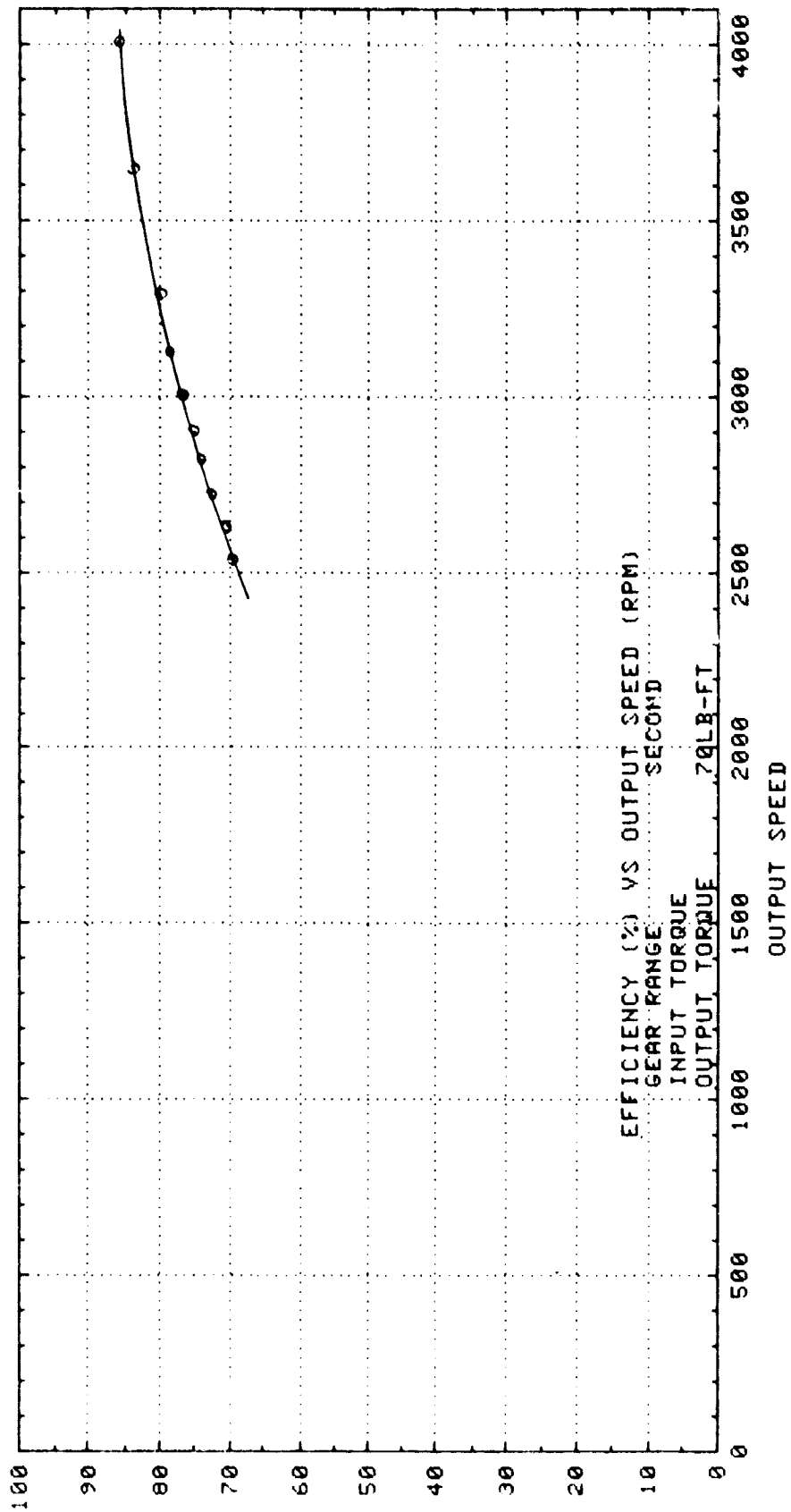

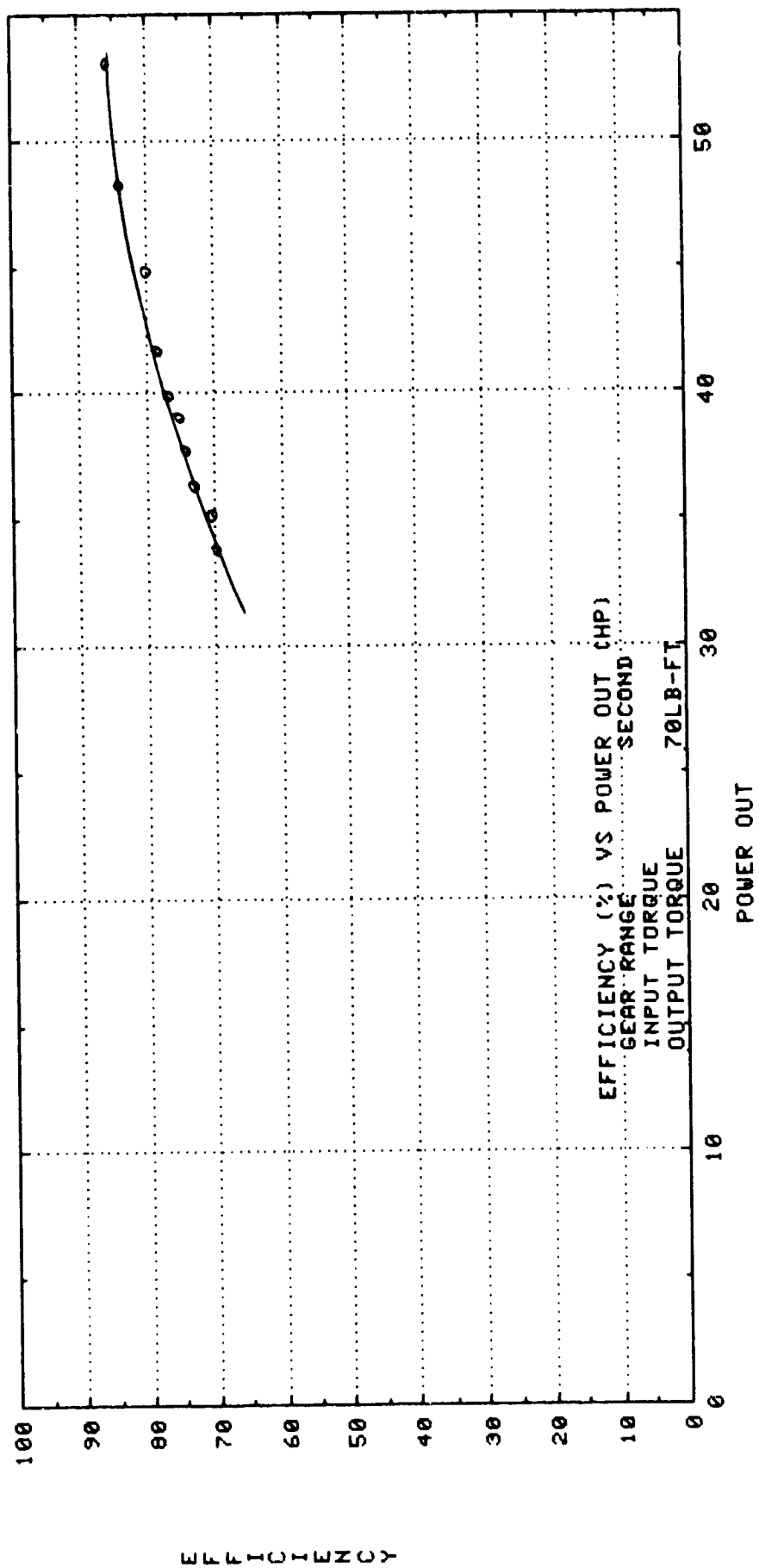

EFFICIENCY



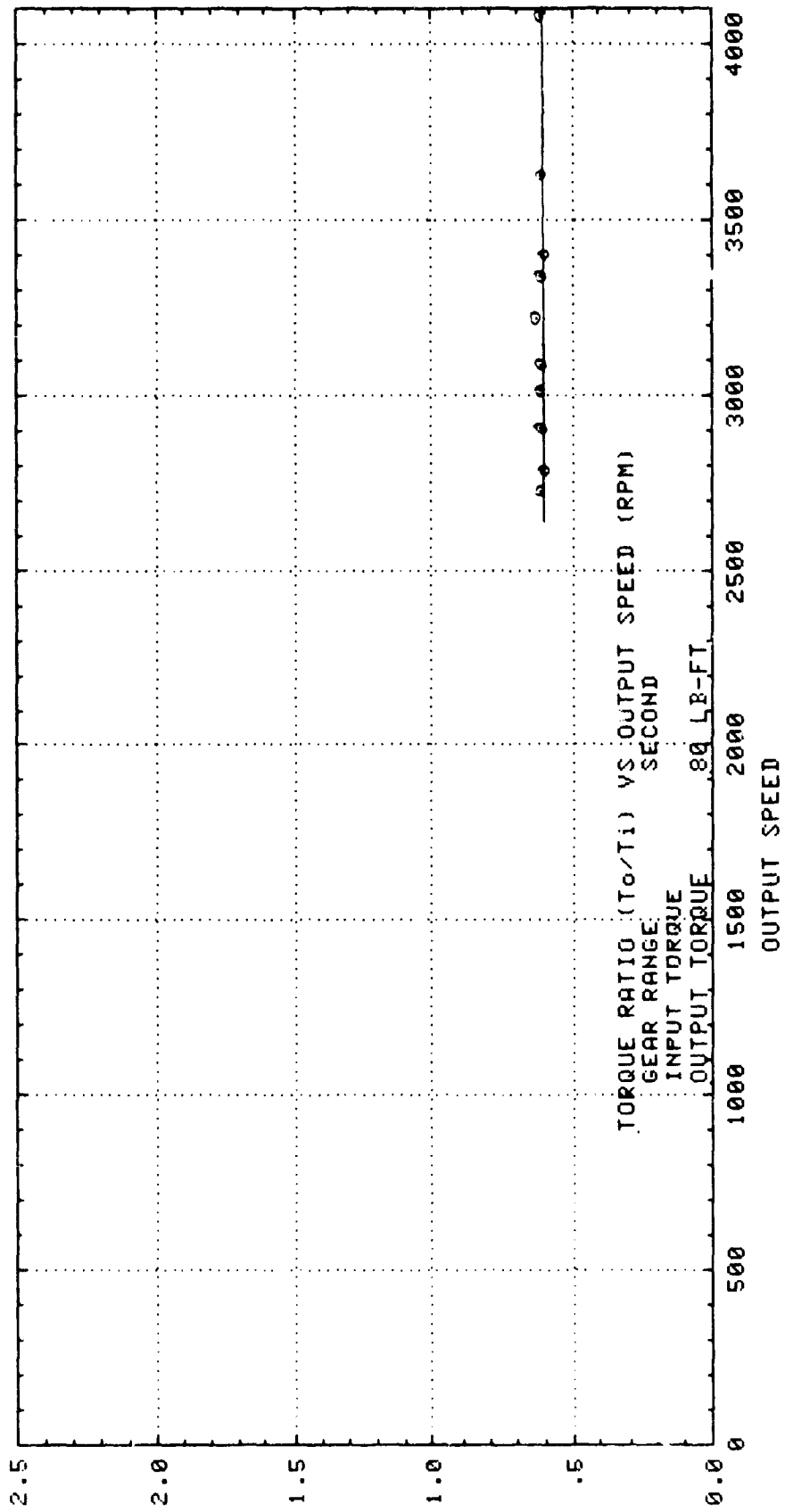

TORQUE RATIO

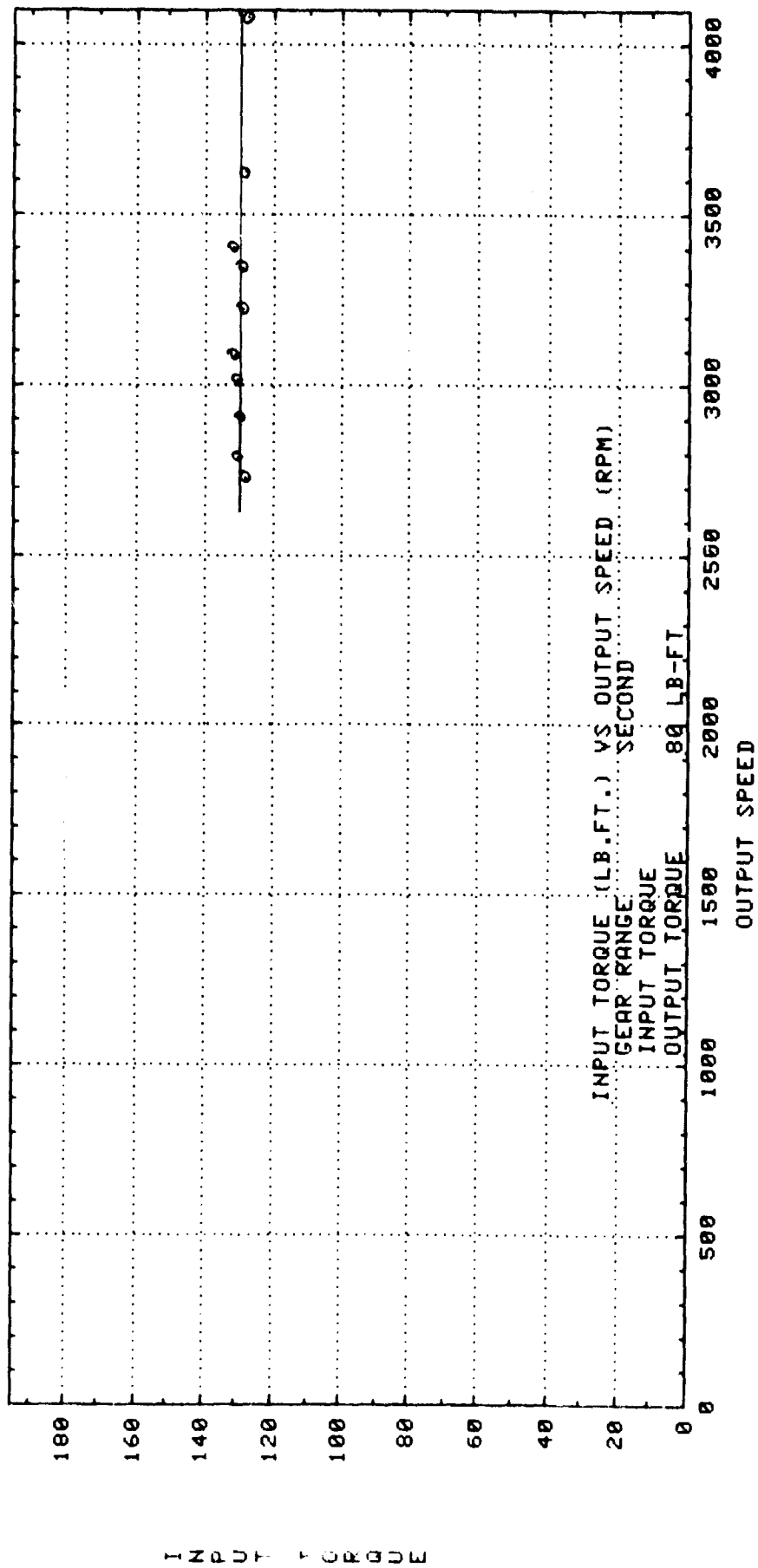

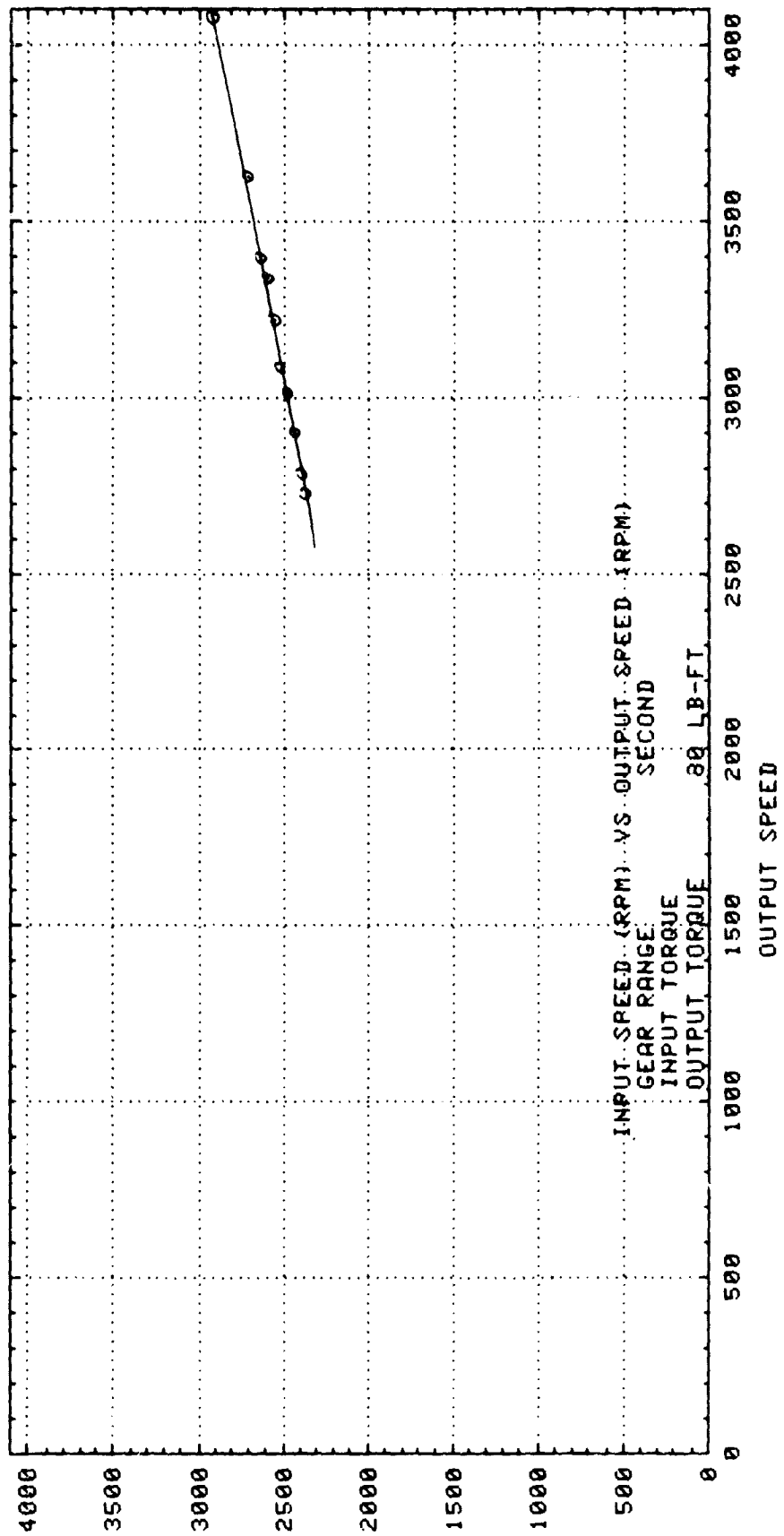

INPUT SPEED

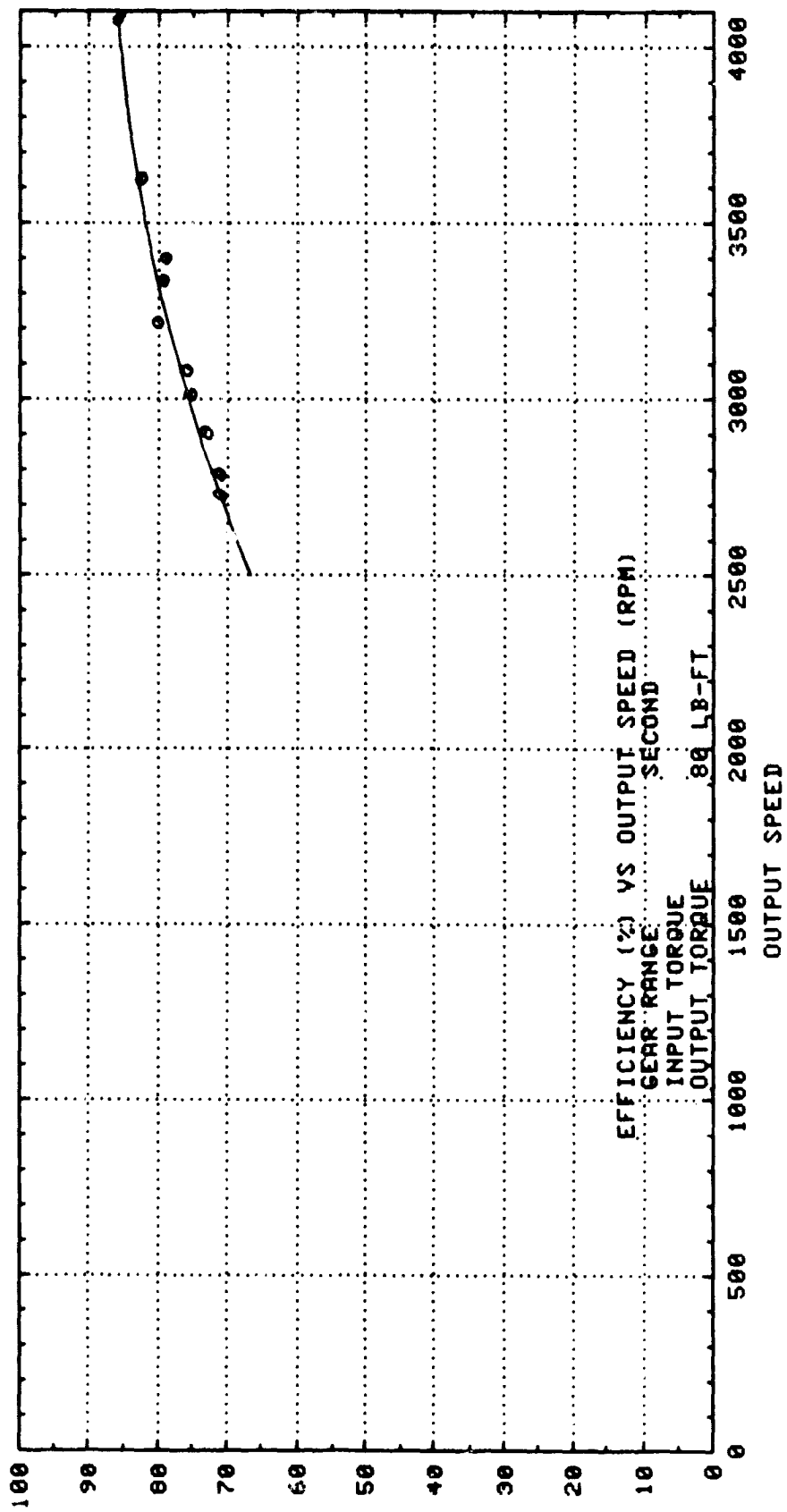

EFFICIENCY

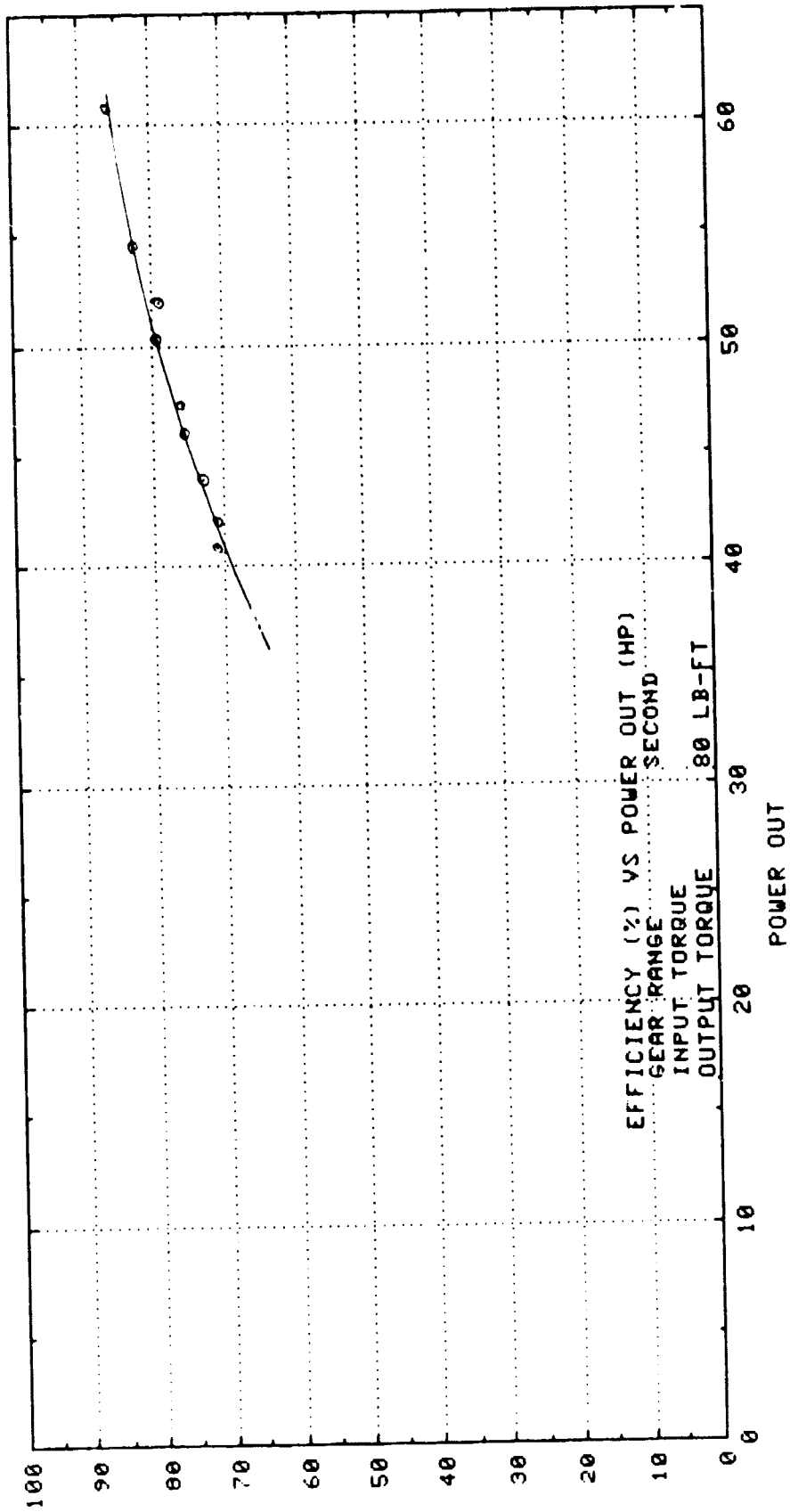

EFFICIENCY

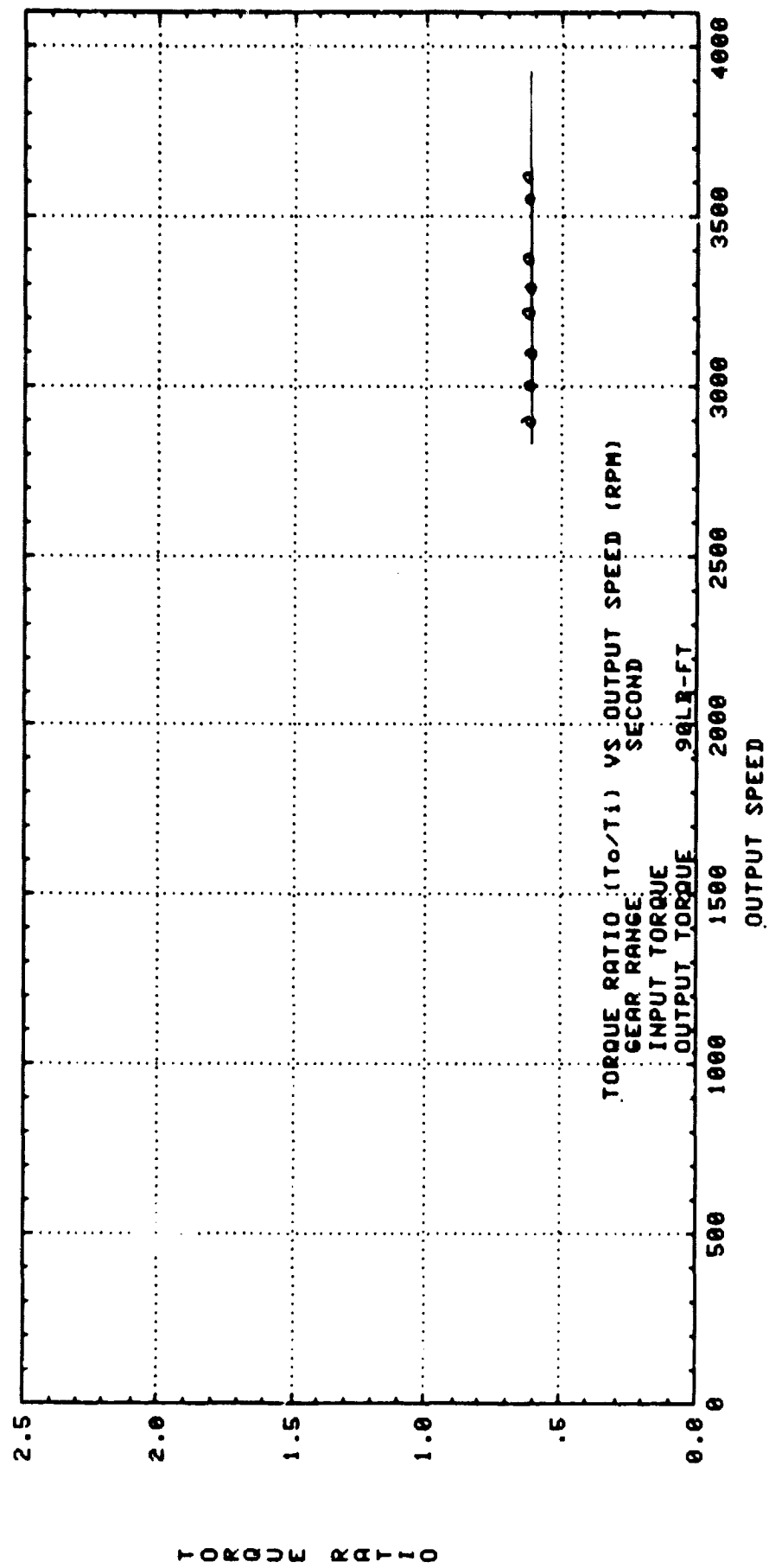

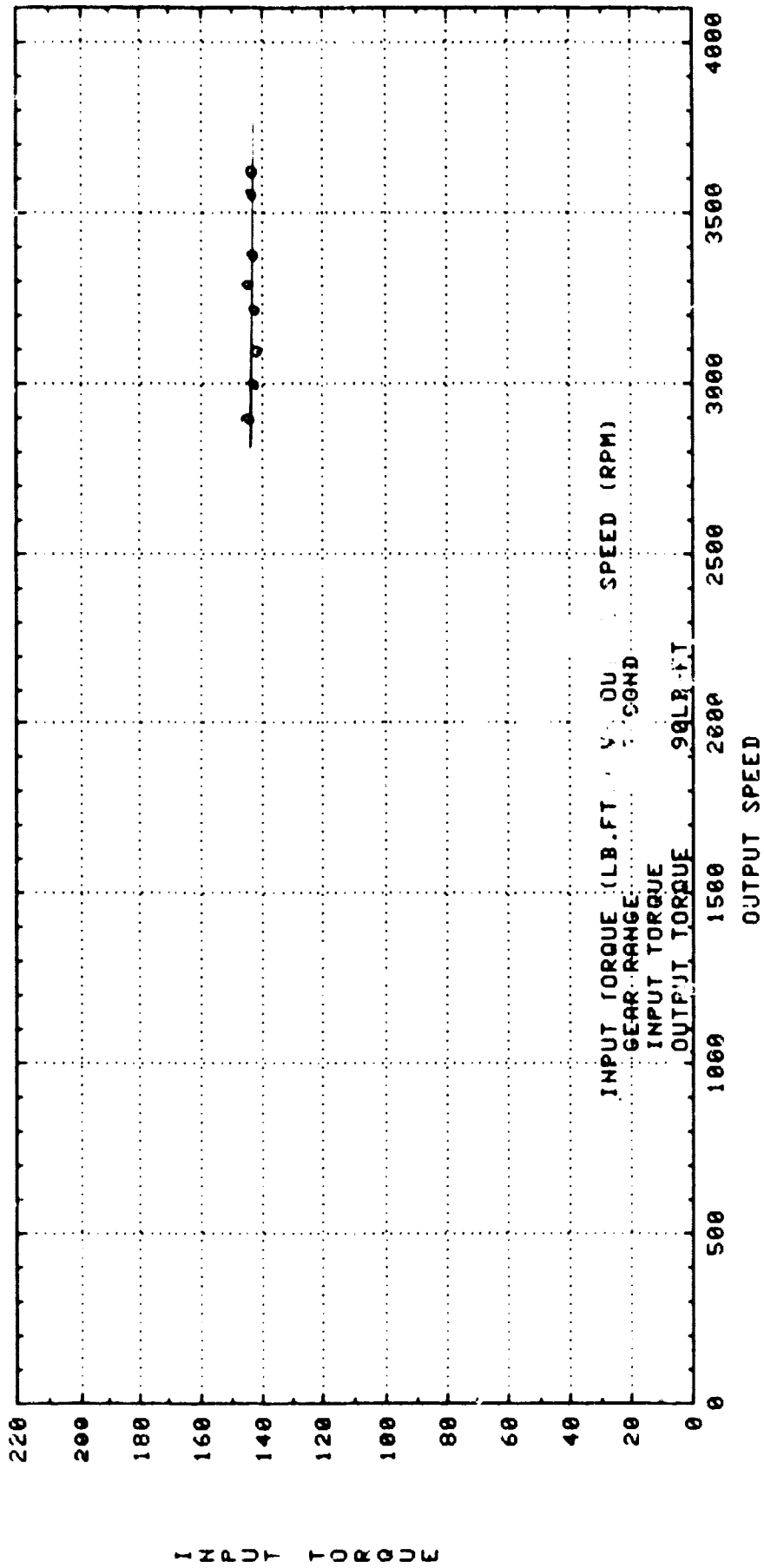

I N P U T T O R Q U E

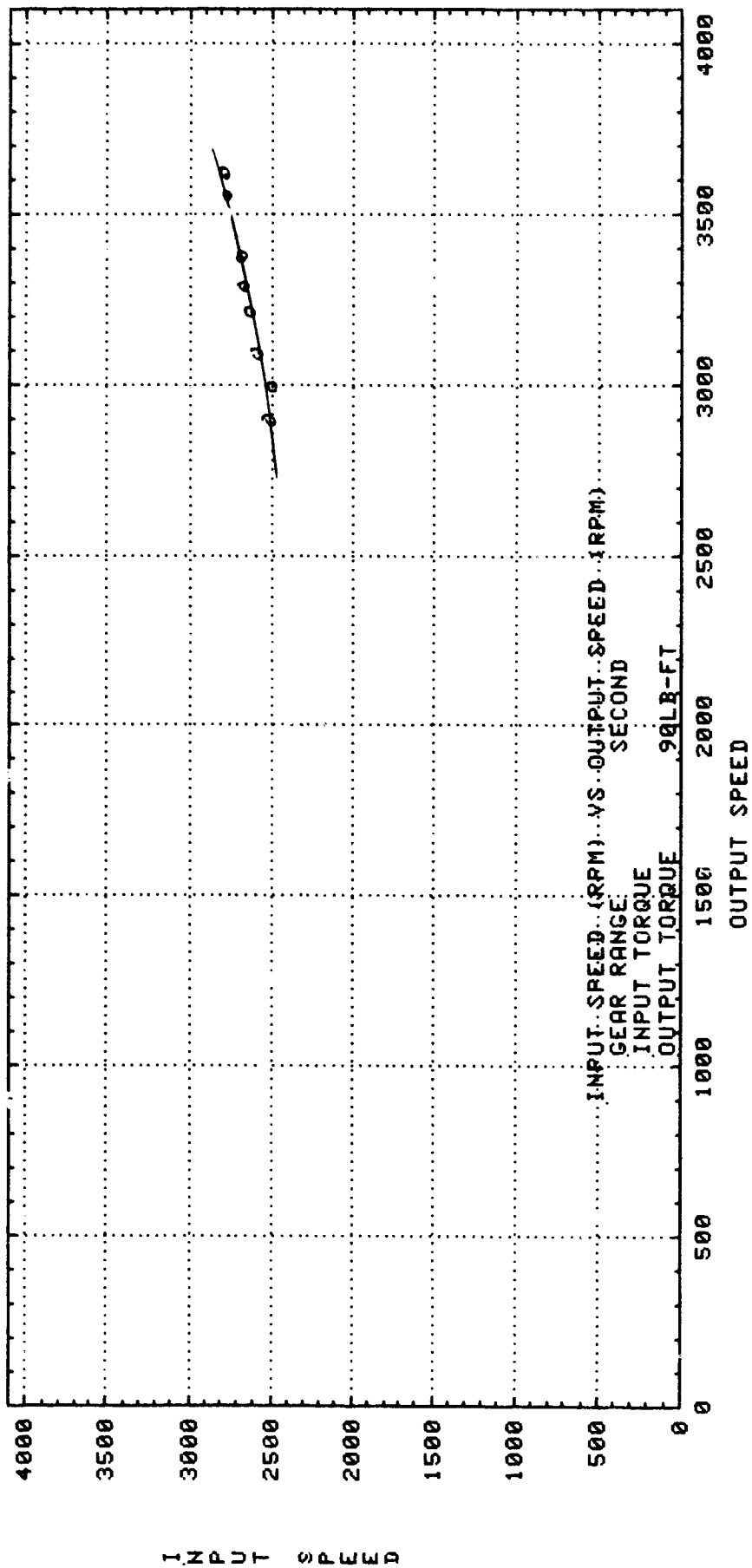



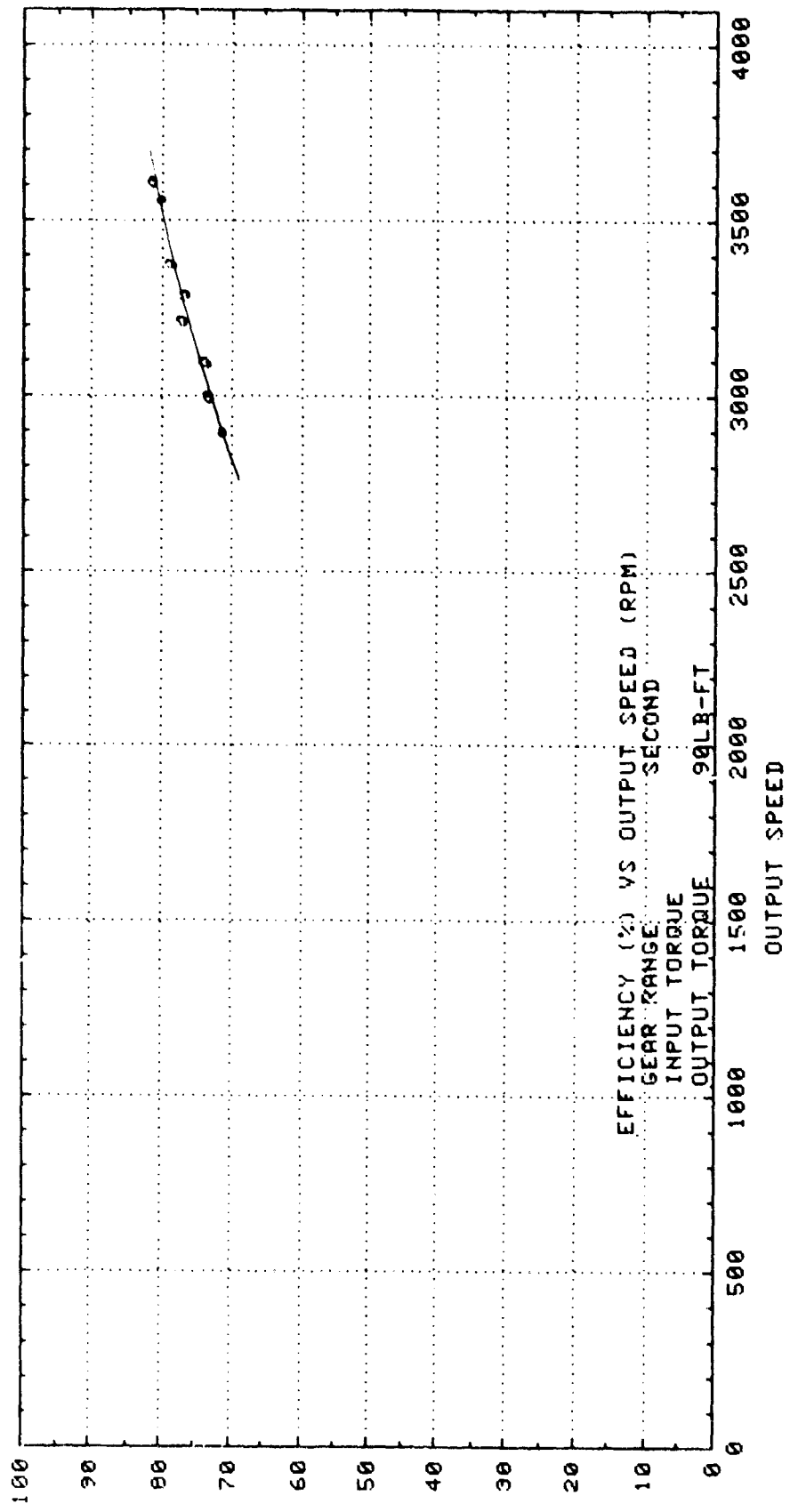

EFFICIENCY

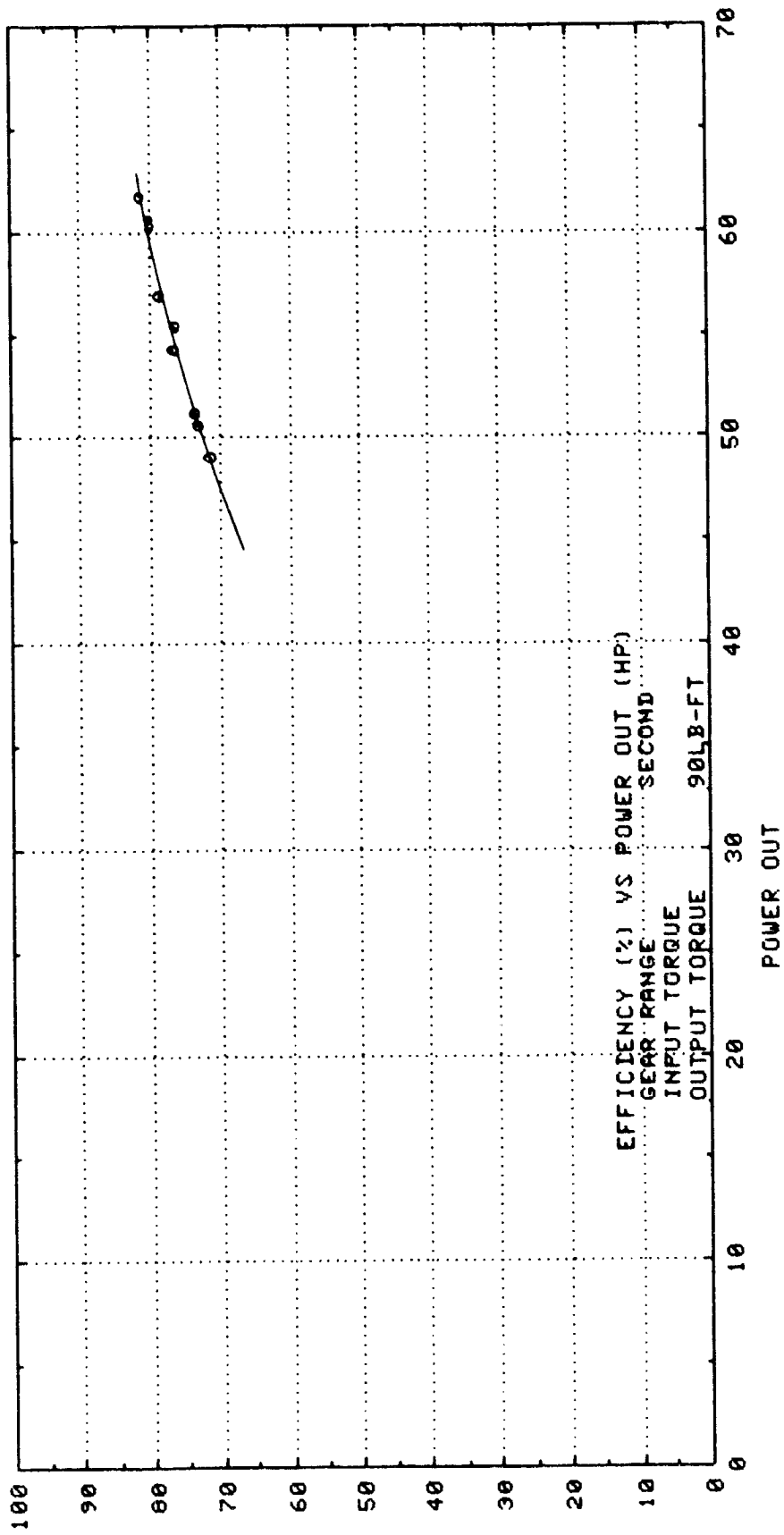

EFFICIENCY

**COAST PERFORMANCE**

**3rd Gear**

## Graphs Contained in This Section

Torque Ratio -vs- Output Speed

Output Torque -vs- Output Speed

Input Speed -vs- Output Speed

Efficiency -vs- Output Speed

Efficiency -vs- Power Out

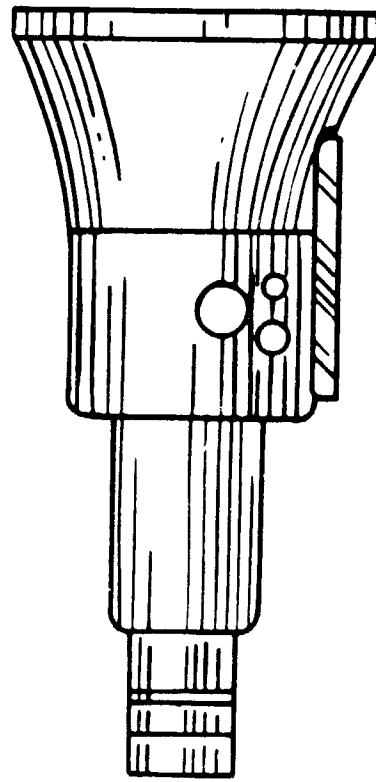

Torque In

Speed In

Torque Out

Speed Out

---

**Coast Performance Tests**

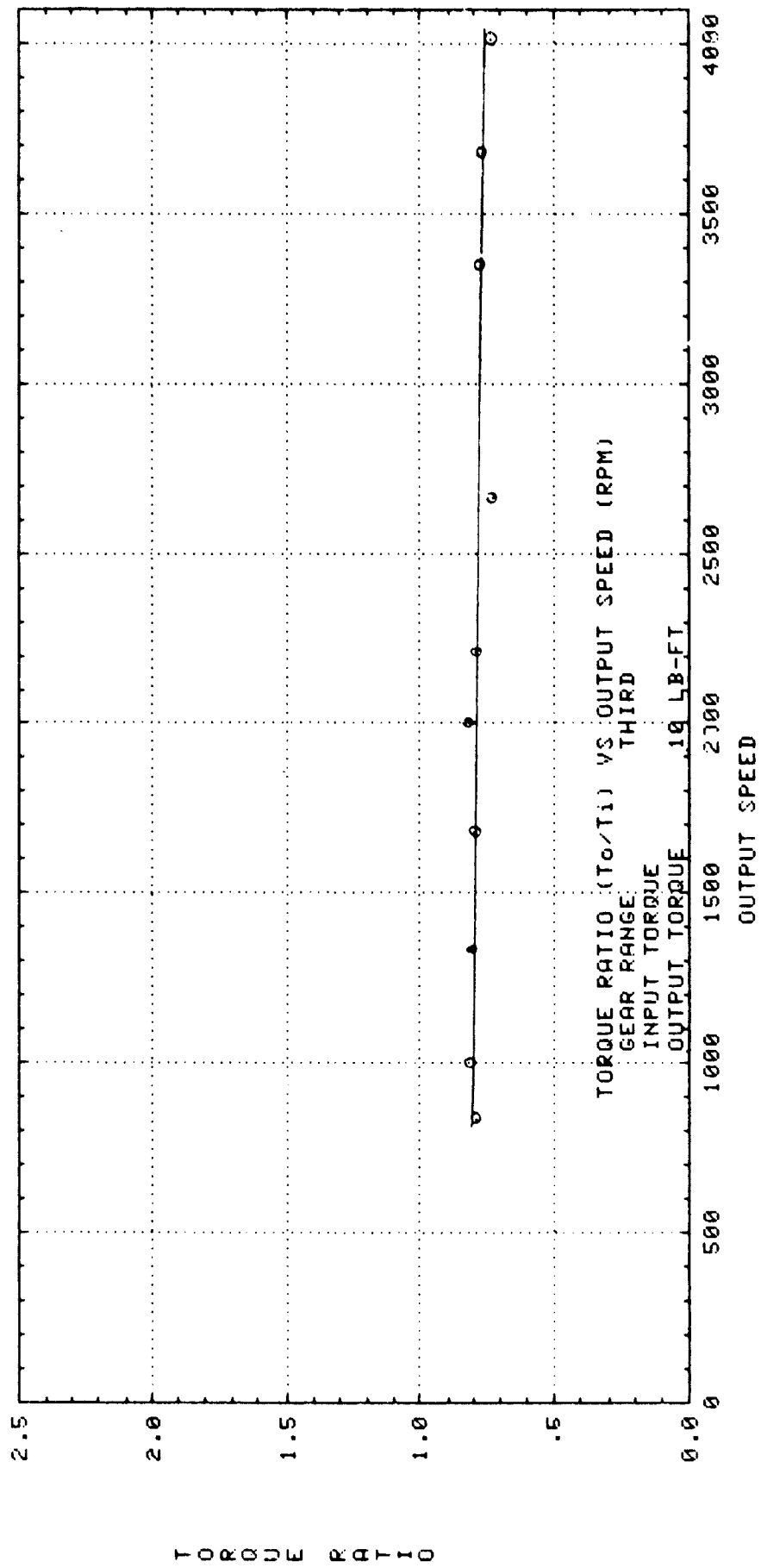

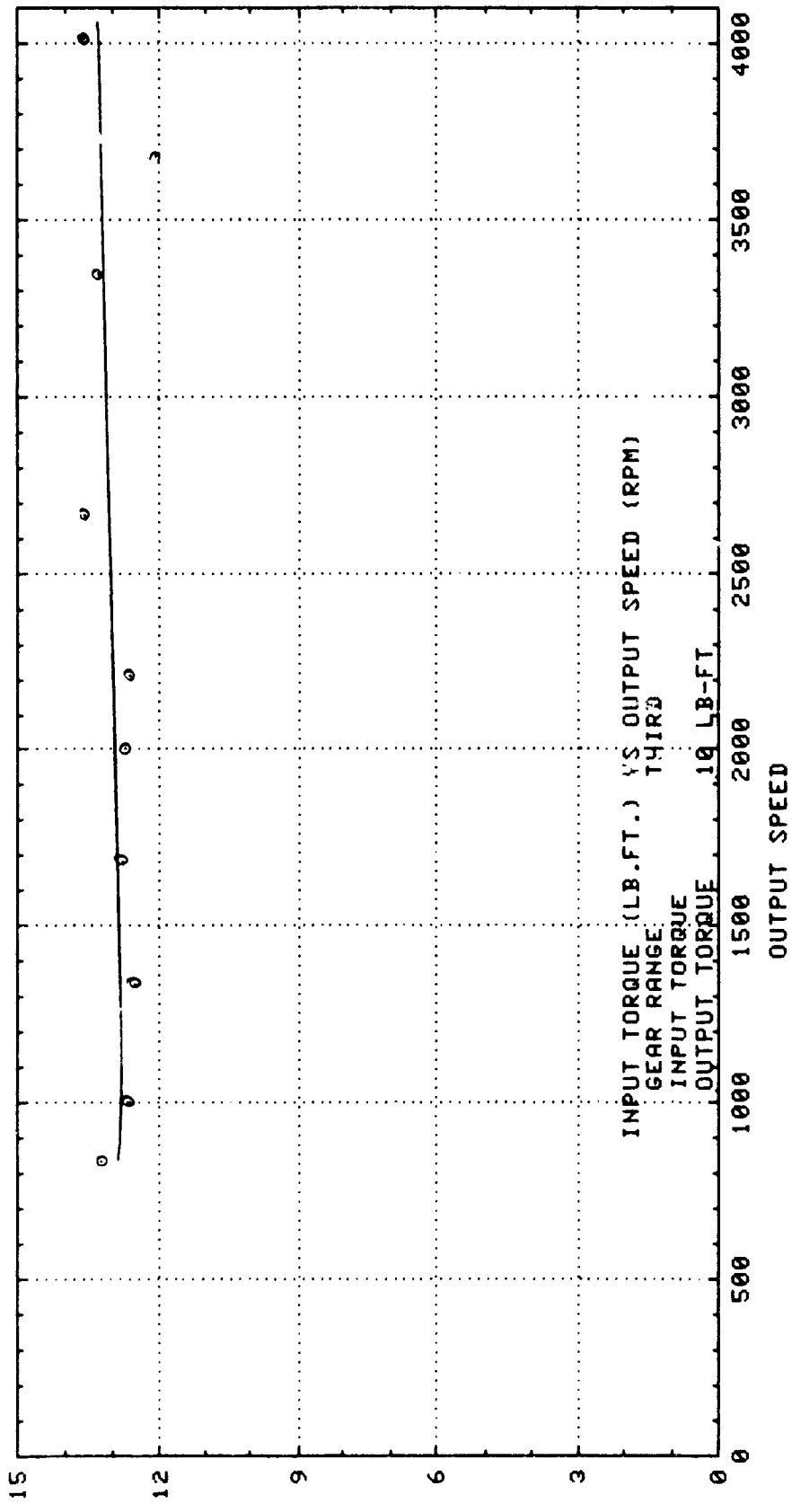

INPUT TORQUE

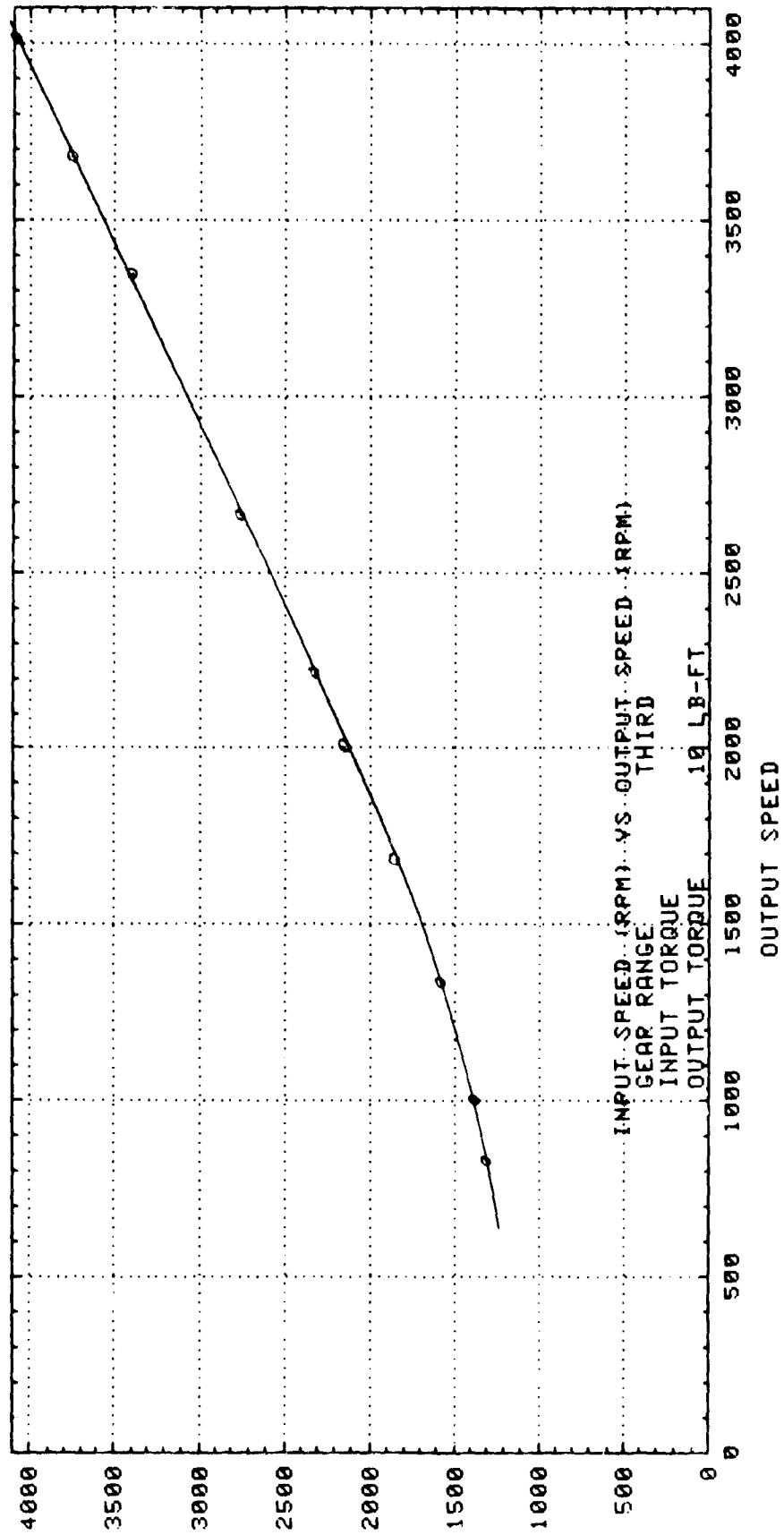

INPUT SPEED

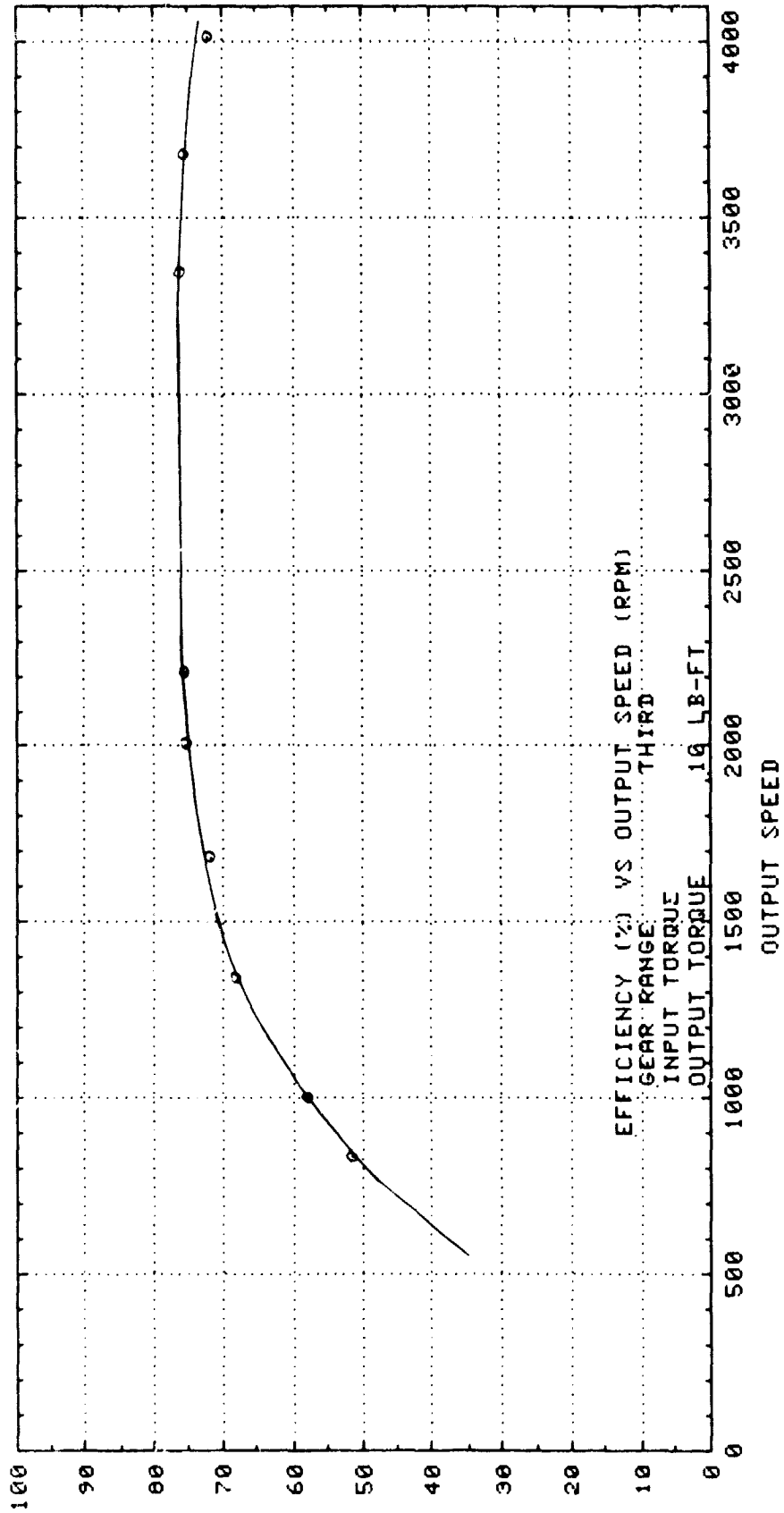

EFFICIENCY



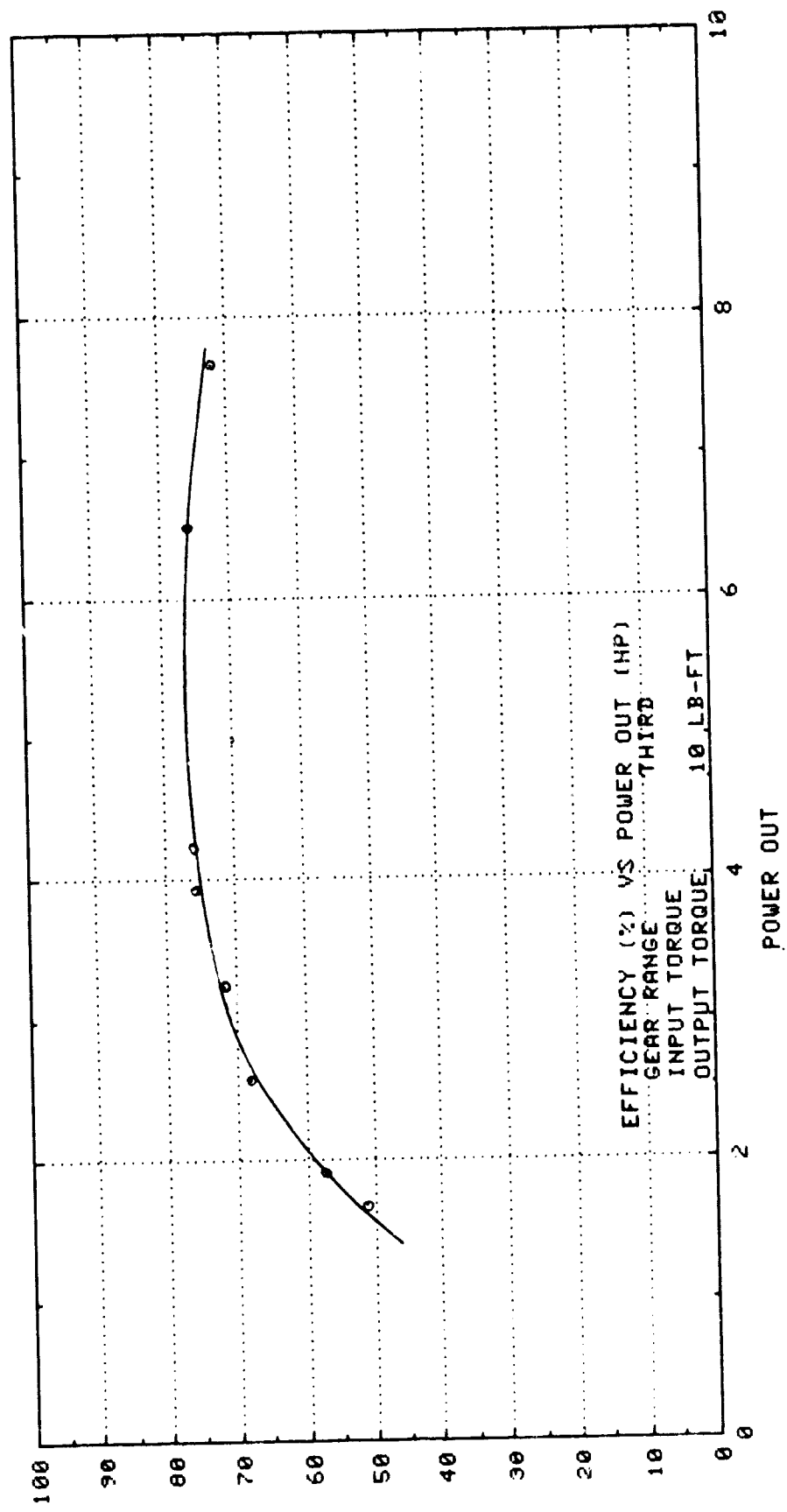

EFFICIENCY

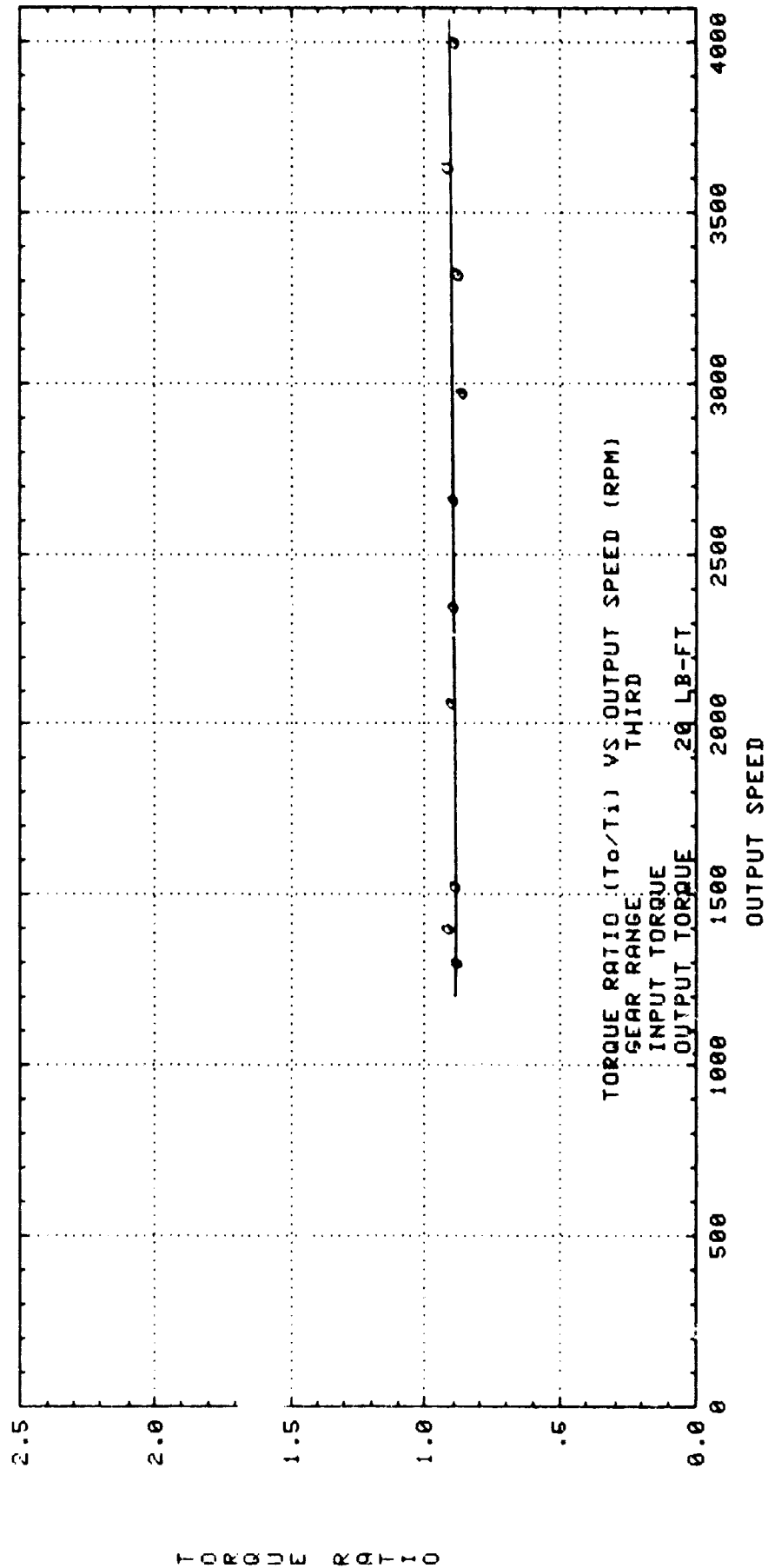

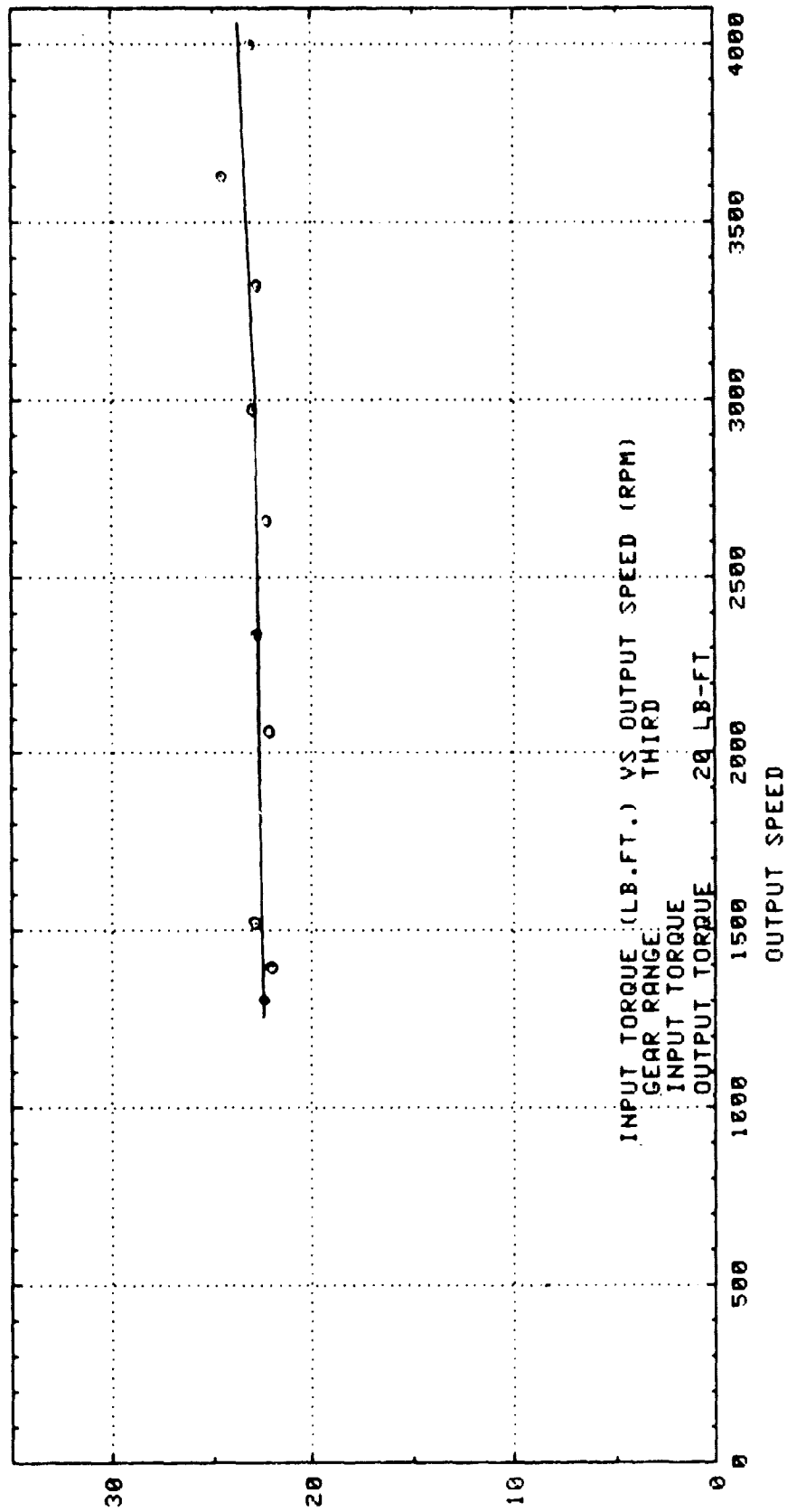

INPUT TORQUE

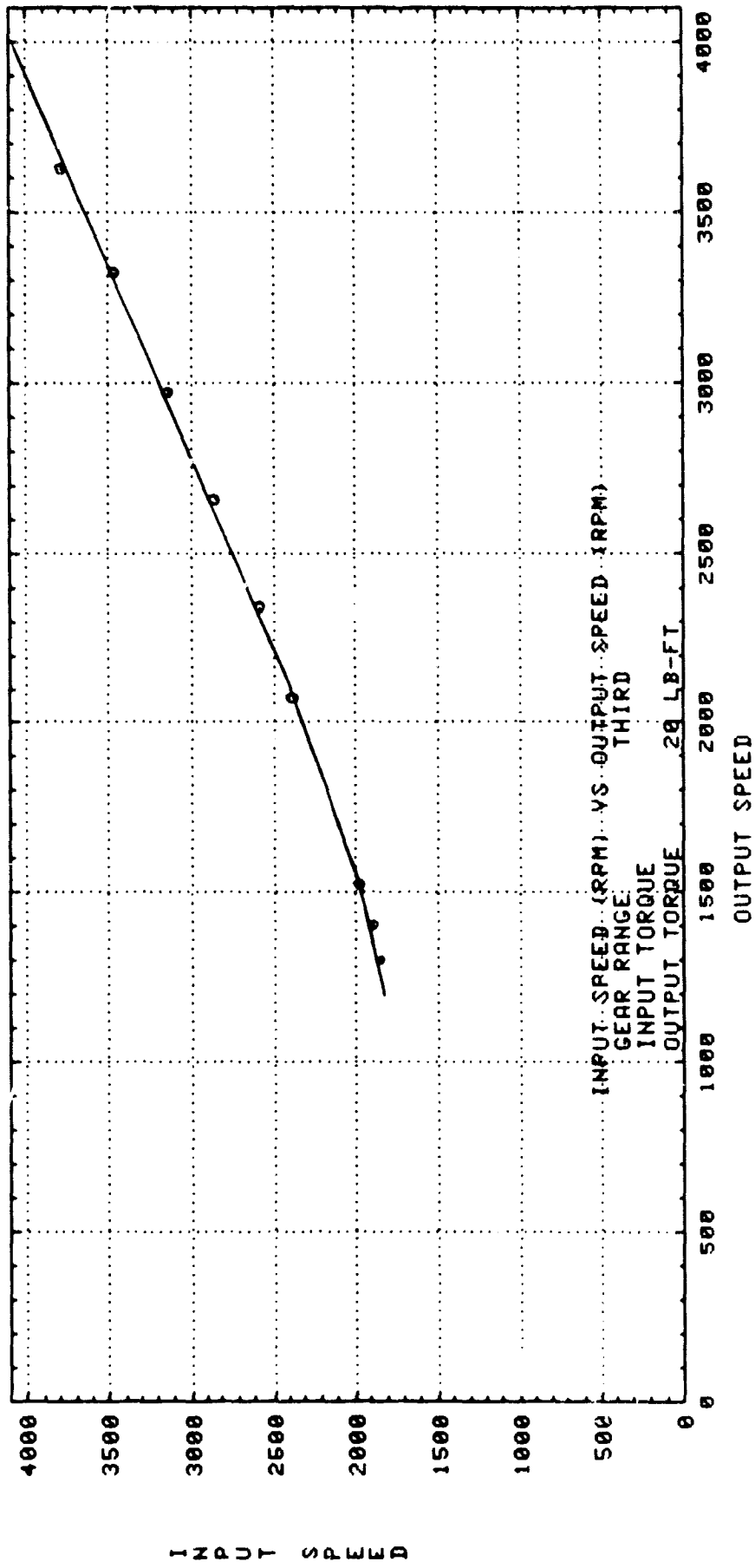

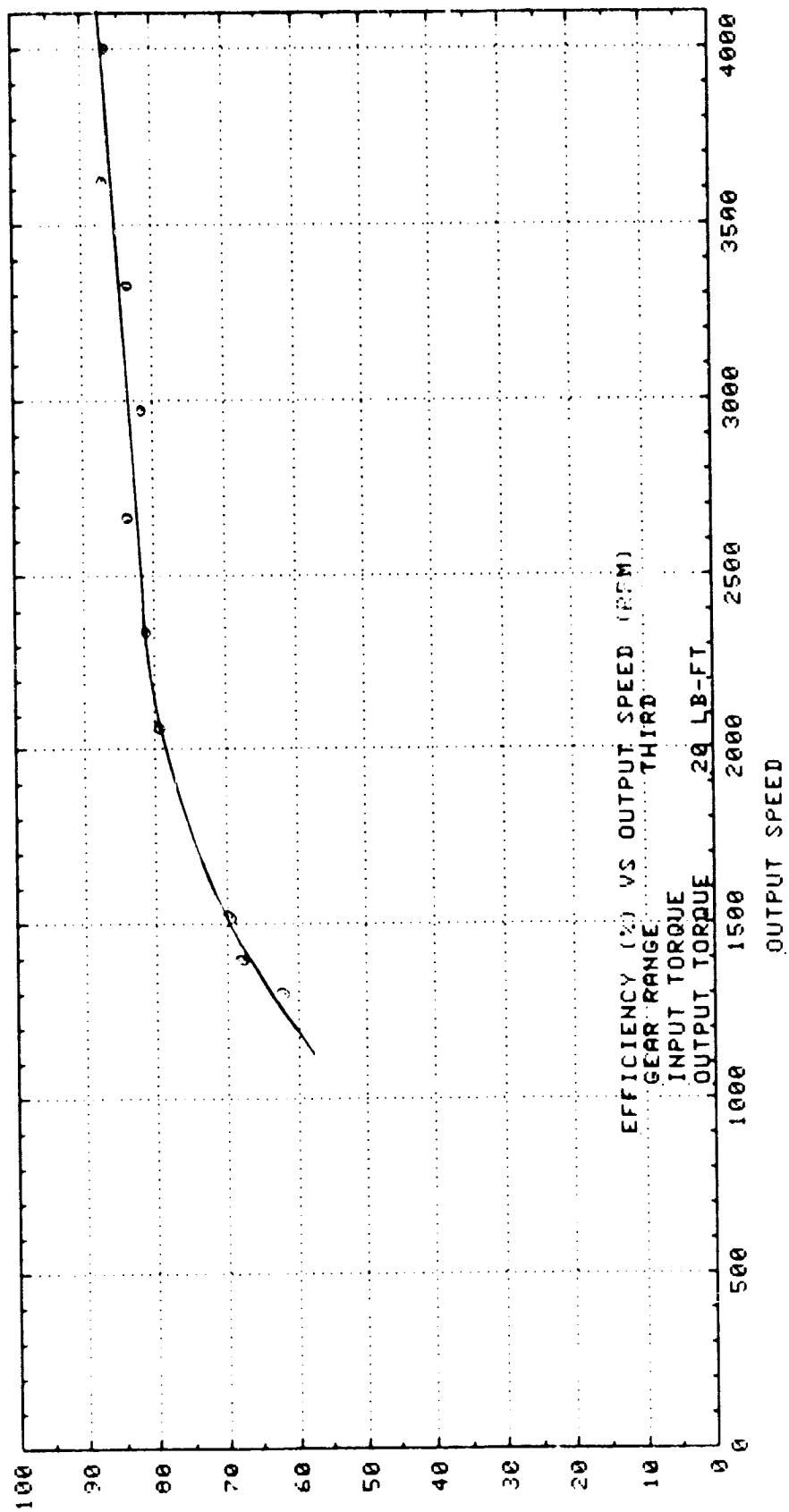

EFFICIENCY

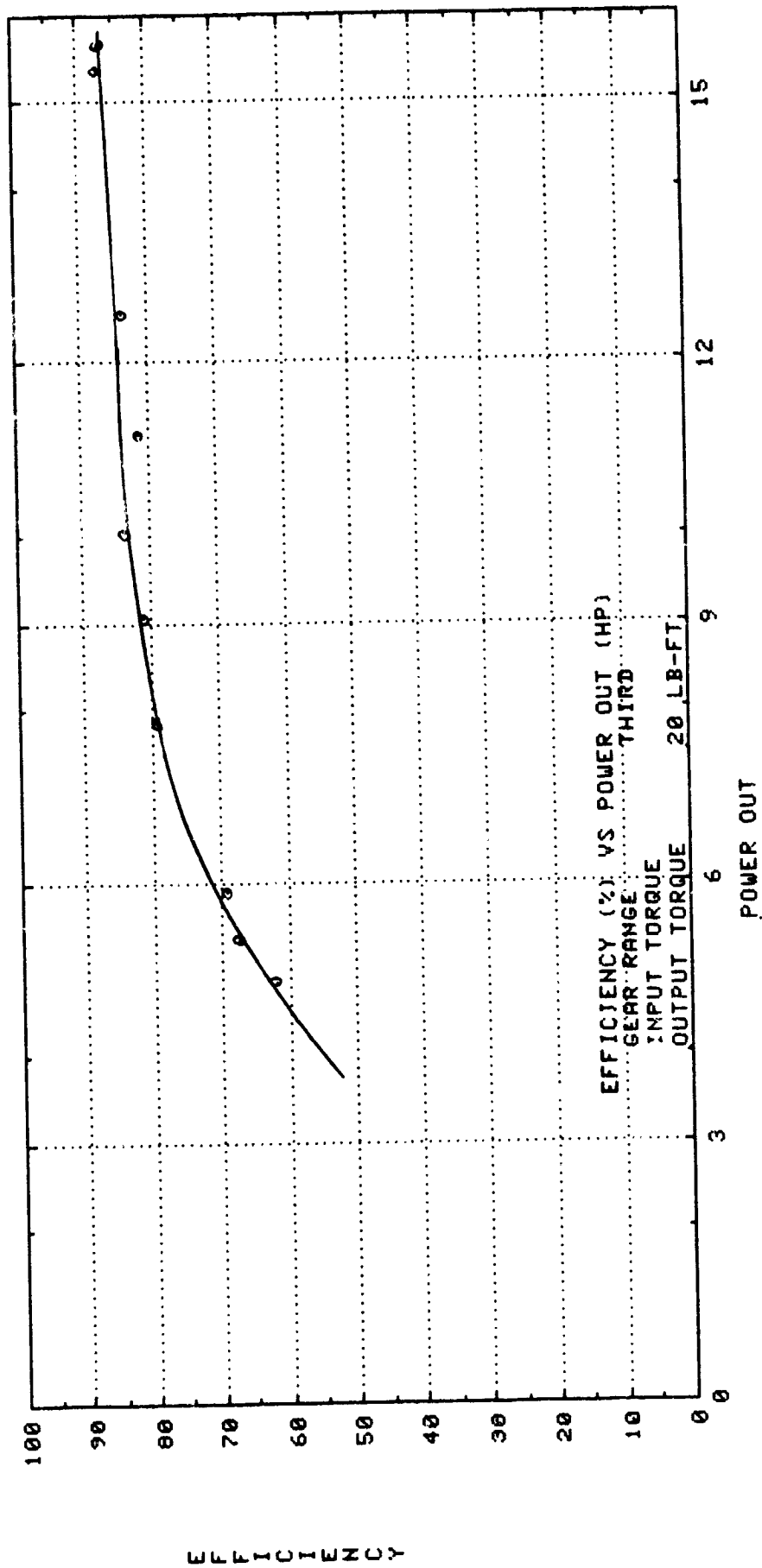

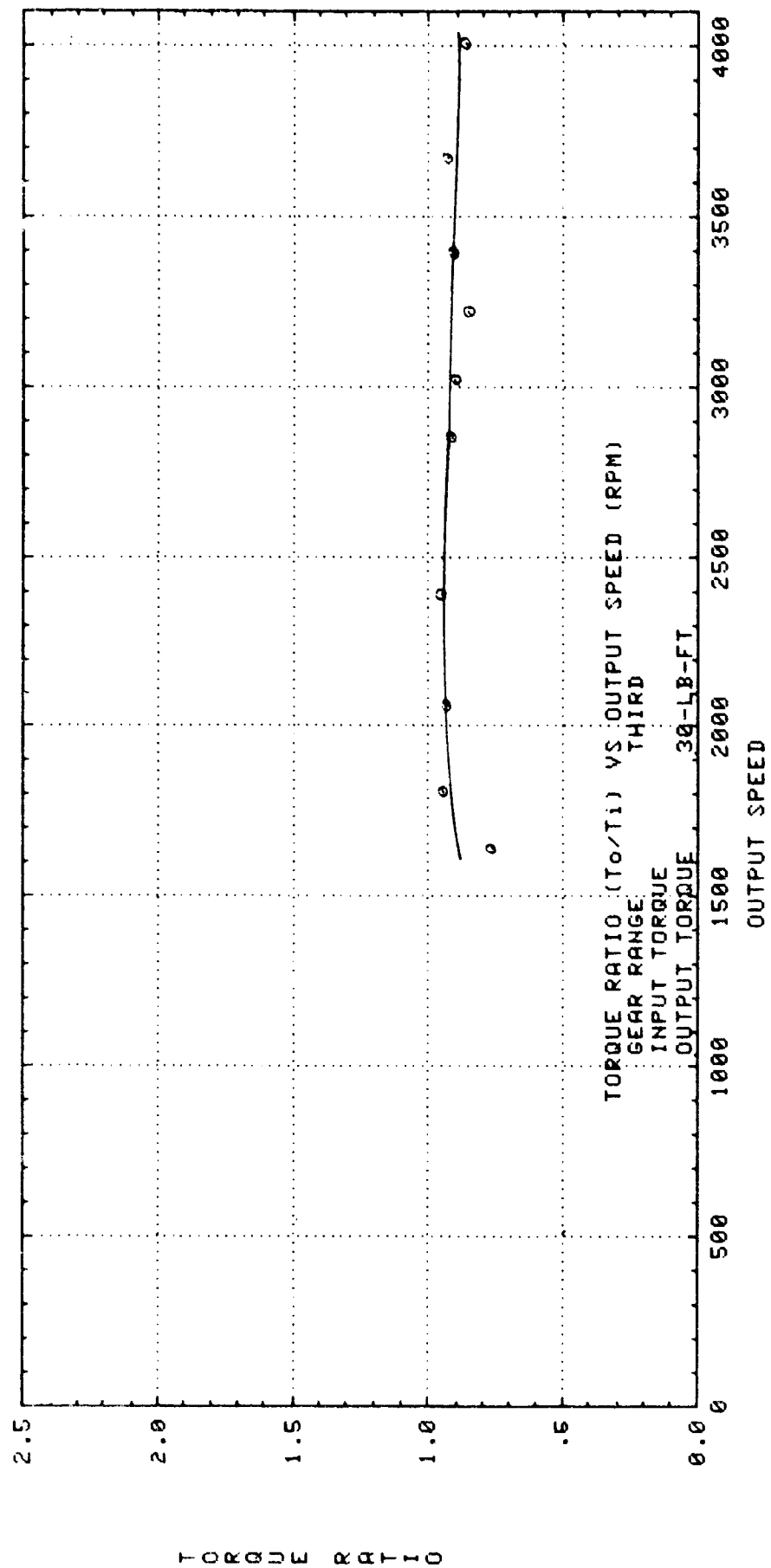

TORQUE RATIO

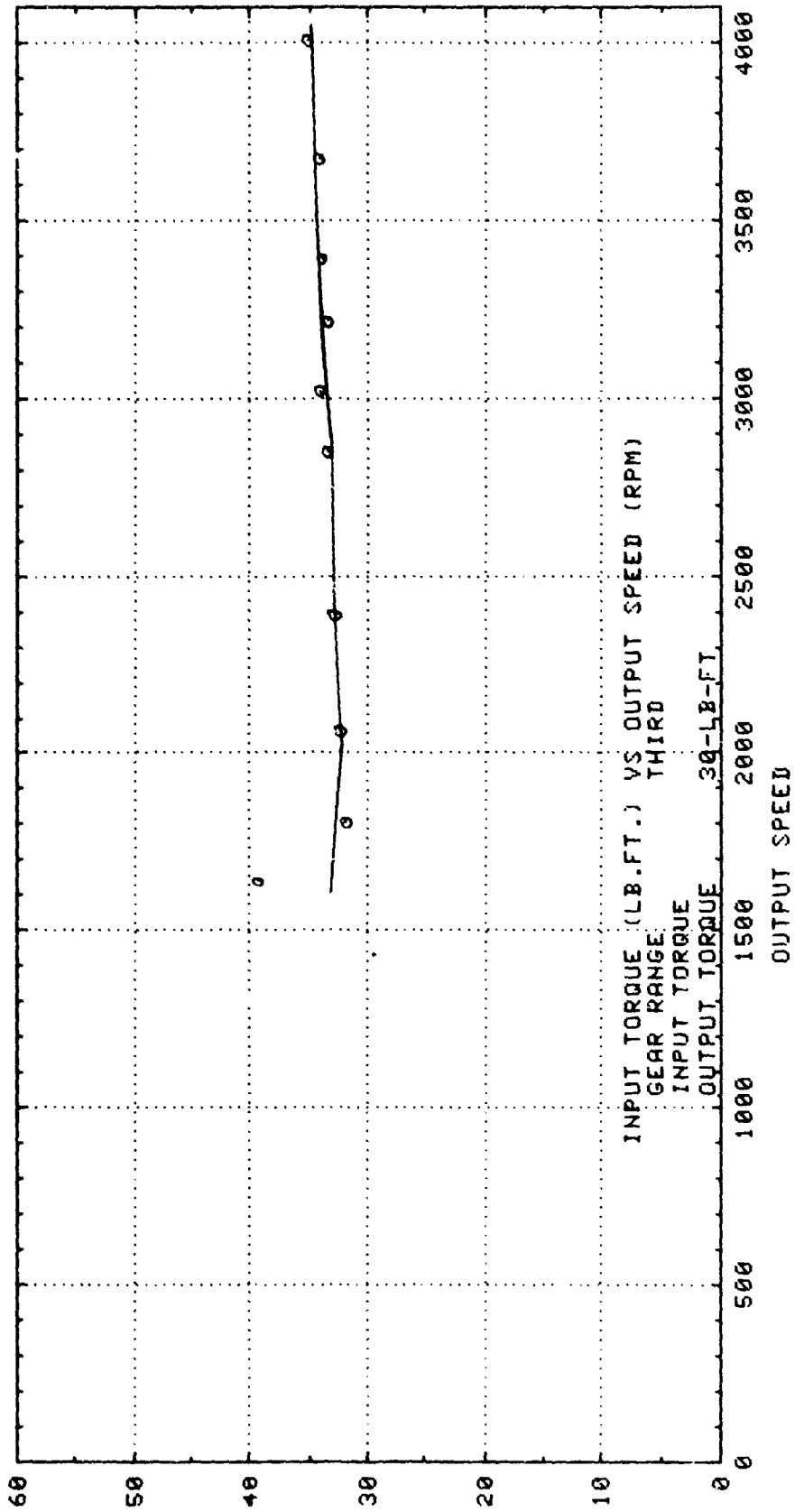

INPUT TORQUE



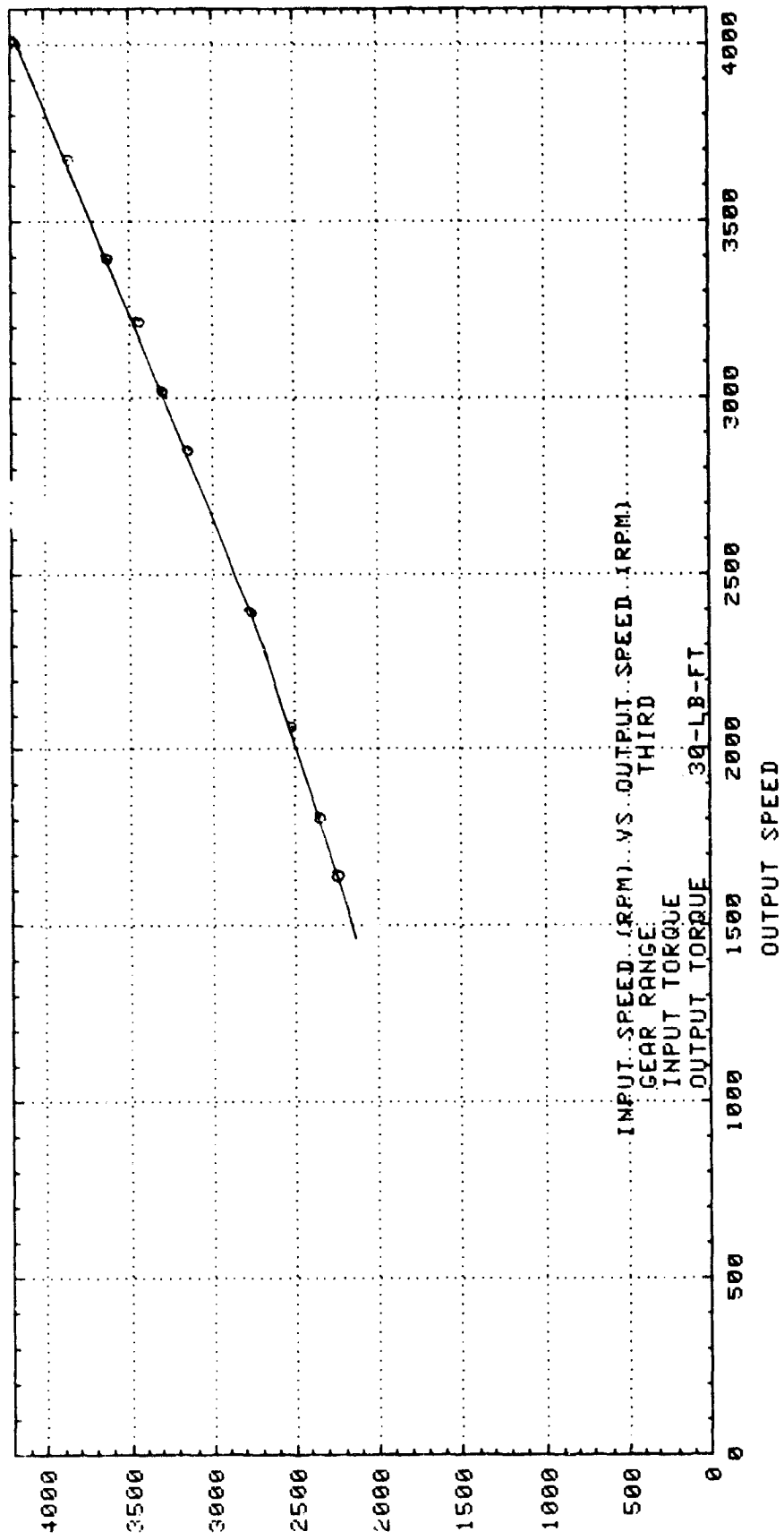

INPUT SPEED

EFFICIENCY

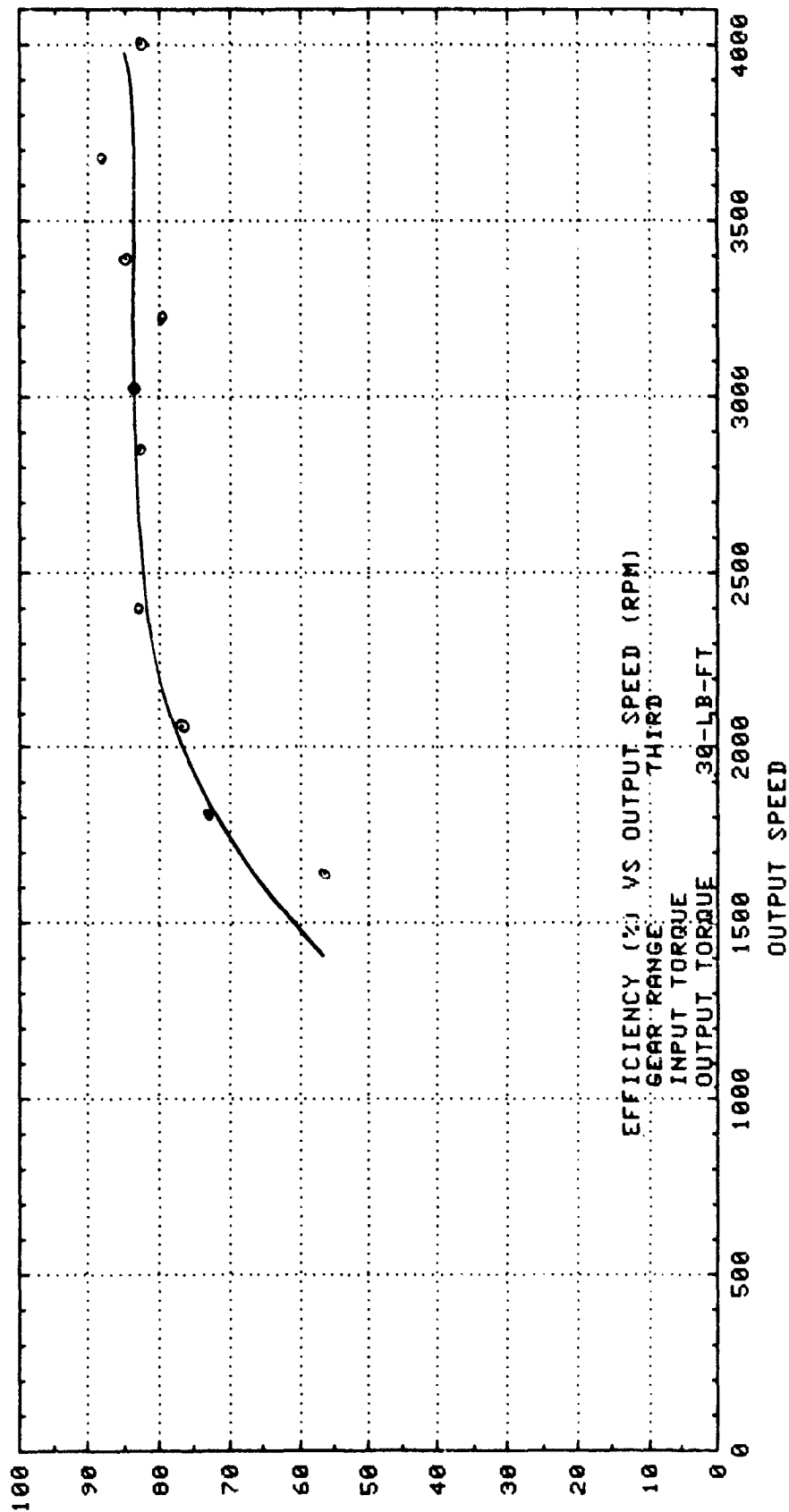

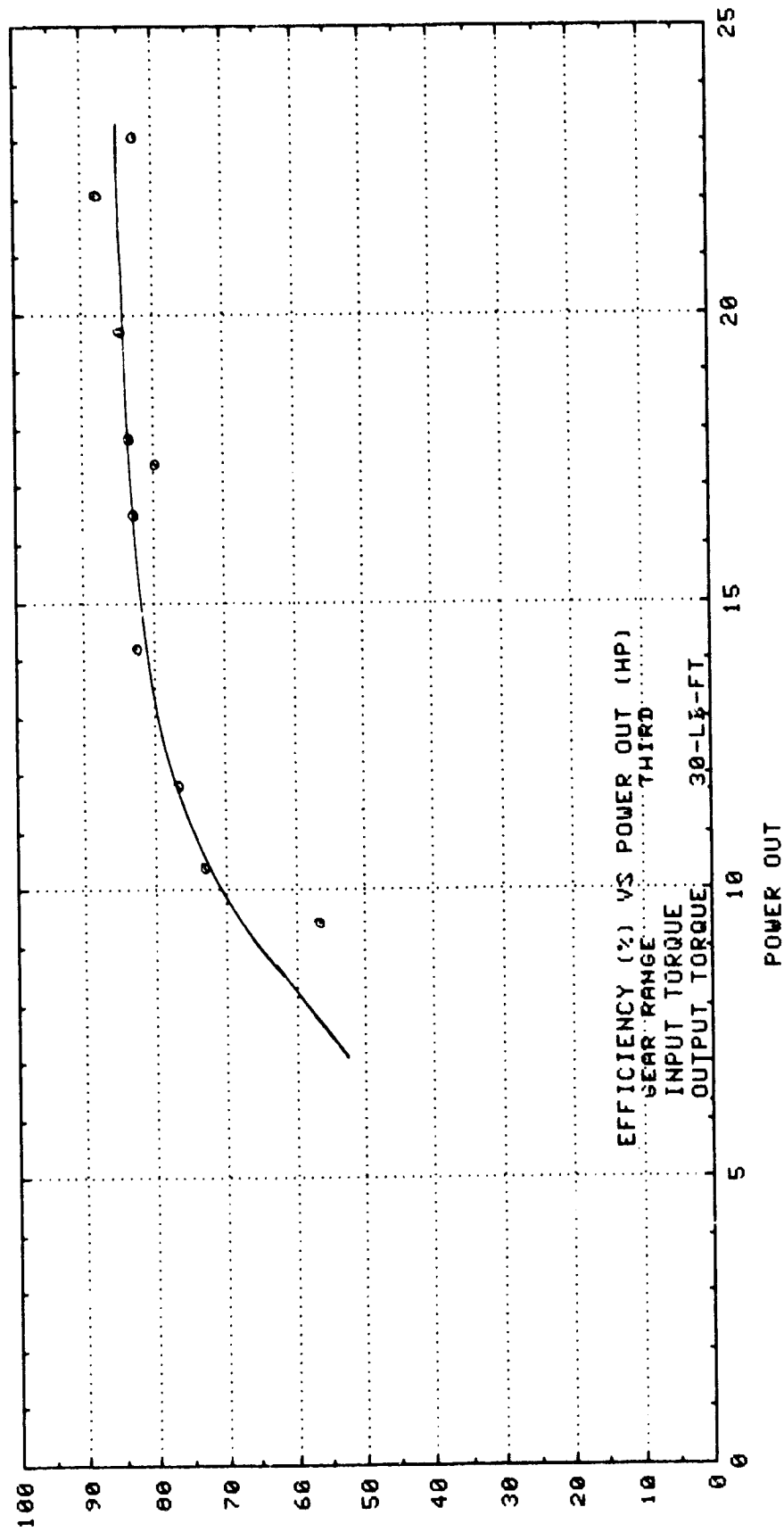

EFFICIENCY

TORQUE RATIO

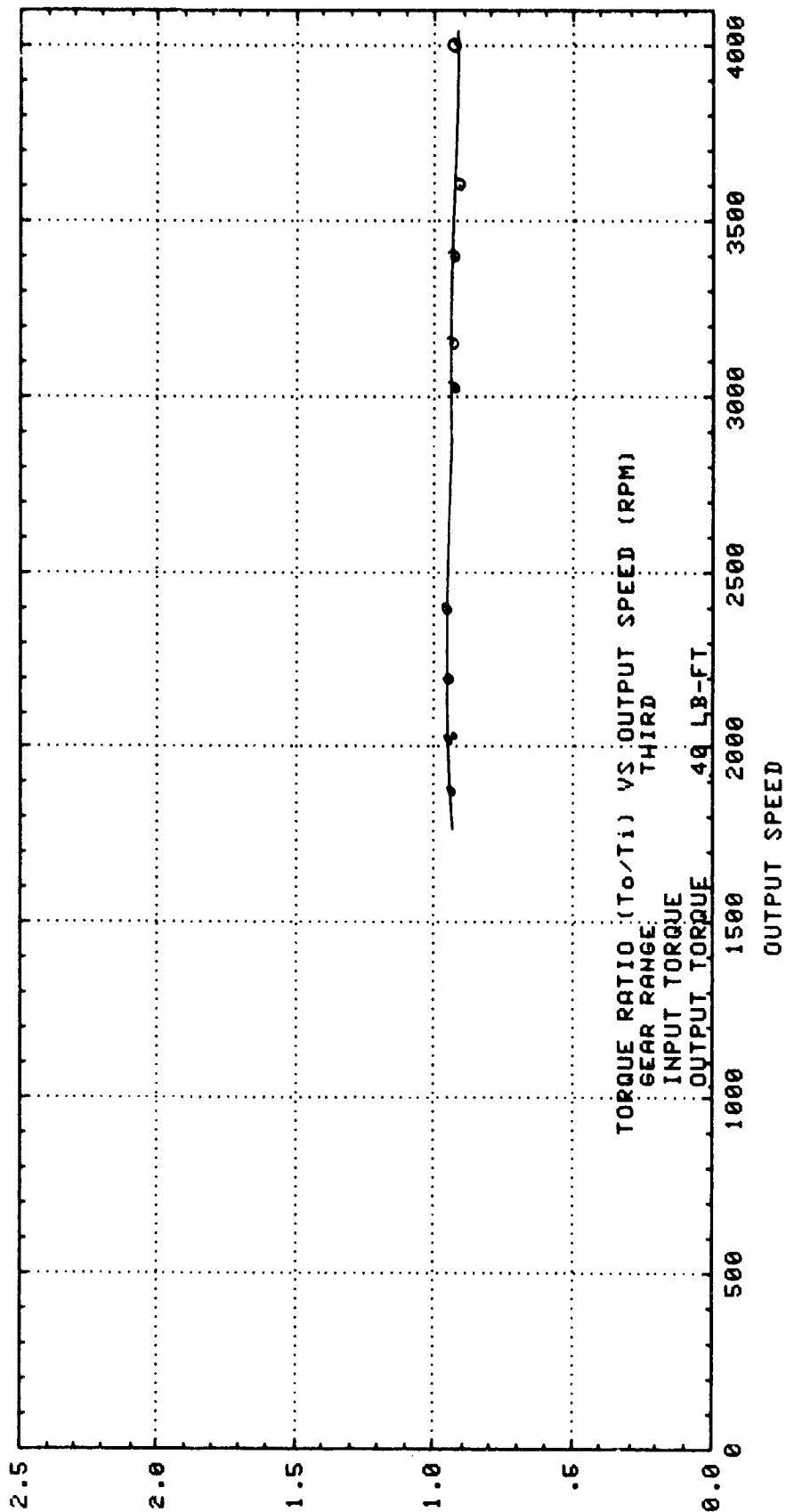

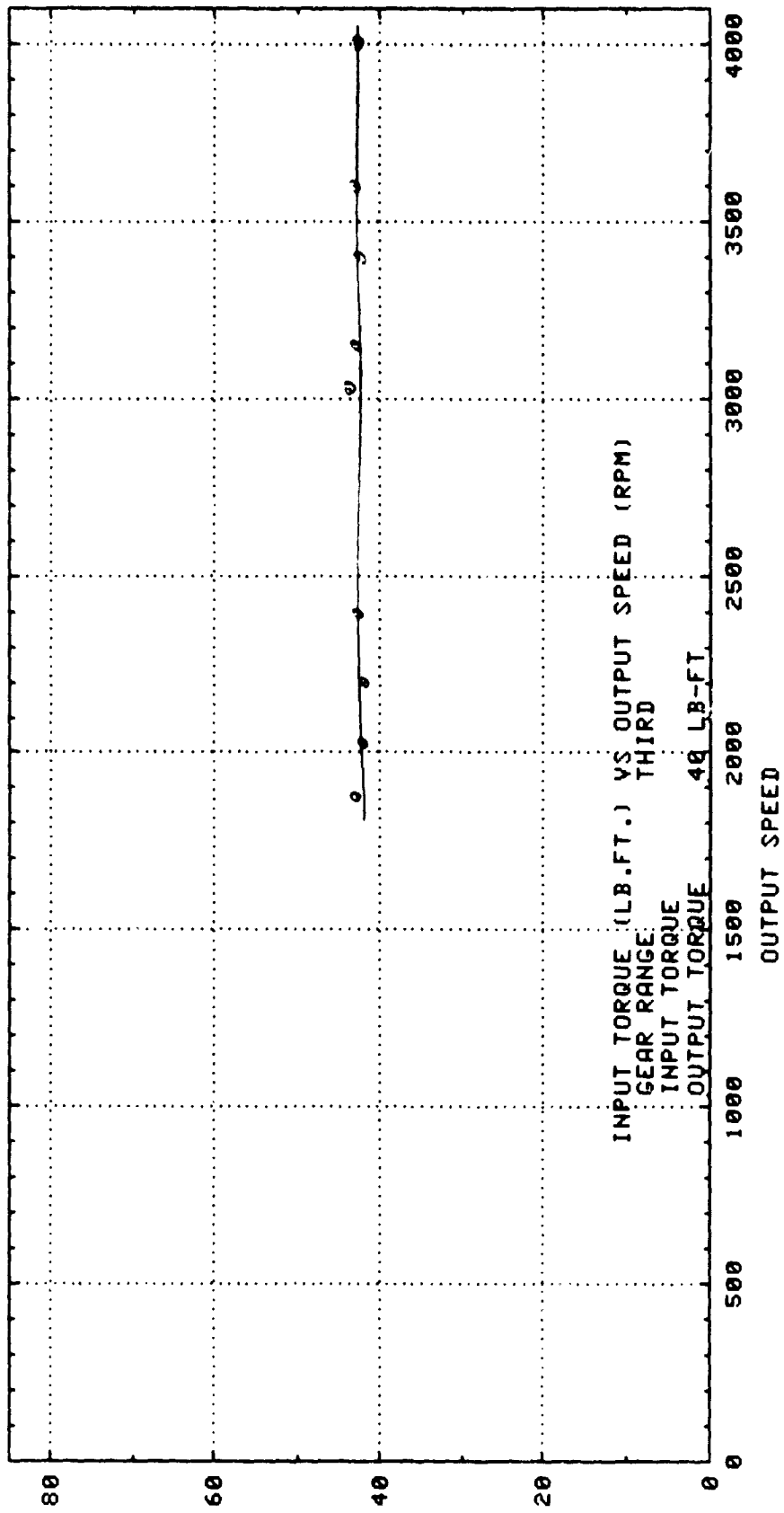

INPUT TORQUE

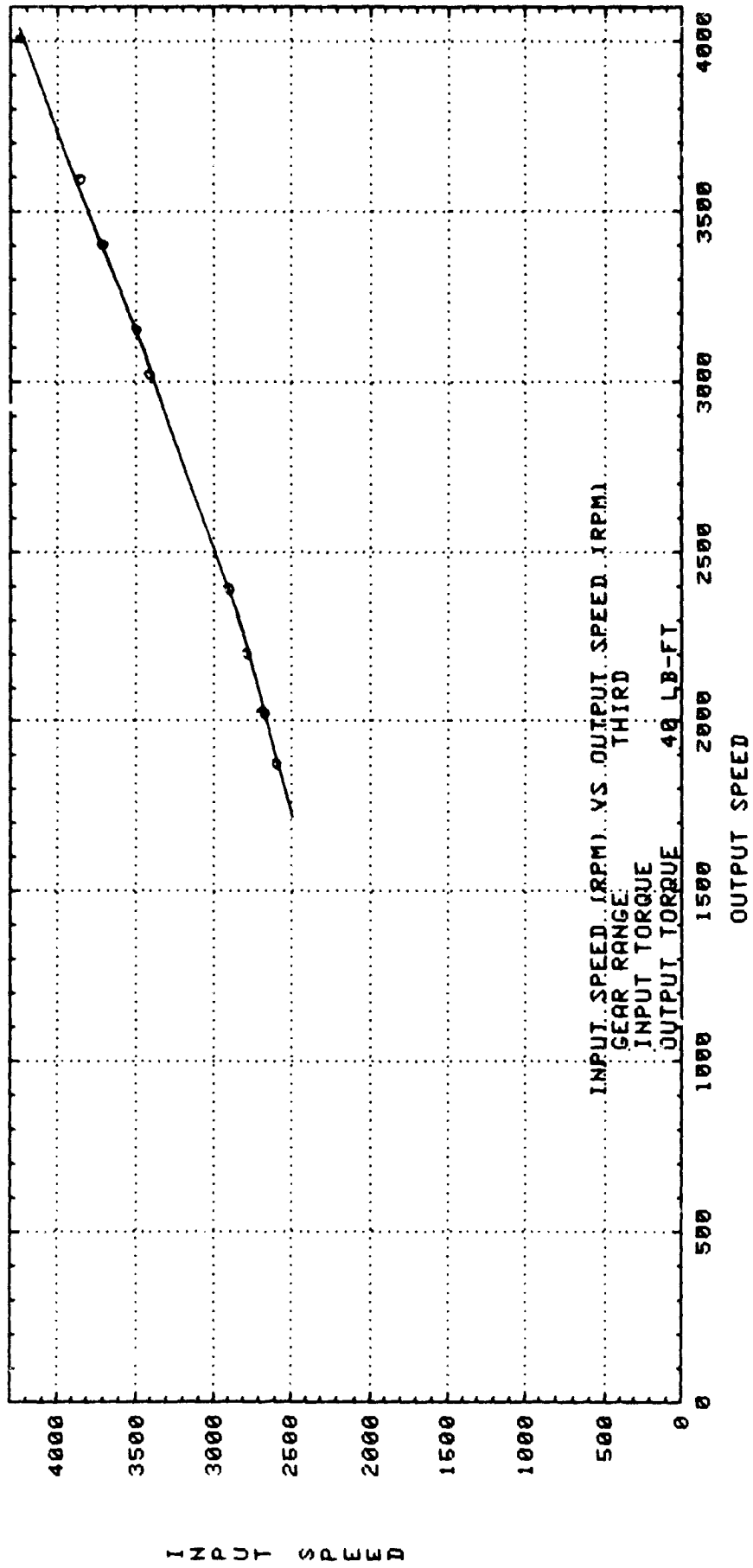

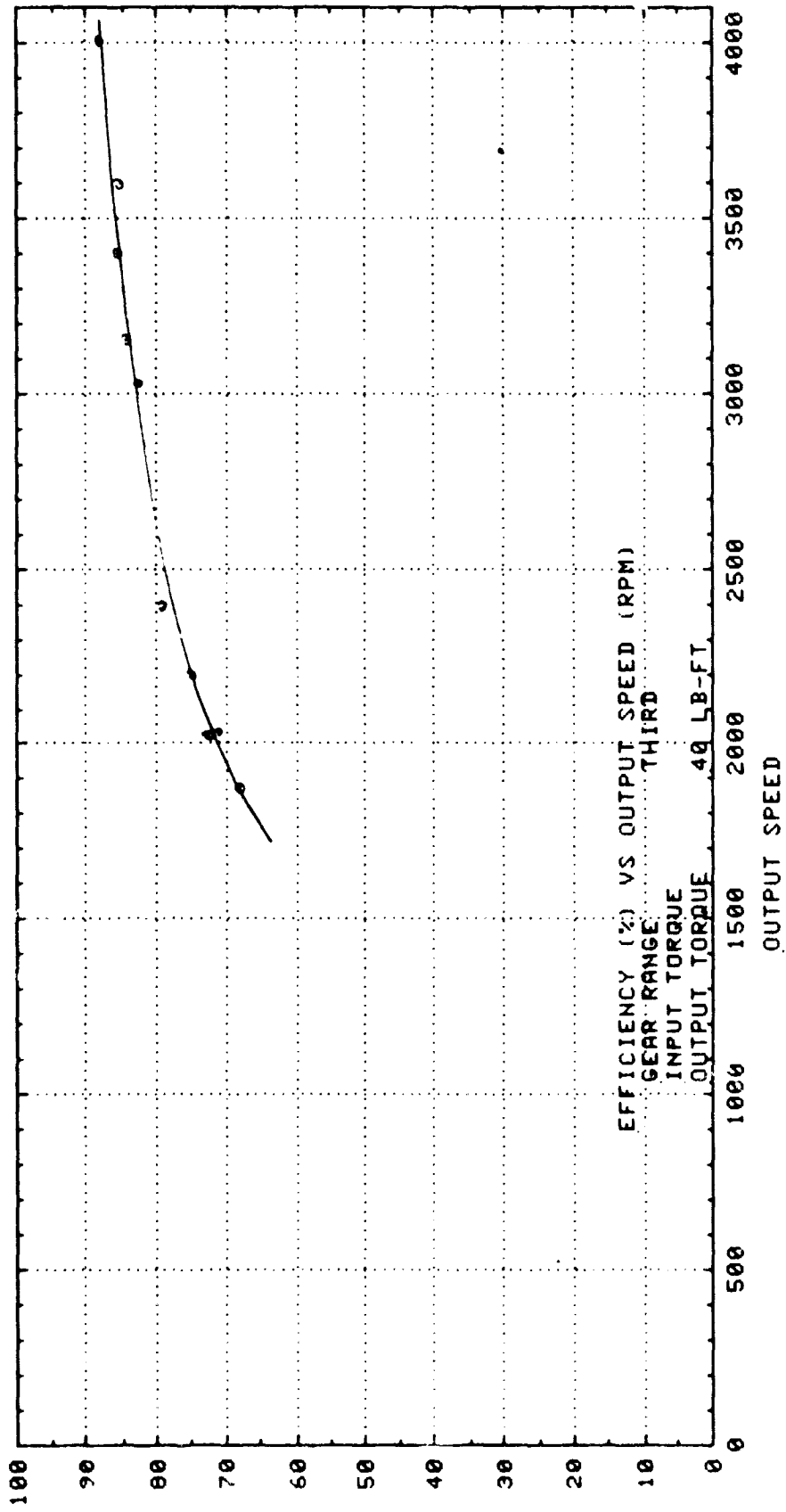

EFFICIENCY

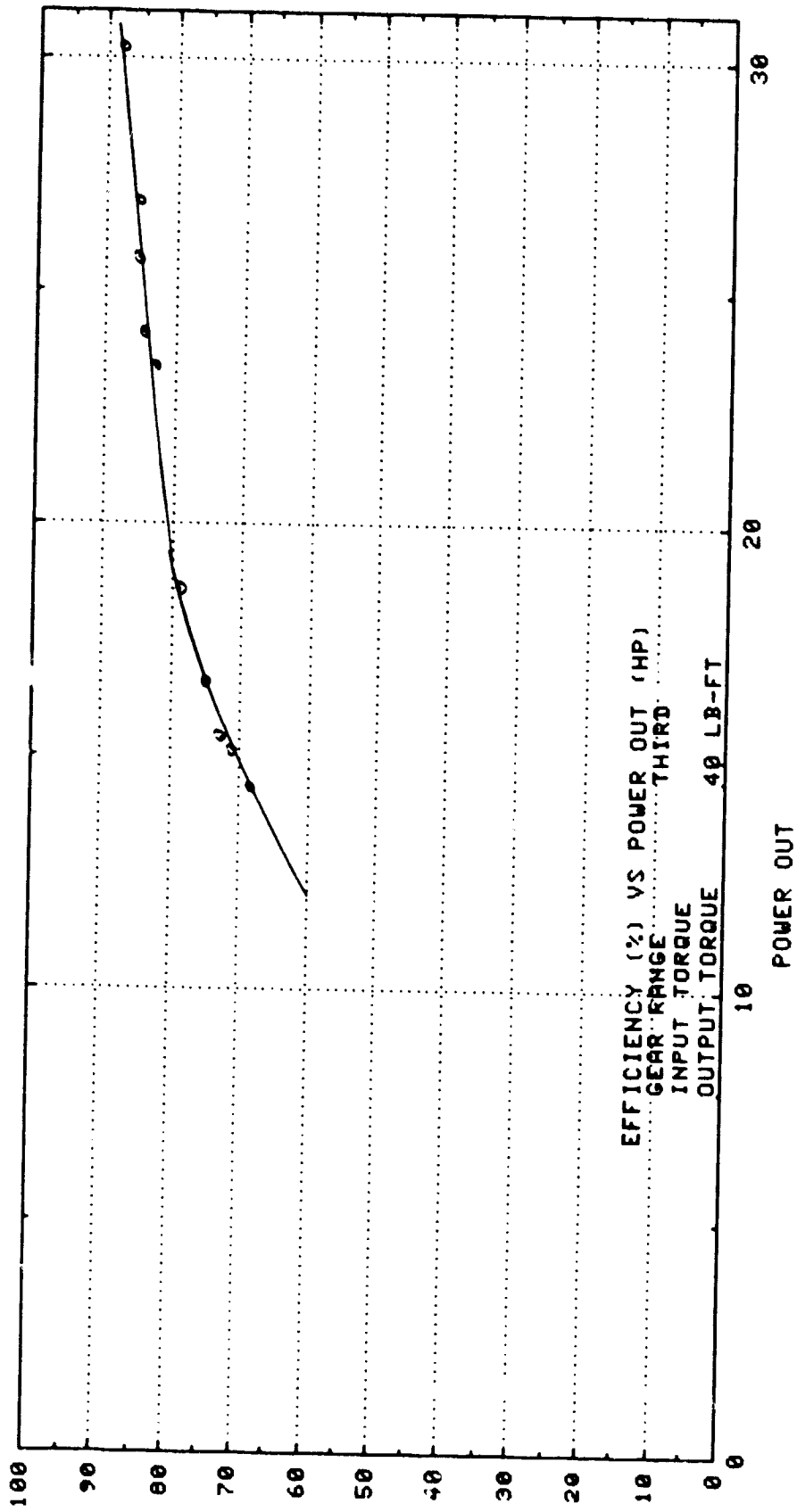



TORQUE RATIO

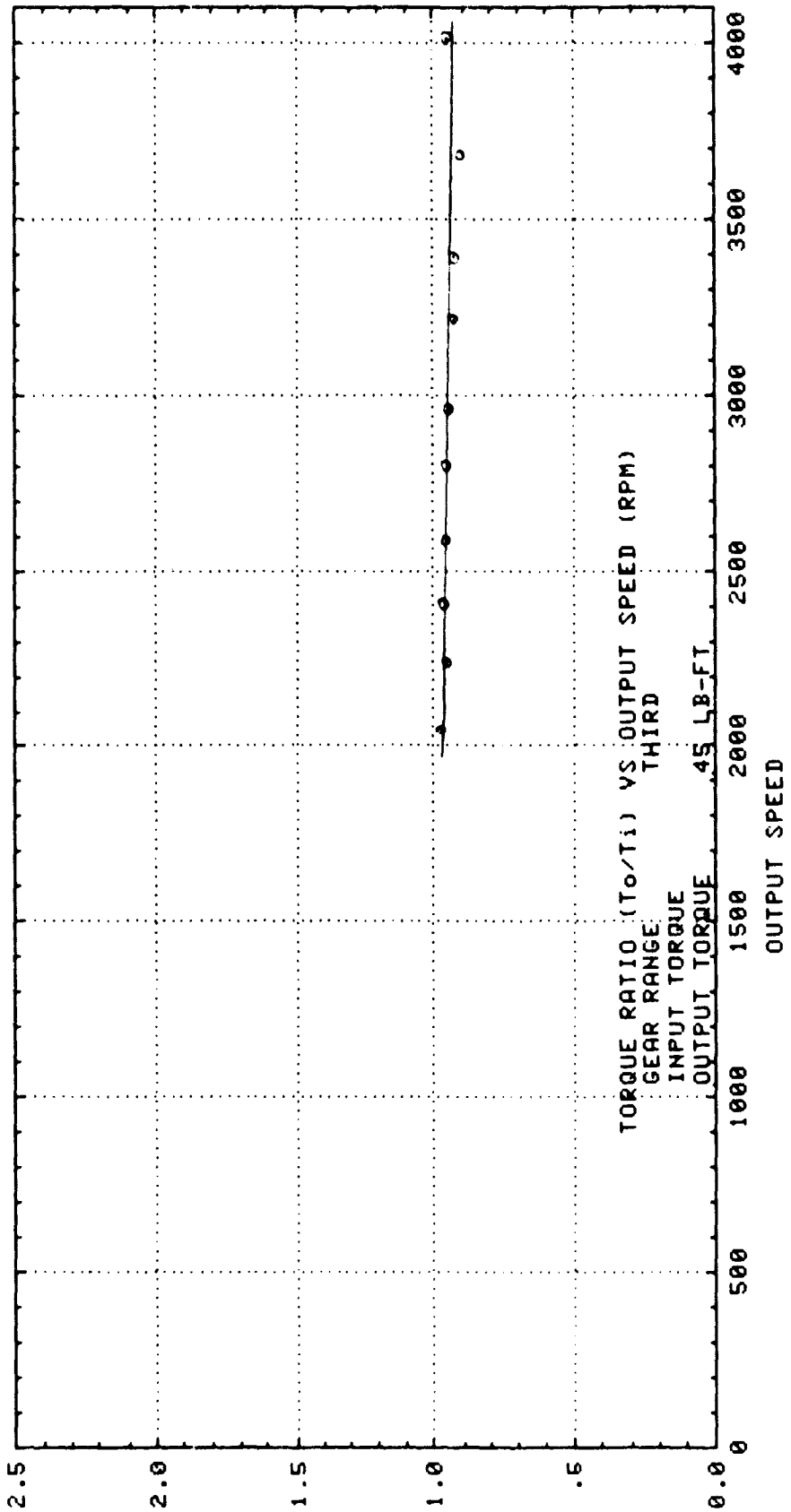

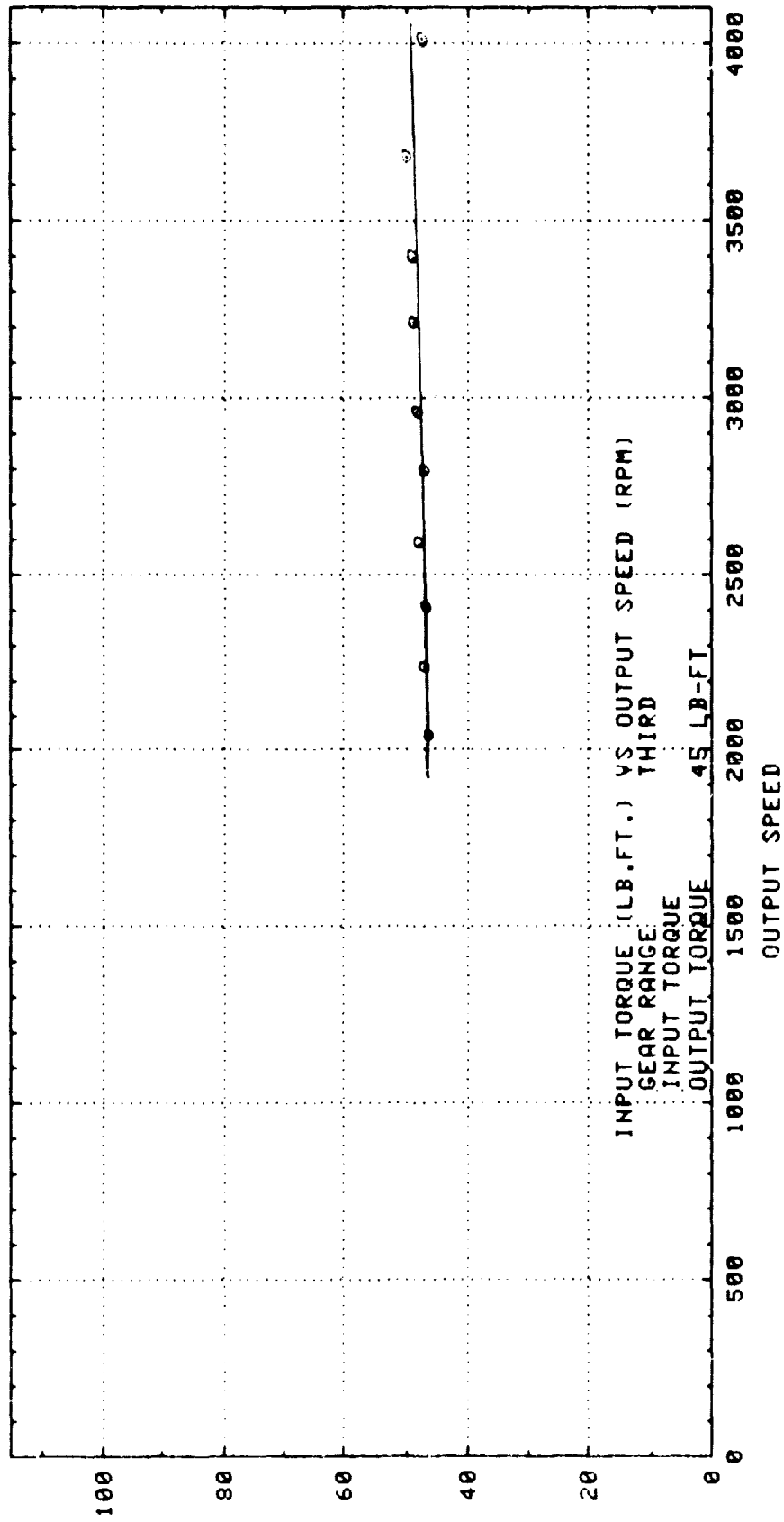

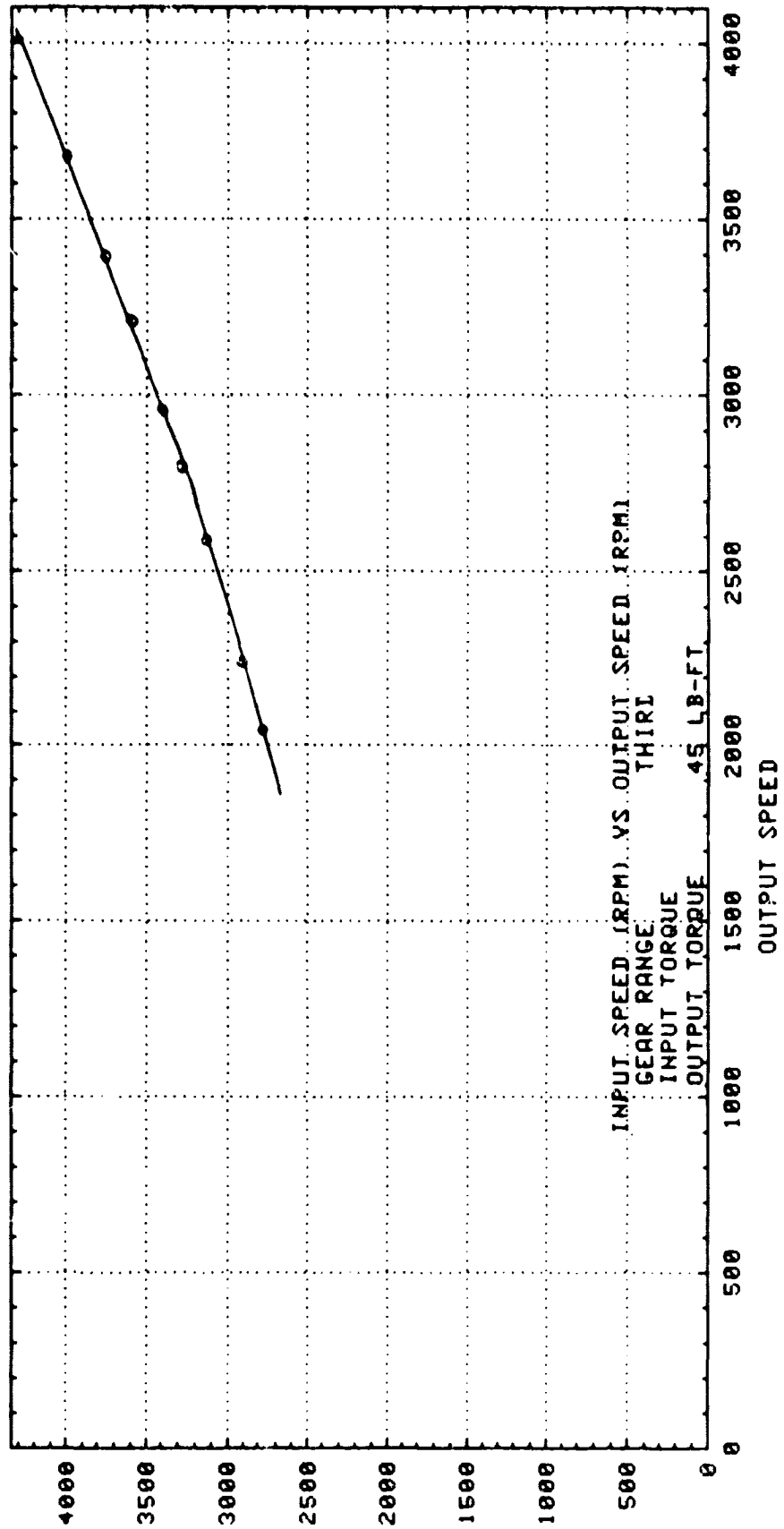

INPUT SPEED

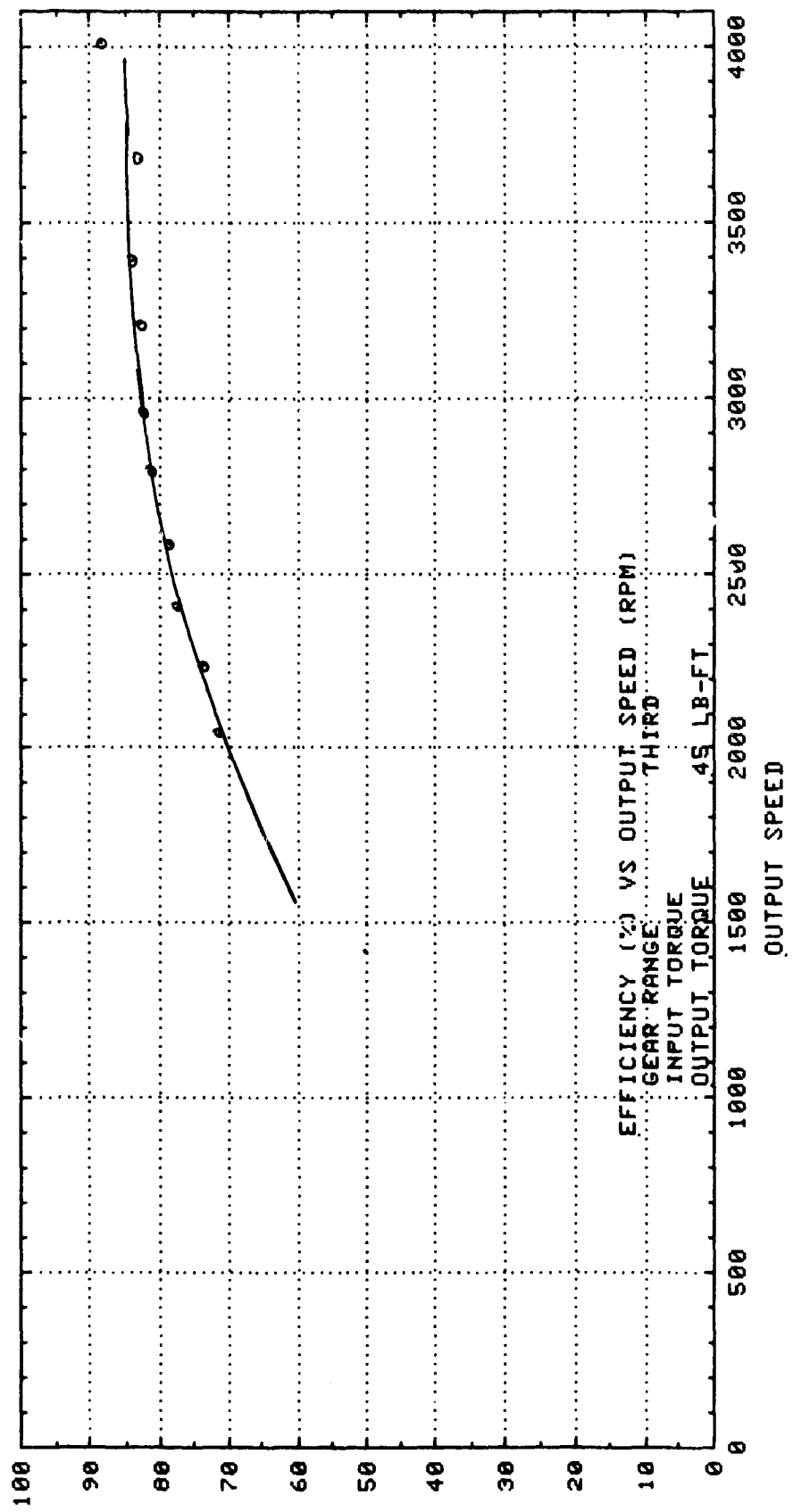

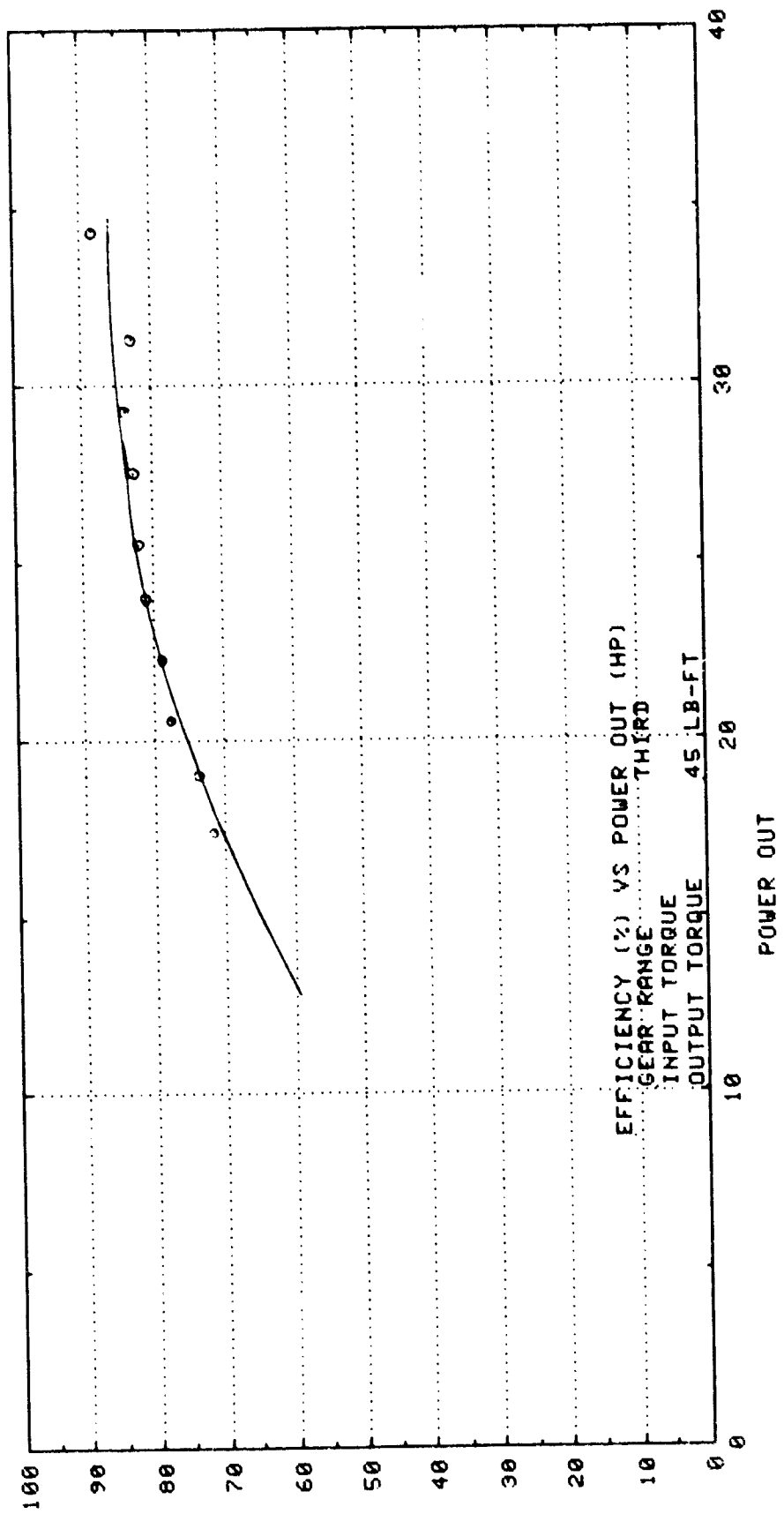

EFFICIENCY

TORQUE RATIO

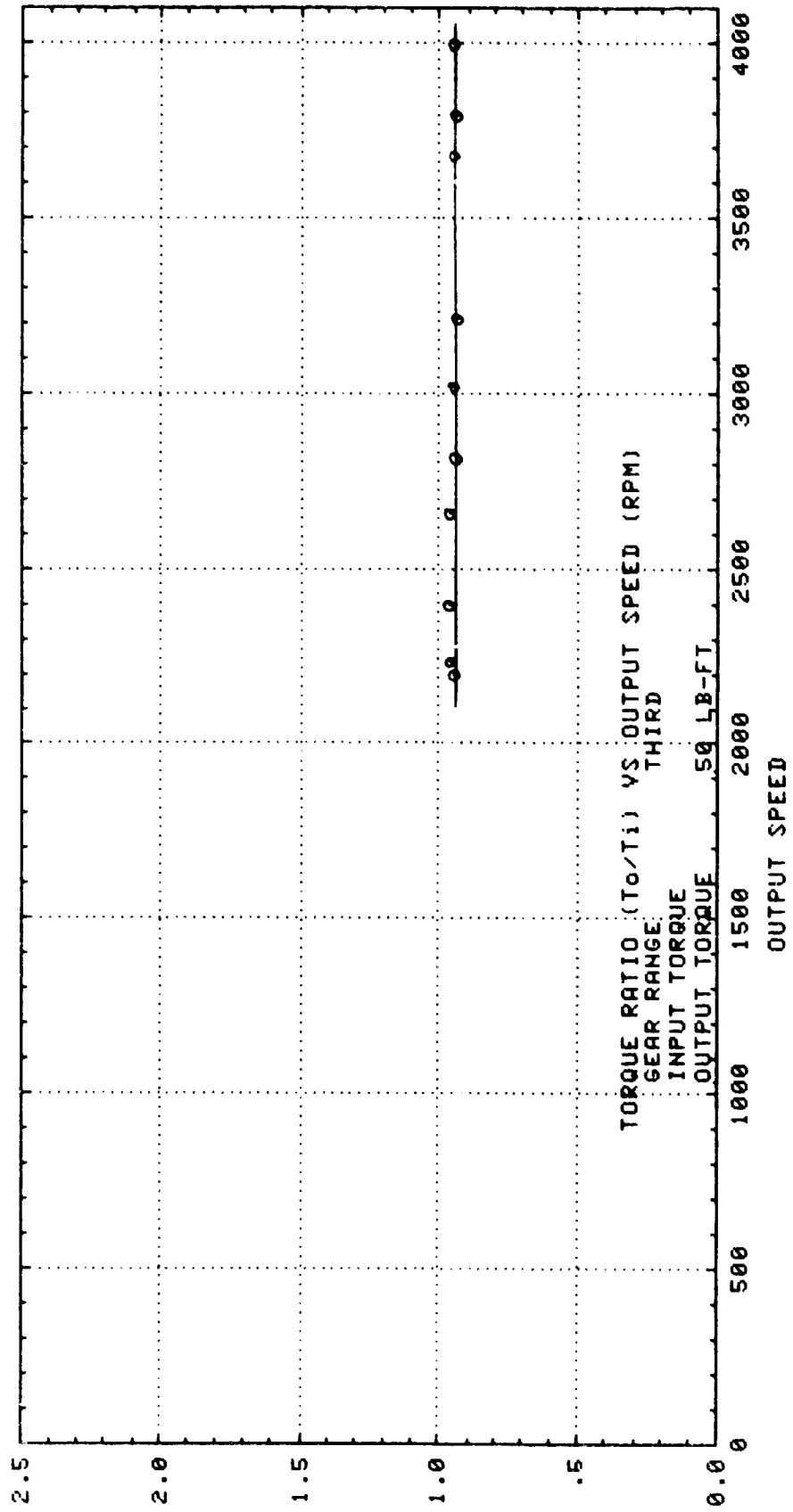

INPUT TORQUE

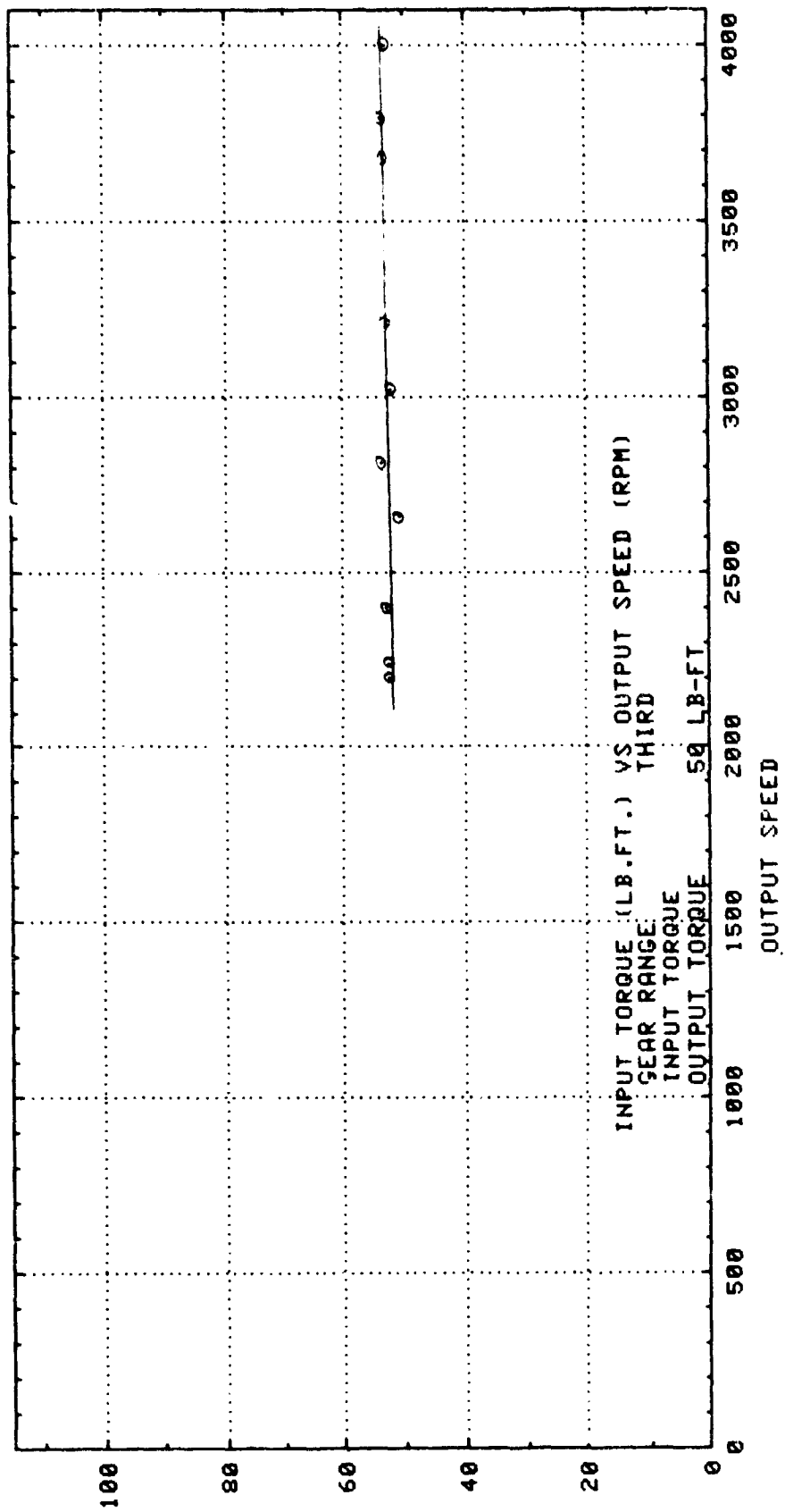

INPUT SPEED

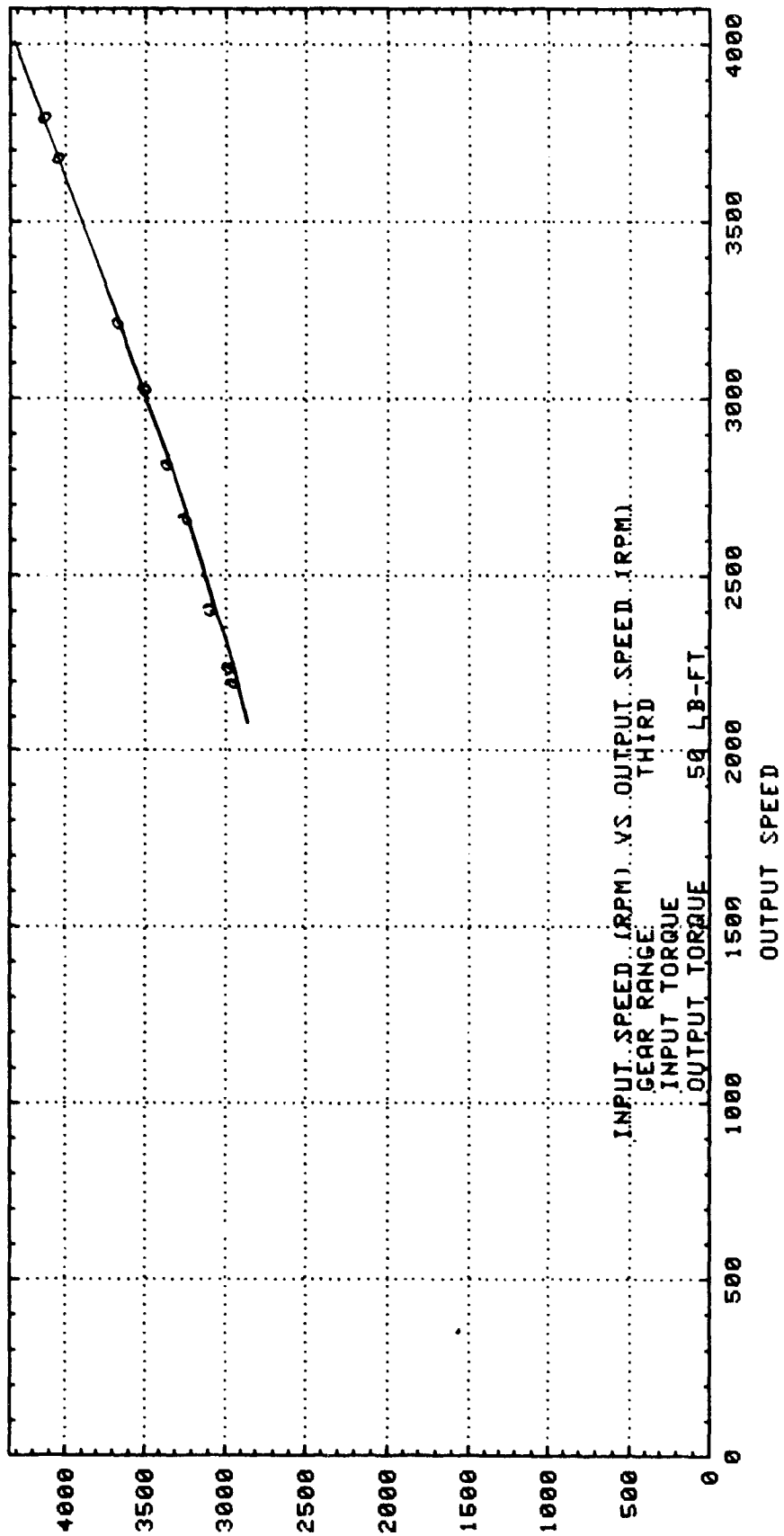



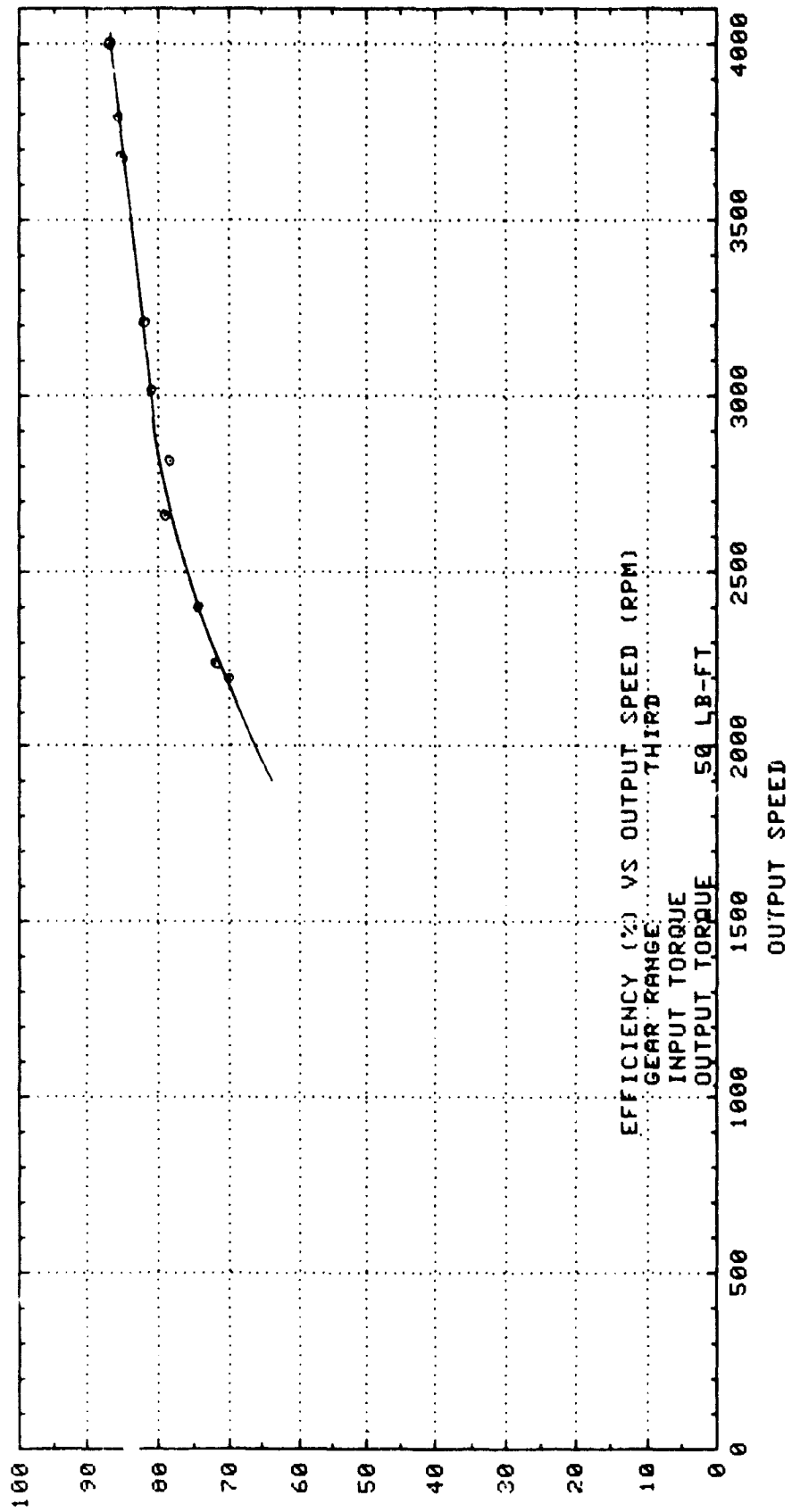

EFFICIENCY

EFFICIENCY

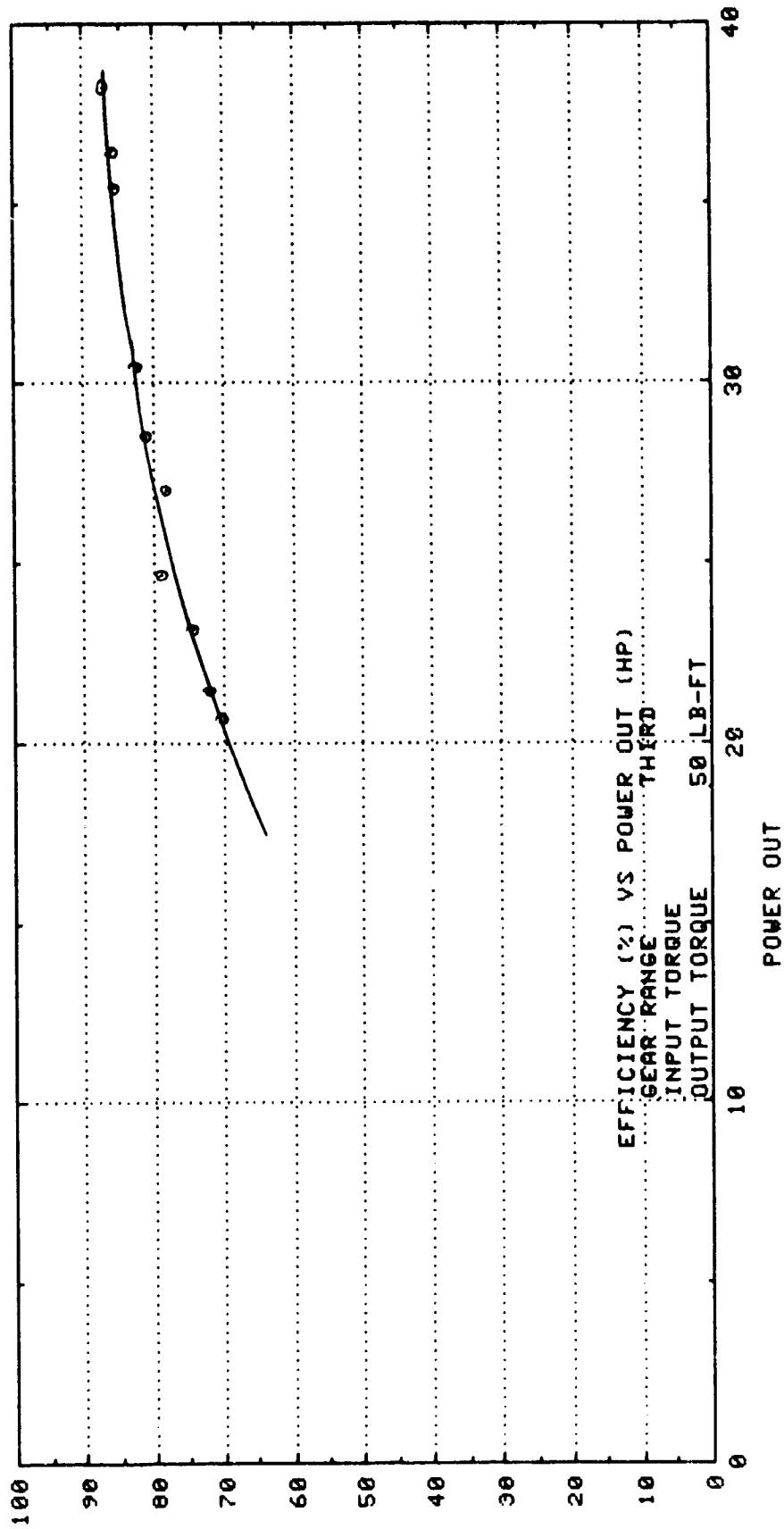

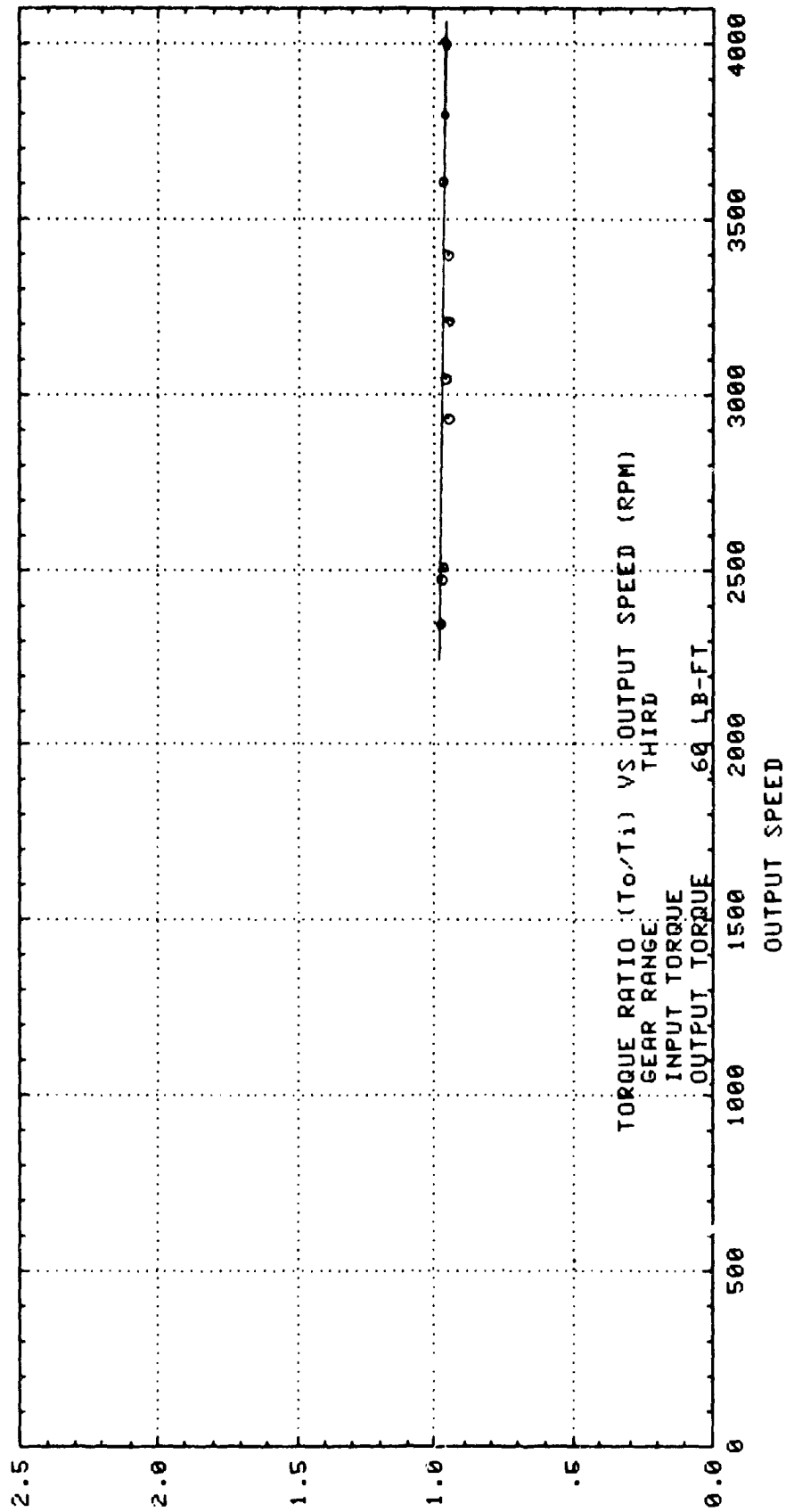

T O R Q U E   R A T I O

INPUT TORQUE

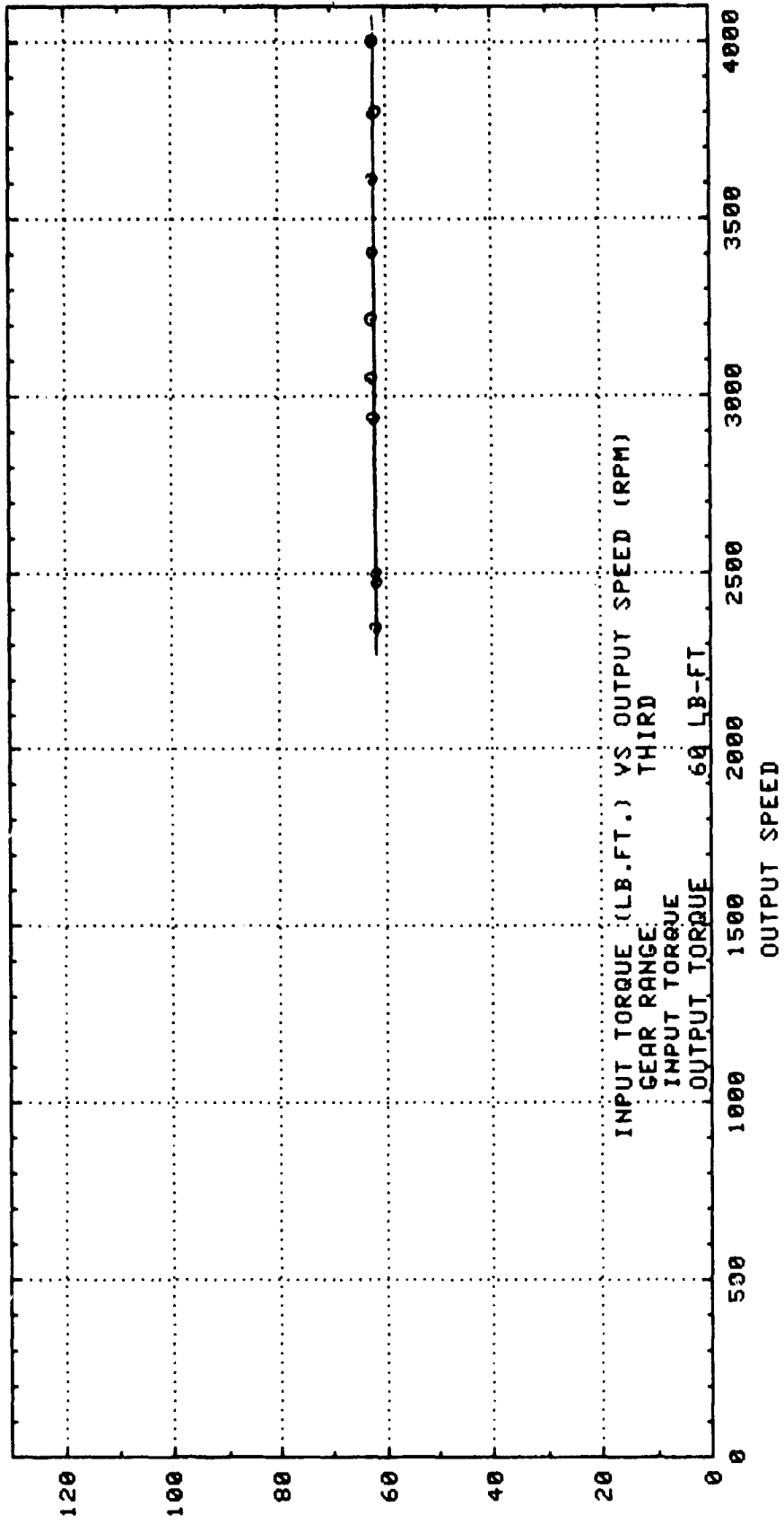

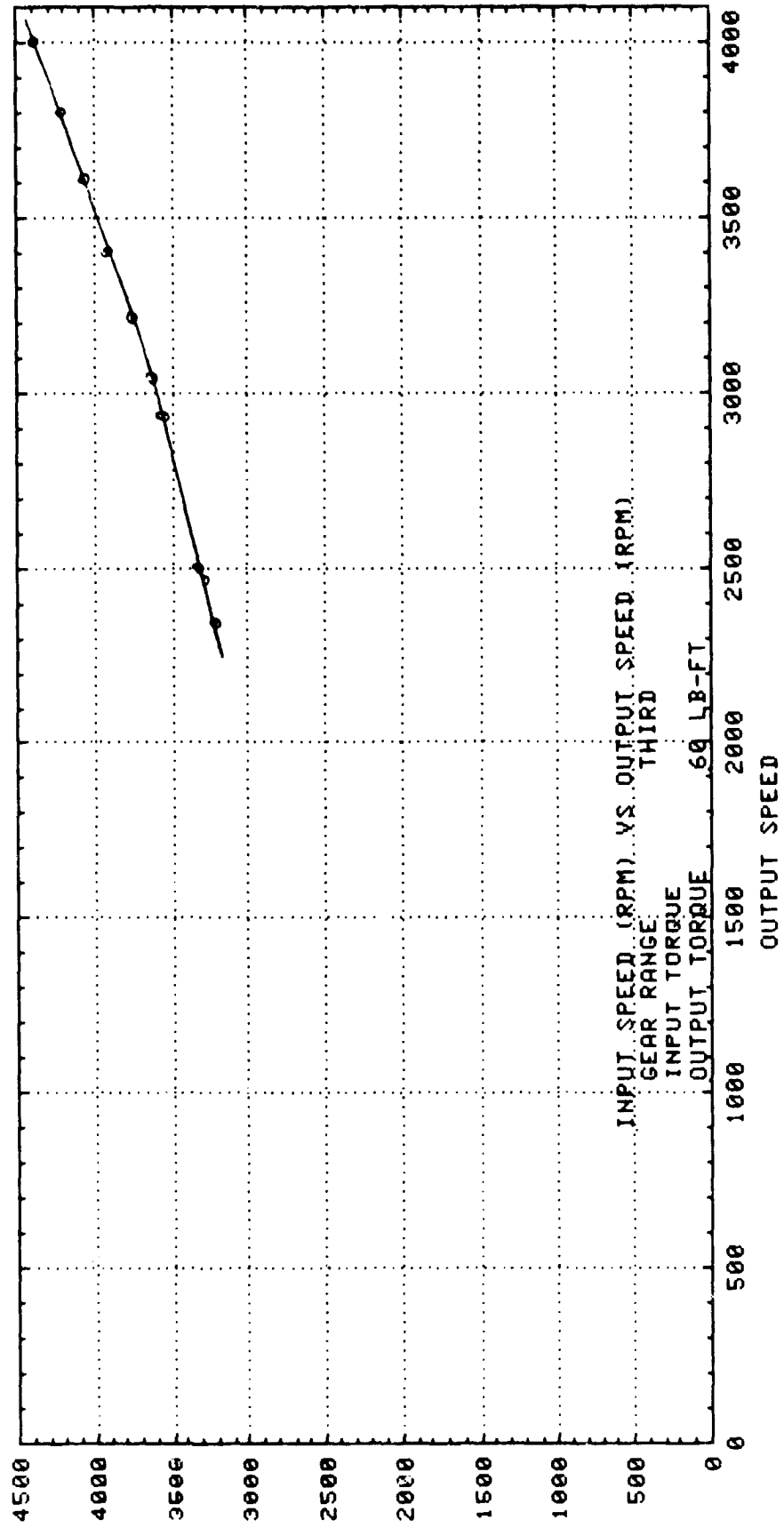

INPUT SPEED

EFFICIENCY

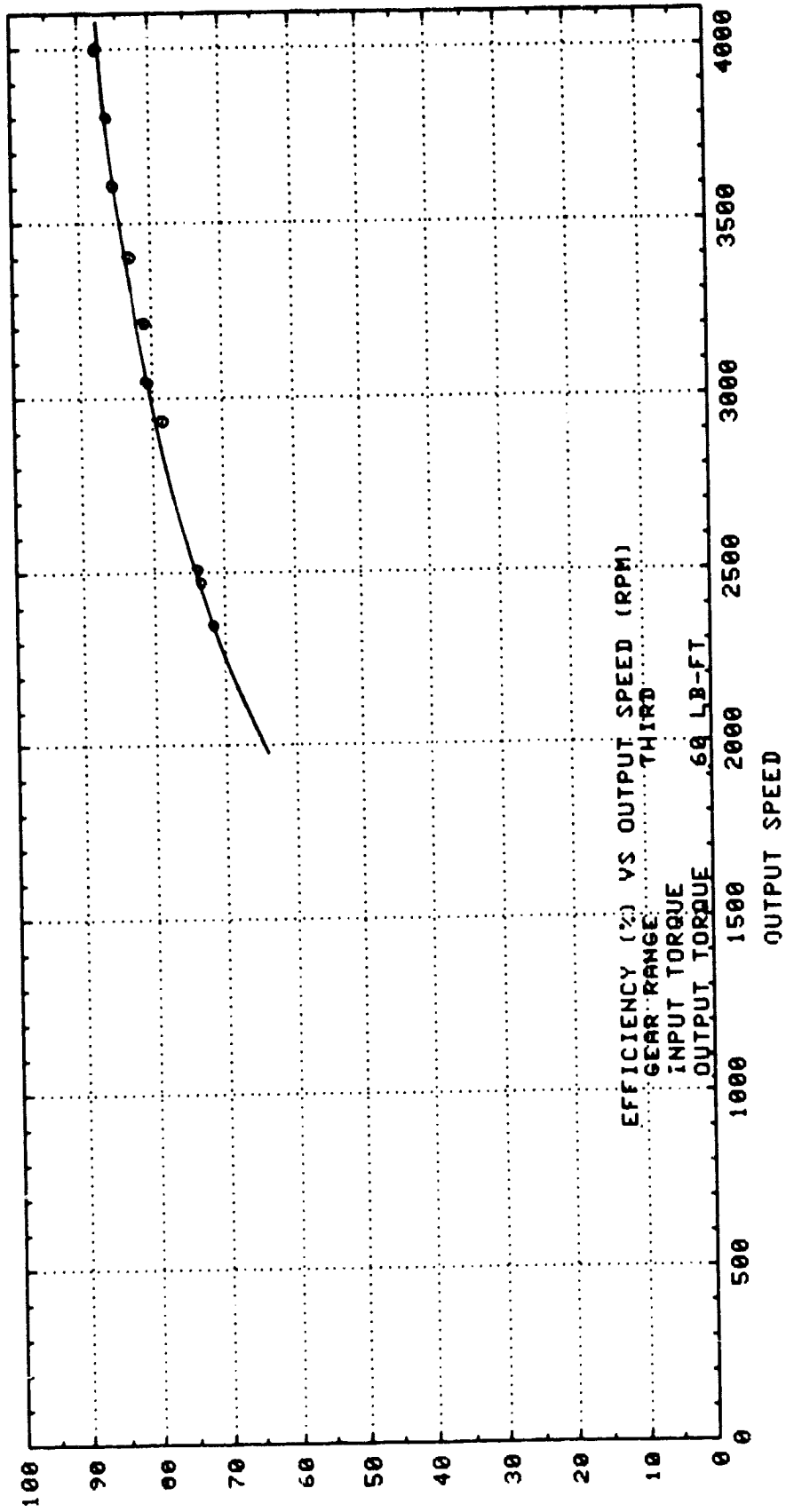

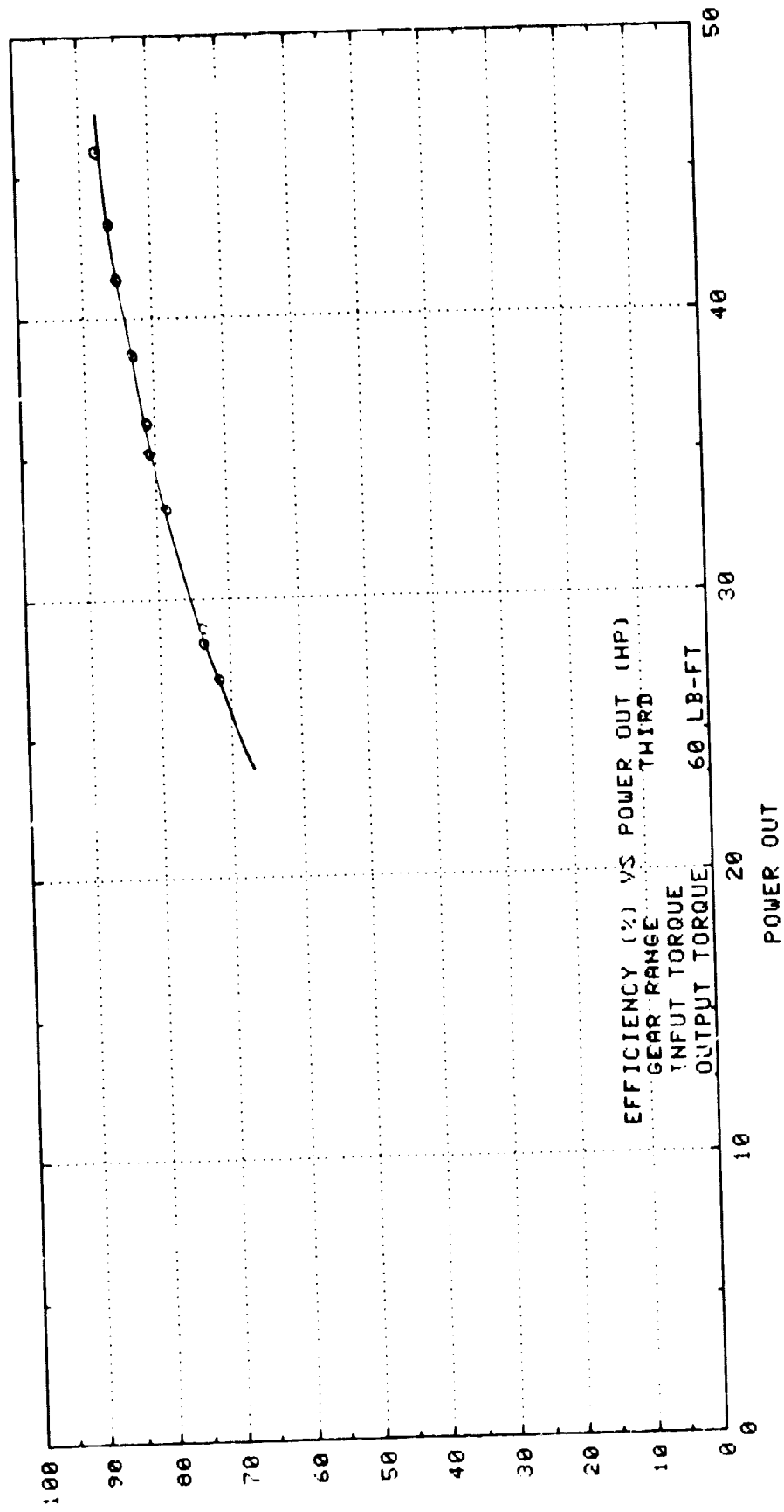

EFFICIENCY

**NO LOAD LOSSES**  
**1st Gear (Closed Throttle)**



Graphs Contained in This Section

Torque Loss -vs- Input Speed

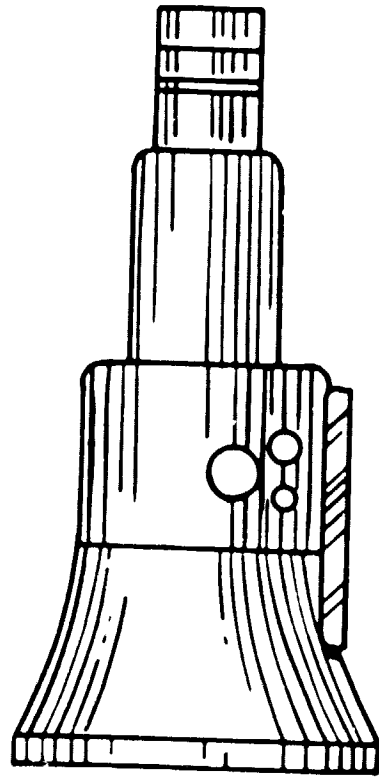

Torque In

Speed In

---

No Load Losses

TORQUE LOSS

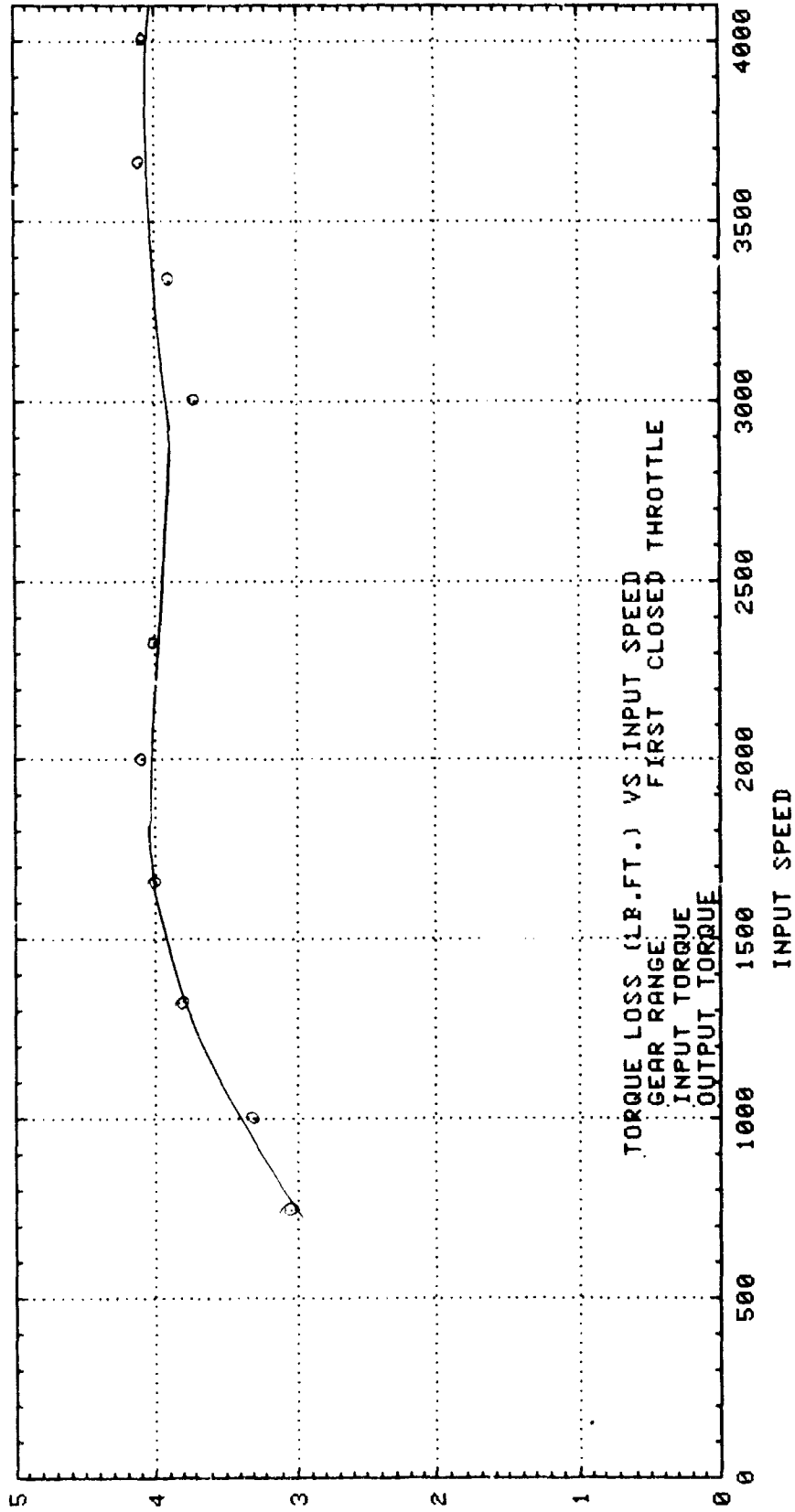

NO LOAD LOSSES  
1st Gear (Open Throttle)

TORQUE LOSS

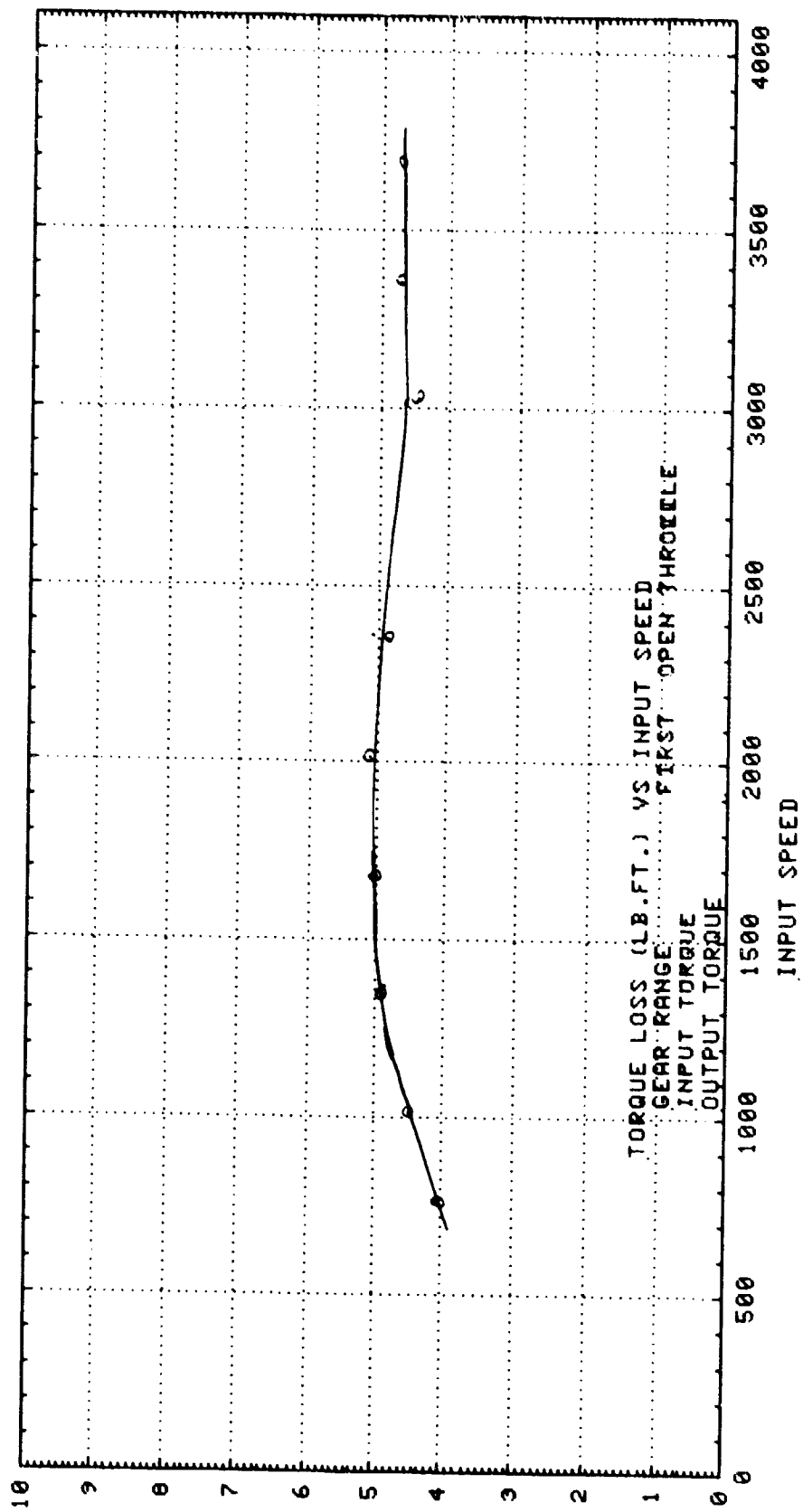

NO LOAD LOSSES  
2nd Gear (Closed Throttle)

TORQUE LOSS

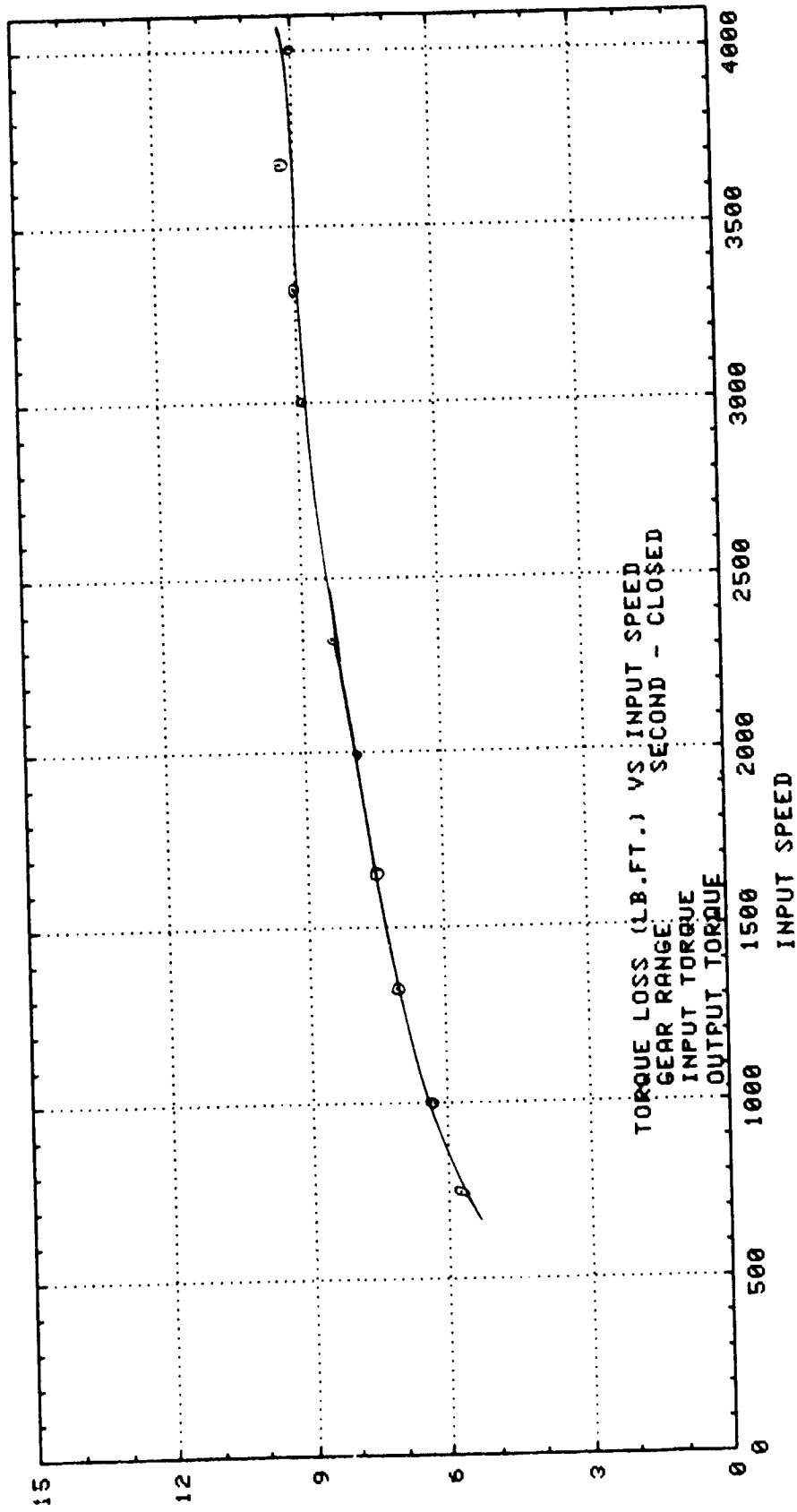

**NO LOAD LOSSES**  
**2nd Gear (Open Throttle)**

TORQUE LOSS

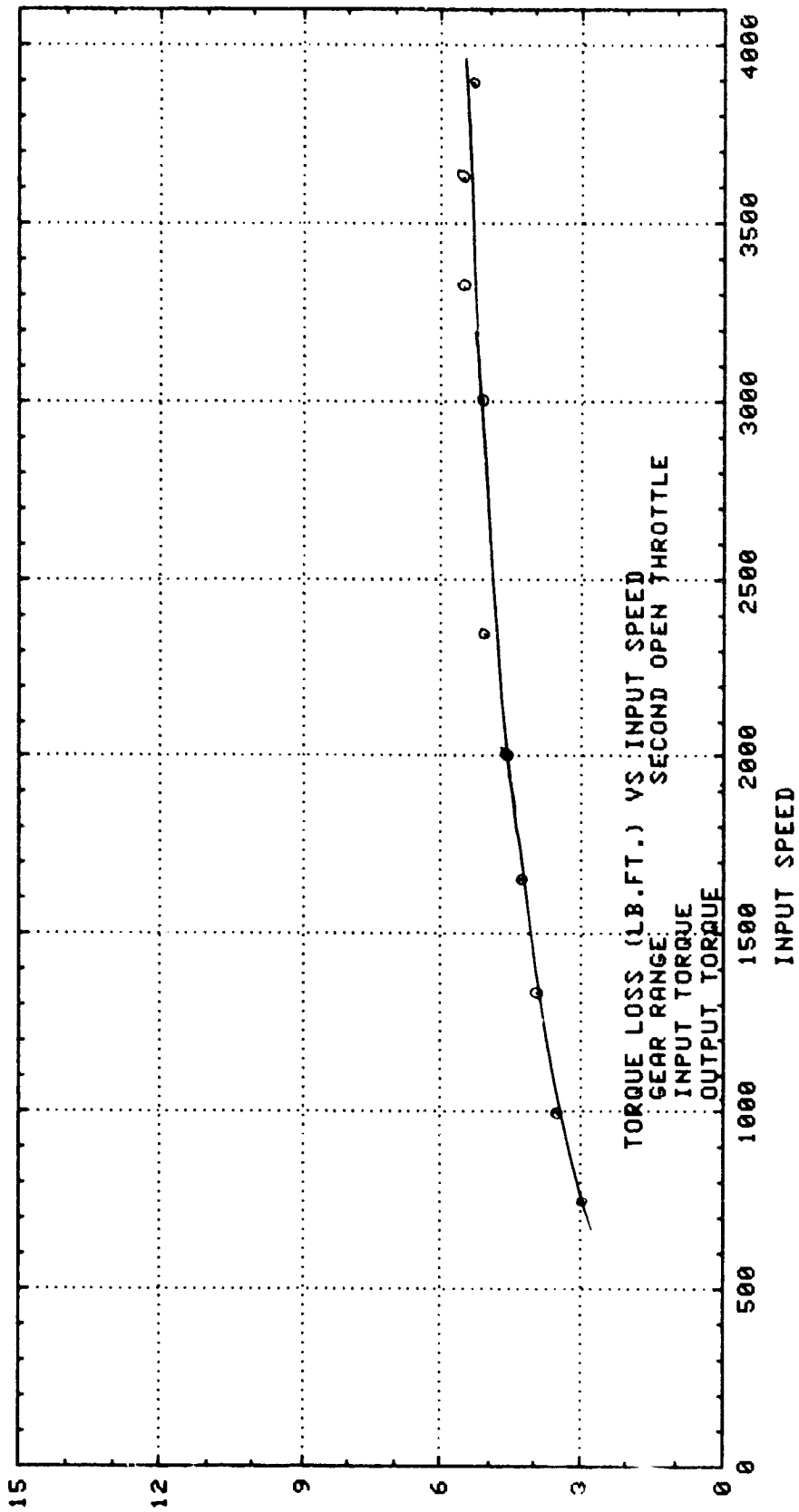



**NO LOAD LOSSES**  
**3rd Gear (Closed Throttle)**

TORQUE LOSS

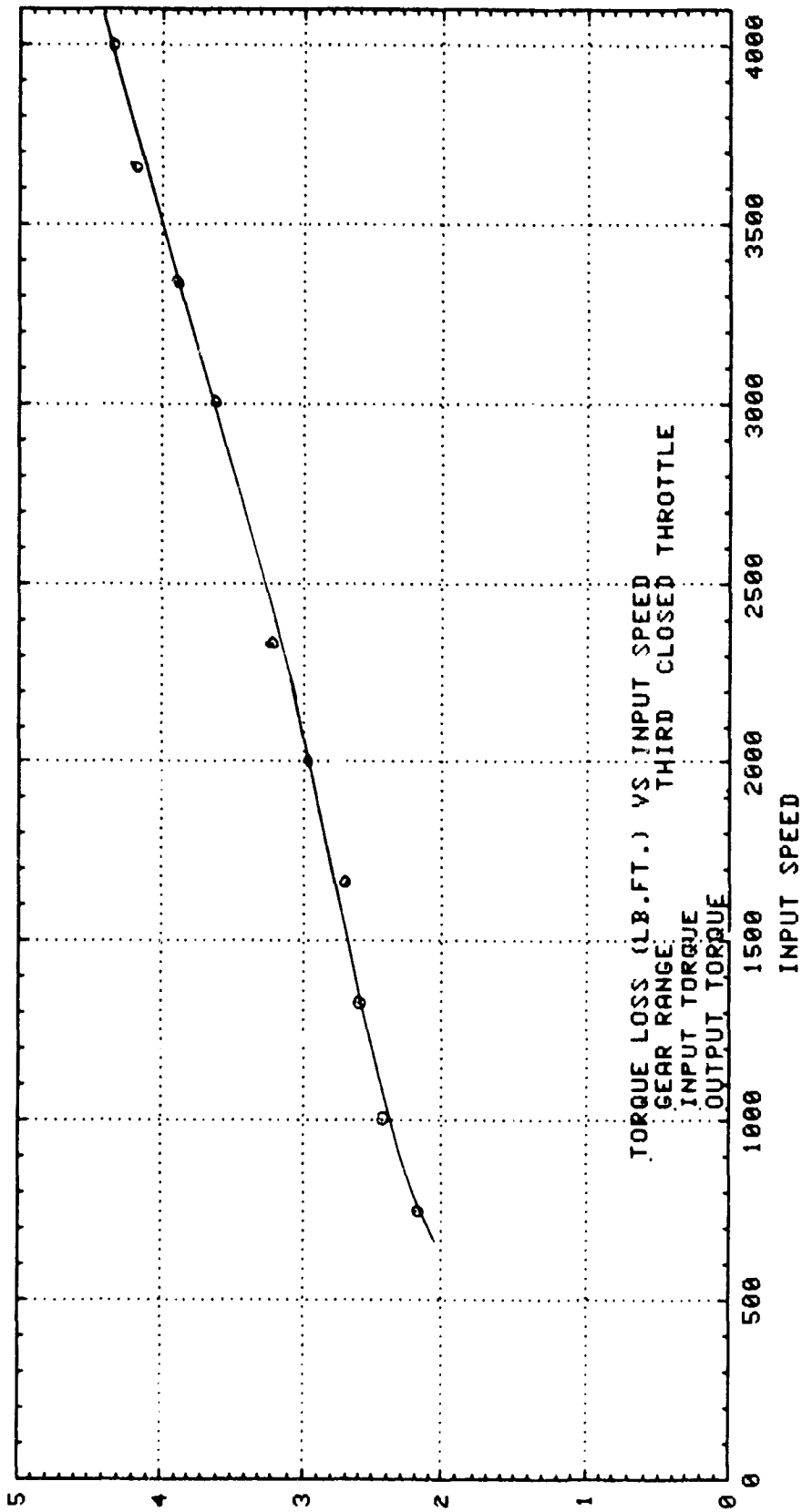

**NO LOAD LOSSES**  
**3rd Gear (Open Throttle)**

TORQUE LOSS

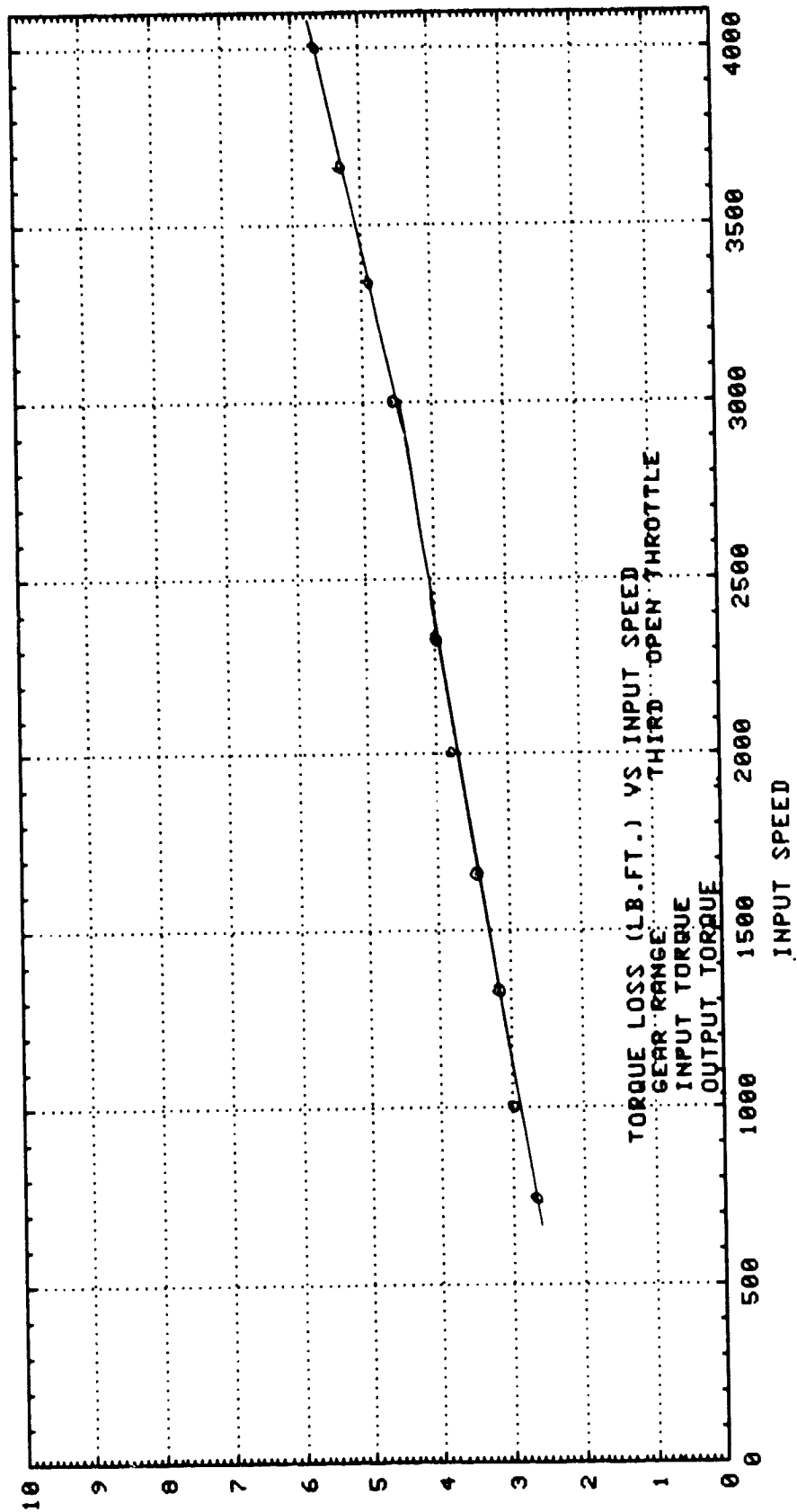

APPENDIX

ROOT MEAN SQUARE METHOD

$$\begin{aligned} \text{TORQUE ERROR (HIMMELSTEIN)} &= \sqrt{(\text{TORQUE TRANS. ERROR})^2 + (\text{TAPE RECORDER ERROR})^2 + (\text{ANALYSER ERROR})^2} \\ &= \sqrt{(0.21)^2 + (0.05)^2 + (0.048)^2} = \pm 0.221\% \text{ of Full Scale} \end{aligned}$$

$$\begin{aligned} \text{TORQUE ERROR (LEBOW)} &= \sqrt{(\text{TORQUE TRANS. ERROR})^2 + (\text{TAPE RECORDER ERROR})^2 + (\text{ANALYSER ERROR})^2} \\ &= \sqrt{(0.05)^2 + (0.05)^2 + (0.048)^2} = \pm 0.08\% \text{ of Full Scale} \end{aligned}$$

$$\begin{aligned} \text{SPEED ERROR} &= \sqrt{(\text{SPEED SENSOR})^2 + (\text{SPEED CONDITIONER})^2 + (\text{TAPE RECORDER ERROR})^2 + (\text{ANALYSER ERROR})^2} \\ &= \sqrt{(0.025)^2 + (0.10)^2 + (0.05)^2 + (0.048)^2} = \pm 0.124\% \text{ of Full Scale} \end{aligned}$$

$$\begin{aligned} \text{POWER OUT ERROR} &= \sqrt{(\text{TORQUE ERROR (LEBOW)} + \text{SPEED ERROR})^2 + (\text{COMPUTER CALCULATION ERROR})^2} \\ &= \sqrt{(0.08)^2 + (0.124)^2 + (0.5)^2} = \pm 0.5\% \text{ of Full Scale} \end{aligned}$$

$$\begin{aligned} \text{EFFICIENCY ERROR} &= \sqrt{(\text{TORQUE ERROR (LEBOW)})^2 + (\text{SPEED ERROR})^2 + (\text{TORQUE ERROR (HIMM)})^2 + (\text{SPEED ERROR})^2} \\ &\quad + (\text{COMPUTER CALCULATION ERROR})^2 \\ &= \sqrt{(0.08)^2 + (0.124)^2 + (0.221)^2 + (0.124)^2 + (0.5)^2} = \pm 0.579\% \text{ of Full Scale} \end{aligned}$$

SUM OF ERROR METHOD

$$\begin{aligned} \text{TORQUE ERROR HIMMELSTEIN} &= (\text{TORQUE TRANSDUCER ERROR}) + (\text{TAPE RECORDER ERROR}) + (\text{ANALYSER ERROR}) \\ &= (0.21) + (0.05) + (0.048) = \pm 0.308\% \text{ of Full Scale} \end{aligned}$$

$$\begin{aligned} \text{TORQUE ERROR (LEBOW)} &= (\text{TORQUE TRANS. ERROR}) + (\text{TAPE RECORDER ERROR}) + (\text{ANALYSER ERROR}) \\ &= (0.05) + (0.05) + (0.048) = \pm 0.148\% \text{ of Full Scale} \end{aligned}$$

$$\begin{aligned} \text{SPEED ERROR} &= (\text{SPEED SENSOR}) + (\text{SPEED CONDITIONER}) + (\text{TAPE RECORDER ERROR}) + (\text{ANALYSER ERROR}) \\ &= (0.025) + (0.1) + (0.05) + (0.048) = \pm 0.223\% \text{ of Full Scale (1 Volt = 4000 RPM)} \end{aligned}$$

$$\begin{aligned} \text{POWER OUT ERROR} &= (\text{TORQUE ERROR (LEBOW)} + (\text{SPEED ERROR}) + (\text{COMPUTER CALCULATION ERROR})) \\ &= (0.08) + (0.124) + (0.5) = \pm 0.704\% \text{ of Full Scale} \end{aligned}$$

$$\begin{aligned} \text{EFFICIENCY ERROR} &= (\text{TORQUE ERROR (LEBOW)}) + (\text{SPEED ERROR}) + (\text{TORQUE ERROR HIMM.}) + (\text{SPEED ERROR}) \\ &\quad + (\text{COMPUTER CALCULATION ERROR}) \\ &= (0.08) + (0.124) + (0.221) + (0.124) + (0.5) = \pm 0.1049\% \text{ of Full Scale} \end{aligned}$$

The inter number computer calculation error was determined by taking a set of sample calculations and comparing the accurate multiplication to the computer multiplication. A sample comparison is given below.

DATA DRIVE  
PERFORMANCE  
2ND GEAR

$T_i=40$  lb/ft                      ACCURATE CALCULATION    COMPUTER CALCULATION

$T_i=39.500$ ,  $T_o=116.3369$      $T_o/T_i=2.9452$                        $T_o/T_i=2.9367$

Comparison =  $(2.9452 - 2.9367)/2.9452 \times 100 = .288\%$

Since every calculation was not checked in this manner, a factor of safety was added to .288% and .5% was used as the inter number computer calculation error.

# HEWLETT PACKARD

## ANALYZER

### OTHER MANUALS

To locate specific manuals in the documentation shipped with the system, refer to the System Configuration Notice for the contents of each binder.

### SYSTEM SPECIFICATIONS & CHARACTERISTICS

The specifications in Table 1-1 describe the system's warranted performance. Those items under the heading of "Characteristics" go beyond the guaranteed specifications and give typical performance for some additional parameters and operations. These are included only to give you information which may be useful in applying the system.

Table 1-1. System Specifications and Characteristics

| <b>SPECIFICATIONS</b><br>(Specifications describe the standard system's warranted performance.)   |  |
|---|--|
| <b>ANALOG-TO-DIGITAL CONVERTER</b><br><b>Input Voltage Range:</b> $\pm 0.125V$ to $\pm 8V$ peak in steps of 2.<br><b>Input Coupling:</b> dc or ac.<br><b>Input Channels:</b> 2 channels wired for 4 standard. 4 channels optional with plug-in cards.<br><b>Resolution:</b> 12 bits including sign.<br><b>Input Frequency Range:</b> dc to 50 kHz, 5 Hz to 50 kHz, ac coupled (100 kHz optional).<br><b>Sample Rate:</b><br><b>Internal:</b> 100 kHz max. (1, 2, 3, or 4 channels simultaneously). (200 kHz optional on 1, 2, 3, or 4 channels.) (50 kHz max. (3 or 4 channels simultaneously).†)<br><b>External:</b> An external time base may be used to allow external control of the sampling rate up to 100 kHz (200 kHz optional). One sample can be taken for each clock pulse (TTL level).<br><b>Internal Clock Accuracy:</b> $\pm 0.01\%$ .          | <b>EXECUTION TIMES*</b><br><b>Fourier Transform:</b> <55 ms<br><b>Stable Power Spectrum Average:</b> <80 ms<br><b>Stable Tri-Spectrum Average:</b> <220 ms<br><br><b>REAL TIME BANDWIDTHS*</b><br><b>Fourier Transform:</b> >7.5 kHz<br><b>Stable Power Spectrum Average:</b> 5.4 kHz<br><b>Stable Tri-Spectrum Average:</b> 1.9 kHz   |
| <b>DISPLAY UNIT</b><br><b>Vertical Scale Calibration:</b> Data in memory is automatically scaled to give a maximum on-screen calibrated display. The scale factor is given in volts/division, volts <sup>2</sup> /division, or in dB offset.<br><b>Log Display Range:</b> 80 dB with a scale factor ranging from 0 to +998 dB. Offset selectable in 4 dB steps.<br><b>Linear Display Range:</b> $\pm 4$ divisions with scale factor ranging from $1 \times 10^{-512}$ to $5 \times 10^{512}$ in steps of 1, 2, and 5.<br><b>Digital UP/DOWN Scale:</b> Allows 8 up-scale and 2 down-scale steps (calibrated continuous scale factor).<br><b>Horizontal Scale Calibration:</b><br><b>Linear Sweep Length:</b> 10, 10.24 or 12.8 divisions.<br><b>Log Horizontal:</b> 0.5 decades/division.<br><b>Markers:</b> Intensity markers every 8th or every 32nd point. | <b>MASS STORAGE SOFTWARE</b><br><b>MAXIMUM REAL TIME DATA ACQUISITION RATE (Single Channel):</b><br><b>BS 256:</b> 10 kHz<br><b>BS 1024:</b> 39 kHz (25 kHz†)<br><b>BS 4096:</b> 80 kHz (30 kHz†)<br><br><b>OFF-LINE BSFA SOFTWARE</b><br><b>Center Frequency Range:</b> dc to one-half the Real Time Data Acquisition Rate.<br><b>Center Frequency Resolution:</b> Continuous resolution to the limit of the frequency accuracy for center frequencies >0.02% of the sampling frequency.<br><b>Frequency Accuracy:</b> $\pm 0.01\%$<br><b>Bandwidth Selection:</b> In steps of $f/5n$ where $n = 2, 3, 4$ , etc.<br><b>Max. Resolution Enhancement:</b> >400<br><b>Dynamic Range:**</b> 90 dB from peak out-of-band spectral component to the peak level of the passband noise.<br>80 dB from peak in-band spectral component to the peak level of the passband noise.<br><b>Out-of-Band Rejection:</b> >90 dB<br><b>Passband Flatness of the Digital Filter:</b> $\pm 0.01$ dB |
| <b>BASE SOFTWARE</b><br><b>Transform Accuracy:</b> The expected rms value of computational error introduced in either the forward or inverse FFT will not exceed 0.1% of the rms value of the transform result.<br><b>Dynamic Range:</b> >75 dB for a minimum detectable spectral component in the presence of one full scale spectral component after twenty ensemble averages for a block size of 1024.   | <b>ENVIRONMENTAL CONDITIONS</b><br><b>Temperature Range:</b> 0°C to 40°C (104°F).<br><br><small>*For band limited random noise type signals at block size 1024, no display, no Hanning.<br/>**After eight ensemble averages of a power spectrum at block size 1024. Reduced by 10 dB at the exact center of the band.<br/>†These rates apply to systems with modules 5466B and 54451A/B having a serial prefix lower than 1842.</small>  |



**e. FM RECORD/REPRODUCE SPECIFICATIONS**

Input Sensitivity: . . . . . 0.1 to 2.5 volts rms; adjustable with input attenuator for  $\pm 40\%$  deviation. Can be extended to 10 volts.

Nominal Input Level: . . . . .  $\pm 1.4$  volts peak.

Nominal Input Impedance: . . . . . 100 K ohms resistive, shunted by less than 100 pf, unbalanced to ground.

Frequency Response:

Flat Amplitude Filter . . . . . DC to 20 KHz, at 60 ips,  $\pm 0.5$  db;  $\pm 40\%$  deviation.

Linear Phase Filter . . . . . DC to 12 KHz, at 60 ips,  $\pm 0.5$  db;  $\pm 40\%$  deviation.

DC to 20 KHz at 60 ips,  $\pm 0.5$ , -3 db;  $\pm 40\%$  deviation.

Frequency Responses (Optional): . . . . . DC to 80 KHz at 120 ips using  $\pm 40\%$  deviation with IRIG intermediate band center frequency of 432 KHz. Upper frequency limit and center frequencies are proportionately lower at lower speeds, to 3-3/4 ips. DC to 10 KHz at 60 ips using  $\pm 40\%$  deviation with IRIG low band frequency of 54 KHz for improved S/N ratios. Upper frequency limit and center frequencies are proportionately lower at lower speeds.

DC Drift (Oscillator and Discriminator): . . . . . Less than  $\pm 0.5\%$  of peak-to-peak deviation per  $10^{\circ}$ F after 20 minute warm-up.

Signal/Noise Ratio . . . . . 40 db at 60 ips.

|   |   |
|---|---|
| DC Linearity: .....                           | Less than $\pm 0.5\%$ of peak-to-peak deviation reference to best straight line through zero. |
| AC Distortion: .....                          | Less than $1.5\%$ total harmonic distortion at all speeds.                                    |
| <b>Transient Response (60 ips):</b>           |   |
| Flat Amplitude Filter ( $\pm 1/2$ db) .....   | Rise Time (10% to 90% points) - 22 microseconds. Overshoot - less than 15%.                   |
| Linear Phase Filter ( $+1/2$ , -3 db) .....   | Rise Time (10% to 90% points) - 18 microseconds. Overshoot - less than 2.5%.                  |
| Output Level ( $\pm 40\%$ deviation): .....   | $\pm 1.4$ volts peak, into 1000 ohms, with short circuit protection (SCP).                    |
| Output Current ( $\pm 40\%$ deviation): ..... | $\pm 3$ milliamperes peak with SCP.   |
| Output Impedance: .....                       | Less than 50 ohms, unbalanced to ground, with SCP.  |

f. GENERAL

|                                |   |
|--------------------------------|---|
| Configuration: .....           | One standard 19 inch wide equipment enclosure for 14 channel FM or Direct Record/Reproduce System. For 28-32 vdc operation. Additional enclosure furnished for operation from other power supplies. Optional Rack Mounting Kit available. |
| Recorder Size (28-32 v): ..... | 26-1/8 inches high by 19 inches wide by 12 inches deep for a 7 channel-6 speed record/reproduce system or a 14 channel-6 speed record, 2 speed reproduce system. Additional enclosure (7-1/2 inches height) which attaches to portable    |

\_\_\_\_\_ 1-11 \_\_\_\_\_ ORIGINAL 

# Rotating Shaft Torque Sensors

LEBOW  
ROTARY TRANSFORMER



**Model 1602**  
Low capacity torque sensors.

| Capacity (Oz. In.) | Max. Speed (RPM) | Model   | Protected for Overloads to (Oz. In.) | Torsional Stiffness (Lb. In./Rad.) | Rotating Inertia (Lb.-In. <sup>2</sup> ) | Weight (Lbs.) |
|--------------------|------------------|---------|--------------------------------------|------------------------------------|--|---------------|
| 50                 | 20,000           | 1602-50 | 150                                  | 400                                | .35                                      | 3¼            |
| 100                | 20,000           | -100    | 300                                  | 1,000                              | .35                                      | 3¼            |
| 200                | 20,000           | -200    | 600                                  | 2,500                              | .35                                      | 3¼            |
| 500                | 20,000           | -500    | 1,500                                | 5,500                              | .35                                      | 3¼            |
| 1,000              | 20,000           | -1K     | 1,500                                | 8,000                              | .35                                      | 3¼            |

**Models 1604, 1605 & 1607**  
Utility rotating shaft torque sensor recommended for general application.

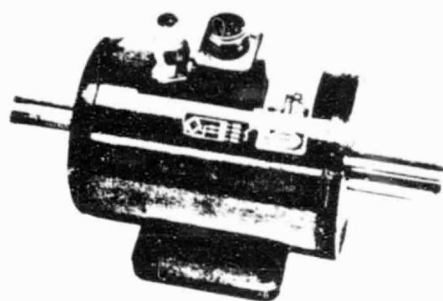

| Capacity (Lb. In.) | Max. Speed (RPM) | Model    | Protected for Overloads to (Lb. In.) | Torsional Stiffness (Lb. In./Rad.) | Rotating Inertia (Lb.-In. <sup>2</sup> ) | Weight (Lbs.) |
|--------------------|------------------|----------|--------------------------------------|------------------------------------|--|---------------|
| 50                 | 15,000           | 1604-50  | 150                                  | 5,000                              | 1.0                                      | 18            |
| 100                | 15,000           | -100     | 300                                  | 13,500                             | 1.0                                      | 18            |
| 200                | 15,000           | -200     | 600                                  | 33,000                             | 1.0                                      | 18            |
| 500                | 15,000           | -500     | 1,500                                | 85,000                             | 1.0                                      | 18            |
| 1,000              | 15,000           | -1K      | 3,000                                | 150,000                            | 1.0                                      | 18            |
| 2,000              | 15,000           | -2K      | 6,000                                | 225,000                            | 1.0                                      | 18            |
| 2,000              | 15,000           | 1605-2K  | 6,000                                | 700,000                            | 3.25                                     | 28            |
| 5,000              | 15,000           | -5K      | 15,000                               | 950,000                            | 3.25                                     | 28            |
| 10,000             | 15,000           | -10K     | 20,000                               | 1,000,000                          | 3.25                                     | 28            |
| 20,000             | 4,000            | 1607-20K | 60,000                               | 6,800,000                          | 52.0                                     | 75            |
| 50,000             | 4,000            | -50K     | 150,000                              | 11,800,000                         | 57.0                                     | 75            |
| 100,000            | 4,000            | -100K    | 150,000                              | 19,950,000                         | 180.0                                    | 75            |

**Model 1615**  
Standard-flange housing mount with AND pads to match Army-Navy mountings standard.

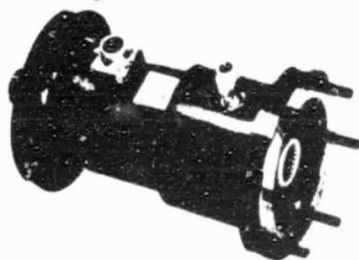

| Capacity (Lb. In.) | Max. Speed (RPM) | Model    | Protected for Overloads to (Lb. In.) | Torsional Stiffness (Lb. In./Rad.) | Rotating Inertia (Lb.-In. <sup>2</sup> ) | Weight (Lbs.) |
|--------------------|------------------|----------|--------------------------------------|------------------------------------|--|---------------|
| 50                 | 15,000           | 1615A-50 | 150                                  | 1,500                              | 1.0                                      | 24            |
| 100                | 15,000           | -100     | 300                                  | 4,000                              | 1.1                                      | 24            |
| 200                | 15,000           | -200     | 600                                  | 10,000                             | 1.2                                      | 24            |
| 500                | 15,000           | -500     | 1,500                                | 20,000                             | 1.3                                      | 24            |
| 1K                 | 15,000           | -1K      | 1,500                                | 25,000                             | 1.4                                      | 24            |
| 50                 | 15,000           | 1615K-50 | 75                                   | 1,620                              | 1.04                                     | 25            |
| 100                | 15,000           | -100     | 150                                  | 4,570                              | 1.05                                     | 25            |
| 200                | 15,000           | -200     | 300                                  | 12,900                             | 1.06                                     | 25            |
| 500                | 15,000           | -500     | 750                                  | 940,000                            | 1.97                                     | 25            |
| 1,000              | 15,000           | -1K      | 1,500                                | 204,000                            | 2.00                                     | 25            |
| 2,000              | 15,000           | -2K      | 3,000                                | 347,000                            | 2.08                                     | 26            |
| 5,000              | 15,000           | -5K      | 7,500                                | 500,000                            | 2.38                                     | 26            |
| 10,000             | 15,000           | -10K     | 15,000                               | 574,000                            | 2.76                                     | 26            |

**Model 1648**  
Flange drive units recommended for use when short length is mandatory.



| Capacity (Lb. In.) | Max. Speed (RPM) | Model   | Protected for Overloads to (Lb. In.) | Torsional Stiffness (Lb. In./Rad.) | Rotating Inertia (Lb.-In. <sup>2</sup> ) | Weight (Lbs.) |
|--------------------|------------------|---------|--------------------------------------|------------------------------------|--|---------------|
| 2,000              | 5,000            | 1648-2K | 3,000                                | 742,000                            | 23.0                                     | 23            |
| 5,000              | 5,000            | -5K     | 7,500                                | 1,811,000                          | 23.0                                     | 23            |
| 10,000             | 5,000            | -10K    | 15,000                               | 2,248,000                          | 23.0                                     | 23            |
| 20,000             | 5,000            | -20K    | 30,000                               | 3,507,000                          | 23.5                                     | 23            |

## GENERAL SPECIFICATIONS: (All Models)

SENSOR: Four arm bonded foil strain gage bridge  
BRIDGE RESISTANCE: 350 ohms nominal  
BRIDGE VOLTAGE: 20 volts maximum, 3 KHz  
OUTPUT: 2 to 2.5 millivolt/volt nominal

→ LINEARITY: 0.1% of full scale

COMPENSATED TEMPERATURE RANGE: 30°F to 150°F  
USEABLE TEMPERATURE RANGE: 0°F to 200°F  
EFFECT OF TEMPERATURE ON ZERO: .002% of full scale/°F  
EFFECT OF TEMPERATURE ON OUTPUT: .002% of reading/°F

# MCRT® 6-02T Non-Contact Torquemeter

MAX. TORQUE—15,000 lb.-in.  
SPEED — 0 - 7,500 rpm

## GENERAL DESCRIPTION

The MCRT® 6-02T is a compact, high accuracy, flanged torquemeter well adapted for vehicle drive-line measurements and continuous monitoring and feedback applications. It uses a rotating strain gage torque bridge, temperature compensated for drift and modulus. The bridge is connected to a stationary electronic readout via integral, non-contact rotary transformers.

The torquemeter is immune to water, lubricants, coolants, vibration, etc. The elimination of slip-rings permits high accuracy low level measurements with long, maintenance-free life. Thrust and bending loads are inherently cancelled by the transducer design. An optional, integral non-contact speed pickup may be specified when ordering.

*Linearity:* 0.1%

*Temperature Effects:* From 75 to 175° F maximum drift is 0.2% of full scale and maximum error due to modulus change is 0.2% of reading.

*Maximum Operating Temperature:* 220° F, assuming permanent lubrication. Above 175° F, the maximum shaft speed may have to be de-rated.

*Readout:* Any carrier amplifier suitable for strain gage service may be used.

*Excitation Voltage:* 10 volts rms, maximum.

*Nominal Output:* 0.75 millivolts/volt (open circuit).

*Standard Ratings:*

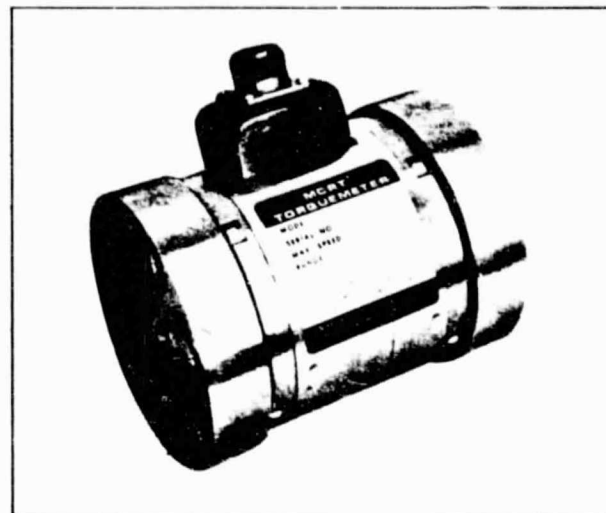

| MODEL       | FULL SCALE TORQUE<br>(lb. - in.) | TORSIONAL STIFFNESS<br>(lb. - in./rad.) | MAXIMUM BENDING MOMENT<br>(lb. - in.) | MAXIMUM ROTATING INERTIA<br>(in. - oz. sec. <sup>2</sup> ) | MAXIMUM WEIGHT<br>(lbs.) |
|-------------|----------------------------------|---|---------------------------------------|--|--------------------------|
| MCRT® 6-02T |                                  |   |                                       |  |                          |
| -(1-3)      | 1,000                            | 602,000                                 | 500                                   | 0.60   | 13.8                     |
| -(2-3)      | 2,000                            | 1,375,000                               | 1,000                                 | 0.60   | 13.8                     |
| -(4-3)      | 4,000                            | 2,640,000                               | 2,000                                 | 0.60   | 13.8                     |
| -(6-3)      | 6,000                            | 2,430,000                               | 3,000                                 | 0.90   | 17.0                     |
| -(10-3)     | 10,000                           | 2,930,000                               | 5,000                                 | 0.90   | 17.0                     |
| -(15-3)     | 15,000                           | 3,530,000                               | 5,500                                 | 0.90   | 17.0                     |

*Overload Capacity:* 2 times full scale rating.

*Shaft Speed:* 0 to 7,500 rpm, bi-directional. Optional speed pickup produces 60 pulses per shaft revolution.

*Construction:* Load carrying members (flanges, shaft) are 17-4 PH high strength stainless steel.

### NOTES:

[1] Maximum speed rating assumes permanent lubrication. Consult factory for higher speed operation.

[2] When combined axial and bending loads are present, the bending capacity must be de-rated. Consult factory.

[3] Stator should be compliantly restrained from rotating.

## S. HIMMELSTEIN AND COMPANY

2500 ESTES AVENUE, ELK GROVE VILLAGE, ILLINOIS 60007 • TELEPHONE: (312) 439-8181

A-8

100/5-75 Patented

Copyright 1969 - Printed in U.S.A.

843-7700



DAYTRONICS

MODEL  
**840**

## FREQUENCY-TO-VOLTAGE CONVERTER

The Model 840 Frequency-to-Voltage Converter is a conditioner-amplifier module that accepts input signals in a wide range of frequencies, wave shapes, and voltage levels and produces standard system output voltages precisely proportional to the frequency or repetition rate of the input signal. It is intended for use in "800" systems for measurement of **flow, rpm, and** similar phenomena that can be derived from magnetic pickups, turbine flowmeters, or other frequency-producing sources.

Nine selectable frequency ranges accommodate virtually all mechanical measurement requirements. An internal crystal oscillator reference and adjustable output span allow precise calibration of the indicating device in terms of *frequency, rpm, or any other chosen units* appropriate to the particular measurement. In flow measurement, for example, the Model 840 can be used with the Model 890 Digital Indicator and calibrated, using the front panel controls, so as to indicate directly in *gallons per minute or gallons per hour*, provided only that the flowmeter **K Factor (cycles per gallon)** is known.\*

The Model 840 is also used in conjunction with the Model 862 Multiplier Module in an instrument that can display *torque, rpm, and shaft horsepower* in digital engineering units. Additional information on this and other instrument combinations is contained under the Model 862 description.

\*If fluid specific gravity is also known, calibration can be made in units of *mass flow*, such as Pounds per Hour. For applications where specific gravity is subject to change, corrections can be entered manually on a calibrated dial (see Model 868, p 46) or applied automatically by a temperature sensing channel (see Model 862, page 42).

### SPECIFICATIONS

#### Input:

Type: . . . . . any AC signal, grounded or floating, irrespective of waveform.  
 Sensitivity: . . . Three ranges (Lo, Med, & Hi), plus vernier, allow adjustment of threshold level from 5 mv to 50 volts (peak). Maximum continuous input voltage is 25 v, 100 v, & 250 v (RMS), respectively. Input is undamaged by momentary peak voltage of 500 volts on any range. Differential input impedance is 20K ohms, 400K ohms, and 8 Megohms, respectively.  
 Common mode rejection: . . . greater than 60 dB to 2 kHz and greater than 30 dB to 100 kHz.  
 Frequency ranges: . . . . . 100 Hz, 200 Hz, and 500 Hz, with multipliers of X1, X10, and X100; each with 100% overrange.

#### Output:

Standard One Volt Data Signal: . . . . . (see Table One, page 7).  
 Standard Ten Volt Output Signal: . . . . . (see Table One, page 7).  
 Step function response (to 99% of final value): . . . . . 800 ms for X1 multiplier, 80 ms for X10 and X100 multipliers.  
 Step function response (to 99.9% of final value): . . . . . 2.5 sec for X1 multiplier, 250 ms for X10 and X100 multipliers.  
 Ripple and noise (max.): . . . . . less than 0.2% of full scale from 10% to 100% of scale.  
 Accuracy: . . . . . 0.05% of scale (based on average value of DC output).  
 Housing: . . . . . standard full-width module.  
 Operating temperature range: . . . . . +50 to +120 degrees F.  
 Power requirements: . . . . . 105-130 volts, 50-400 Hz.

PRICE: Model 840 Frequency-to-Voltage Converter . . . . . **\$495.00**