

Toshiba's transportation system technology is widely-used all over the world.

TOSHIBA

Railway Power Supply Systems

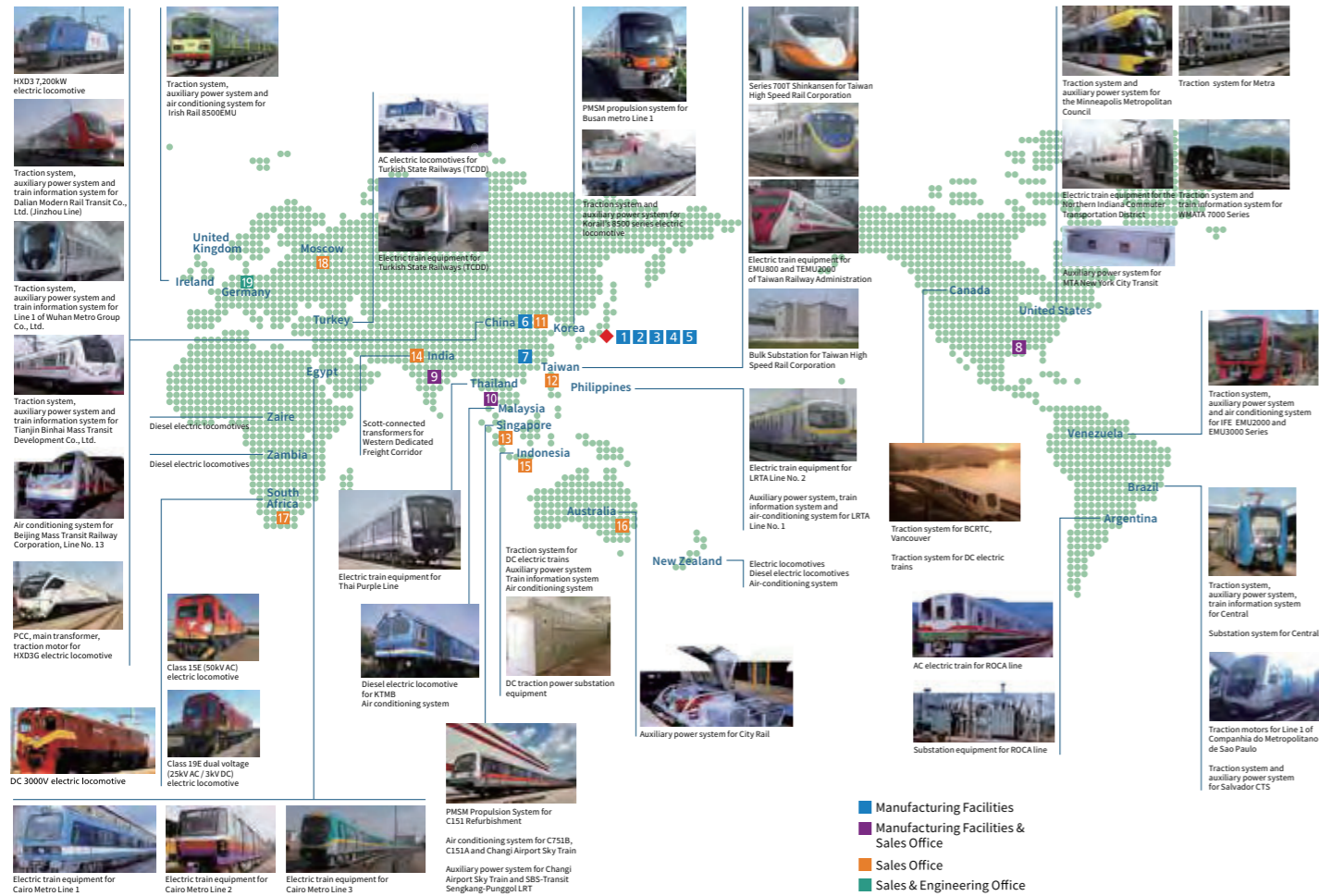

Headquarters

- ◆ Headquarters (Kawasaki, Japan)

Manufacturing Facilities

- 1 Fuchu Complex (Tokyo, Japan)**
Electric locomotives, traction control equipment, auxiliary power supply equipment, traction motor, train information system, ATC/ATS system, etc.
- 2 Mie Operations (Mie, Japan)**
Transformers, motor control centers
- 3 Hamakawasaki Operations (Kawasaki, Japan)**
Transformers, switchgears, surge arresters
- 4 Kashiwazaki Operations (Kashiwazaki, Japan)**
Rechargeable Battery
- 5 Toshiba Carrier Corporation (Fuji, Japan)**
Air-conditioning systems
- 6 Dalian Toshiba Locomotive Equipment Co., Ltd. (Dalian, China)**
Drive systems for locomotives, DC train drive systems, auxiliary power supply, traction motor, train information system, etc.
- 7 Guangzhou Toshiba Baiyun Electrical Equipment Co., Ltd. (Guangzhou, China)**
MV Switchgears

Manufacturing Facilities & Sales Office

- 8 Toshiba International Corporation (Houston, U.S.A.)**
Motors, adjustable speed drives (inverters), UPSs, switchgears, transportation systems, etc.
- 9 Toshiba Transmission & Distribution Systems (India) Pvt. Ltd. (Telangana, India)**
Converter/inverter system, Auxiliary converters, Train control and monitoring system, Control electronics
- 10 Toshiba Transmission & Distribution Systems Asia Sdn. Bhd. (Petaling Jaya, Malaysia)**
MV Switchgears, EPC of Substations

Sales Office

- 11 Toshiba China Co., Ltd. (Dalian, China)**
- 12 Toshiba Electronic Components Taiwan Corporation (Taipei, Taiwan)**
- 13 Toshiba Asia Pacific Pte Ltd (Singapore)**
- 14 Toshiba India Private Ltd. (Gurgaon, India)**
- 15 PT. Toshiba Asia Pacific Indonesia (Jakarta, Indonesia)**
- 16 Toshiba International Corporation Pty Ltd (Sydney, Australia)**
- 17 Toshiba Africa (Pty) Ltd. (Sandton, South Africa)**
- 18 Toshiba Rus LLC (Moscow, Russia)**

Sales & Engineering Office

- 19 Toshiba Railway Europe GmbH (Kiel/Düsseldorf, Germany)**
Hybrid Locomotive

Find out more about Toshiba transportation solutions on <http://toshiba-railway.com>

Toshiba Infrastructure Systems & Solutions Corporation

72-34, Horikawa-cho, Saiwai-ku, Kawasaki-shi, Kanagawa 212-8585, Japan

Railway Systems Division TEL.+81-(0)44-576-6737

- The information contained herein is as of August 1, 2018.
- The information contained herein is subject to change without notice.
- The information contained herein is presented only as a guide for the applications of our products. No responsibility is assumed by TOSHIBA for any infringements of patents or other rights of the third parties which may result from its use. No license is granted by implication or otherwise under any patent or patent rights of TOSHIBA or others.
- TOSHIBA products should not be embedded to the downstream products which are prohibited to be produced and sold, under any law and regulations.
- TOSHIBA does not take any responsibility for incidental damage (including loss of business profit, business interruption, loss of business information, and other pecuniary damage) arising out of the use or disability to use TOSHIBA products.
- The products described in this document may include products subject to the foreign exchange and foreign trade laws.
- The products described in this document may contain components made in the United States and subject to export control of the U.S. authorities. Diversion contrary to the U.S. law is prohibited.



Railway Power Supply Systems

Rail transport has been evaluated as an environment-friendly transportation system, helping to solve environmental pollution, energy resources shortage, and chronic traffic congestion problems in developing countries. Since Toshiba started manufacturing traction motor and propulsion systems in 1899, we have made continuous technological innovations which led to the creation of new transportation systems, including power supply systems. We have now expanded our business to supply advanced technologies on a global scale. In the pursuit of technological innovation, global environmental issues are important, and demand is high for the creation of a new product value aimed at reducing environmental impact while ensuring safety and comfort. We offer products and systems to support your organization's activities aimed at protecting the environment, thus contributing to the creation of a sustainable, eco-friendly society.

AC Electrification Systems

- Traction Transformer
- Auto-transformer
- Feeding Circuit Breaker
- Feeding Switchgear (GIS, C-GIS, SIS)
- Changeover Switch
- Control / Relay Panel
- AC Feeding Protection Relay

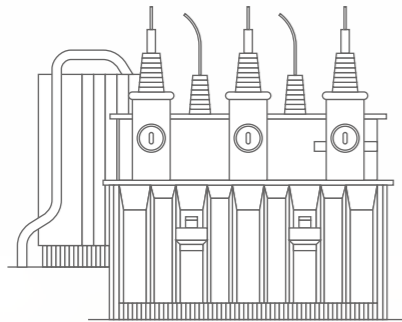

Transmission Systems

- Gas Insulated Switchgear (GIS)
- Gas Insulated Transformer (GIT)
- Gas Circuit Breaker (GCB)
- Cubicle Type Gas Insulated Switchgear (C-GIS)
- Solid Insulated Switchgear (SIS)

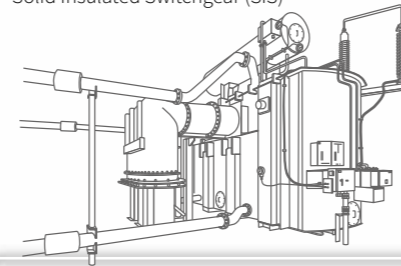

DC Electrification Systems

- Rectifier Transformer
- Traction Rectifier
- Regenerative Inverter
- DC Switchgear
- Protection Relay
- HSVCB
- Package-Type DC Substation
- Traction Energy Storage System (TESS) with SCiB™

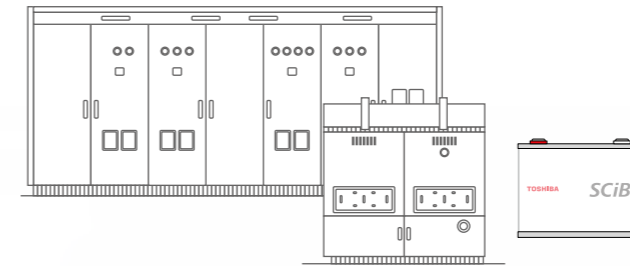

Control Center

- Supervisory Control And Data Acquisition (SCADA)

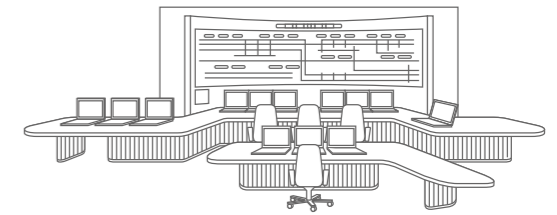

System Integration

Toshiba has been continuously striving to provide customers with advanced, optimal solutions. We are able to provide not only the latest environmentally-friendly products from all over the world but also consulting services like energy simulation and construction works as well.

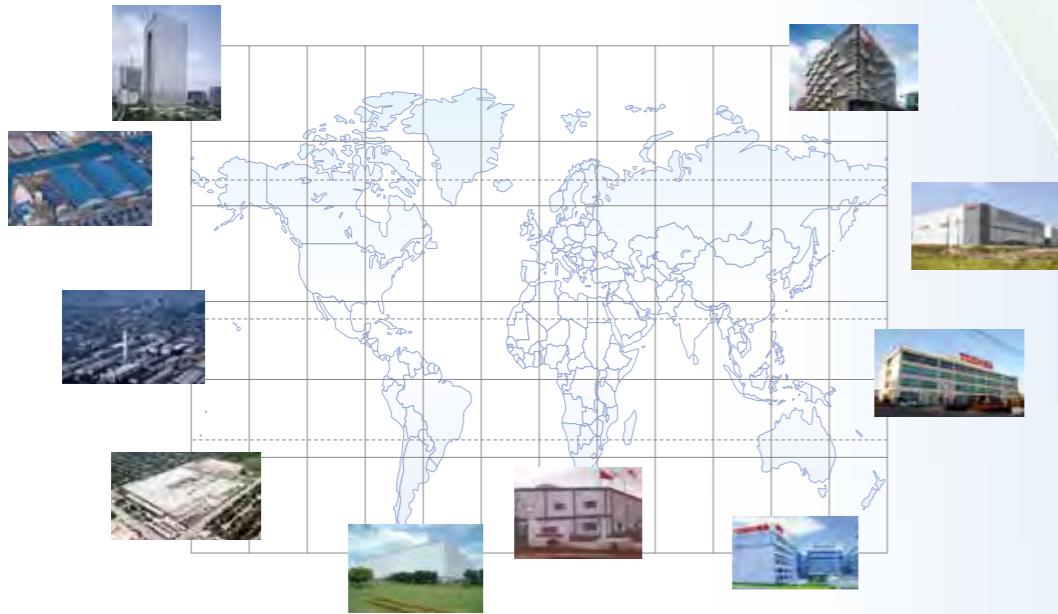

Toshiba is able to supply transmission and distribution products from our bases all over the world, using our worldwide distributors to offer customer-oriented solutions at a competitive price.

Procurement & Manufacturing



Solid Insulated Switchgear



Vegetable Oil Transformer



Traction Energy Storage System (TESS) with SCiB™

Engineering

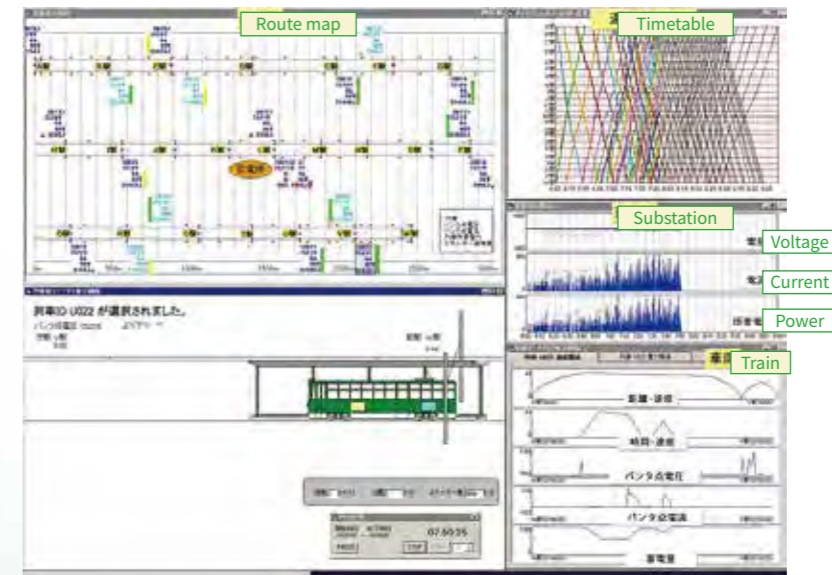

Example of Power Supply Simulation

Our long history of engineering railway system projects has given us extensive expertise in designing railway power supply systems. Our in-house simulator is able to calculate various railway system conditions with remarkable accuracy. Our experienced engineers are also there to provide consultation and offer customer-oriented solutions.



Construction



Taiwan High Speed Railway Project

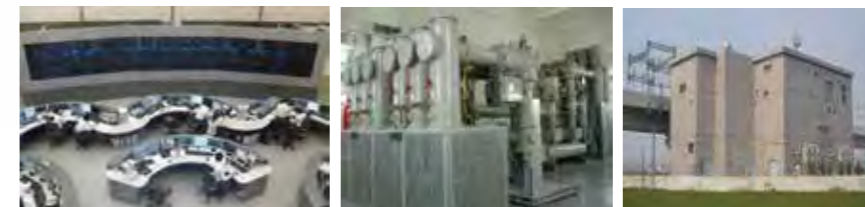

Having started in the transportation business in 1899, Toshiba has extensive experience in offering innovative railway system products. For power supply systems, our current products such as the Solid Insulated Switchgear, Vegetable Oil Transformer and Traction Energy Storage System (TESS) with SCiB™, are environment friendly solutions which contribute to a more sustainable environment.

In addition to supplying products, Toshiba also provides customers with FTK solutions. One representative example of our FTK, the Taiwan High Speed Railway, wherein Toshiba built and supplied essential products for railway electrification.

Transmission Systems

Railway Power Supply equipment must be highly reliable and safe. In addition, today's equipment must also be economically efficient to accommodate installation in limited space and in a short period of time. Therefore, Toshiba developed the highly reliable SF₆ Gas Insulated Switchgear (GIS) which can simplify site work and reduce land footprint by up to 92%.



Transmission Systems

For the main transformer, Toshiba offers a non-flammable Gas Insulated Transformer (GIT) for a more compact substation solution. As for Toshiba's product line-up for middle voltage switchgears, we developed the Cubicle type Gas Insulated Switchgear (C-GIS) and SF₆ gas free Solid Insulated Switchgear (SIS).

Typical space for AIS+OIT
2,236m²

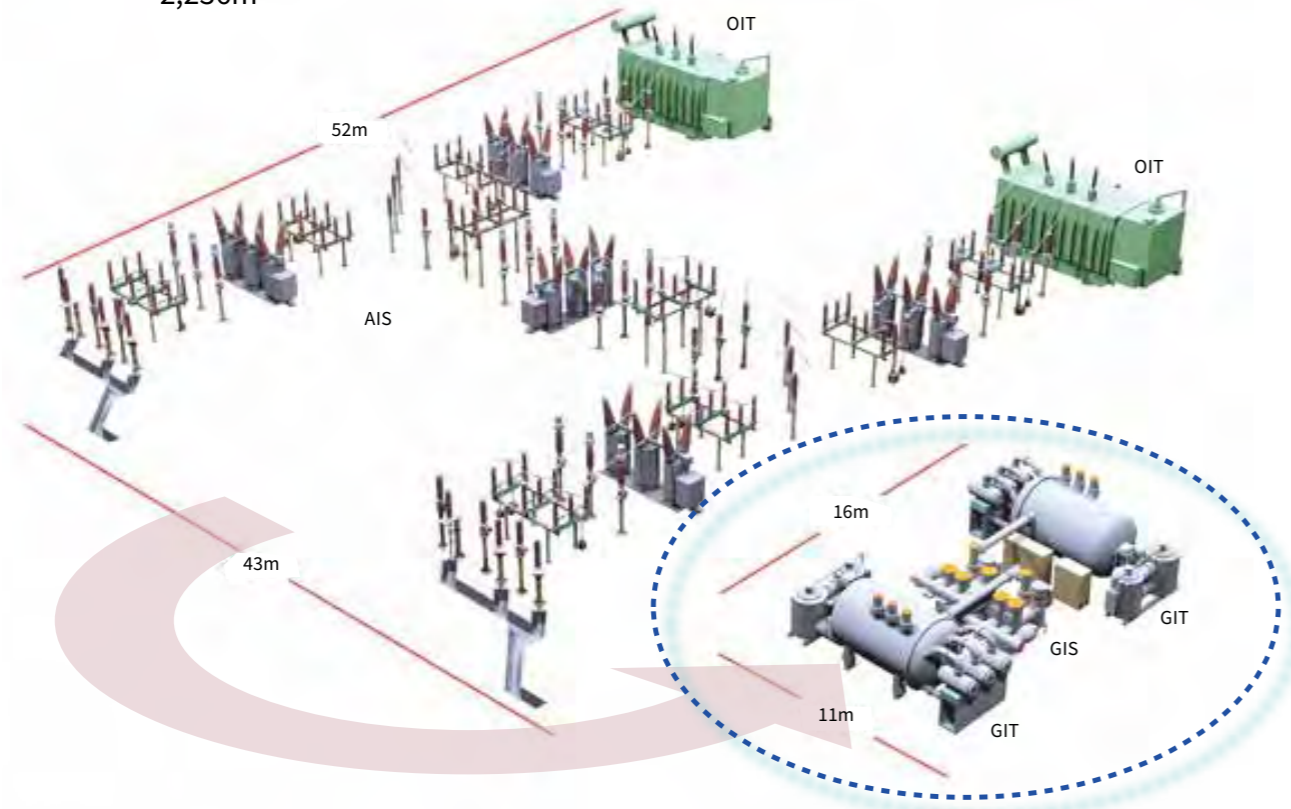

A compact solution with GIS and GIT

AIS : Air Insulated Switchgear
OIT : Oil Insulated Transformer
GIS : Gas Insulated Switchgear
GIT : Gas Insulated Transformer

Our GIS+GIT - Sample Layout
176m² (8% of AIS + OIT land footprint)

Gas Insulated Switchgear (GIS)

The Gas Insulated Switchgear (GIS) is an integrated switchgear which uses SF₆ insulation gas. It is used mainly in 72.5kV or higher systems. Toshiba has a long history for developing and manufacturing GIS.

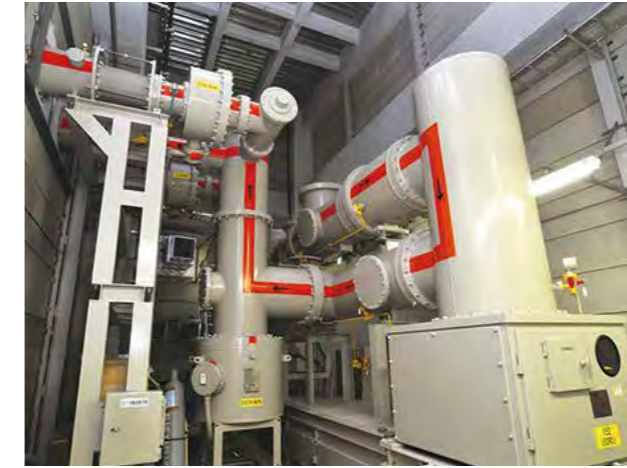

168kV GIS



170kV GIS

Ratings

Rated Voltage [kV]	72.5 ~ 252
Rated Interrupting Current [kA]	25 ~ 63
Rated Lightning Impulse Withstand Voltage [kV]	325 ~ 1050
Rated Power Frequency Withstand Voltage [kV]	140 ~ 460
Applicable Standards	JEC / IEC

Features

- **Compact Design**
Can be installed in indoor and underground substations
- **Outdoor Compatibility**
Protection against pollution
- **Safe Operation**
Electrified parts are enclosed in the earthed tank
- **Low Maintenance**

Gas Insulated Transformer (GIT)

The Gas Insulated Transformer (GIT) uses SF₆ gas for insulation and cooling instead of mineral oil and is suitable for indoor and underground substations. GIT development and manufacturing at Toshiba also has a long history.



GIT

Features

- **Non-flammability**
SF₆ gas is used instead of mineral oil, alleviating the need for a fire fighting system. This also allows the installation in the same room with the GIS for a more compact substation layout.
- **Non-explosive**
No pressure relief device is needed.
- **Compact Design**
Conservator and pressure relief device are not required thus lowering the height to less than that of OITs.

3-3

Gas Circuit Breaker (GCB)

Toshiba supplies many types of Gas Circuit Breakers (GCB) for 72kV or higher voltage.



240kV GCB



72kV GCB

Ratings

	GSR	GSM / GSP
Rated Voltage [kV]	240 / 300	72 / 84 / 168
Method of Operation	Hydraulic	Motor Spring
Tank	Dead Tank	
Rated Withstand Voltage	Lighting Impulse [kV]	900 / 1050
	Power Frequency [kV]	200-265-200(1min)/250-330-250(1min)
		350 / 400 / 750
		140 / 160 / 325
Applicable Standards	JEC / IEC	

- Features**
- Easy Installation
 - Low Noise

3-4

Cubicle Type Gas Insulated Switchgear (C-GIS)

The Cubicle Type Gas Insulated Switchgear (C-GIS) is an integrated switchgear which uses SF₆ insulation gas. It is used mainly in 36kV to 84kV systems. Toshiba spent many years developing and manufacturing high quality C-GIS. Vacuum circuit breakers (VCB) are used for the C-GIS.



72kV C-GIS

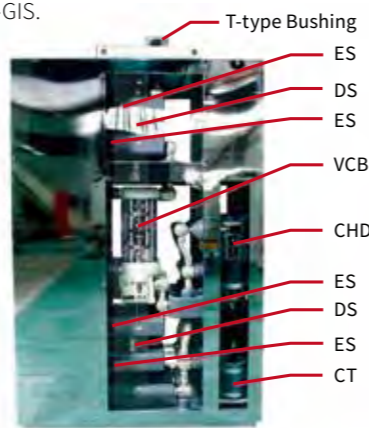

Cross-section

Ratings

	36	40.5	72	84
Rated Voltage [kV]	36	40.5	72	84
Rated Withstand Voltage	Lightning Impulse [kV]	170	185	350
	Power Frequency [kV]	70	95	140
		630 / 1250 / 2500	630 / 1250 / 2000	800 / 1250
Rated Current [A]				
Rated Short Time Withstand Current [kA]		25 / 31.5	20 / 25 / 31.5	20 / 25 / 31.5
Applicable Standards	JEC / IEC			

- Features**
- Compact Design
 - Outdoor Compatibility
 - Safe Operation
 - Low Maintenance
 - Easy Cable Withstand Voltage Test

3-5

Solid Insulated Switchgear (SIS)

Solid Insulated Switchgear (SIS) utilizes high-performance epoxy resin independently developed as the insulating material for SIS. This epoxy resin provides remarkable improvement in strength, flexibility, heat-resistance and dielectric strength. With the use of this material for switchgear insulation, size was reduced while maintaining the equipment's high reliability. Installation space required for SIS is smaller than our conventional air-insulated switchgear. For the 24/36kV SIS, Balanced Magnetic Acuator (BMA) for the VCB is utilized which further reduces the size and weight of the SIS without compromising its performance.



24kV SIS

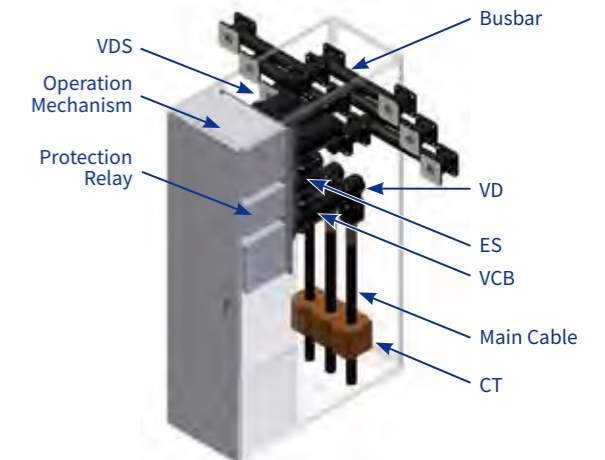

Ratings

Rated Voltage [kV]	24	36	40.5	72	84
Rated Withstand Voltage	Lightning Impulse [kV]	125	170	185	350
	Power Frequency [kV]	50	70	95	140
		630 / 1250 / 2000	1250 / 2000	800 / 1250	
Rated Current [A]					
Rated Short Time Withstand Current [kA]				25 / 31.5	
Applicable Standard	JEC / IEC / GB				

- Features**
- SF₆ gas-less due to epoxy-resin coating
 - Compact Design
 - Outdoor Compatibility
 - Safe Operation
 - Low Maintenance
 - High Reliability

Eco-Friendly Design

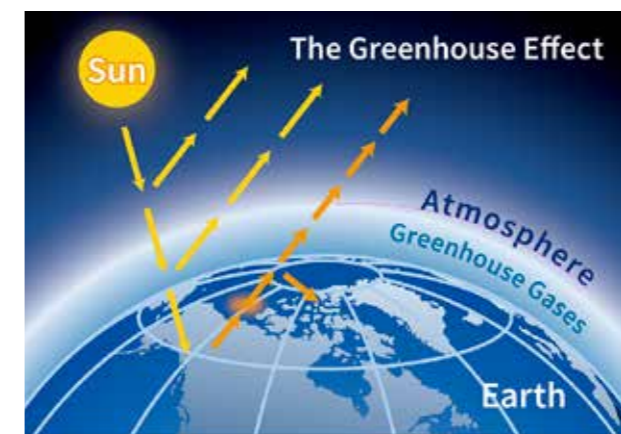

SF₆ gas is evaluated as the most potent greenhouse gas and it poses negative effects in the environment. As part of Toshiba's drive for the development of more eco-friendly products, Toshiba introduced a new material which possesses high dielectric strength.

Safe Design



SIS Busbar Compartment

SIS has an "Internal arc-free" feature which promotes safe operation. Busbar and devices in each phase of the main circuit are completely insulated with earthed layer of Toshiba's unique epoxy resin mold coating.

AC Electrification Systems

Toshiba provides a highly-reliable and modernized AC electrification system which consists of elements such as large capacity of traction transformers, single phase circuit breakers, surge arrestors, and changeover switches. Our products are designed with the advance technology based on our long history of development. It contributes to a safe, stable and cost-minimized system operation for a long term.

Features

- Toshiba can supply various types of transformers and propose the most suitable type of transformer according to customer specification such as voltage, capacity, loss, installation condition, etc.
- The changeover switches are used for the phase break point of high speed railway system. Our product is designed for long time operation under the harsh conditions of high voltages and repeating surges.
- The control and relay panels supplied by Toshiba are designed with the advance digital technologies. They integrate all required functions such as protection, control and monitoring by the intelligent digital relays, PLCs and the LAN connection network.

TOSHIBA'S POWER SUPPLY SYSTEMS for AC Feeding Substation

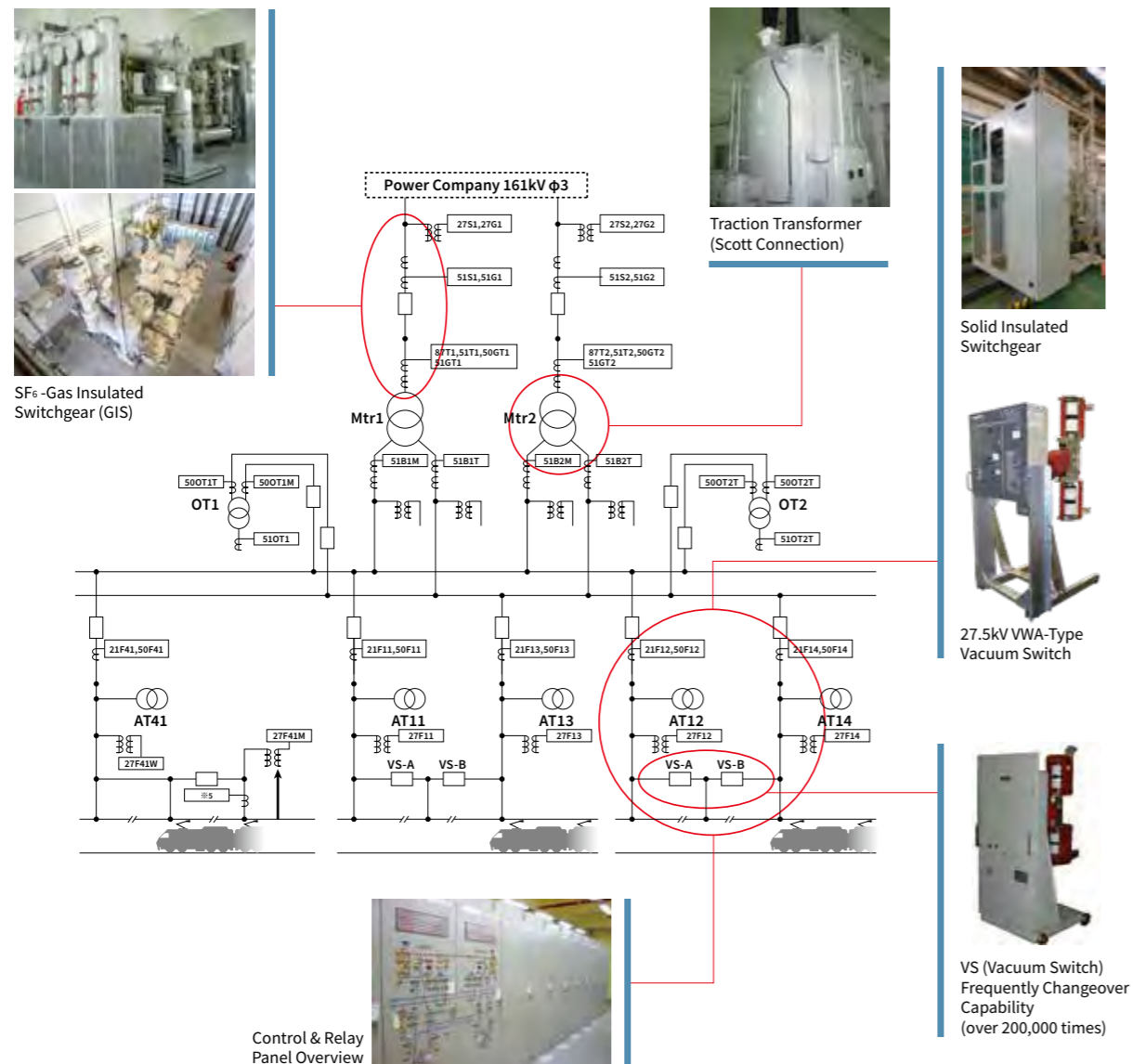

4-1

AC Traction Transformer

AC feeding power for rolling stock is single-phase power. The AC feeding substation should therefore convert the commercial AC 3-phase into AC single-phase. However in this case, it will cause three phase voltage unbalance at the primary side. Scott Connected and Roof-Delta Connected transformers are used for the AC traction transformer which can reduce the 3-phase voltage unbalance induced in the primary side.



Scott Connected Transformer

Ratings

Example of Scott Connected Transformer

Rated Voltage [kV]	220/27.5 x 2 ; 132/27.5 x 2
Cooling Type	ONAN / ONAF / OFAF
Rated Power [MVA]	60 / 80 / 100
Overload	150% (15mins), 200% (5mins) @ONAN Rating
Connection	Scott
Applicable Standard	IEC

Note: JEC Standards is also applicable



Roof-delta Connected Transformer

Ratings

Example of Roof-delta Connected Transformer

Rated Voltage [kV]	220kV / 60kVx2
Cooling Type	ONAN
Rated Power [MVA]	120
Overload	300% 2min
Connection	Roof-delta
Applicable Standard	JEC

Note: IEC Standards is also applicable

4-2

Autotransformer

Autotransformer is used for the AT Feeding System which reduces catenary voltage drops and electro-magnetic interference. It is designed with low impedance and to withstand the high short circuit current.



Auto-transformer

Ratings

Example of Autotransformer

Rated Voltage [kV]	60/30	
Type	ONAN	
Rated Power	Self Capacity [MVA]	10
	Line Capacity [MVA]	20
Overload	300% 2min	
Short Circuit Intensity	Can withstand thermally and mechanically for 25 or 35 times of the rated current	
Applicable Standard	JEC / IEC	

Note: IEC Standards is also applicable

4-3

Feeding Circuit Breaker / Switchgear (Solid Insulated Switchgear)

Toshiba offers a single-phase SIS for AC Feeding System. This next generation switchgear uses an improved insulation material in place of the conventional SF₆ gas which further enhances its functionality and reliability. Using epoxy resin material for insulation also allows both installation even in harsh environment and drastic reduction in space requirement. Furthermore, SIS has a modular composition which enables easier replacement, maintenance and customization.

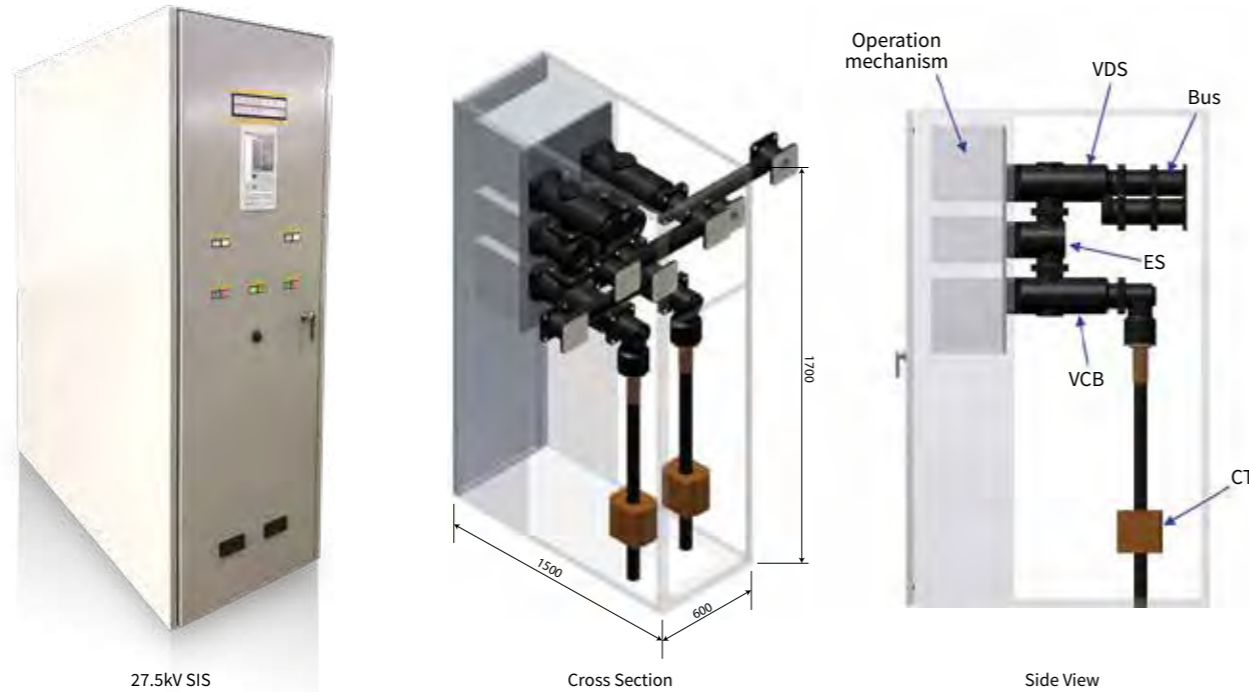

Single Line Diagram

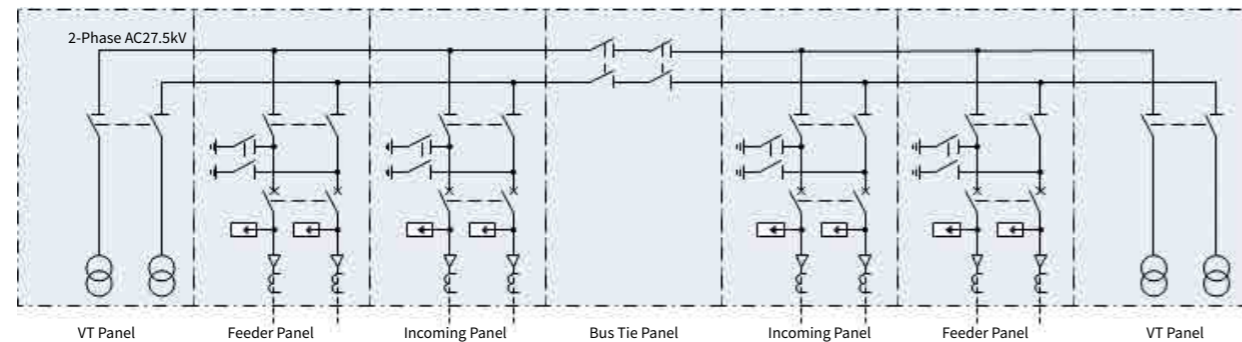

Ratings

Rated Voltage [kV]	27.5	
Rated Withstand Voltage (Line to Earth)	Lightning Impulse [kV]	200 (to earth and across open contacts) 220 (across isolating distance)
	Power Frequency [kV]	95 (to earth and across open contacts) 110 (across isolating distance)
Rated Current [A]	1250 / 2000	
Rated Short Time Withstand Current [kA]	31.5	
Applicable Standard	IEC	

Features	<ul style="list-style-type: none"> • SF₆ gas-less due to epoxy-resin coating • Compact Design • Outdoor Compatibility • Safe Operation • Low Maintenance • High Reliability
----------	--

4-4

Feeding Circuit Breaker / Switchgear (Gas Insulated Switchgear)

Dual or single-pole circuit breakers are used for AC outgoing feeders. These must demonstrate a long operating life and have a reclosing function. Individual gas circuit breakers (GCB), gas insulated switchgears (GIS), or cubicle type gas insulated switchgears (C-GIS) are used.



Ratings (C-GIS)

Rated Voltage [kV]	36 / 72	
Rated Bus Current [A]	1200	
Rated Breaking Current [kA]	16 / 25	
Rated Withstand Voltage	Lightning Impulse [kV]	200 / 350
	Power Frequency [kV]	70 / 140
Applicable Standards	JEC / IEC	

Features	<ul style="list-style-type: none"> • Compact Design • Outdoor Compatibility • Safe Operation • Low Maintenance
----------	--

4-5

Single Phase Vacuum Circuit Breaker

Toshiba's VCB designed for 27.5kV single phase AC feeding system uses high performance vacuum switches that are able to withstand high voltages and extensive switching cycles.

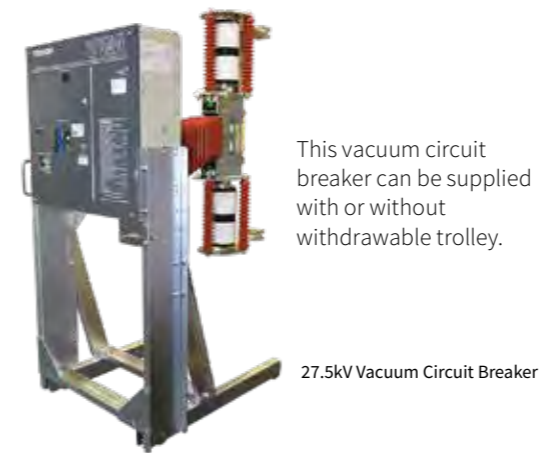

This vacuum circuit breaker can be supplied with or without withdrawable trolley.

Features	<ul style="list-style-type: none"> • High Voltage Withstand Capability In order to withstand the excessive voltage at the phase break point, two vacuum interrupters are provided in series for the switch. • Long Life Operation Aiming at long life operation, a simple electro-magnetic operation mechanism is used.
----------	---

Ratings

Rated Voltage [kV]	27.5	
Rated Current [A]	1250	
Rated Withstand Voltage	Lightning Impulse [kV]	250
	Power Frequency [kV]	95
Rated Short Time Withstand Current [kA]	25	
Applicable Standard	IEC	

4-6

Changeover Switch

Toshiba manufactures single pole vacuum switches (VS) for power switching at phase break points in AC high speed railway systems.



Changeover Switch

Changeover Switch in Cubicle

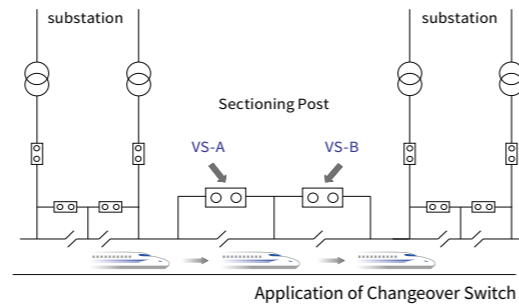

Application of Changeover Switch

Ratings

Rated Voltage [kV]	42	
Rated Current [A]	1200	
Rated Withstand Voltage	Lightning Impulse [kV]	Between Main Circuit and Earth 200 Between Main Circuit Terminals 250
	Power Frequency [kV]	Between Main Circuit and Earth 70 - 1min. Between Main Circuit Terminals 100 - 10min.
Rated Short Time Withstand Current [kA]	12.5 - 2sec.	
Switching Lifetime	Mechanical	200,000 times
	Electrical	100,000 times

Features

- **High Voltage Withstand Capability**
In order to withstand the excessive voltage at the phase break point, two vacuum interrupters are provided in series for the switch.
- **Long Life Operation**
Aiming for long life operation, a simple electro-magnetic operation mechanism is used.

4-8

Control / Relay Panel

The integrated control and relay panels are provided for AC feeding substations. They are designed with the advanced digital technology and consist of elements such as a digital protection relay, programmable logic controller (PLC), colored LCD touch screen, Ethernet LAN connection.



Control/Relay Panel

Features

- Colored LCD Touch Screen for Human Interface
- Redundant System
- Self-monitoring and Self-diagnosis Function
- Alarms and Commands Logs Function
- Measuring Data (voltage, current, power, power factor etc.)
- Connection with Remote Control Center (SCADA)

4-7

AC Feeding Protection Relay (GRY-200 Series)

GRY-200 Protection Relay is part of Toshiba's latest IED series specifically designed to meet global market requirement. It boasts of high functionality and flexibility. Furthermore, this relay also includes protection functions applied in highly reliable Japanese high speed railway system.

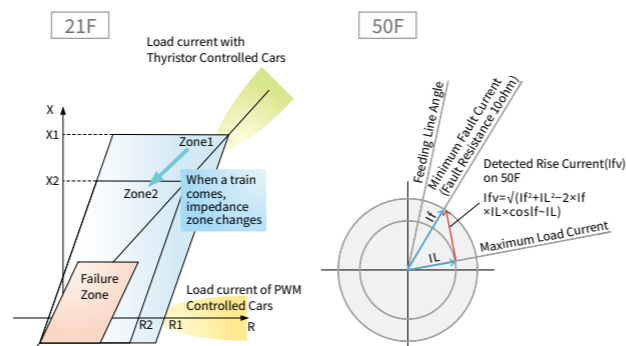

Ratings

Protection Function	21F	Distance Protection
	51F	Overcurrent Protection
	27F	Voltage Protection
	79	Automatic Reclose
	50F	Instantaneous Overcurrent Protection
Control Function	Multi-shots auto-reclosing function	
	Inter breaking function *	
	Controlling function (SWGR, CB)	
Metering Function	I, V, W, +Wh, Impedance	
Monitoring Function	Event records	
	Fault records	
	Disturbance records	
Record Function	CB and DS status	
	CB and DS response monitoring	
	Trip circuit supervision	
	Trip counter monitoring categorized by breaking level Self-supervision	

Features

- **Compact Design**
- **Colored LCD touch screen for human interface**
- **Flexible Installation** (The touch panel and the main unit are separated.)
- **Support a wide range of communication protocol**

Substation Monitoring System

Toshiba offers Substation Monitoring System by DMS (Digital Monitoring System) for Control/Relay systems. DMS stores and displays data of current, voltage, operation count, fault waveform, etc. System monitoring helps maintenance planning activities by utilizing tendency information of equipment in substations such as daily and monthly energy status reports, fault history, etc.

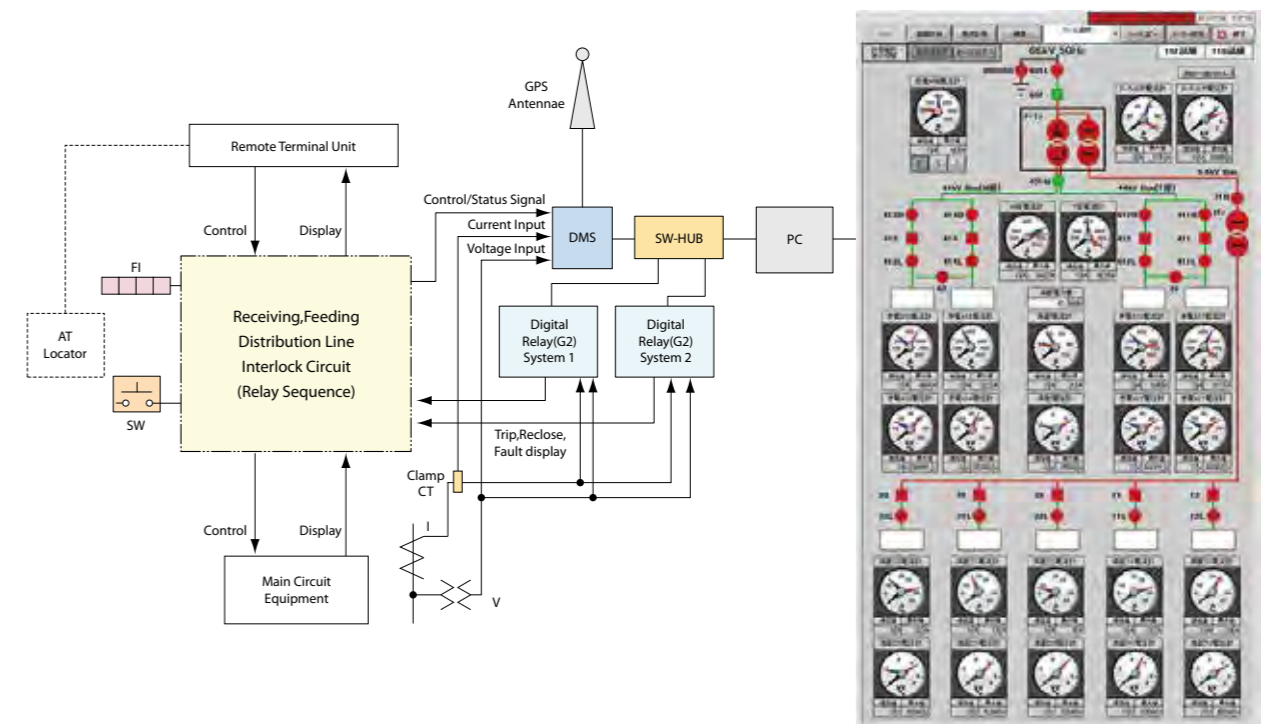

LCD panel (31.5 inch)

DC Electrification Systems

Toshiba also provides a highly-reliable and modernized DC electrification system. In addition to conventional equipment like rectifier transformers, rectifiers, and high speed circuit breaker (HSCB), a lot of new equipment has been developed with power electronics and digital technology. Toshiba presents innovative solutions to meet customers' needs.

Features

- For better environmental friendliness, a liquid silicone transformer or vegetable oil transformer can be used for the rectifier transformer.
- Heat pipe Rectifier has a very high thermal efficiency and can be installed outdoors.
- High Speed Vacuum Circuit Breaker (HSVCB) has high reliability, safety and can reduce maintenance
- Regenerative Inverter is a good energy saving solution for the efficient use of regenerative braking power from rolling stocks.
- Traction Energy Storage System (TESS) with SCiB™ is a regenerative energy storage solution which is not only useful for energy saving, but also for promoting power peak cut, line voltage compensation and emergency power supply.
- Package Type Substation saves space and construction works.

TOSHIBA's POWER SUPPLY SYSTEMS for DC Feeding Substation

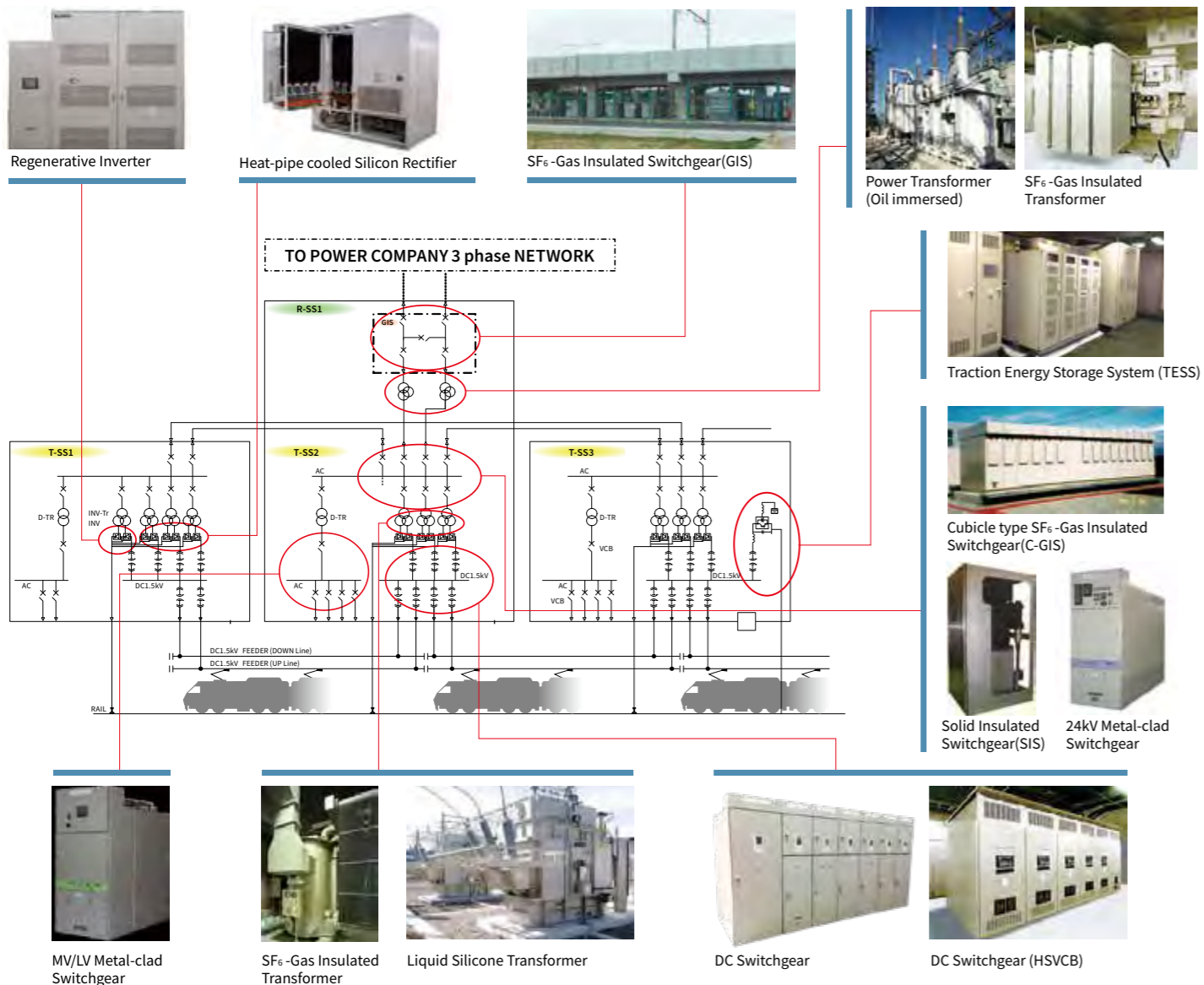

Rectifier Transformer

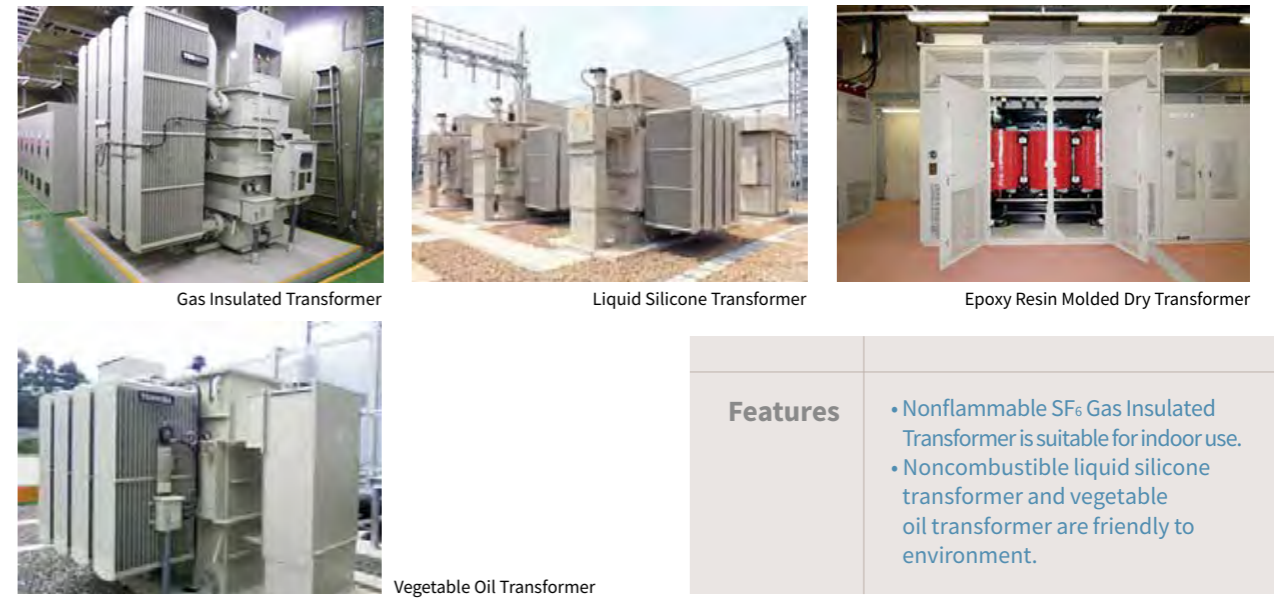

Features

- Nonflammable SF₆ Gas Insulated Transformer is suitable for indoor use.
- Noncombustible liquid silicone transformer and vegetable oil transformer are friendly to environment.

Ratings

Cooling and Insulating Method	Gas	Mineral Oil	Liquid Silicone	Vegetable Oil	Epoxy Resin
Rated Power	Applicable for up to 6MW Rectifier				
Rated Voltage	Primary	~ 77kV			~ 35kV
	Secondary	Applicable for DC600V / 750V / 1500V / 3000V			
Applicable Standard	JEC / IEC				

Traction Rectifier

Toshiba manufactures vertical heat pipe self-cooling rectifiers. This rectifier has a large cooling capacity which makes it suitable for systems with repetitive overload current and for outdoor installation.

Ratings

Cooling Method	Vertical heat-pipe self cooling
Rated Power	~ 6 MW
Rated Voltage	DC 600V / 750V / 1500V
Applicable Standard	JEC / IEC

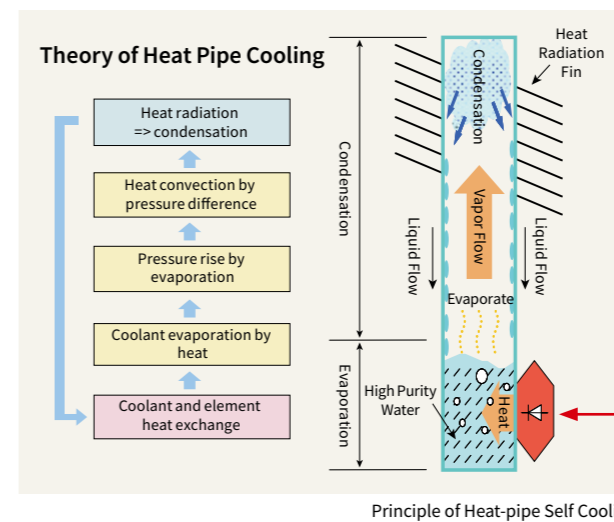

DC Switchgear

Toshiba offers HS6 Type DC Switchgear with its own DC Protection Relay which satisfies global market requirements. This highly reliable DC Switchgear efficiently undertakes its critical role in railway power supply systems while ensuring user safety and easy maintenance.

Ratings

Rated Voltage [V]	DC900 / 1800	
Rated Bus Current [A]	4000 ~ 12000	
Rated Short-circuit Making and Breaking Current [kA]	80	
Rated Withstand Voltage	Lightning Impulse [kV]	20
	Power Frequency [kV]	9.2
Applicable Standard	JIS / IEC	

Features

- Compact Design
- Combined with DC Protection Relay
- User-friendly Human Interface

Typical Configuration

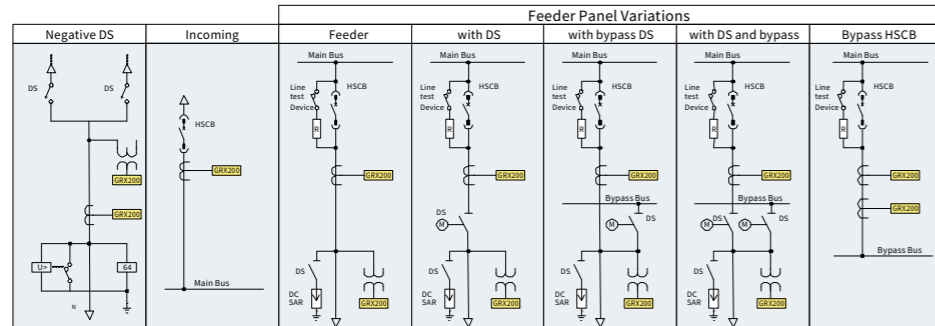

Various panel configurations such as feeder panels with DS, bypass DS and bypass HSCB, can be manufactured.

Front View

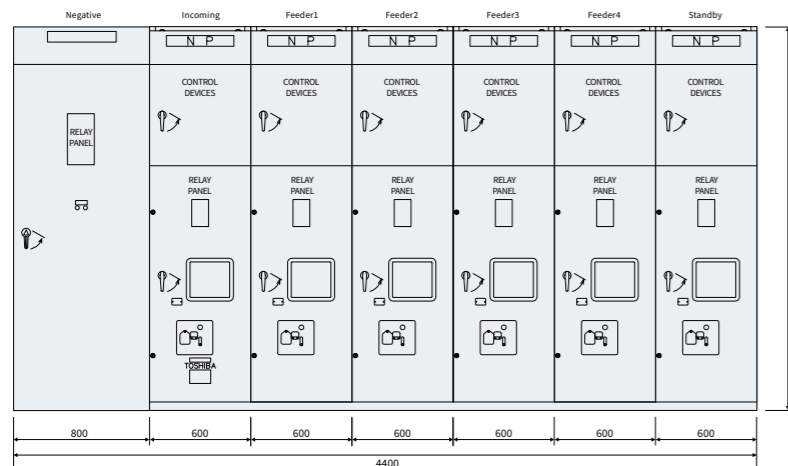

Side View of Feeder Panel

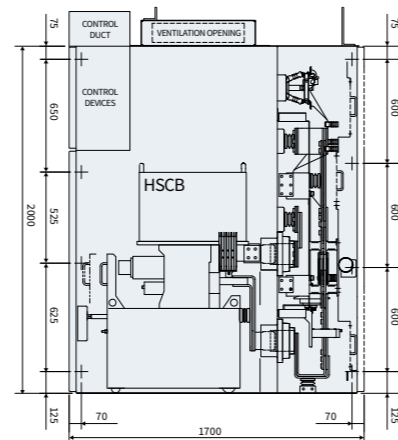

1500V DC Switchgear

Back View



Protection Relay (GRX-200 Series)

Ratings

Power Supply Ranges	100 ~ 250 Vdc
Communication Protocol & Interface	Modbus / IEC61850 / IEC60870-5-103 / Web browser / DNP3.0 etc
LCD Language	English / Chinese / Japanese
Applicable Standard	IEC

Protection	ΔI	Delta I protection
	di / dt	Current rate of rise protection
	50	Over current protection (4 stages)
	49	Thermal overload protection (3 stages)
	32	Reverse Overcurrent protection (4 stages)
	64	Grounding overvoltage protection (2 stages)
Control	59	Over voltage protection (2 stages)
	27	Under voltage protection (2 stages)
Metering	Multi-shots auto-reclosing function	
	Line test function	
	Inter breaking function *	
Record	Controlling function (SWGR, CB)	
	Section compensation function	
Monitoring	I, V, W, +Wh, -Wh, Impedance	
	Event records	
	Fault records	
	Disturbance records	
	CB and DS status	

* Communication lines between the substations are required.



GRX-200 Relay

Features

- Compact Design
- Colored LCD Touch Screen for Human Interface
- Flexible Installation (The touch panel and the main unit are separated.)
- Wide Range of Communication Protocol Supported
- Various Protection Elements

Section Compensation Function

When the train passes the section, sudden change of current might cause unnecessary trip. In order to avoid this situation, section compensation function is provided.

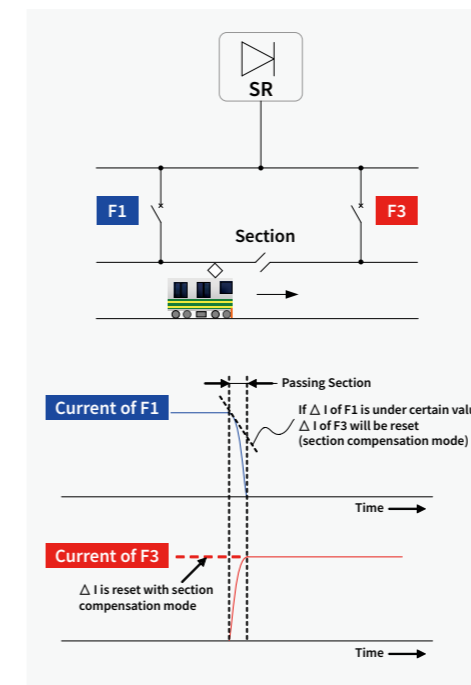

Section Compensation Principle

Human Interface

Through the relay's user-friendly HMI screen the circuit breaker can be operated and switchgear conditions can be checked.



Feeder Relay Mimic

Fault waveforms can be recorded, monitored and generated using the PC tool. This data can be used for detailed fault analysis during fault occurrences.



PC Tool for Fault Waveform Function

5-5

High Speed Vacuum Circuit Breaker (HSVCB)

The HSVCB consists of VCB, Capacitor, Control and Protection units. HSVCB configuration eliminates the use of arc chute and contactor promoting safe operation and easy maintenance.



Outline of HSVCB

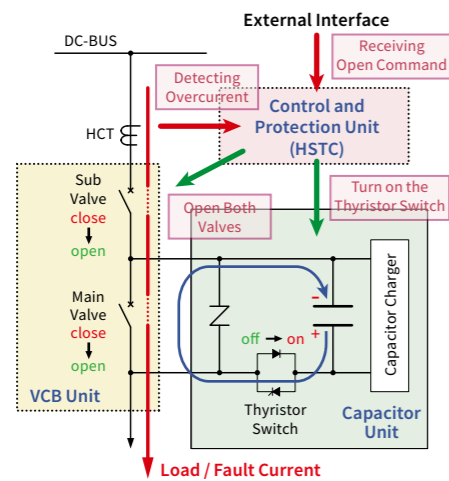

Principle of Cutting off DC Current by HSVCB

Features

- **Safe Operation**
No arc occurs during current breaking due to VCB application.
- **Low Noise**
VCB application allows low noise.
- **Low Maintenance**
Maintenance is free from aerial arc chute and the contactor.

Ratings

Rated Voltage [V]	DC 750, 1500
Rated Current [A]	3000, 4000
Rated Breaking Capacity [kA]	50 (at 3×10 ⁶ A / sec), 100 (at 10×10 ⁶ A / sec)
Rated Short Time Current [kA]	50-1sec, 100-1sec
Applicable Standard	JIS (To be developed for IEC)

When control and protection unit detects the over current or receives open command from external devices, the both valves trip and the thyristor switch of capacitor unit is turned on. Since the current of capacitor unit is in the opposite direction of the load/fault current, the zero-cross point of DC current can be achieved. Therefore, the DC load/fault current can be broken with high reliability and safety.

5-6

Package-Type DC Substation

Toshiba has developed the compact "Package-Type DC Substation". It is suitable for small-capacity substations and temporary substations during rehabilitation work, and it reduces substation space.

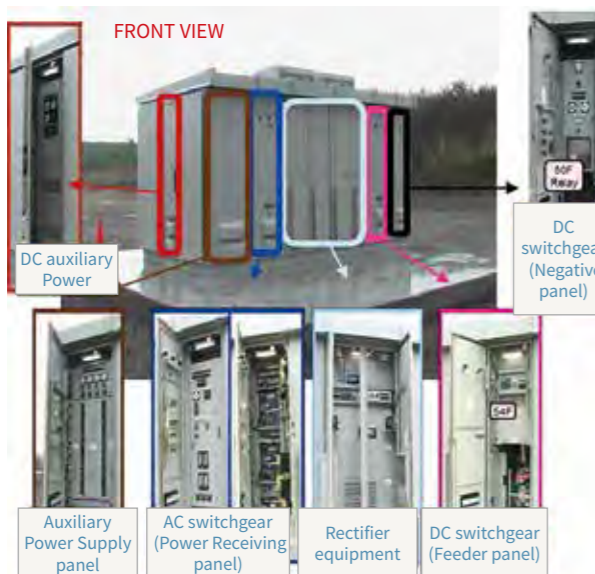

Outline of Package-Type DC Substation

Features

- Compactness
- Flexible Layout
- Short Construction Period

Ratings

	Specifications	Applicable equipments
MV Switchgear Unit	7.2 / 24 / 36kV	Air Insulated type or Solid Insulated type
12-Pulse Rectifier Unit	Up to 2,000kW	TR : Epoxy Resin Molded Dry / Liquid Silicone SR : Heat-pipe Self-cooling
DC Switchgear Unit	DC 600V, DC1500V	HSCB or HSVCB
Auxiliary Power Supply Unit	DC 110V, AC 105V / 210V	Lead Storage Battery

5-7

Traction Energy Storage System with SCiB™

System Overview

Toshiba developed Traction Energy Storage System (TESS) with SCiB™, an energy saving solution with Toshiba's own battery technology of high quality. TESS efficiently charges and discharges surplus regenerative energy to/from SCiB™. TESS is installed with Toshiba's patented advance V-SOC (Voltage-State-of-Charge) control system which allows flexible control of charge-discharge characteristics in accordance to the battery's State-of-Charge (SOC). This allows significant increase in battery lifetime. This system is useful not only for energy saving, but for various purposes such as regenerated energy absorption, peak cut, line voltage compensation and emergency power supply.

High performance SCiB™

TESS utilizes Toshiba's own high performance SCiB™. This battery has various outstanding characteristics. By using unique oxide materials, SCiB™ holds high resistance against thermal runaway caused by internal short circuiting brought about by physical stresses.



Crush Test for SCiB™ Cell Battery

Ratings and Specifications

Item	Rating / Function	
Rated Line Voltage	DC 750V (DC 600V and DC 825V are also available)	DC 1500V
Rated Power	500kW - 2000kW	1000kW - 4000kW
Applicable Load Pattern	Class I - IX (IEC 62924) 0.75(p.u.) continuous	Class I, IV, VI - IX (IEC 62924) 0.5(p.u.) 60s + 0.25(p.u.) 240s (cycle time: 300s)
Rated Capacity	146kWh - 777kWh	
Rated Battery Voltage	DC 600V (530V ~ 713V)	
Operation Mode	1. V-SOC Mode - Charge and Discharge corresponding with feeding voltage and SOC. Voltage stabilization of transient fluctuation is also available. 2. Emergency Power Supply Mode - Discharge energy without power from grid.	
Control Function	1. V-SOC Control 2. Monitoring 3. Sequence Control 4. Schedule Control 5. Data Logging (Option) 6. Remote Maintenance (Option)	
Applicable Standard	IEC / JEC	

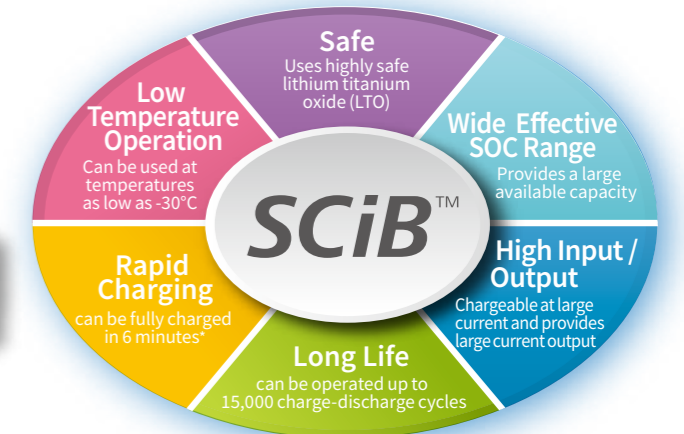

*Results of cell level tests under certain conditions. Not a guaranteed performance.

System Outline

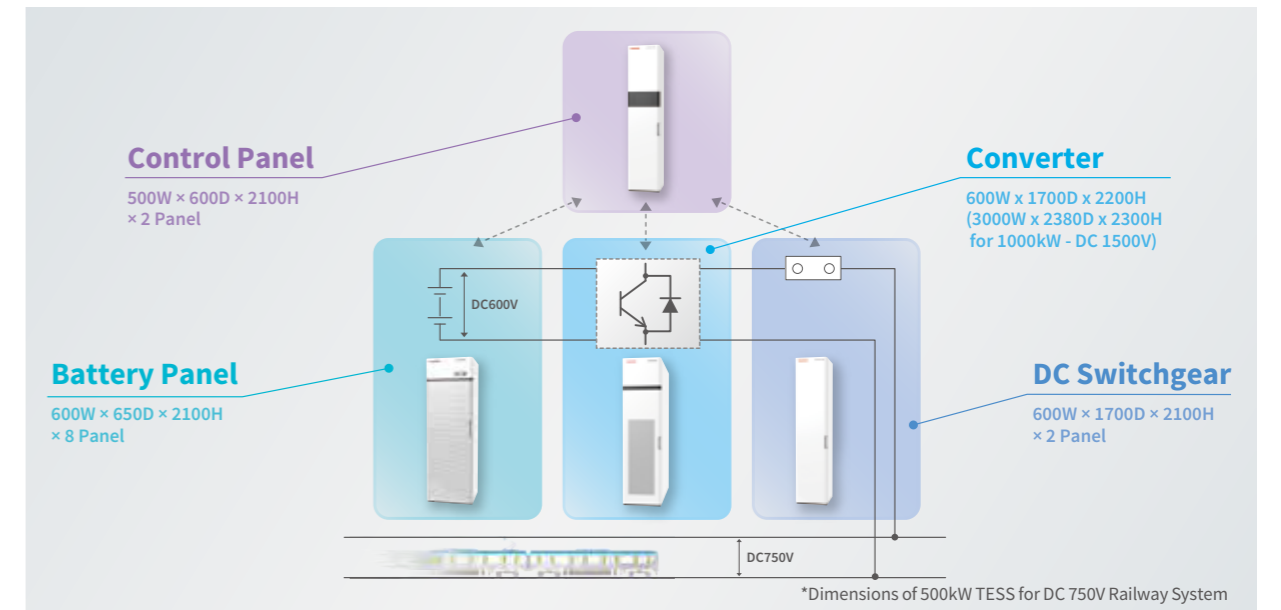

*Dimensions of 500kW TESS for DC 750V Railway System

Regenerative Inverter

The regenerative inverter is a solution for regenerative braking power from rolling stocks. It converts the DC regenerative power back to AC power and supplies it to the auxiliary system for passenger stations. Toshiba supplies the IGBT inverters with heat pipe cooling systems.

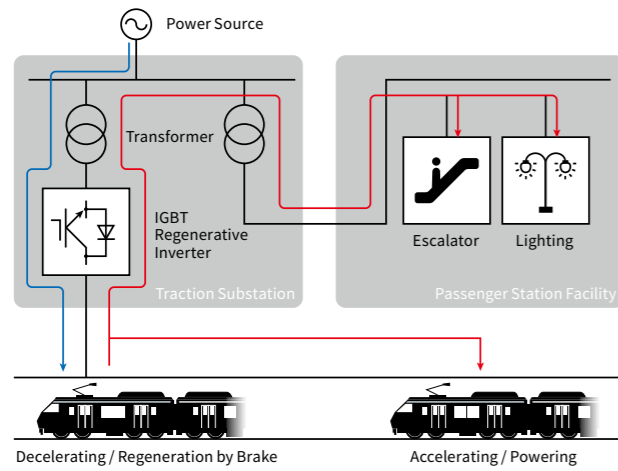

Regenerative Inverter

Ratings

Capacity	Regenerating Inverter mode	1,000kW - continuous rating
		3,000kW - 1minute or 4,500kW-30seconds
	Powering Converter mode	1,000kW - continuous rating only
Rated Input Voltage	1,500VDC Output control mode (Make a selection for your operation) -1) Load control: To 6% or 8% output regulation -2) Constant voltage control	
Rated Output Voltage	1,200VAC	
Main Circuit Configuration	1Series * 2Parallel * 6Arm * 2Bridge Double bridge parallel configuration by Transformer	
Device	IGBT (3,300V-1,200A) / MG1200FXF1US53(P)	
Device Cooling System	Heat-pipe in pure water (natural cooling type)	
Dimension	Inverter-2,700W * 2,200D * 2,900H	
	Control Panel of Inverter-800W * 1,000D * 2,300H	
	DC Reactor-2,800W * 2,000D * 2,500H	

Power SCADA

Overview

Toshiba produces Supervisory Control And Data Acquisition (SCADA) systems for railway power supply systems with ICT which enables stable and highly-reliable train operations. Toshiba's abundant expertise allows for production of user-friendly systems. For instance, when a fault occurs on the distribution network, many fault signals will be sent simultaneously from some substations to the SCADA server in the Control Center. The operator would subsequently become confused by the many faults and alarms. Our system therefore collects related information and displays what originally happened, and then activates recovery control or shows the recovery procedure to the operator. In addition, the simulation function provides training for immediate and exact recovery. Toshiba takes customers requirements into account in its flexible approach to producing SCADA systems.



Features

- 1. High Reliability by Triple Servers**
The triple-server system enables highly reliable operation. It can allow duplex servers operation even while maintenance and training. Of course, each of the three servers can be changed automatically or manually to service, standby or simulation mode.
- 2. Server-less Manual Control on Console**
The substation monitoring and the individual manual control functions are installed in the Console PC. These functions are therefore available even if the connection between the servers and Remote Terminal Unit (RTU) fails.
- 3. Remote Back-up Console for Emergencies**
Installing the Console PC in the substation makes remote back up control possible from the substations.
- 4. Registered Sequential Control**
This function controls multiple local equipment sequentially with one action. The operator can define and register the condition, equipment to be controlled, and sequence depending on their usability.
- 5. Fault Recovery Control**
In case of a fault in some substations or the distribution network, the fault recovery control (consisting of reclosing tripped circuit breakers, fault location control, etc.) will be done automatically or manually while displaying recovery procedure to facilitate immediate and exact recovery.
- 6. Simulation (Training)**
This function provides training for operators and conducts test for maintenance with a pair of servers and with the operator console in off-line status with all substations. Playing the "Simulation Scenario" which can be made from actual event logs simulates faults and circuit breakers tripped as if actual accidents had happened. This allows the operator to experience training that is effective for immediate and exact recovery.

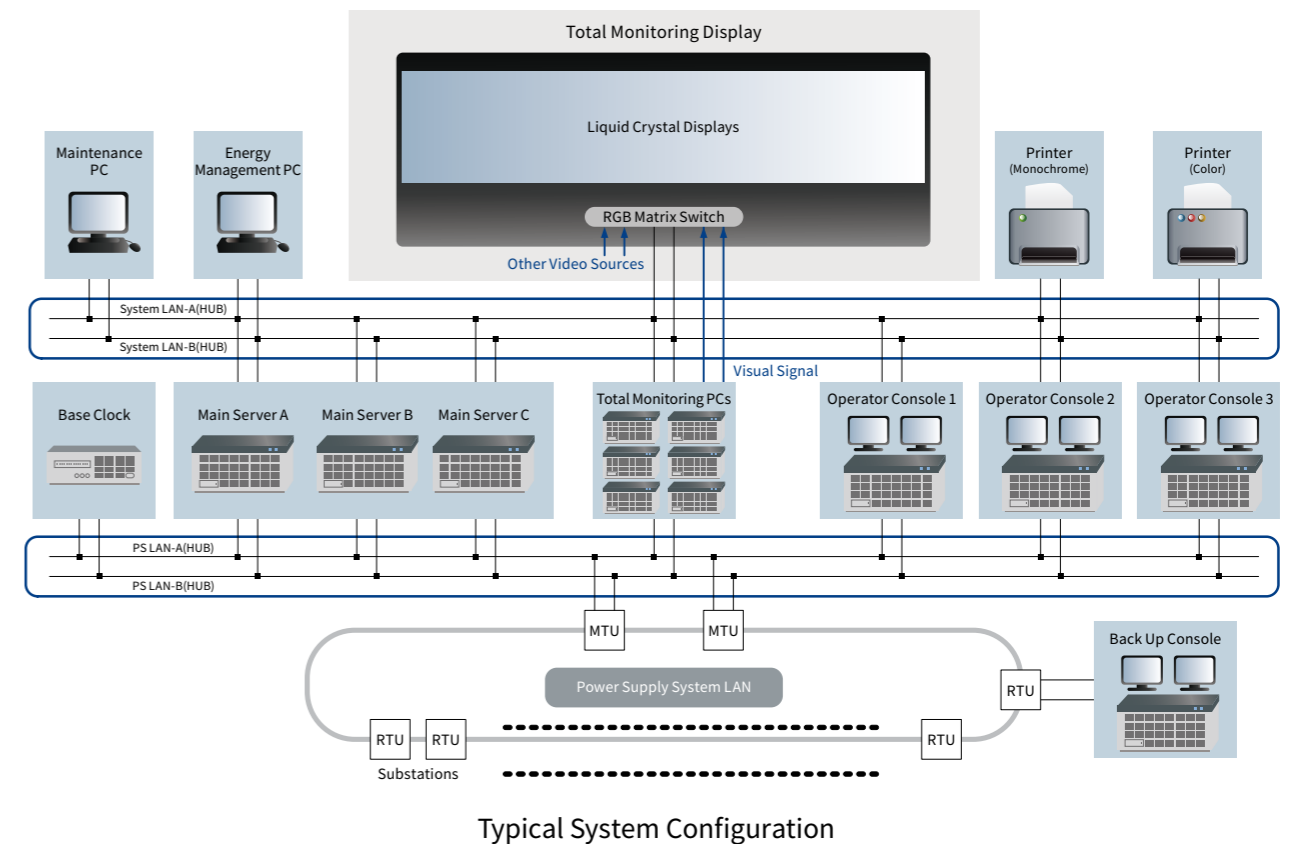

Typical System Configuration