



Technical and economic feasibilities Requirements and methodology for assessment

Rubén Pérez-Aranda
rubenpda@kdpof.com

Introduction



- The Study Group has to address the technical feasibility and economic feasibility criteria as part of the CSD/5C
- Technology leveraging is important for these two criteria:
 - The existence of state of the art technologies that are mature and can be reused as part of the system that wants to be standardized can prove the technical feasibility via testing
 - Technologies leveraging with economy scale can prove the economic feasibility of the project
- A set of technologies that may be leveraged are presented, also providing the expected automotive requirements that they should meet
- Key parameters of critical elements that compose the communications system are identified, which should be obtained by testing, modeling or simulation to address technical feasibility
- A general approach based on Shannon's capacity analysis is proposed to demonstrate the technical feasibility



Technology Leveraging and Automotive Requirements

Technology Leveraging & Automotive requirements



- IEEE Std 802.3 already includes the 10, 25 and 50GBASE-SR specifications that may be considered as starting point to develop multi-gigabit optical PHY specification for automotive applications
 - nGBASE-SR are based on 850nm VCSEL, MM graded-index glass fiber, GaAs PIN diode
 - However, are they really suited for automotive applications?
- Key differences between nGBASE-SR and the Automotive requirements:
 - Ambient temperature grades per AEC-Q100:
 - Grade 2: $T_a = -40^{\circ}\text{C} - 105^{\circ}\text{C}$
 - Grade 1: $T_a = -40^{\circ}\text{C} - 125^{\circ}\text{C}$
 - Grade 0: $T_a = -40^{\circ}\text{C} - 150^{\circ}\text{C}$
 - Grade 2 imposes junction temperature range $T_j = -40^{\circ}\text{C} - 125^{\circ}\text{C}$ (power < 1W / port)
 - 15 years operation, 0 ppm failures
 - VCSEL reliability
 - Higher insertion loss channel
 - Higher optical return loss channel
 - Lower relative cost and power consumption
 - OAM side-channel for dependability and link management

Technology Leveraging: VCSEL

- VCSEL is the least “reliable” element compared with CMOS IC and PIN PD
 - VCSEL lifetime decreases with current increase
 - VCSEL lifetime decreases with temperature increase
- VCSEL current density has to be reduced to achieve good reliability at $T_J = 125\text{ }^\circ\text{C}$
- Current density reduction impacts on the VCSEL performance
 - Bandwidth is highly reduced
 - Relative intensity noise (RIN) is increased
 - Optical power is decreased
- VCSEL process variation is big: e.g. oxide aperture area -40% — +60%
 - Different lots with different **current densities** (i.e. reliability) under same driving conditions
 - Different lots with different **bandwidth** under same driving conditions
 - Different lots with different **noise** under same driving conditions
 - Different lots with different **optical power** under same driving conditions
- **Adaptive electronics** would allow high yield and make the port economically feasible



Technology Leveraging: VCSEL

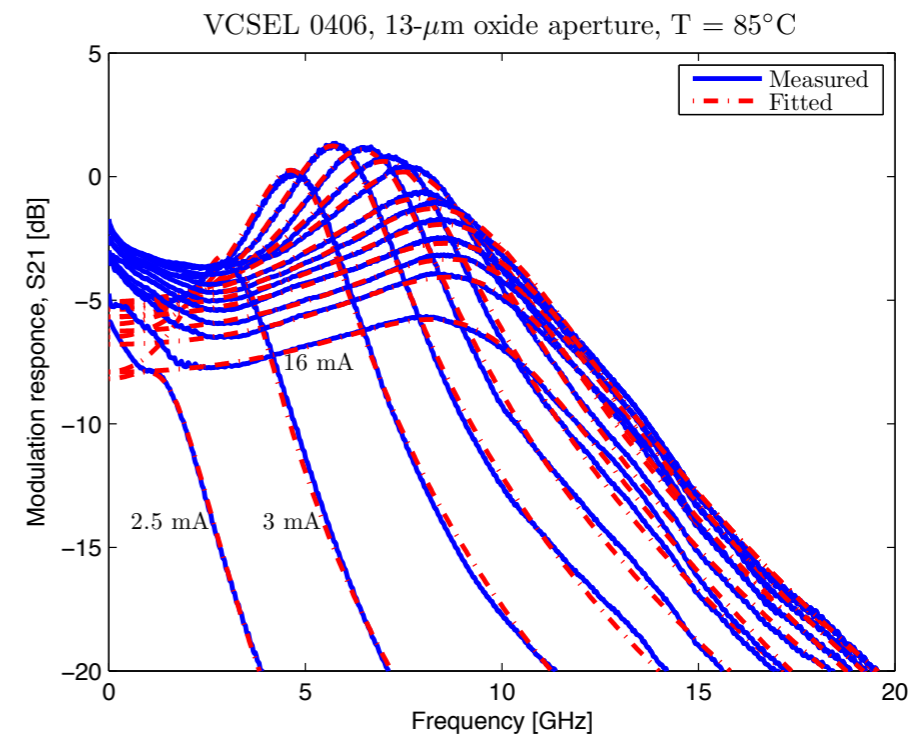
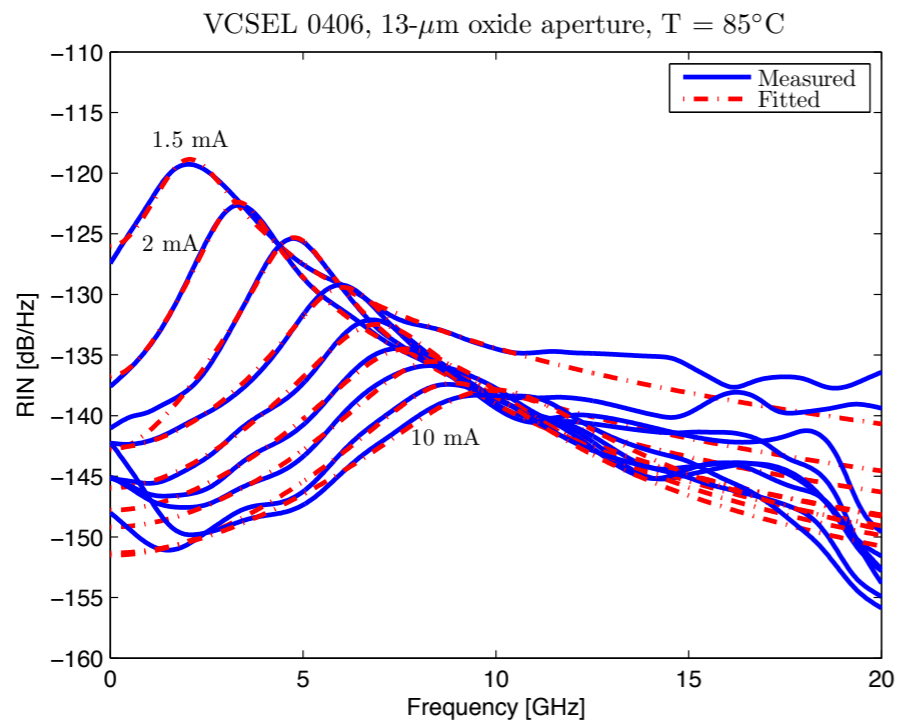
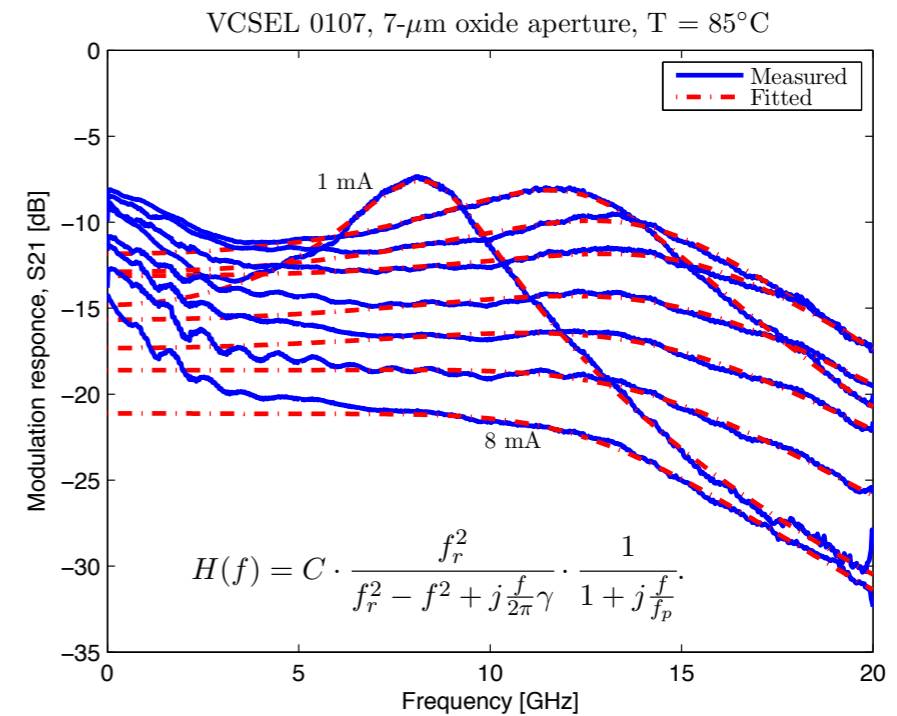
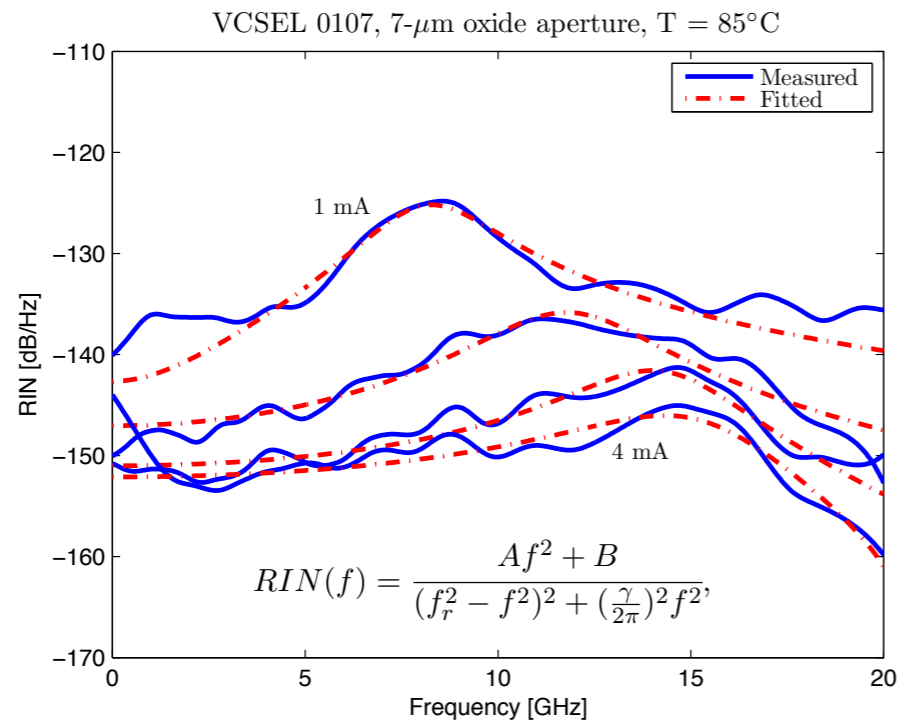

Relative Intensity Noise (RIN) in High-Speed VCSELs for Short Reach Communication, Master of Science Thesis in Photonics Engineering, SEYED EHSAN HASHEMI, Photonics Laboratory, Department of Microtechnology and Nanoscience (MC2) CHALMERS UNIVERSITY OF TECHNOLOGY Göteborg, Sweden, 2012

Technology Leveraging: VCSEL

NRZ 10.3125 GBd eye diagram, **low bias current: long lifetime**

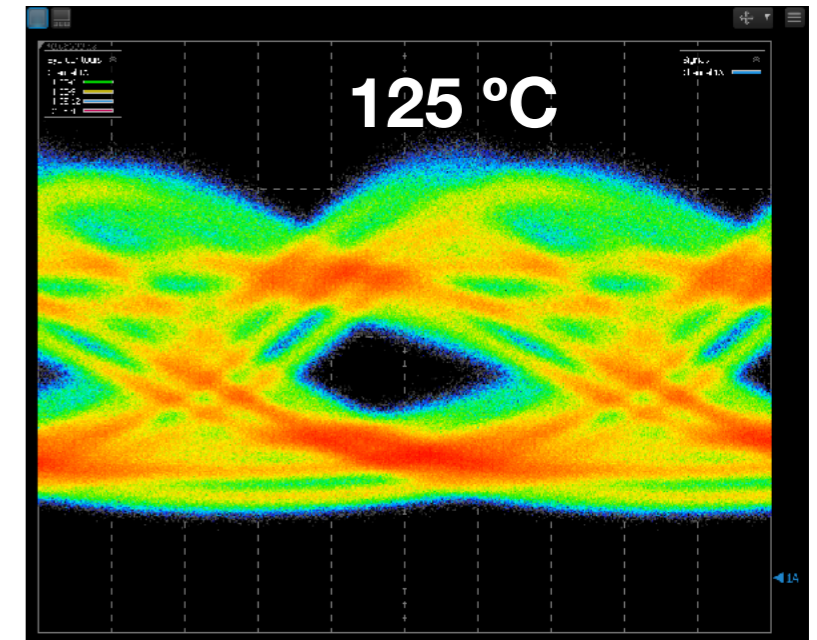
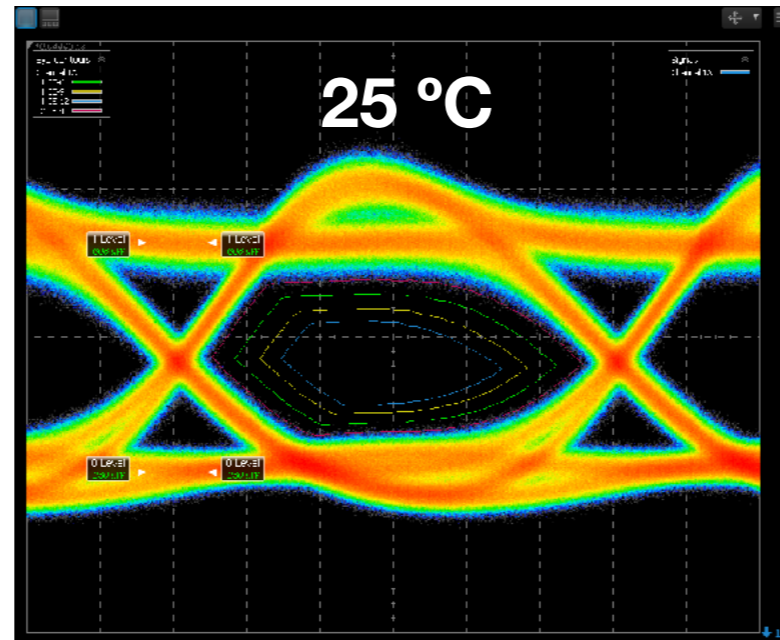
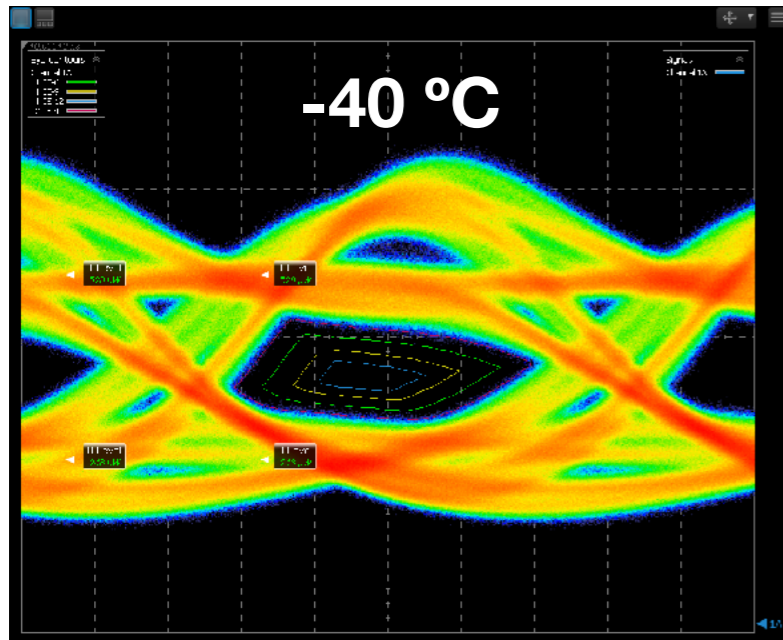

NRZ 10.3125 GBd eye diagram, **high bias current: short lifetime**

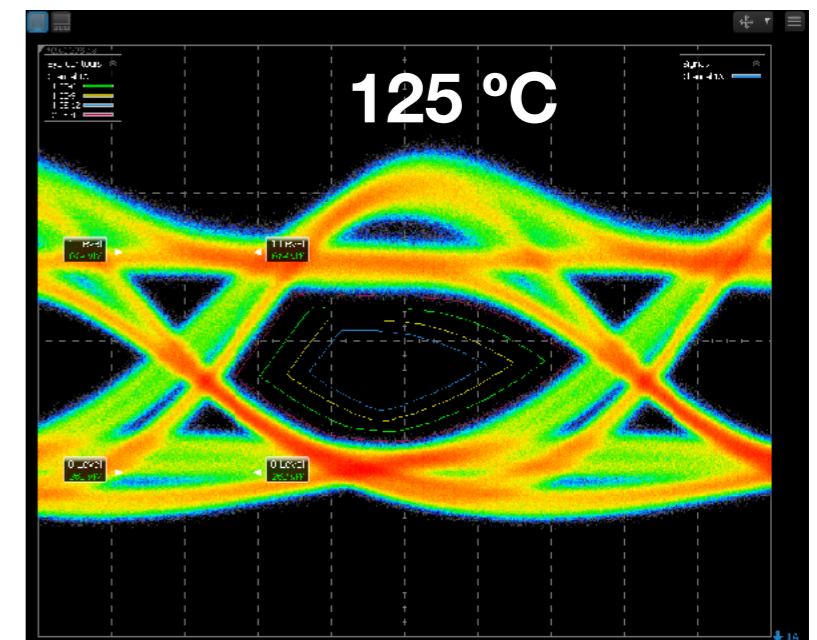
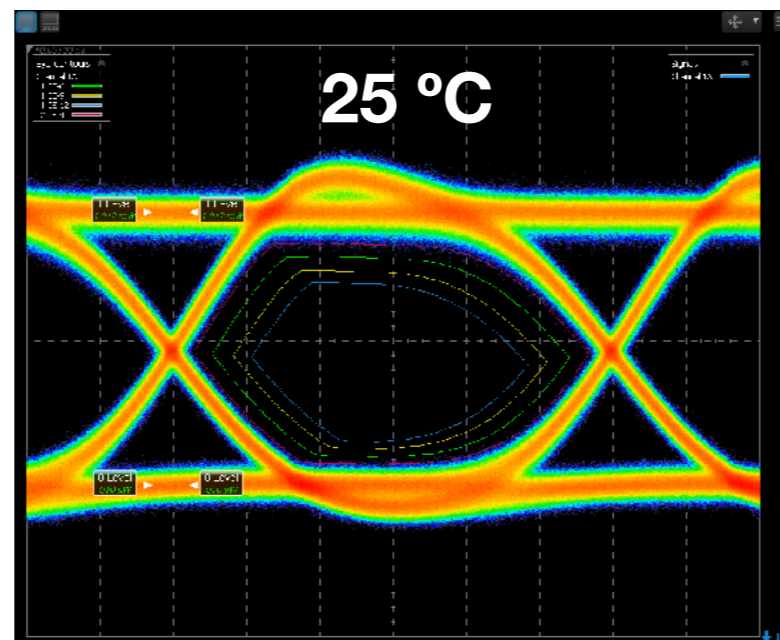
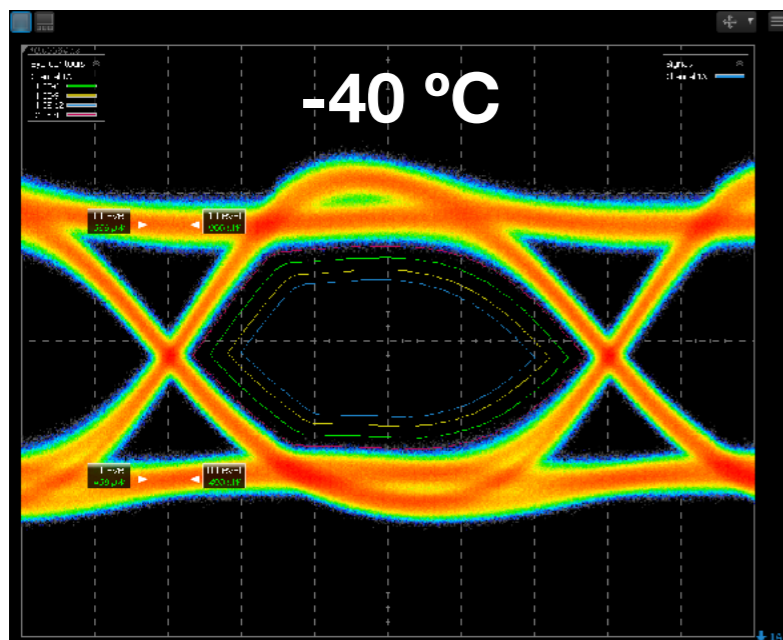

KDPOF: 850nm VCSEL time-domain characterization, based on Keysight DCA-M N1092C, optical input.

Technology Leveraging: VCSEL



- Lifetime increases as $\sim 1/(\text{current})^7$
- VCSEL feasibility study should involve: signal response, noise and reliability
- HTOL experiments have to be conducted with different VCSEL corner lots (i.e. different oxide apertures) and currents for technical feasibility assessment

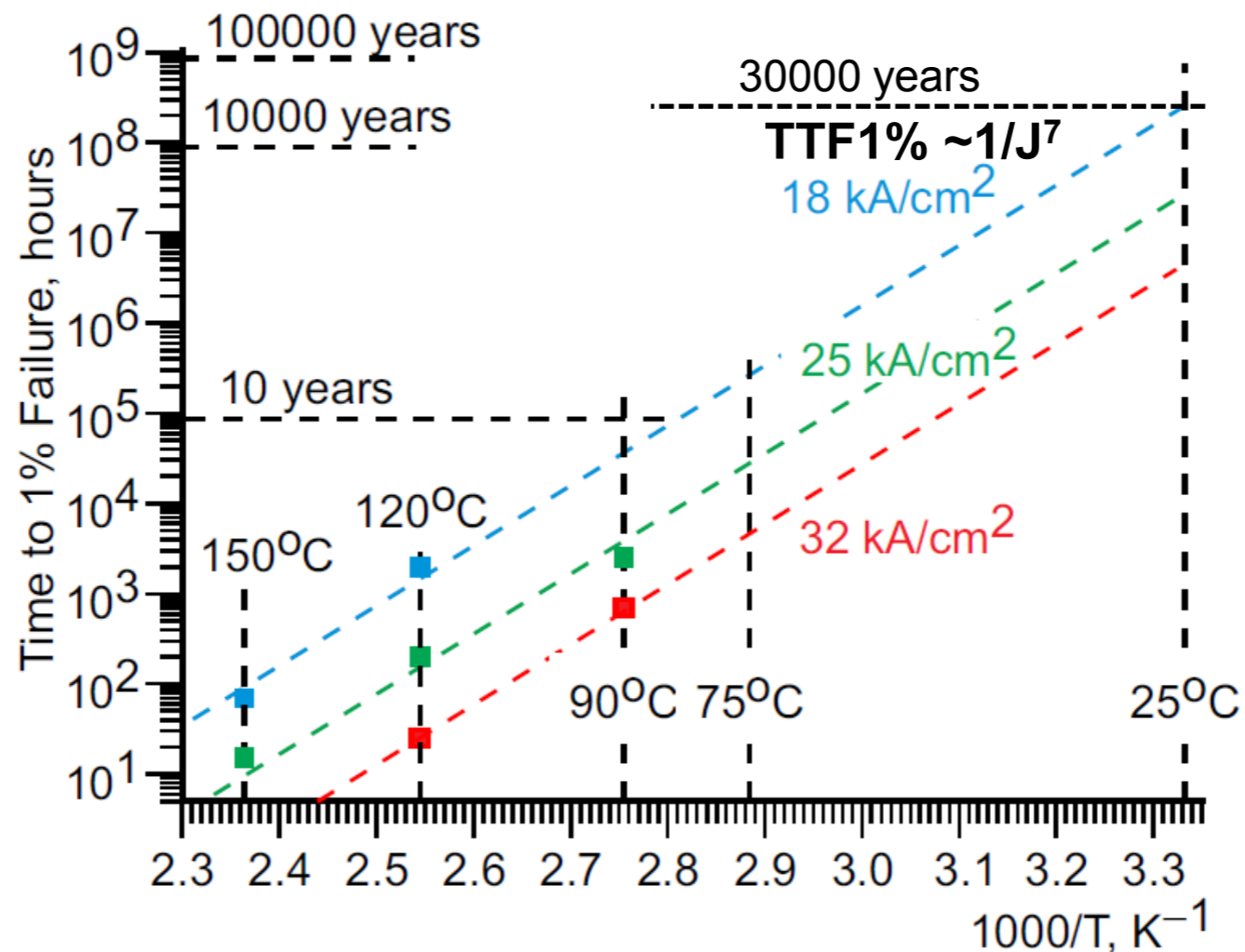

Accelerated aging of 28 Gb s⁻¹ 850 nm vertical-cavity surface-emitting laser with multiple thick oxide apertures, J R Kropp, G Steinle, G Schäfer, V A Shchukin, N N Ledentsov, J P Turkiewicz and M Zoldak, Published 19 February 2015 • © 2015 IOP Publishing Ltd

Automotive requirements: Channel



- Optical cables and connectors should follow the same requirements and test methods of electrical cables, as far as applicable:
 - ISO/ SC32/ TC22/ WG6 = connectors,
 - ISO/ SC32/ TC22/ WG4 = cables
- Automotive target:
 - Channel length \leq 40 meters
 - Max expected 4 inline connectors
 - Operation temperature (for optical performance): -40°C to $+125^{\circ}\text{C}$ (expected)
 - Aging temperature (for mechanical and chemical robustness): -40°C to $+125^{\circ}\text{C}$ (expected)
 - Installation temperature (for short term mechanical installation stress): $+10^{\circ}\text{C}$ to $+30^{\circ}\text{C}$ (expected)
 - Mechanical loads: vibrations, shock, push-, pull-, twist/torsion-forces on cable, on connector and a mated pair, cyclic bending, edge impact, static torsion
 - Chemical loads: liquids, water, greases and oils, corrosive gases, dust
 - Flame resistance
 - Connector position assurance, connector to be blind mate-able, connector to lock with audible sound
 - Kojiri protection / scoop proof: no risk damage on connector parts due to handling while assembly operation
 - In car assembly process, in field repairation

Technology leveraging: Channel



- BASE-SR optical fibers with high economy scale in data-centers:
 - OM1: MM graded index glass optical fiber 62.5/125 μm
 - OM2: MM graded index glass optical fiber 50/125 μm
 - OM3: laser (VCSEL) optimized (index profile) MM glass optical fiber 50/125 μm (the highest volume today)
 - OM4 and OM5: as OM3, with further reduced modal dispersion (optimized index profile)
- BASE-SR optical connectivity:
 - LC connectivity technology is the most extended with physical contact: IL < 0.25 dB
 - PHYs provide very low link budget
 - Physical contact LC produces small back reflection, therefore low RIN from VCSEL
- Any kind of high-bandwidth low-attenuation optical fibers as well as optical connectivity technologies that may be suitable for automotive applications should be considered by the SG in the technical and economic feasibility assessment:
 - MM 62.5/125 μm , MM 50/125 μm , GIHCS, GIPOF

Technology Leveraging: Channel



- Optical fibers used in harsh industrial environments
 - GIHCS 50/200 um (similar optical performance of OM2)
 - GIHCS 62.5/200 um (similar to OM1)
- Applications:
 - Factory floor, Wind turbines, Solar power plants,
 - Rail applications, Electrical power plants, Electrical switching,
 - Aerospace, Digital radio connections in aircrafts
- Fiber is terminated with LC connectors in the field, with C&C (Crimp and Cleave) fast process
 - Air-gap connection due to ~10 um fiber recession inside LC ferrule
 - Insertion loss is bigger: $IL_{\max} = 1.5$ dB
 - Back reflection is much higher due to the refractive index mismatch: higher VCSEL RIN
- Other connectors supported: ST, SMA, SC.
- **RIN** (e.g. RINxOMA) specification should be considered from very beginning in the technical feasibility, because it is expected to be much higher with respect to BASE-SR, because **higher temperature, lower current bias, higher back reflections**

Technology Leveraging: Channel – GIHCS

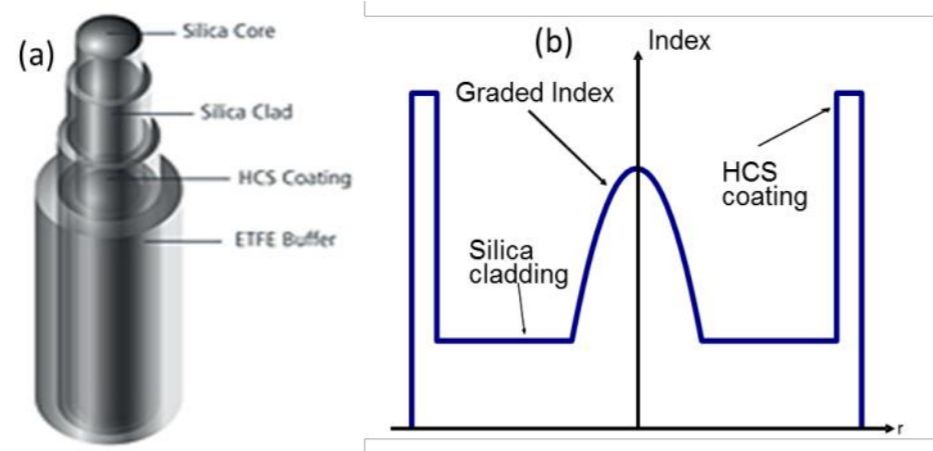

Figure 1. Schematic of GIHCS fiber and index profile

Critical properties	Fiber design 62.5/200 μm	Fiber design 50/200 μm
Core diameter	62.5 +/- 3 μm	50 +/- 3 μm
Cladding diameter	200 +/- 4 μm	200 +/- 4 μm
Coating diameter	230 +0/-10 μm	230 +0/-10 μm
Buffer diameter	500 +/- 30 μm	500 +/- 30 μm
Core/coating offset	< 5 μm	< 5 μm
Proof test level	150 kpsi	150 kpsi
Numerical aperture	0.275 nominal	0.200 nominal
Bandwidth-length @850 nm	>200 MHz·km	>400 MHz·km
Bandwidth-length @1300 nm	>500 MHz·km	>400 MHz·km
Bandwidth-length @850 nm	< 3.5 dB/km	< 2.8 dB/km
Bandwidth-length @1300 nm	< 1.2 dB/km	< 1.0 dB/km

Field termination

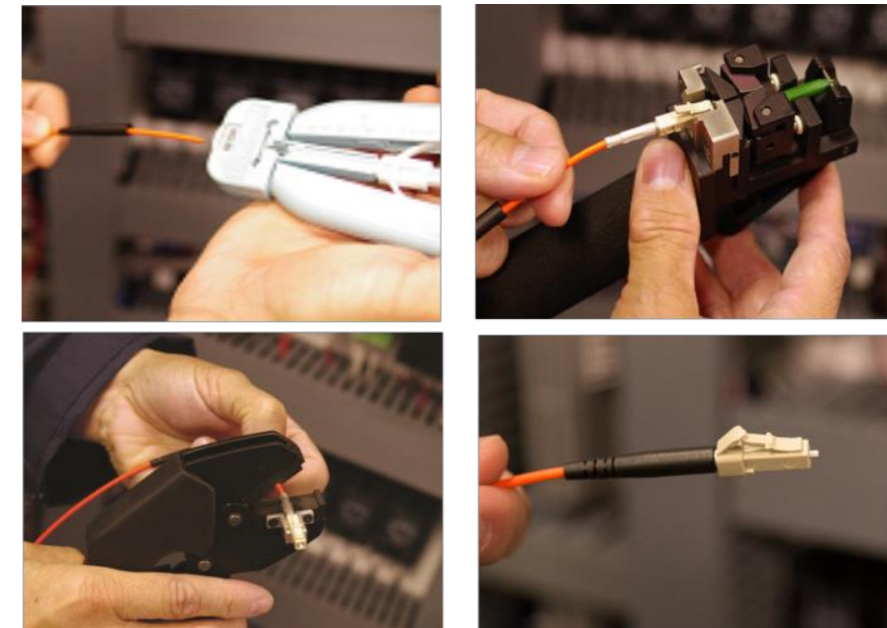
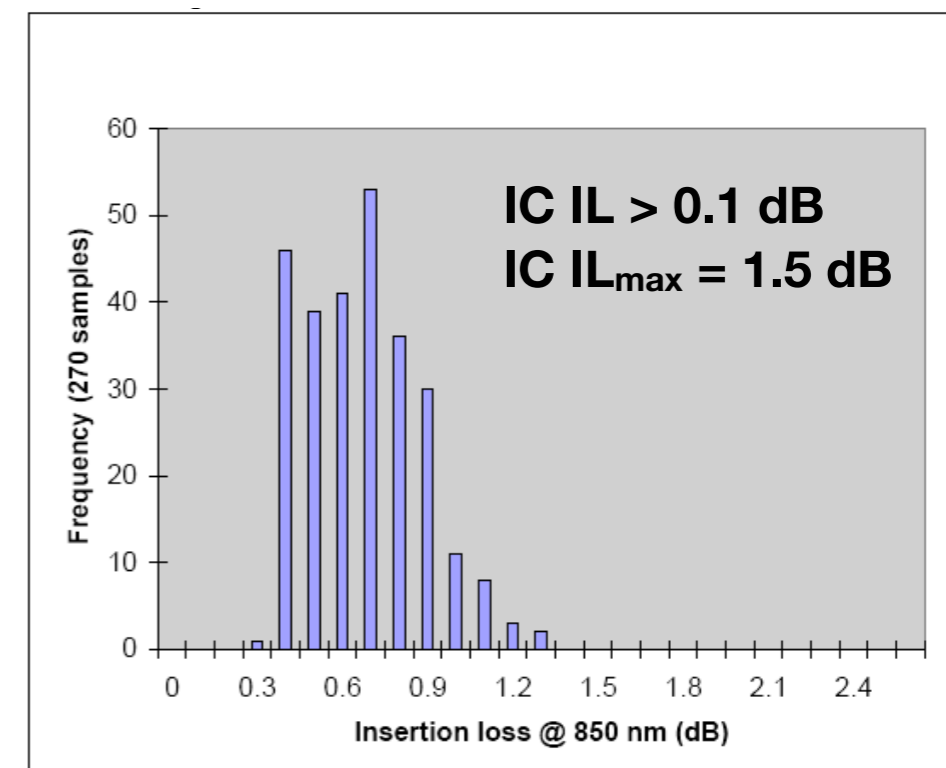

Figure 3. The termination process for C&C LC connector



Technology Leveraging: Channel – GIHCS



- KDPOF characterization of Inline Connectors IL
- Fiber under test: GIHCS 62.5/200/230 μ m:
 - TX AOP = -2.5 dBm (mean)
 - Fiber Attenuation < 3dB/Km at 850nm per data-sheet
 - Measured insertion Loss per In-Line Connectors < 1 dB, implemented with LC-LC adaptor

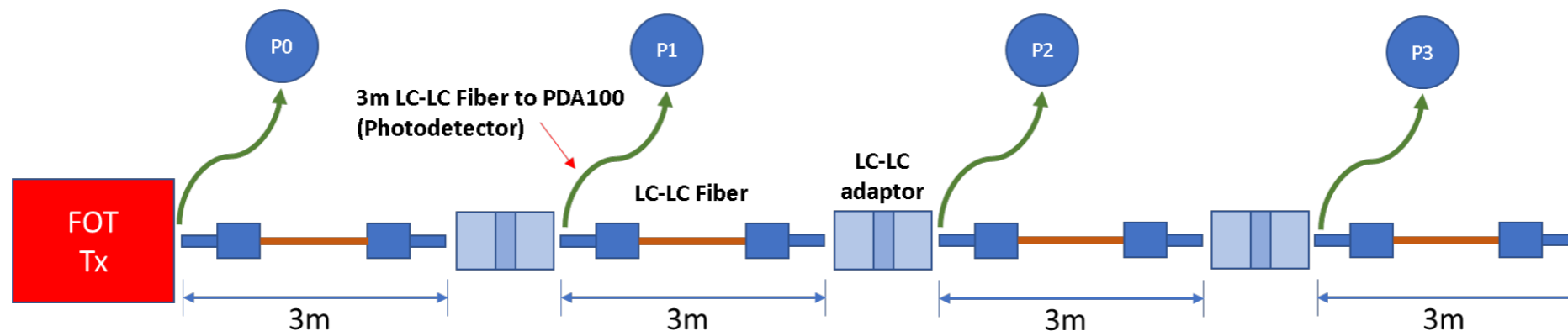

Tet Point	Length (m)	In-line Conn. #	AOP (dBm)	IL/In-Line Conn. # (dB)
P0 AOTPT2	3	0	-2.497	0.000
P1	6	1	-3.113	0.615
P2	9	2	-4.003	0.753
P3	12	3	-5.085	0.862
P4	15	4	-5.917	0.855
P5	18	5	-7.168	0.934
P6	21	6	-8.263	0.961
P7	24	7	-9.163	0.952
P8	27	8	-10.079	0.948
P9	30	9	-10.784	0.921

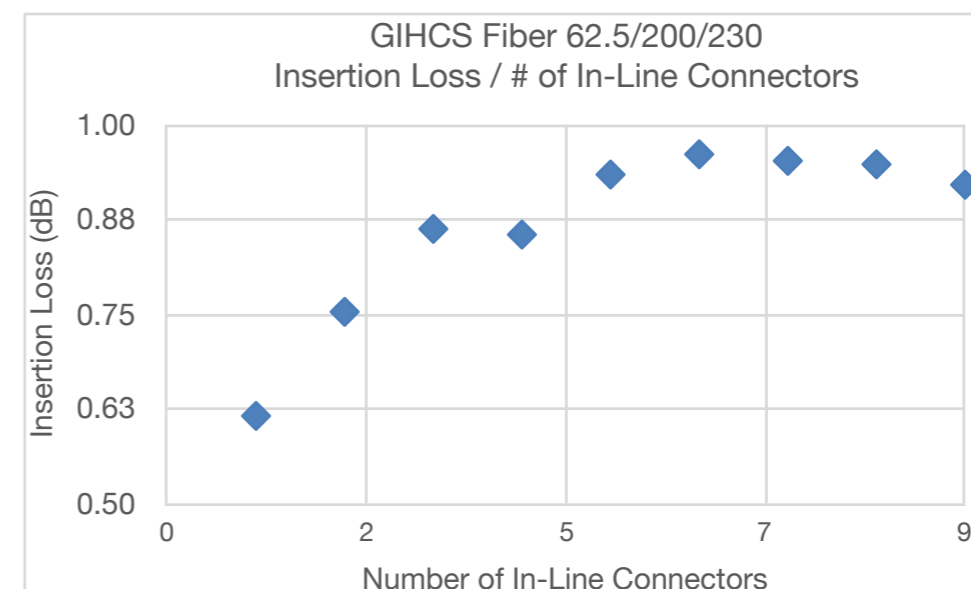

Technology Leveraging: Channel — GIHCS



- KDPOF characterization of Macro-bending IL
- Fiber under test: GIHCS 62.5/200/230 μ m:
 - Insertion loss per 90° turn < 0.012dB with curvature radius of 2mm
 - Insertion Loss per 8 complete turns < 0.35dB
 - Fiber recovers after test

Experimental Setup

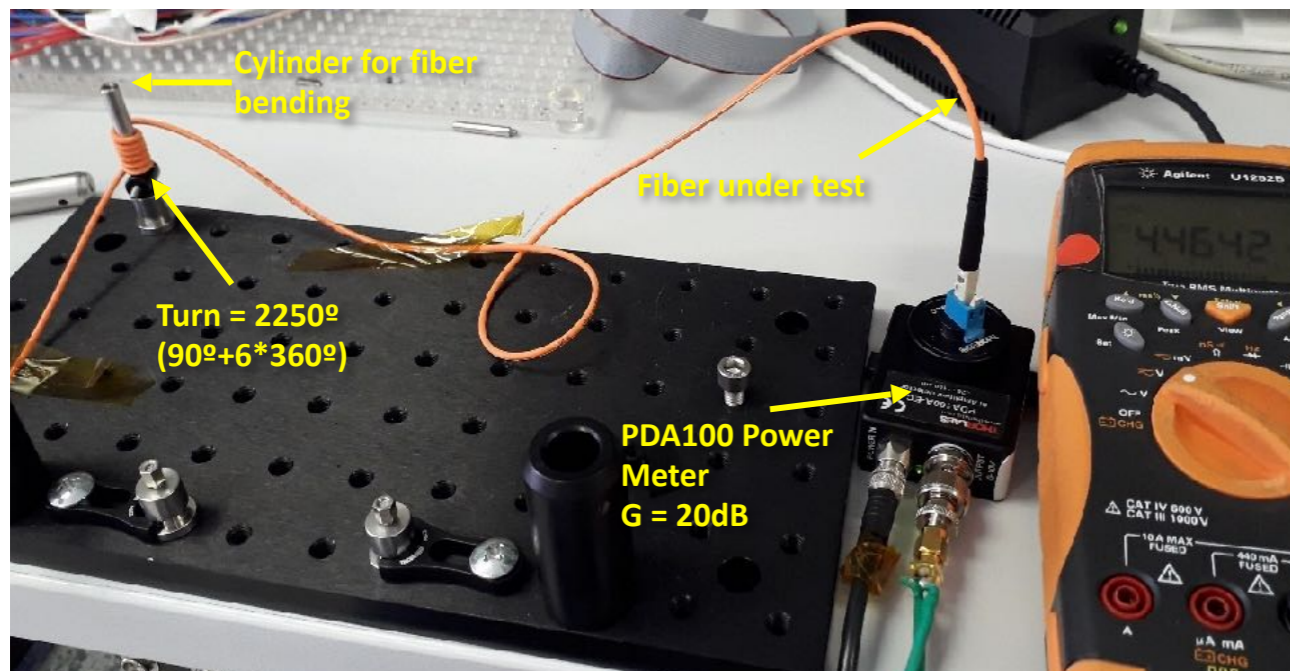

Results

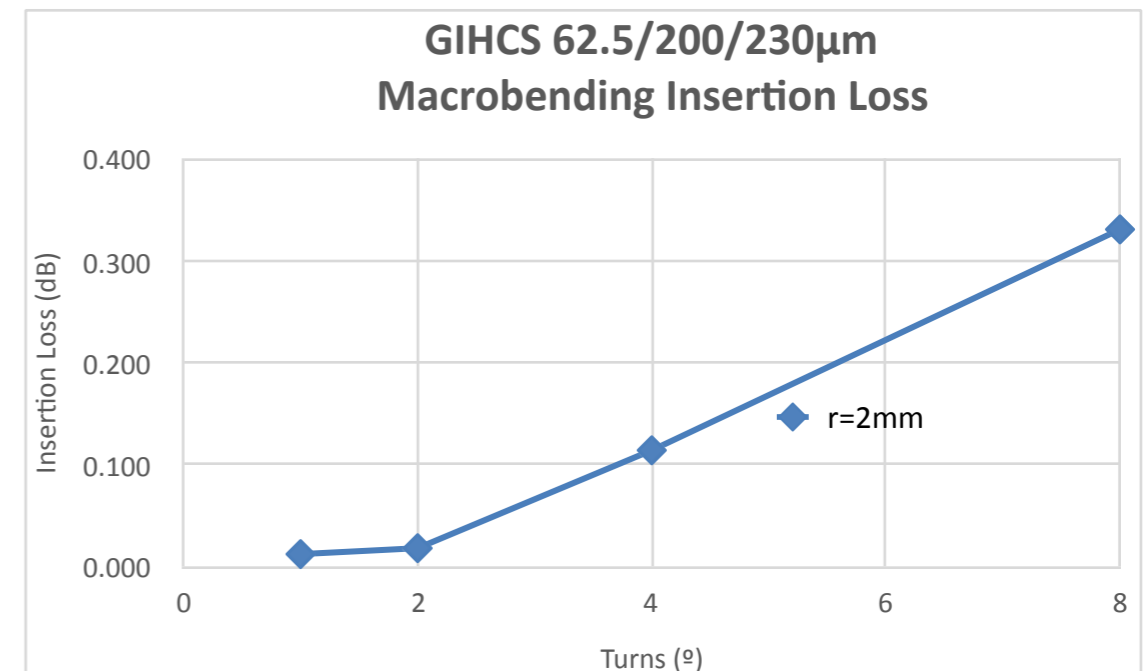

Technology Leveraging: Channel – GIHCS

- KDPOF characterization of Microbending IL

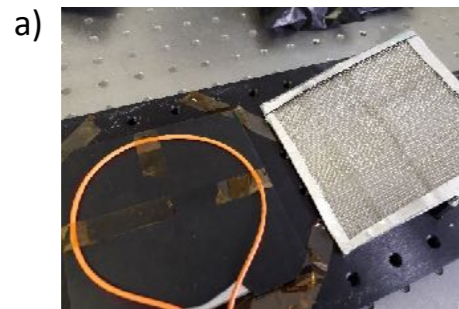

a) The fiber loop has 9 cm radius. And the fiber section that receives the pressure has a length of 25 cm.

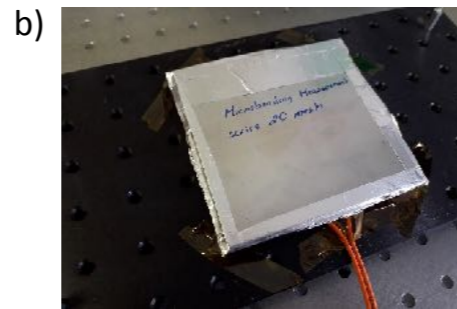

b) Meshes with grids of 60, 40 and 20 are used.

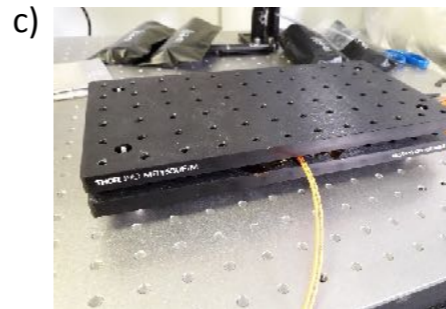

c) Aluminum and steel plates are used to distribute the load.

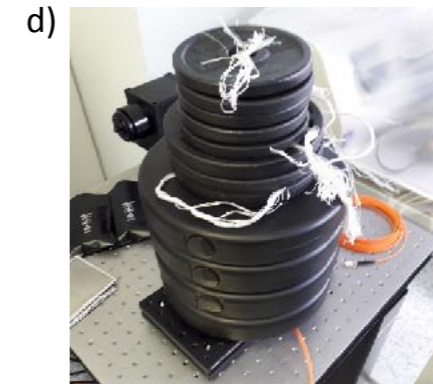

d) A total load of 36 Kg is applied.

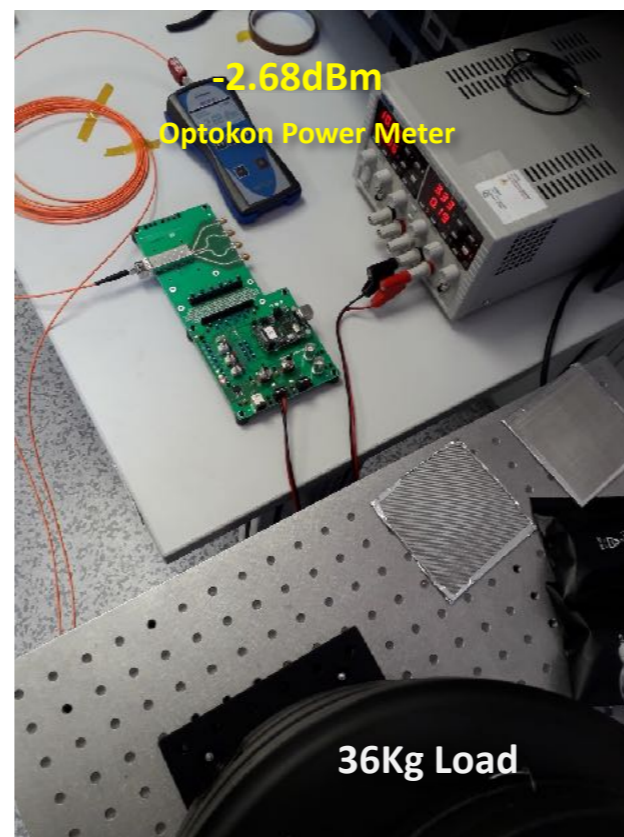
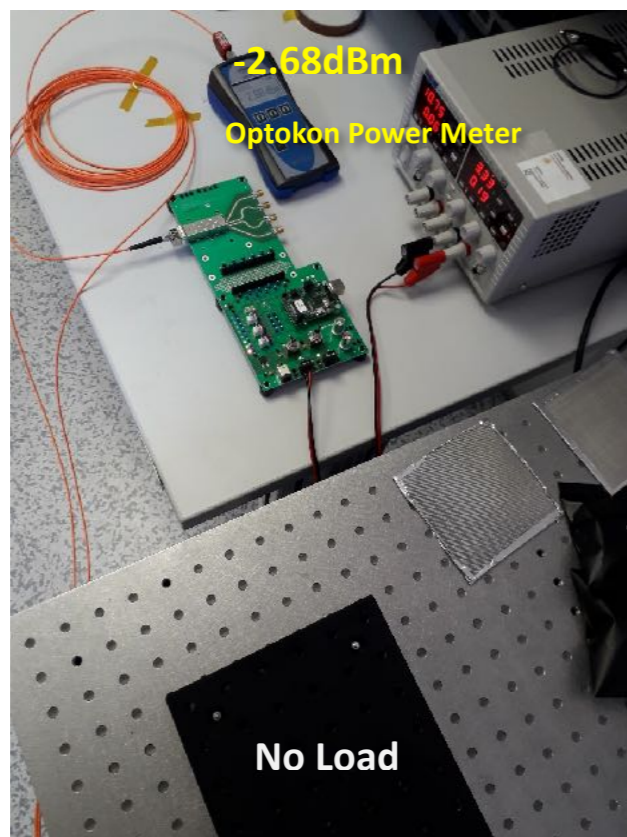

No variations were registered in the average optical power after applying a load of 36Kg.

Economic feasibility



- The photonics, electronics, and optics are going to have much bigger parametric variation than in the case of data-center products
 - Manufacturing process
 - Wider temperature range: T_j from $-40\text{ }^{\circ}\text{C}$ to $+125\text{ }^{\circ}\text{C}$
 - More important aging due to longer time in operation and temperature cycles
 - More aggressive mechanical and chemical loads
- Stringent reliability requirements will impose limits on which kind of electronics and components are suitable (e.g. VCSEL driving)
- Practices followed in data-centers products may not be longer valid:
 - Wafer-sort based binning to avoid large parametric variation
 - Use of special RF tech-nodes with low yield and integration (e.g. HBT)
- Adaptive technology will help drive economic feasibility:
 - Compensation of the channel response impairments caused by large parametric deviation
 - High production yield due to wider parametric variation is allowed
 - Sensitivity improvement to provide high link budget (higher insertion losses, higher tolerances, dust, aging, ...)
- Economic feasibility should be focused from a holistic point of view:
 - Photonics, electronics, cable harness, connector, optical connectivity, supply chain, ...



Key parameters for PHY technical feasibility

Key parameters for PHY technical feasibility: VCSEL



- $I_{TH} = f(A, T)$, being A the oxide aperture
- $AOP = f(A, T, I - I_{TH})$
- Intrinsic response: D-factor = $f(T)$, $Fr = f(A, T, \sqrt{I - I_{th}})$
- Intrinsic response: K-factor and Gamma-0, $\Gamma = f(A, T, Fr^2)$
- Extrinsic response (parasitic pole): $F_p = f(A, T, I - I_{th})$
- $RIN \times OMA_{MAX} = f(A, T, x)$, being x the max expected back reflection
- Reliability:
 - Max bias current to meet failures in time figure: $I_{BIAS,MAX} = f(A, T, FIT)$
 - Corner lots with max. current density should be considered (min oxide aperture)
- ER_{MIN} or OMA_{MIN} that the TX can have in worst case conditions
 - OMA shall be limited by design to avoid excessive non-linear dynamic distortion
 - Link-Budget shall be calculated in terms of OMA, while life-time is limited in current bias average
- Wavelength spectrum: $WL_C = f(A, T, I_{BIAS})$, $WL_W = f(A, T, I_{BIAS})$
- Rate-equations parameters identification as a function of T : non-linear time-domain response
 - Linear frequency response (i.e. Fr , Γ , Γ) allows for Shannon's capacity analysis
 - Non-linear time-domain response allows to determine implementation loss wrt. Shannon by transient simulation

Key parameters for PHY technical feasibility: Channel



- Fiber frequency magnitude response: $|H(f)| = f(\text{bending, } T, \text{ launching-condition, wavelength, cable length})$
 - Worst-case (min) bandwidth-length product for max considered length
- Fiber insertion loss: $IL_{\text{FIBER}} = f(\text{bending, } T, \text{ launching-condition, wavelength, cable length})$
 - Worst-case (max) insertion loss for max considered length
- Connections insertion loss:
 - VCSEL to TP2 IL_{MAX}
 - TP3 to PD IL_{MAX}
 - Inline connection IL_{MAX}
- Connections return loss:
 - RL_{MAX} for worst-case channel condition
 - Very important for RIN specification
- Connections losses considerations:
 - Fabrication tolerances, Aging, Dust
 - Humidity, Vibrations,
 - Mechanical, Size, and Economic feasibility

Key parameters for PHY technical feasibility: Others



- Photodiode:
 - Max capacitance $C_{PD} = f(T, V_R)$
 - Max series resistance R_S
 - Min responsivity R_{PD} (A/W) at VCSEL wavelength = $f(T)$
 - Min bandwidth (GHz), max transition time (ps) = $f(T, V_R)$
 - Max dark current = $f(T)$
- Trans-Impedance Amplifier:
 - Max input capacitance $C_{IN} = f(P, V, T)$, including pads, ESD protections, ...
 - Min input stage trans-conductance $g_{mIN} = f(P, V, T)$
 - Worst-case (min) GBW = $f(P, V, T)$ provided by the technology node
 - Max expected excess noise factor Gamma = $f(P, V, T)$ of technology node
- Clock:
 - Max expected PLL phase jitter, TX and RX sampling
 - Environment limitations? Is LC-tank valid for EMC automotive requirements?



Shannon's capacity based assessment

Reference model

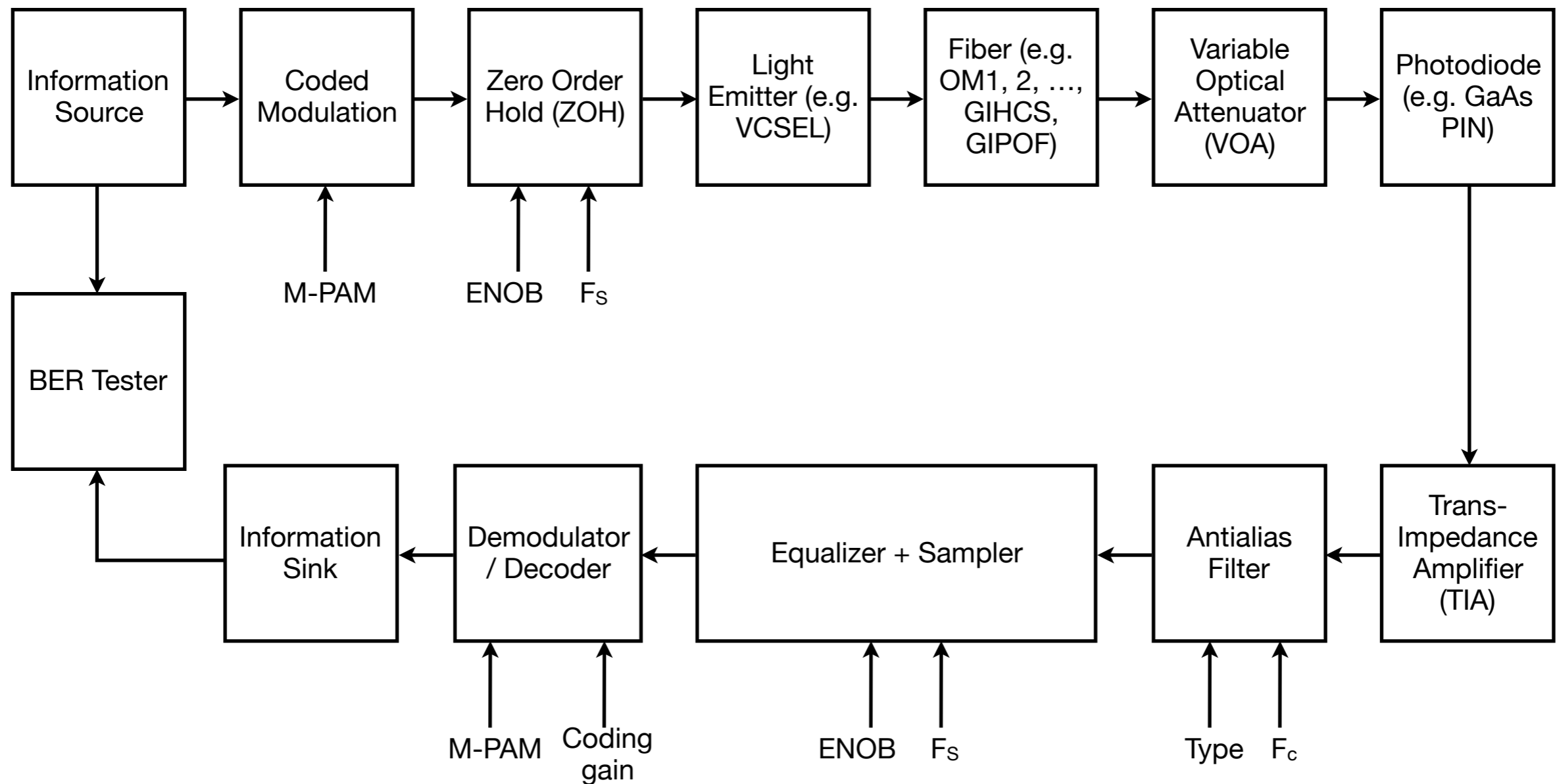

Information theory model

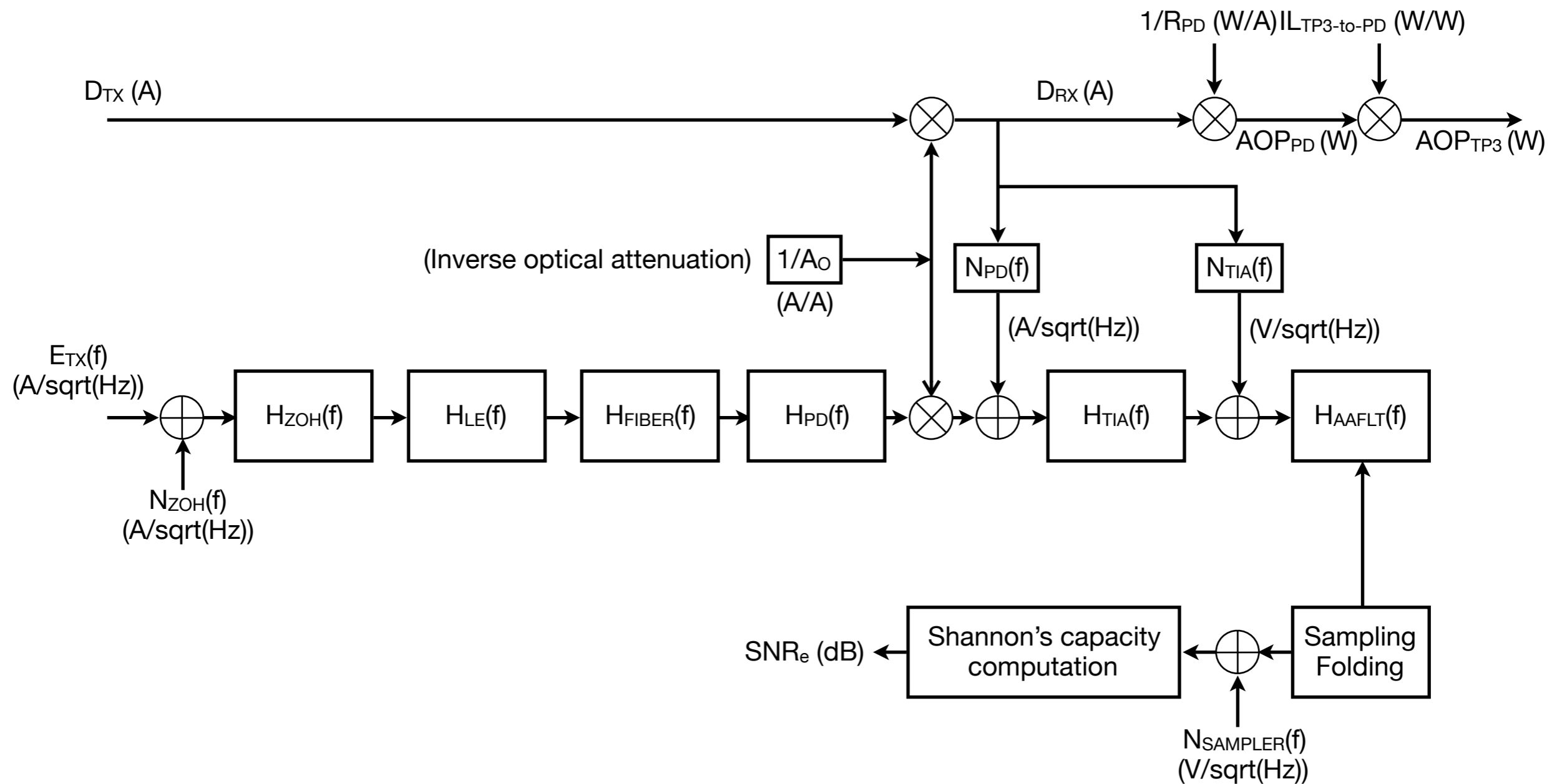

Information theory model

- Model built in the electrical domain (v.s. optical domain), because it is assumed an IM/DD optical communication system (like BASE-SR)
- Final sensitivity in terms of optical power in the photodiode and TP3 are derived by responsivity and optical coupling efficiency ($I_{L_{TP3-to-PD}}$)
- Two signal paths are considered, DC and AC, both closely related by the Extinction Ratio (ER) and the modulation scheme
- OMA figures can be calculated from AOP based on ER relation
- Transfer functions $H_{ZOH}(f)$, $H_{LE}(f)$, $H_{FIBER}(f)$, $H_{PD}(f)$ and $H_{AAFLT}(f)$ are normalized for DC gain of 0 dB
- Transfer function $H_{TIA}(f)$ preserves the trans-impedance conversion factor between input current and output voltage, therefore no DC gain normalized

Information theory model

- $E_{TX}(f)$: TX electrical current spectral density referred to photodiode output
- D_{TX} : average TX electrical current referred to photodiode output
- D_{RX} : average RX electrical current at the output of photodiode
- R_{PD} : Photodiode responsivity (A/W)
- $IL_{TP3-to-PD}$: insertion loss from TP3 to photodiode
- AOP_{PD} : average optical power coupled to photodiode
- AOP_{TP3} : average optical power at TP3
- A_O : variable optical attenuation
- $N_{ZOH}(f)$: ZOH noise spectral density in terms of electrical current referred to photodiode output
- $N_{SAMPLER}(f)$: Sampler noise spectral density in terms of electrical voltage
- $N_{PD}(f)$: photodiode shot noise spectral density as electrical current at the photodiode output
- $N_{TIA}(f)$: TIA output voltage noise spectral density
- $H_{ZOH}(f)$, $H_{LE}(f)$, $H_{FIBER}(f)$, $H_{PD}(f)$ and $H_{AAFLT}(f)$: transfer functions of ZOH, light emitter, fiber, photodiode and anti-alias filter, respectively
- $H_{TIA}(f)$: transfer function of the trans-impedance amplifier

Shannon's capacity method

- Let's define $N_{RX}(f)$ and $S_{RX}(f)$ as the spectral densities of noise and communication signal, respectively measured at the sampler output after folding. $N_{RX}(f)$ and $S_{RX}(f)$ are defined between DC and $F_s/2$
- Let's define the effective SNR (SNR_e) at the sampler output as the SNR that provides the same capacity of the channel defined by $S_{RX}(f)$ and $N_{RX}(f)$ in bandwidth $F_s/2$:

$$C = \frac{F_s}{2} \log_2(1 + SNR_e) \text{ bits/s}$$

$$SNR_e = \exp \left\{ \frac{2}{F_s} \int_0^{\frac{F_s}{2}} \ln \left(1 + \frac{S_{RX}(f)}{N_{RX}(f)} \right) df - 1 \right\}$$

- SNR_e is equal to the SNR_d in detector provided by an ideal infinite length unbiased MMSE DFE in an ISI channel
 - Error propagation is not considered
 - Degradation due to finite length filters constraint is not considered

Shannon's capacity method



- The minimum SNR_d required for M-PAM scheme can be well approximated by:

$$SNR_d = \frac{2}{3} \frac{M^{2C_R} - 1}{C_G} \left(\operatorname{erfc}^{-1} \left(\frac{M \log_2(M)}{M-1} P_b \right) \right)^2$$

where:

$$\operatorname{erfc}^{-1}(x) = \frac{2}{\sqrt{\pi}} \int_x^{\infty} e^{-t^2} dt$$

- AWGN is assumed in detector after noise whitening and ideal feedback by MMSE, u DFE
- Parameters:
 - M: number of levels of PAM scheme; $M \geq 2$
 - C_R : code-rate of FEC scheme; $C_R < 1$ for coded schemes, $C_R = 1$ for uncoded scheme
 - C_G : coding gain respect to an uncoded scheme; $C_G > 1$ for coded schemes, $C_G = 1$ for uncoded scheme. Coding gain is defined for a given P_b in non-asymptotic codes
 - P_b : bit error probability (i.e. BER) after demodulation and decoding

Shannon's capacity method

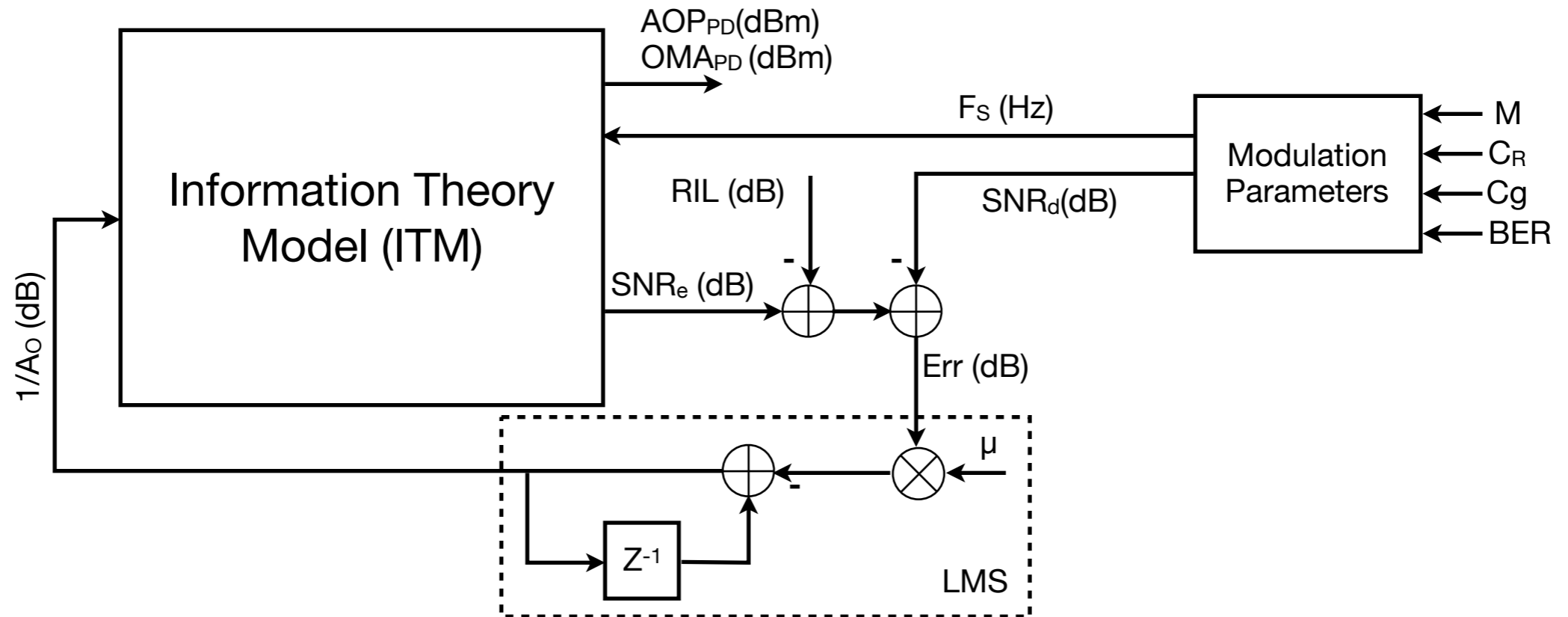

- The ITM is evaluated in several iterations in a LMS loop to find the minimum AOP_{PD} and OMA_{PD} (i.e. optical receiver sensitivity), for coded modulation scheme (F_s , M , C_R , C_G), and $Err < 0.01$ dB
- RIL (dB) is included to take into account the real PHY implementation losses, based on time-domain simulations where finite size circuits and non-linearities are considered
- OMA_{TP2} (dBm) = OMA_{LE} (dBm) - $IL_{LE-to-TP2}$ (dB)
- OMA_{TP3} (dBm) = OMA_{PD} (dBm) + $IL_{TP3-to-PD}$ (dB)
- Link budget LB (dB) = OMA_{TP2} (dBm) - OMA_{TP3} (dBm)
- Link margin LM (dB) = $LB - IL_{FIBER}$ (dB) - $N_{IC} \times IL_{IC}$ (dB) - IL_{BEND} (dB). If $LM \leq 0$ dB, the system is not feasible.



Thank you