

MARCH 3, 1977

**OPTICAL COMMUNICATIONS SCORING HIGH WITH U. S. ARMY/65**

Biggest field-erasable read-only memory makes its bow/108

How thin-film magnetic heads enhance data-storage systems/97

FOUR DOLLARS

A MCGRAW-HILL PUBLICATION

International

# Electronics®



## **SIGNATURE ANALYSIS**

**Tagging errors  
in the bit stream**

# HP quality, convenience and low prices mean big value in DMM's.

**\$225\*—The HP 3476A—3½ Digits—**Autoranging, automatic polarity and automatic zero make the 3476 a big value. It's a convenient size to hold in your hand or carry in your briefcase. Just \$225\* for the "A" version for AC line operation in your lab or \$275\* for the portable "B" version (with built in batteries and recharging circuit).

**\$375\*—The HP 970A—3½ Digits—**Handheld, autoranging, automatic polarity and zero, the 970 is totally self-contained and totally convenient. And the readout can be inverted with a flick of your thumb for easy reading. On the job measurement has never been easier.

**\$400\*—The HP 3435A—3½ Digits—**Autoranging or manual operation and wide-range operation, plus built-in batteries and recharging circuits bring you laboratory

accuracies and portability in the same unit. If you don't need battery operation, option 001 gives you line operation only for just \$335\*.

**\$500\*—The HP 3465B—4½ Digits—**1  $\mu$ V sensitivity gives you performance you'd normally expect from a 5½-digit multimeter. Fully portable too, with its own nickel-cadmium batteries and recharging circuit. Dry-cell operation and a rack-mount version are available in the 3465A for as low as \$425\*.

**Confidence** in low-cost DMM's comes from knowing you've made the right decision. HP's quality and service give you assurance. Contact your local HP field sales engineer or write today for more information.

\*Domestic U.S.A. price only.

**HP DMM's...  
the right decision.**

097/42



Circle 900 on reader service card

**HEWLETT *hp* PACKARD**

1507 Page Mill Road, Palo Alto, California 94304

For assistance call: Washington (301) 948-6370, Chicago (312) 255-9800, Atlanta (404) 955-1500, Los Angeles (213) 877-1282

World Radio History

# SURPRISE!



## Our New Display Can Say A Lot For You

Our new HDSP-2000 Alphanumeric Display can spell it out for you in bright, crisp LED characters. The full 5x7 dot matrix can display ASCII or custom character sets including lower case and symbols.

Compact and complete with on-board electronics, the HDSP-2000 dramatically reduces display system size and complexity. Each 12 pin DIP contains 4 characters with row drivers and storage. End stackable and easy to interface, they're ideal for "smart" instruments, medical systems or business terminals, military applications, and almost any mobile, portable or hand-held device.

The price is \$47.00\* per 4-character cluster in quantities of 125 clusters. They're in stock today at HP's franchised distributors. In the U.S. contact Hall-Mark, Schweber, Wilshire or the Wyle Distribution Group (Liberty/Elmar) for immediate delivery. In Canada, contact Zentronics, Ltd. \*U.S. Domestic price only.

**HEWLETT  PACKARD**

Sales and service from 172 offices in 65 countries.  
1507 Page Mill Road, Palo Alto, California 94304

# LOOK:

**High-Sensitivity 70 dB Swept Scalar Measurements, Free From Source Harmonics, And Surprisingly Cost-Effective.**

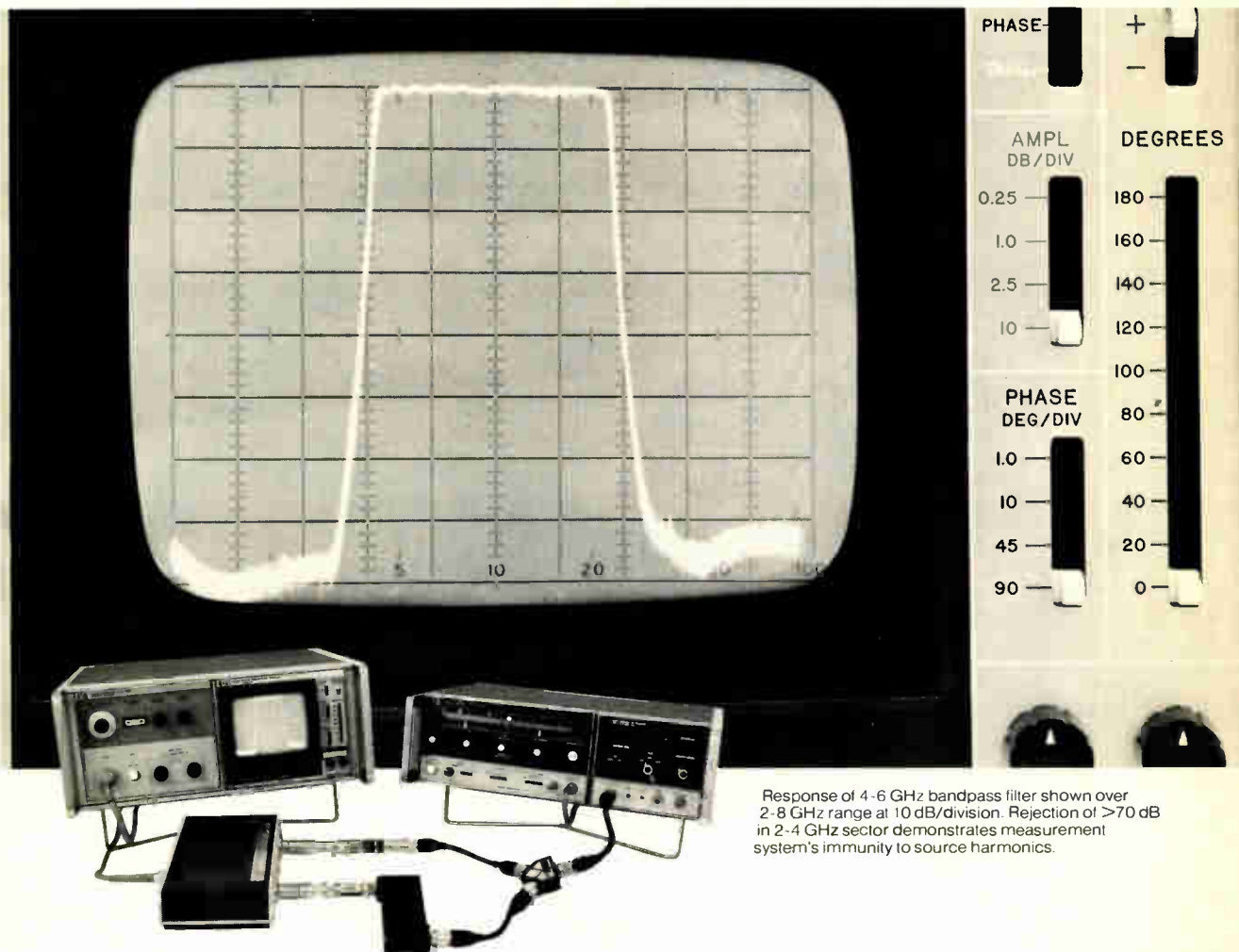

Response of 4-6 GHz bandpass filter shown over 2-8 GHz range at 10 dB/division. Rejection of >70 dB in 2-4 GHz sector demonstrates measurement system's immunity to source harmonics.

The HP 8410B Network Analyzer, widely known for its vector measurement capabilities, can also be configured for scalar (magnitude-only) measurements. Its immunity to harmonics and its  $-78$  dBm sensitivity give it as much as 30 dB more range than typical broadband diode detection systems.

When you assemble a complete broadband (100 MHz-18 GHz) testing system (8410B Analyzer plus swept sources), the extra dynamic range and high sensitivity of this scalar system cost only about 19% more than an equivalent diode detector-based system. For the analysis portion of the system, you only need the 8410B Analyzer, 8411A Converter and 8412A Display which cost \$9050. Domestic U.S. prices only.

These instruments can, of course, also be the nucleus of your *vector* measurement system. For complete phase-magnitude characterization of microwave devices and circuits, just add the appropriate reflection/transmission test sets.

A candid discussion of scalar measurement alternatives and trade-offs is found in Application Note 187-3. For your copy plus information about these precision instruments, just contact your HP field engineer, or write.

**HEWLETT  PACKARD**

Sales and service from 172 offices in 65 countries.  
1507 Page Mill Road, Palo Alto, California 94304

## 31 Electronics Review

PERIPHERALS: Small printer duplicates CRT screen in a second, 31  
MEMORIES: Intel, AMI promise under 50-ns MOS memories, 32  
COMMERCIAL: Consumers balk at funds-transfer services, 33  
MICROPROCESSORS: TI, Motorola pare down for low end, 34  
PACKAGING & PRODUCTION: Rails, wedges keep pc cards cool, 36  
COMMUNICATIONS: 900-MHz system planned by common carrier, 38  
COMPONENTS: TI readies 50¢ temperature sensor, 38  
NEWS BRIEFS: 40  
AUTOMOTIVE: Ford plans for vendors beyond 1978 unclear, 40

## 53 Electronics International

GREAT BRITAIN: Company kindles glow in auto-instrument panels, 3E  
JAPAN: Electrostatic printer deposits two colors, 3E  
GREAT BRITAIN: Two firms ready Teletext decoders, 4E  
WEST GERMANY: Linear accelerators irradiate large body areas, 6E  
FRANCE: Stereo decoder eliminates interference by harmonics, 8E  
NEW PRODUCTS INTERNATIONAL: 13E

## 65 Probing the News

COMMUNICATIONS: Army speeds fiber-optic work, 65  
Aiming satellite TV at rooftops, 69  
SPACE ELECTRONICS: Europe sets direction in space, 72  
COMPUTERS: Encryption standard nears reality, 74  
ELECTRONICS ABROAD: Chinese push semiconductor work, 78

## 89 Technical Articles

MICROPROCESSORS: Hexadecimal signatures spot digital trouble, 89  
COMPUTERS: Thin-film magnetic heads excel in data recording, 97  
DESIGNER'S CASEBOOK: Calibrator needs no precision parts, 104  
Inductive kick gates SCR motor crowbar, 105  
Comparator switches regulator for foldback current limiting, 105  
SOLID STATE: Biggest erasable PROM contains 16,384 bits, 108  
COMPONENTS: Hybrid transformers prove versatile up to 1 MHz, 113  
ENGINEER'S NOTEBOOK: Op amp has low thermal coefficient, 116  
Logic tester has unambiguous display, 117  
Chart aids selection of optimum LED driver, 117

## 124 New Products

IN THE SPOTLIGHT: 4-k static RAM uses dynamic features, 124  
Multipoint recorders get a face lift and C-MOS logic, 128  
COMPONENTS: Solid-state relays overcome big weaknesses, 130  
MATERIALS: Magnetic shield can be shaped, 138  
SUBASSEMBLIES: A-d converters miss no codes, 145  
MICROPROCESSORS: Data-acquisition board fits Intel computers, 150  
DATA HANDLING: Array-signal processor fits on plug-in board, 159  
PACKAGING & PRODUCTION: Bonder puts chips on strips, 165

## Departments

Publisher's letter, 4  
Readers' comments, 6  
News update, 8  
Editorial, 12  
People, 14  
Meetings, 20  
Electronics newsletter, 25  
Washington newsletter, 49  
Washington commentary, 50  
International newsletter, 55  
Engineer's newsletter, 120  
New literature, 173

## Services

Reader service card, 17E  
Employment opportunities, 174  
Reprints available, 183

## Highlights

### Cover: Signature analysis spots system faults, 89

Servicing a microprocessor-based product at the component level can be more economical than replacing modules—if the product is designed to meet the requirements of signature analysis. Based on the technique of signal tracing, the process translates bit streams into hexadecimal "signatures" for comparison with the correct signatures on the circuit diagram.

Cover is by designer Ann Dalton

### Standard code to protect computer secrets, 74

Theft of secrets entrusted to computers and compromises of the data they hold are two electronic nightmares that will dwindle now that the National Bureau of Standards has adopted a data encryption standard for government and industry use. Add-on equipment incorporating the standard will encode data transmissions and will prevent unauthorized access.

### Thin-film heads boost data recording, 97

A new generation of computer disk and tape drives with higher data-transfer rates and more storage at lower costs per bit is the promise of thin-film magnetic read/write heads. Now entering the marketplace, the heads combine vacuum-deposited thin-film sensors with traditional housings.

### Erasable PROM packs 16,384 bits, 108

Read-only memories that are erasable and programmable are finding a niche in production equipment as well as in the development cycle. Helping the trend along is a 16,384-bit ultraviolet-erasable PROM that is faster and easier to use than its smaller cousins.

### And in the next issue . . .

A special report on packaging integrated circuits . . . using the SR-52 to plot graphs . . . the art of becoming a successful consultant.

EDITOR-IN-CHIEF: Kemp Anderson

EXECUTIVE EDITOR: Samuel Weber

MANAGING EDITOR: Arthur Erikson,  
*International*

SENIOR EDITORS: Laurence Altman,  
Ray Connolly, Lawrence Curran,  
John Johnsrud, H. Thomas Maguire,  
Stephen E. Scrupski, Gerald M. Walker

ART DIRECTOR: Fred Sklenar

ASSOCIATE EDITORS: Howard Wolff,  
Alfred Rosenblatt

#### DEPARTMENT EDITORS

*Aerospace/Military*: Ray Connolly  
*Circuit Design*: Raymond P. Capece  
*Communications & Microwave*:  
Richard Gundlach

*Components*: Lucinda Mattered  
*Consumer*: Gerald M. Walker  
*Industrial*: Raymond P. Capece  
*Instrumentation*: Stephen E. Scrupski  
*New Products*: H. Thomas Maguire,  
Michael J. Riezenman

*Packaging & Production*: Jerry Lyman  
*Solid State*: Laurence Altman

CHIEF COPY EDITOR: Margaret Eastman

COPY EDITORS: Everett C. Terry, Ben Mason

ART: Charles D. Ciatto, *Associate Director*  
Paula Piazza, *Assistant Director*

EDITORIAL SECRETARIES: Janet Noto,  
Penny Rothman, Marilyn B. Rosoff

#### FIELD EDITORS

*Boston*: Lawrence Curran (Mgr.), Pamela Leven

*Los Angeles*: Larry Waller (Mgr.)

*Midwest*: Larry Armstrong (Mgr.)

*New York*: Bruce LeBoss (Mgr.)

*San Francisco*: Bernard Cole (Mgr.)

Judith Curtis

*Washington*: Ray Connolly (Mgr.)

*Frankfurt*: John Gosch

*London*: William F. Arnold

*Paris*: Arthur Erikson

*Tokyo*: Charles Cohen

McGRAW-HILL WORLD NEWS

*Editor*: Michael Johnson

*Brussels*: James Smith

*Milan*: Andrew Heath

*Moscow*: Peter Gall

*Paris*: Joel Stratte-McClure

*Stockholm*: Robert Skole

*Tokyo*: Colin Gibson

PUBLISHER: Dan McMillan

ADVERTISING SALES MANAGER:

Paul W. Reiss

MARKETING ADMINISTRATION MANAGER:

Wallis Clarke

CIRCULATION MANAGER: Karl Peterson

MARKETING SERVICES MANAGER:

Tomlinson Howland

RESEARCH MANAGER: Margery D. Sholes

As the changes wrought by the microprocessor ripple through all parts of the electronics industries, increasing attention is going to have to be given to troubleshooting and repairing the proliferating microprocessor-based products. The article on page 89—"Hexadecimal signatures help identify troublespots in microprocessor systems"—represents a major commitment to a new troubleshooting approach by industry giant Hewlett-Packard Co.

Author Gary Gordon says the idea presented in the article grew out of a desire to do for digital products what such troubleshooting aids as Sams Photofacts, annotated schematics showing waveforms and voltage levels, did for analog circuits and those who had to troubleshoot them.

"The analog world has a lot in common with the game of horse-shoes—being close counts—but the digital world is unforgiving. One bad bit out of a thousand can cause a malfunction," he notes. The technique of signature analysis finds those bad bits.

One HP engineer, he says, summed it up by observing, "We may just be sitting on the next volt"—a new unit of measure. Whereas logic probes simply detect digital activity, the signature analyzer quantizes it into a four-digit hexadecimal number. And such numbers can be listed on schematics just the way voltages are listed on analog-circuit schematics. Gordon figures that the approach, being the generator of a new unit of measure will generate a name to go with it. He adds that Hancock, a famous name in signatures, would be a good one.

Gordon liked the simplicity of the old-standby annotated-schematic approach and it "stuck in our minds for many years, but reducing the idea to practice proved to be very elusive." The first development was in HP's Colorado Springs division, where the use of a feedback shift register was found to be the best available way to derive a signature. HP's Loveland Instruments division contributed significantly by working out guidelines for writing the necessary stimulus routines.

First used in the HP's 3455A digital voltmeter, the technique of signature analysis now is being designed into practically all of HP's new microprocessor-based products. "About a year ago we offered 30 signature analyzers to other divisions," Gordon adds. "There now are about 40 projects under way, with some products already entering the marketplace."

He shares billing on the patent for signature analysis with development engineers Dan Kolody, George Haag, and Jan Hofland. Co-author Hans Nadig primarily worked on development of the instrument that derives the signatures, the 5004A signature analyzer, along with engineers Tony Chan and Bob Frohwerk, while Fred Coury provided a great deal of insight as a consultant on the problem of designing the technique into new products.



March 3, 1977 Volume 50, Number 5 94,063 copies of this issue printed

Published every other Thursday by McGraw-Hill, Inc. Founder: James H. McGraw 1860-1948. Publication office 1221 Avenue of the Americas, N.Y., N.Y. 10020; second class postage paid at New York, N.Y. and additional mailing offices.

Executive, editorial, circulation and advertising addresses: Electronics, McGraw-Hill Building, 1221 Avenue of the Americas, New York, N.Y. 10020. Telephone (212) 997-1221. Teletype 12-7360 TWX 710-581-4879. Cable address: MCGRAW HILL N E W Y O R K.

Subscriptions limited to professional persons with active responsibility in electronics technology. No subscriptions accepted without complete identification of subscriber name, title or job function, company or organization, and product manufactured or services performed. Based on information supplied, the publisher reserves the right to reject non-qualified requests. Subscription rates: in the United States and possessions \$14.00 one year, \$35.00 three years; company addressed and company libraries \$20.00 one year, \$50.00 three years; APO/FPO addressed \$35.00 one year only; Canada and Mexico \$16.00 one year, \$40.00 three years; Europe \$40.00 one year, \$100.00 three years; Japan, Israel and Brazil \$65.00 one year, \$165 three years; Australia and New Zealand \$90.00 one year, \$240 three years, including air freight; all other countries \$45.00 one year, \$112.00 three years. Limited quota of subscriptions available at higher-than-basic rate for persons allied to field served. Check with publisher for these rates. Single copies: \$4.00. Please allow four to eight weeks for shipment.

Officers of McGraw-Hill Publications Company: Gordon L. Jones, President; Paul F. McPherson, Executive Vice-President; Group Vice-President, Gene W. Simpson; Senior Vice-Presidents: John B. Hoglund, Controller; David G. Jensen, Manufacturing; Ralph R. Schuit, Editorial Vice-Presidents: James E. Boddorf, Planning & Development; Robert L. Leyburn, Circulation; Edward E. Schirmer, Sales.

Officers of the Corporation: Harold W. McGraw, Jr., President, Chief Executive Officer, and Chairman of the Board; Robert N. Landes, Senior Vice President and Secretary; Ralph J. Webb, Treasurer.

Title registered in U.S. Patent Office; Copyright © 1977 by McGraw-Hill, Inc. All rights reserved. The contents of this publication may not be reproduced in whole or in part without the consent of copyright owner.

Subscribers: The publisher, upon written request to our New York office from any subscriber, agrees to refund that part of the subscription price applying to copies not yet mailed. Please send change-of-address notices or complaints to Fulfillment Manager; subscription orders to Circulation Manager, Electronics, at address below. Change-of-address notices should provide old as well as new address, including postal zip code number. If possible, attach address label from recent issue. Allow one month for change to become effective.

Postmaster: Please send form 3579 to Fulfillment Manager, Electronics, P.O. Box 430, Hightstown, N.J. 08520.

From DC to 1 megahertz, the Model 7500 direct coupled amplifier puts up to 75 watts and 125 VRMS at your fingertips. This **all** solid state unit offers typical frequency response of  $\pm .05\text{db}$  and harmonic distortion of .05%. Output circuit is both current and voltage protected. Voltage gain is 0 to X100, fixed or variable. Both AC and DC input coupling are provided. Ideal for precision meter calibration and transducer driving. Stick with the WAVEMAKERS.™ Contact any of the reps listed.

**KH KROHN-HITE CORPORATION**

Avon Industrial Park, Avon, Mass. 02322 • (617) 580-1660

OVERSEAS SALES OFFICES: ARGENTINA: COASIN S/A / AUSTRIA: UNIVERSAL ELEKTRONIK IMPORT / AUSTRALIA: WARBURTON FRANKI LIMITED / BELGIUM: C N ROOD S A / CANADA: CANADIAN MARCONI COMPANY / DENMARK: SC METRIC A/S / ENGLAND: KEITHLEY INSTRUMENTS. LTD / FINLAND: INTO/OY / FRANCE: MB ELECTRONIQUE / GERMANY: NUCLETRON VERTRIEBS GMBH / HOLLAND: C N. ROOD B V / INDIA: BALI INTERNATIONAL AGENCIES / ISRAEL: R O T ELECTRONICS ENGINEERING LTD / ITALY: VIANELLO S P A / JAPAN: CHISHO CORP / NEW ZEALAND: WARBURTON FRANKI. LTD / NORWAY: TELEINSTRUMENT AB / PORTUGAL: MAGNETROM / SINGAPORE: O'CONNORS (PTE). LTD / SOUTH AFRICA: PROTEA PHYSICAL & NUCLEAR INST (PTY) LTD / SPAIN: REMA LEO HAAG. S A / SWEDEN: TELEINSTRUMENT AB / SWITZERLAND: MEGEX ELECTRONIC AG

See Us At Booth #1423-1425

**Electro77**

# the 7500 amplifier... WIDEBAND-AID for system designers

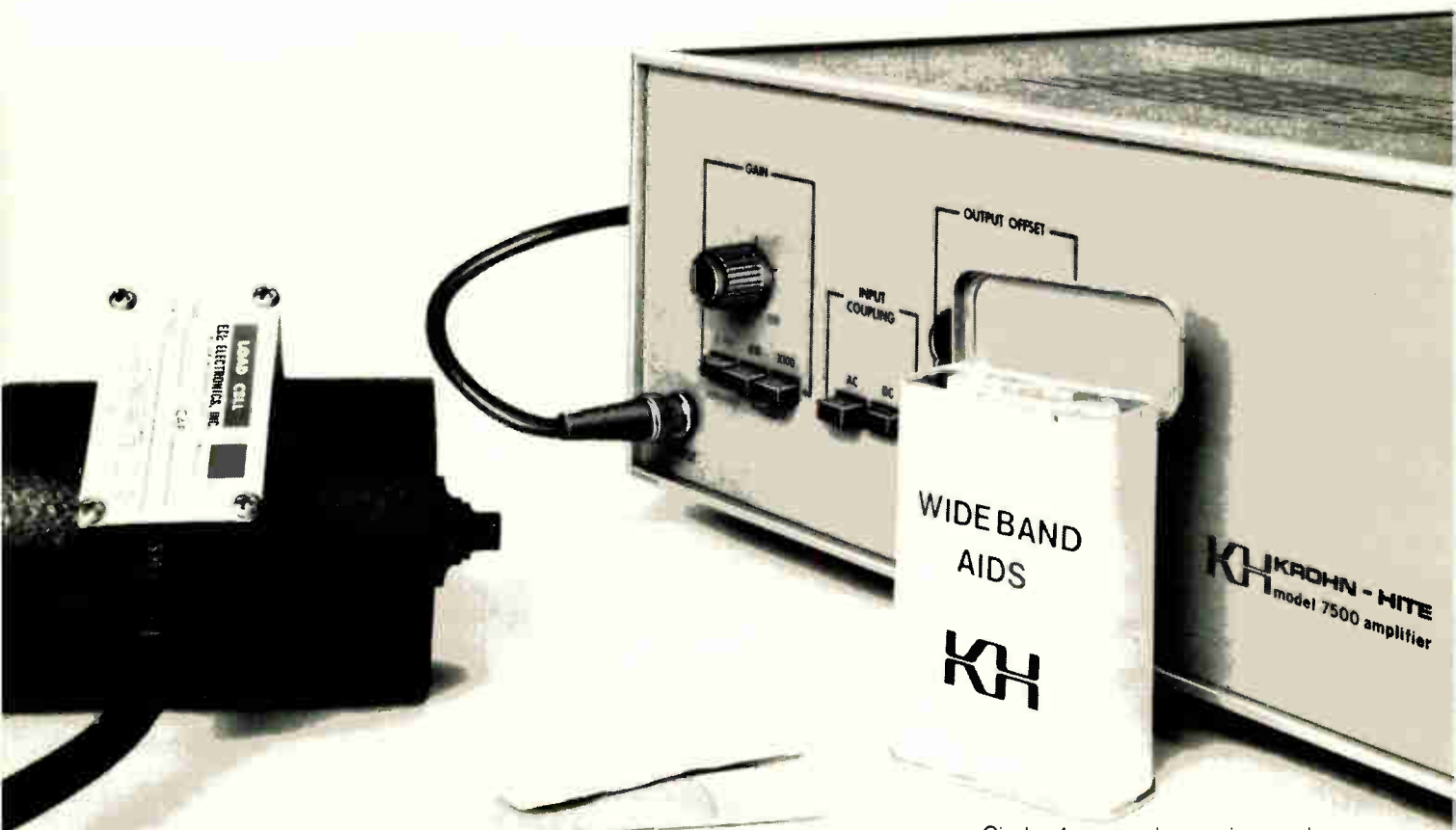

Circle 4 on reader service card

## Readers' comments

### More light on fluorescents

**To the Editor:** I certainly hope Mr. Soanes doesn't think the light of a fluorescent lamp comes (mostly) from its filaments [p. 6, Dec. 9]. Actually, I'd be willing to bet that the thermal time constant of the filaments in any type of fluorescent lamp (preheat, rapid-start, etc.) is longer than that of a typical incandescent lamp.

The pertinent parameters, I'd say, are the light-output-vs-time curve of the ionized gas inside the lamp and the decay time of the phosphor. Actually, the phosphor's spectrum seems to shift radically at twice the line frequency. It would be instructive to observe a fluorescent light through a phasable, "line-synchronized" optical chopper.

There is a special class of incandescent lamps that has a filament structure with a short thermal time constant. It might be quite practical to send Morse code with these lamps, although they may not have been used for that. See, for instance, the GE 4300, 4500, 4520, etc., which are probably in this category.

Another point that may be pertinent is the effect of constant-voltage vs constant-current operation on the apparent thermal time constant of an incandescent filament. I think the preheat type of fluorescent lamp is started in constant-current mode, which might make it seem that its filaments have a longer thermal time constant than they would with constant-voltage operation.

Nicholas Bodley  
New York, N.Y.

### Another 7-segment-to-BCD-er

**To the Editor:** I thought other readers might be interested in knowing that Scarpa Laboratories Inc., Metuchen, N.J., also makes a seven-segment-to-binary-coded-decimal converter [Dec. 3, p. 116]. It is the SC-427, which is made with transistor-transistor-logic-Schottky technology. Tom Scarpa indicates that it also contains a programmed read-only memory.

Neil A. Benson  
Northwest Computer Services Inc.  
Minneapolis, Minn.

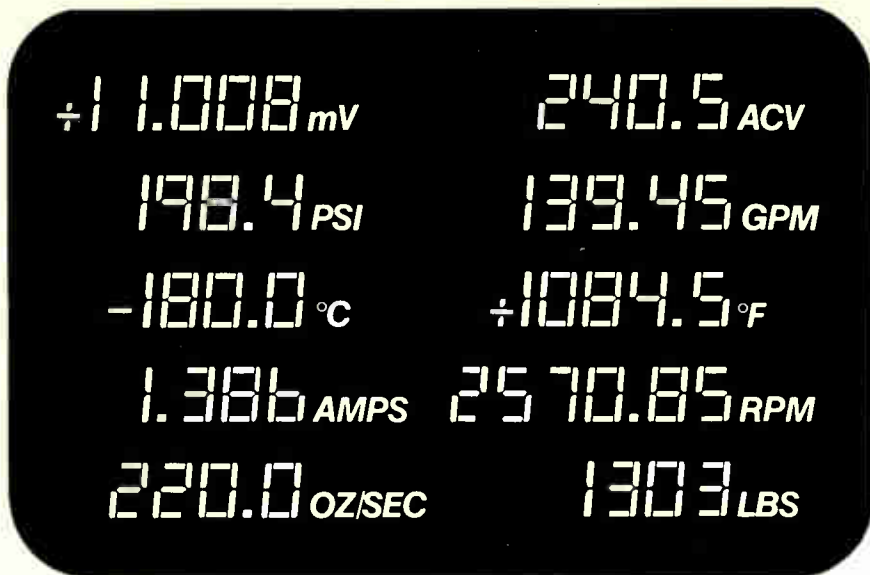

# United Systems' Indicators Will:

- MEASURE voltage and current; ac, true rms or dc.
- CONVERT the output of any transducer/transmitter to display in engineering units.
- DISPLAY temperature (C or F) directly from thermocouple, RTD, or thermistor sensors.
- INTERFACE readily into your system by optional "single line enable" parallel BCD output.
- INDICATE when a predetermined limit is exceeded, through relay closure or logic level output from optional internal comparator alarm.

And with United Systems' exclusive adaptors these indicators change, in the field, to perform any measurement listed above and more!

For additional information contact your United Systems Representative or call the factory (513) 254-6251.



**DigiTec.** UNITED SYSTEMS CORPORATION

918 Woodley Road Dayton, Ohio 45403  
(513) 254-6251 TWX (810) 459-1728

United Systems Corp. Precision measurements to count on

LHC "Information only" circle 6

RHC "Demonstration only" circle 72



New compensated op amp...

# BiMOS scores again. Low $V_{IO}$ , low drift, at a low price.

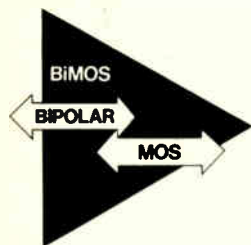

The RCA CA3160: latest proof that BiMOS is today's op amp technology. It has the lowest drift ever available in a low price general purpose op amp:  $6 \mu\text{V}/^\circ\text{C}$ .

Low enough for 95% of all op amp applications. It has  $V_{IO}$  of only 2 mV typical (CA3160A). Ultra-low input current: 2 pA typical. And on-chip compensation.

All this is on top of the other features that have made BiMOS op amps so universally applicable.

Features like very high input impedance:  $1.5 \text{ T}\Omega$ . Rail-to-rail voltage swing. High common-mode

capability: the CA3160 can differentially follow input signals ranging from 3.0 V below the positive supply voltage down to 0.5 V below the negative supply rail. Which can eliminate the need for a dual  $\pm$  supply.

Yet the remarkable CA3160 costs a lot less than performance-competitive op amps. Thanks to RCA experience. And the inherently simple manufacturability of BiMOS.

Get the op amp with premium characteristics without paying a premium price. Contact your RCA Solid State distributor.

Or RCA.

Write: RCA Solid State, Box 3200 Somerville, NJ 08876; Sunbury-on-Thames, Middlesex TW16 7HW, England; Ste.-Anne-de-Bellevue, Quebec, Canada; Fuji Bldg., Tokyo, Japan.

**RCA Linear IC experience is working for you**

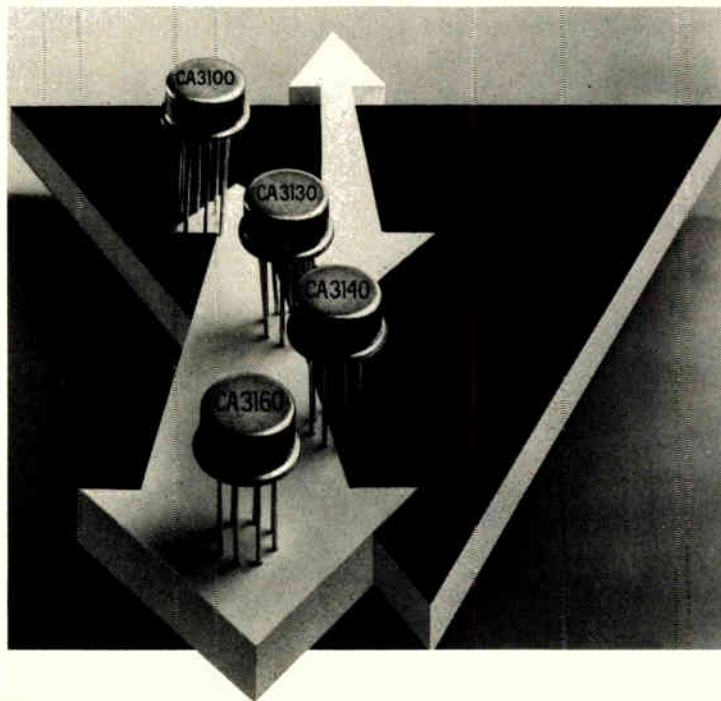

# RCA

# THE NEW BIBLE

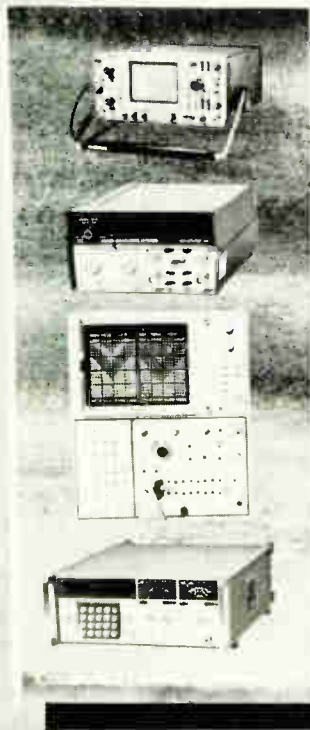

CONTINENTAL  
1977  
ELECTRONIC  
INSTRUMENT  
RENTAL  
CATALOG

Rentals Lease Sales Service

## For test instrument users.

Continental's 1977 rental catalog lets you compare *detailed* specs and prices on more than 500 instruments from 90 manufacturers! No other source offers this much information on this many products! And they're conveniently grouped by categories you understand.

See Us At Booth #1736

Call  **Electro77**  
**Continental**  
**Rentals**

Div. Continental Leasing Co., Inc.  
175 Middlesex Turnpike, Bedford, MA 01730  
(617) 275-0850

FOR IMMEDIATE RESPONSE CALL:  
N.E. (617) 275-0850; L.I. (516) 752-1622;  
NY, NJ (201) 654-6900; Gtr. Phila. (609) 234-5100;  
Wash., D.C. area (301) 948-4310;  
Mid West (312) 439-4700;  
So. Central (214) 690-1706;  
Costa Mesa, CA (714) 540-6566;  
L.A., CA (213) 477-7521;  
Santa Clara, CA (408) 735-8300.

Circle 8 on reader service card  
World Radio History

## News update

■ Standard Microsystems Corp. of Hauppauge, N.Y., has delivered qualification prototypes of its n-channel MOS chips with the new synchronous data-link control (SDLC) protocol functions to Digital Equipment Corp. in Maynard, Mass. Standard is also making samples of the chip available to industry. At the same time, Signetics Corp. of Sunnyvale, Calif., is promising deliveries to DEC of its qualification prototype later this month, which is when both chip suppliers say they will have volume quantities of the SDLC devices available commercially.

The minicomputer company worked with both device manufacturers in developing the SDLC chips in return for guaranteed production orders [*Electronics*, Aug. 7, 1975, p. 76]. DEC doesn't plan to use the chips in production quantities, however, "until the next fiscal year," which begins July 1, says Vince Bastiani of DEC's PDP-11 communications engineering department. DEC presently supplies as an option a DUP-11 signal line interface board that provides the SDLC capability for the PDP-11 family of computers. "But that's a very dense printed-circuit board with about 110 integrated circuits on it. Using these [SDLC] chips," Bastiani continues, "can reduce the size significantly."

Standard's COM5025, which will cost \$94 each for 1 to 24 pieces and \$72.70 in lots of 100 to 999, and Signetics' 2652 will have some unique features in addition to meeting the DEC specs. The Standard unit will have a control field that can be extended to 2 bytes and an address field extendable to almost any length, while the Signetics device will have one address byte and one control byte. In the non-SDLC mode, the 2652 can handle either 7 bits plus a parity bit or 8 bits and no parity, whereas the COM5025 can handle 8 bits of data plus a parity bit. Also, the Standard chip can handle an all-parties address mode for global addressing. The Signetics device has a "chip select" feature that, when activated, provides compatibility to any 8-bit microcomputer system.

**Bruce LeBoss**

**Electronics** / March 3, 1977

# The Producer.



## *Now you get expanded in-circuit digital test capability with the production-proven FF101C in-circuit test system for printed circuit boards.*

Your test system has to produce. It must have the flexibility to keep pace with the variety of analog, digital and hybrid boards you're testing now and to meet your future needs. The Faultfinder® FF101C in-circuit test system gives you that flexibility with capabilities like these:

- Automatic in-circuit program generation.
- Digital device library.
- High-level truth table programming.
- Full TTL, DTL, RTL and CMOS test capability.
- Programmable clock and reset lines.
- Programmable logic levels.
- Data logging and failure analysis.

Add to these features complete analog testing capability and the ability to expand peripheral equipment and you have the in-circuit test system you need to deliver cost-efficient, production rate testing of your printed-circuit assemblies. Faultfinder FF101C. The Producer.

You can see the FF101C at Booth 205 in the Southwest Printed Circuits and Microelectronics Exposition, in Dallas. And you can learn more about the FF303, the new test system for larger digital boards.

If you can't make the show, write for descriptive literature and data on all of the Faultfinder test systems.

**FF FAULTFINDERS Inc.**  
15 AVIS DRIVE, LATHAM, NY 12110 (518) 783-7786

## Consumers foreclose on EFT

Bankers, Government regulators, and equipment makers have all relearned a fundamental lesson in the drive toward electronic funds-transfer (EFT) systems. If the consumer is not willing to go along, the trip is off. That the consumer has been reluctant seems to be true, at least for the blue-sky vision of a national network of terminals linked to banks that would whisk money into and out of accounts electronically rather than by the cumbersome method of writing individual checks.

It turns out that those pursuing that vision did not anticipate the consumer reactions, which have ranged from indifferent to hostile. Some of the reactions are, no doubt, based on scanty information or misinformation, but the upshot is that bank customers simply do not want to surrender so much of the control over their funds. What is more, they do not like the idea of yet another group of computers taking over another aspect of their personal lives.

What consumers do like are systems that give them easier access to their money, such as cash-dispensing machines, or faster banking service, such as inquiry terminals. As long as they do not cost anything or do not impair traditional check-writing with its built-in float, new services are fine.

Apparently, consumer attitudes have not been shaped merely by reluctance to use terminals and computers, but by the impact a total EFT system would have on their ability to juggle their own finances. In addition, some 20% of the U. S. population, primarily the poor, does not use banks at all, and an EFT system is not likely to attract this segment. If anything, more automation is likely to

increase this group's reluctance to have any dealings with banks.

One basic problem is that the banks and the large equipment manufacturers have not done a very good job of informing the public about EFT, probably because they were too busy working on the benefits to themselves and forgot the users. If the backlash is surprising—and some bankers who are deep into EFT have expressed surprise—it shouldn't have been.

The National Commission on Electronic Fund Transfers got a late start in formulating a national policy. When it gets to deliver its final report in October, it is likely the banking community will have cooled considerably about going much further in trying new systems. The simple economic fact is that a widespread EFT network requires a huge volume of transactions. If the public is not ready to participate, those volumes won't be there.

EFT is not the first big dream to receive a rude awakening—remember the cable-television “wired nation” concept?—and will not be the last. What is important is that the consumer (or for that matter the end-user of any product) is the final judge of what will fly. When, in their zeal to start a bandwagon rolling, companies neglect this fact, there's usually disappointment.

In a sense the EFT commission's work is already done. By forcing all the participants to focus on what EFT is and how it works, everyone came down to earth. Since it got under way, the commission has conducted its business briskly and has been open to the public as well as the press. It's a pity there was a delay in organizing it.

# One source of ROMs overshadows all others

If you want 8K and 16K ROMs from the most skilled volume producer in the world, there's just one place to go.

Electronic Arrays pioneered the technology of MOS ROMs seven years ago. Introduced the world's first big 16K ROM over three years ago. Has now delivered 22 billion bits of ROM with over 1800 different mask programs to more than 400 customers worldwide. And every month we deliver another billion bits or more — in 18 different models including the popular 8316E ROM and the 2708 EPROM.

At other semiconductor companies, ROMs are only one of dozens of diverse products competing for attention. At EA, ROMs are the very heart of our business. So your order for ROMs receives the highest priority. You can expect very rapid delivery. And very low prices — because we've learned to fine-tune our production process to a peak of efficiency.

Price and delivery are excellent for another reason too. We make everything from the mask to the final package in house. There are no subcontractors to boost the cost or delay delivery.

So next time you need ROMs come to ROM COUNTRY: Electronic Arrays, 550 East Middlefield Road, Mountain View, Calif. 94043. Phone us on our toll-free WATS line (800) 227-9962 or our regular line (415) 964-4321.

In Europe you can reach us at Aalsmeer, The Netherlands 02977-23722. In the Far East, at Tokyo (03) 591-5241.

## ROM COUNTRY

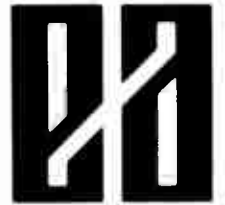

**electronic  
arrays, inc.**

Circle 13 on reader service card





DIP ISOLATORS  
**DIP ISOLATORS**  
**DIP ISOLATORS**

*OPTRON's complete line of optically coupled plastic DIP isolators offers immediate availability of standard devices for almost every application ... plus competitive pricing, high reliability and excellent customer service.*

*Check these features and choose the device best suited for your application.*



**GENERAL PURPOSE**

A full selection of DIP isolators with transistor and darlington outputs to match all popular industry standards. Current transfer ratios range from 2.0% to 500%.



**HIGH VOLTAGE**

For applications requiring an interface with high voltage circuits, select the OPI 6000 DIP isolator with a 300 volt output transistor.



**AC OPERATION**

The OPI 2500 DIP isolator features two input LED's operating in inverse parallel and is ideal for applications where the LED is driven from an AC line.



**CUSTOM SELECTION**

If your application demands "something a little different," OPTRON specializes in DIP isolators to meet special customer requirements.

*For reliability data and technical specifications on OPTRON's complete line of plastic DIP isolators, contact your nearest OPTRON sales representative or the factory direct.*



**OPTRON, INC.**

1201 Tappan Circle  
 Carrollton, Texas 75006, USA  
 TWX-910-860-5958  
 214/242-6571

## People

Making it big in the U.S.  
 is goal of Philips' de Lange

Marketing might is a major concern for the deputy director for technology of Philips Gloeilampenfabrieken's Industrial and Scientific Equipment division, Herman de Lange. He intends to help strengthen the Dutch electronics firm's position in test and measuring instruments in the world market and in the U.S. Partly for this reason, Philips recently decided to upgrade the division's test and measuring department to full "product group" status.

"The new group gives T&M operations a lot more profile and a higher degree of independence in planning investments and technical development," says the 46-year-old de Lange. A graduate of the Technical University at Delft, the Netherlands, and fluent in eight languages, de Lange points to automatic test equipment and, particularly, to test systems for microprocessors as two product areas that interest him and his company.

As for the U.S. market, he has no big changes to discuss yet. The move last month from Woodbury, N.Y., by Philips Test and Measurement Instruments Inc. to Mahwah, N.J., where the firm's X-ray and other equipment activities are housed, was made to enable sales support activities to expand, he says. Assembly operations in the U.S. are being considered for "within the next couple of years."

And Philips, which has become the No. 3 instrument maker behind Hewlett-Packard Co. and Tektronix Inc. since it entered the field in 1968, has no plans now for acquisitions in the U.S. But "this does not rule out the possibility of an expansion at some future time," he says from his Eindhoven headquarters.

How does the veteran executive of 20 years at Philips see the American market? "It makes no sense to enter that market with products that are not state-of-the-art according to U.S. criteria." The Dutch company introduced oscilloscopes into the U.S. in 1973 and counters at last

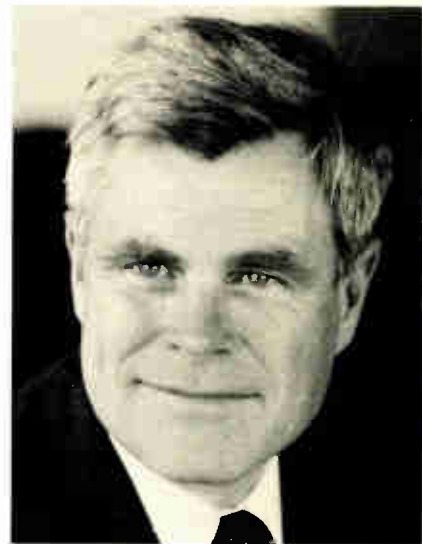

**Expander.** Herman de Lange will push general-purpose, TV test equipment in U.S.

year's Wescon show that are "up to American standards," according to de Lange, and go beyond in terms of reliability and ease of operation for the user. "Our plans call for expanding U.S. sales with high-quality general-purpose instruments and also with professional TV test equipment," he says.

Prime's Cashen keeps alert  
 on technology advances

Applying new technology is an old way of operating for Prime Computer Inc.—witness its volume shipments beginning next quarter of minicomputers with high-density boards using 16,384-bit random-access memories. And Joseph F. Cashen, new vice president for engineering at the Framingham, Mass., firm, is out to keep the company alert to the latest developments in hardware technology.

For the future, the 42-year-old Cashen, in the computer business most of his career, is keeping close tabs on the development of bubble and charge-coupled-device memories. "We've seen vendors putting more emphasis on bubble and CCD memories in the past six months," he observes, adding that there seem to be accelerating CCD efforts at companies like Fairchild Camera and

# Tired of selecting 741's and 747's to get premium performance?

## Specify our OP-02, OP-04, OP-14!

If your design requires premium 741 performance that right now can be met only by a costly and time consuming "selection game," the PMI OP-02 is for you.

A high performance general purpose Op Amp that really fills the gap between standard 741's and precision 725's, the OP-02 fits **all** 741 sockets. It's even better than the PMI SSS741! Input offset voltages are guaranteed better than the 725, but the speed of the 741 is retained. MIL STD 883 processing is available — level B right from stock.

Prices run higher than standard 741's, of course, but well below standard 725's. For a little bit extra you get **guaranteed** better performance across the board, low noise, low drift, low  $TCV_{OS}$ , low  $TCl_{OS}$ , and insensitivity to output load conditions. Check the specs.

Three steps to end your selection worries:

1. Get a complete OP-02 data sheet to compare to your selected 741 and 725 requirements.
2. Call your PMI distributor for a few OP-02's to convince yourself that PMI's specs are for real.
3. Specify the OP-02 as the **preferred** source. (You can still use the selected stuff as the second source.)

	Input Offset Voltage mV MAX		Input Offset Current nA MAX		Input Bias Current nA MAX	
	MIL	Comm.	MIL	Comm.	MIL	Comm.
<b>Industry Standard 741</b>	6.0	7.5	500	300	1500	800
PMI SSS741	3.0	7.5	10	50	100	200
PMI OP-02	1.0	3.0	5	10	50	100
<b>Industry Standard 725</b>	1.5	3.5	40	50	200	250
PMI SSS725	0.18	1.6	4	25	120	180

### DUALS also available!

Standard	Superior Second Source	Premium Performance
747	SSS747	OP-04
1458/ 1558	SSS1458/ 1558	OP-14



Precision Monolithics Incorporated  
c/o BOURNS AG  
Baarerstrasse 8  
6301 Zug, Schweiz



Circle 189 on reader service card

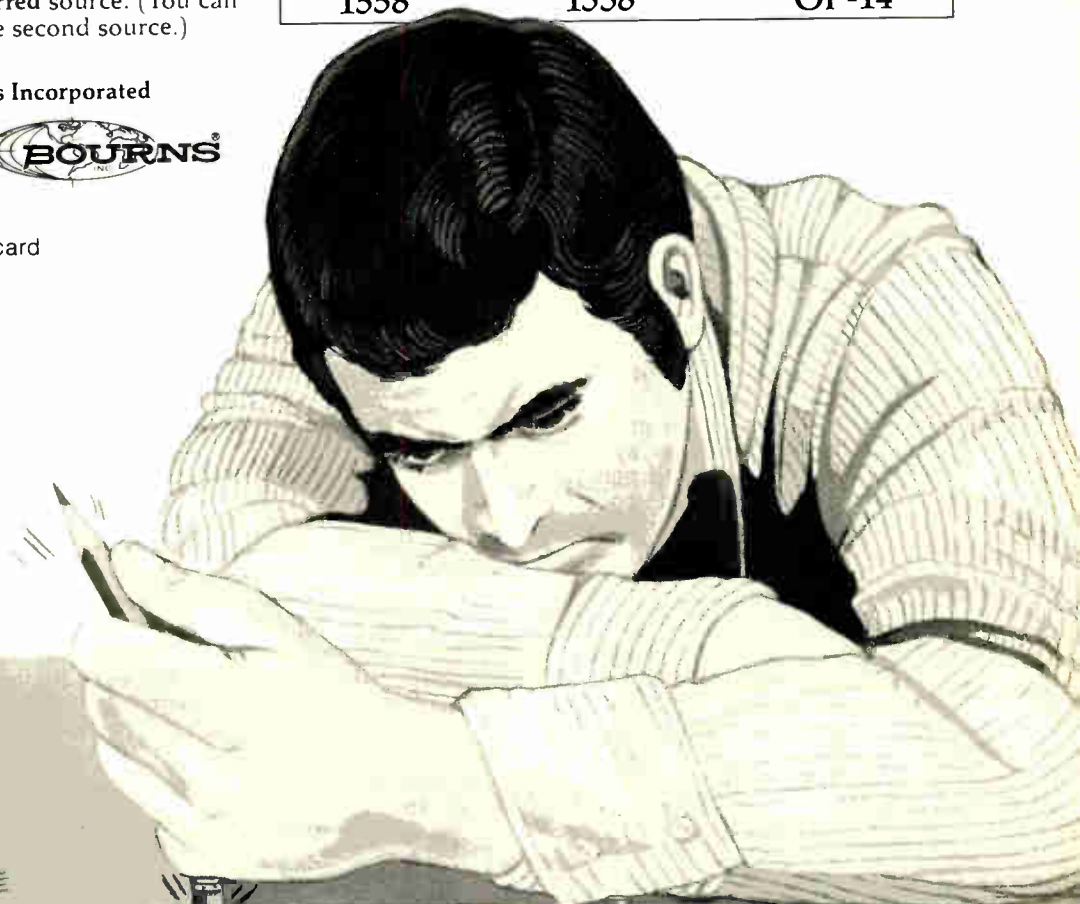

## THE NEW DIT-MCO SERIES 8210 AUTOMATIC WIRE CIRCUIT ANALYSIS SYSTEMS



### A CHOICE... FLEXIBLE, EXPANDABLE, POWERFUL SOFTWARE/HARDWARE TEST SYSTEM PACKAGES

#### Obsolete is Obsolete...

The DIT-MCO Series 8210, comprised of systems 8211, 8212, and 8213, offers the most complete package of automatic wire circuit test capabilities available to serve your present and continuing test needs. In fact, Series 8210 obsoletes the word obsolete. You can select the system to fit your current test requirements with certain knowledge that as your needs expand your DIT-MCO system can be upgraded to deliver!

#### Powerful Software/Hardware...

Series 8210 are real-time disc operating systems with disc file maintenance in the system.

Series 8210 systems are driven by fully interactive computer systems yet require no specialized operator training. A unique and comprehensive group of programs for testing, maintenance, and diagnostics are standard. Software is the evolutionary culmination of over five years experience and proven field use.

#### Eeny, Meeny, Miney...

You get a choice...to fit your budget. To fit your test needs. You get versatility, flexibility, the ability to expand and adapt.

And remember, when you choose DIT-MCO you have chosen Number One.

#### Too New to be Copied...

So new you won't find anything like it available anywhere else.

System 8210 incorporates all the "state of the art" advancements with some new wrinkles only DIT-MCO could provide.

So if you are going to look around for a comparison you will just have to compare the systems within the 8210 Series. None of the others come close.

#### Hand in Hand...

When you select DIT-MCO equipment you have bought not only the hardware and software you also get the Company...our over 25 years leadership in the field, our just reputation for treating every customer, big or small, with the same respect and dedicated service. With DIT-MCO you get it all!

#### Call or Write for Full Information...

A DIT-MCO representative can show you how Series 8210 or any of our complete line of interconnect test systems can accommodate your test requirements. Call or write us for full information.

#### DIT-MCO — The Difference in Testing...

**DIT-MCO  
INTERNATIONAL**

5612 Brighton Terrace  
Kansas City, Missouri 64130  
Telephone (816) 444-9700  
Telex Number 42-6149



**European Technical  
Representative**  
Radix House  
Central Trading Estate  
Staines Middlesex, TW18-4-XA  
England  
Telephone (0784) 51444  
Telex Number 935023

## People

Instrument Corp., RCA Corp., Rockwell International Corp., and Texas Instruments Inc.

"Things are really happening now" in CCDs, he notes. "We're not regarding them as competitive with MOS RAMs in price and performance yet, but they are beginning to push on the mass-memory technology," where Cashen expects them to be applied initially.

**Growth boom.** Things are really happening at Prime, too, as the company expands beyond its traditional computational time-sharing market into interactive data-base management systems. Prime doubled its 1975 sales of \$11.3 million to \$22.7 million last year as its larger computers, such as the Prime 400, began penetrating the business data-processing field. More than 70 of these systems, with prices averaging \$125,000, have been shipped, and the company has just introduced the Prime 500-based Transact with a \$500,000-and-up price tag. The new system also can be used for stand-alone data base management and direct communication with large mainframes.

The boom came after the company, founded in January 1972, had marginal growth in 1974. Projections are for another whopping sales increase this year—to \$56 million—which both satisfies and concerns the 42-year-old Cashen, who has been with Prime from the start and, most recently, was director of engineering.

He is concerned about keeping the engineering department responsive during such explosive growth. "We plan to at least double the head count in engineering this year," he says, "but, if we make our decisions the same way we did last year, we couldn't stand the length of the pipe."

**Faster decisions.** He means that many decisions would take too long if top management alone could make them. To prevent that, Cashen is adding more management levels where decisions can be made "without building in a lot of red tape. We've always been able to deliver products quickly, and we want to keep it that way."



# Choosing Systems or Components: Know your weapons.

Developed by Zilog. Manufactured by Zilog. Supported by Zilog. Here are the most powerful weapons on the microcomputer battlefield. Together or separately they herald victory over sluggish speeds and villainish inefficiencies.

## Manufactured by Zilog.

Whether you need one or a million and one, Zilog's new facility can deliver. All of our production equipment is state-of-the-art (4" wafers)—the most modern microcomputer manufacturing in the world. You order. We'll deliver, plastic or ceramic. Your choice!



## Masterminded by the Z80-CPU.

A single chip, N-channel processor arms you with a super-set of 158 instructions that include all 78 of the 8080A's and the 8085 instructions with total software compatibility. The new instructions include 1, 4, 8 and 16-bit operations, such as, memory-to-memory or memory-to-I/O block transfers and searches, 16-bit arithmetic, 9 types of rotates and shifts, bit manipulation and a legion of addressing modes. And that means less programming time, and less end user costs. With these features, the Z80-CPU generally requires approximately 50% less memory space for program storage yet provides up to 500% more throughput than the 8080A or the 8085. Powerful ammunition at a surprisingly low cost (less than \$10 each in large quantities) and ready for immediate shipment.



## Deploy the Z80 peripheral devices:

**Z80-PIO**—Parallel I/O Interface Controller. Two (2) ports for fast I/O transfer under full interrupt control.

**Z80-SIO**—Serial I/O Interface Controller. Two (2) fully independent full duplex channels that can be programmed to operate in any asynchronous or synchronous modes including Bi-Sync and HDLC/SDLC.

**Z80-CTC**—Counter Timer Circuit. Four (4) independent channels that can be used to count external events or to generate interrupts at programmable intervals.

**Z80-DMA**—Direct Memory Access. Programmable circuit that transfers data between memory and peripheral devices at up to 1.2 megabytes per second. The DMA can operate in a transparent mode without slowing the CPU.

## Deploy the Z80 software:

**Resident Macro Assemblers.** With cross-reference and conditional assembly, also relocatable assembler with linking loader.

**PLZ Resident Compiler.** Most powerful microcomputer compiler available today.

**Text Editor and File Maintenance.**

**Basic Interpreter.** For writing programs in Basic.

**Cross Software.** Available from NCSS.



## Made for the Military.

You can get Zilog components to meet MIL Spec 883B with extended temperature range of  $-55^{\circ}\text{C}$  to  $+125^{\circ}\text{C}$ . The Z80 component family operates with less power in MIL Temp environments.

## For victory over obsolescence:

Deploy these strong components from the leader in microprocessors. We are bound by our pledge to stay a generation ahead and determined to make your components and systems the most powerful in the field. We're ready to dispatch help immediately.



## Zilog

10460 Bubb Road, Cupertino, California 95014  
(408) 446-4666/TWX 910-338-7621

Boston (617) 890-0640

Chicago (312) 885-8080

Los Angeles (213) 540-7749

In Europe: Zilog, Inc., Nicholson House,  
High Street, Maidenhead, Berkshire, U.K.  
TEL 0628 36131/2/3/TLX 848-609

AN AFFILIATE OF EXXON ENTERPRISES INC

Circle 17 on reader service card

YOUR  
PRODUCT



# If your products produce raw data but your customers want results, here's a ready-made answer:

## HP computing controllers.

HP computing controllers can make your instruments "smart," fast. Economically. And without hassle.

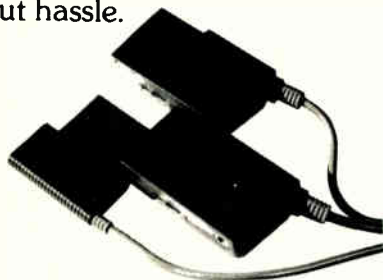

First, they're easy to interface. You simply connect your product to the appropriate HP interface card and plug into the computing controller. We know of users who have been up and running in less than a week. And you can choose from four commonly used interfaces—BCD, bit-parallel, RS-232C or HP-IB (HP's implementation of IEEE Standard 488-1975).

**You can reduce development costs.** Easy programming and easy interfacing save many costly hours in developing a ready-to-market product. And the costs are all up-front with HP computing controllers—visible before you make a commitment.



**You can extend product life cycles.** A mature product can receive a shot-in-the-arm when enhanced with automatic data acquisition and analysis capability. The cost could well be less than \$4000, depending on the specific computing and control requirement.

Ease of interfacing lets you consider retrofitting at custom-

er locations, if you desire. And worldwide HP service stands ready to back you up if needed.



**You can increase customer satisfaction.** The addition of data acquisition and analysis, inexpensively through HP computing controllers, adds visible value to your product—at a competitive price. Value, plus your customers' demonstrated respect for HP products, adds up to customer satisfaction.

We think these are powerful reasons why you should write for our brochure without delay.

*From computers-on-a-board to general-purpose systems, HP can meet your interfacing needs.*

HEWLETT  PACKARD

P.O. Box 301, Loveland, Colorado 80537

For assistance call: Washington (301) 948-6370, Chicago (312) 255-9800, Atlanta (404) 955-1500, Los Angeles (213) 877-1282

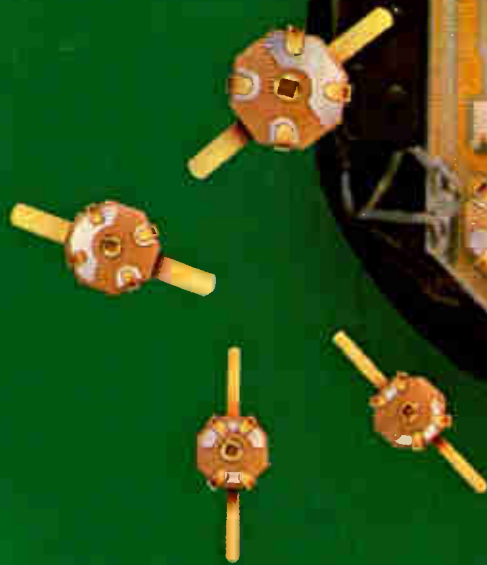

# Thin-Trim. capacitors

Tucked in the corner of this Pulsar Watch is a miniature capacitor which is used to trim the crystal. This Thin-Trim capacitor is one of our 9410 series, has an adjustable range of 7 to 45 pf, and is .200" x .200" x .050" thick.

The Thin-Trim concept provides a variable device to replace fixed tuning techniques and cut-and-try methods of adjustment. Thin-Trim capacitors are available in a variety of lead configurations making them easy to mount.

A smaller version of the 9410 is the 9402 series with a maximum capacitance value of 25 pf. These are perfect for applications in sub-miniature circuits such as ladies' electronic wrist watches and phased array MIC's.

*Johanson*

Johanson Manufacturing Corporation  
Rockaway Valley Road  
Boonton, New Jersey 07005  
(201) 334-2678 TWX 710-987-8367

## Meetings

**IECI '77: Industrial Applications of Microprocessors**, IEEE, Sheraton Hotel, Philadelphia, March 21 - 23.

**National Association of Broadcasters Annual Convention**, NAB (Washington, D.C.), Shoreham Americana and Washington Hilton Hotels, Washington, D.C., March 27 - 30.

**1977 International Semiconductor Power Converter Conference**, IEEE, Walt Disney Contemporary Hotel, Orlando, Fla., March 28 - 31.

**Salon International des Composants Electroniques**, Porte de Versailles, Paris, France, March 31 - April 6.

**Microcomputer '77 Conference and Exposition**, IEEE, Lincoln Plaza Forum, Oklahoma City, Okla., April 6 - 8.

**Fifteenth Annual International Reliability Physics Symposium**, IEEE, Caesars Palace, Las Vegas, April 12 - 14.

**Fifth Annual New England Bioengineering Conference**, University of New Hampshire, New England Center, Durham, N.H., April 14 - 15.

**National Information Conference and Exposition**, Information Industry Association (Bethesda, Md.), Shoreham Americana Hotel, Washington, D.C. April 18 - 21.

**Electro '77**, IEEE, New York Coliseum and Americana Hotel, New York, April 19 - 21.

**Society for Information Display International Symposium**, SID (Los Angeles), Sheraton Boston Hotel, Boston, April 19 - 21.

**Eighth Annual Pittsburgh Conference on Modeling and Simulation**, IEEE, University of Pittsburgh, *et al.*, Pittsburgh, Pa., April 21 - 22.

**Annual Meeting and Exposition of the Electronics Division of American Ceramic Society**, (Columbus, Ohio), Conrad Hilton Hotel, Chicago, April 23 - 28.

# AMP component sockets are sealed with silicone rubber. And can be inserted at up to 7,000 an hour. You can't beat that.

AMP component sockets. They're the ones that come in strip form. You can insert them at high speed and cut your costs. Use a bench press or, for really fast loading, a N/C machine. AMP can furnish the applicator and interface module for compatibility with most N/C machines.

And AMP keeps your product out of trouble by sealing its component sockets with silicone rubber. Which ends solder flux contamination and solder flooding.

Of course, they provide easy pluggability with either rectangular integrated circuit leads or .016 inch-.019 inch diameter leads. Their small head diameters permit .100 inch center-to-center mounting. Our sockets help you save on board costs too, as they seat securely in wide tolerance holes.

For more data on AMP component sockets, ask your AMP Sales Engineer. He's ready to help you in any way possible. Or write or call AMP Incorporated, Harrisburg, PA 17105. (717) 564-0100.

**AMP**  
INCORPORATED

Circle 21 on reader service card

World Radio History

AMP is a trademark of AMP Incorporated.

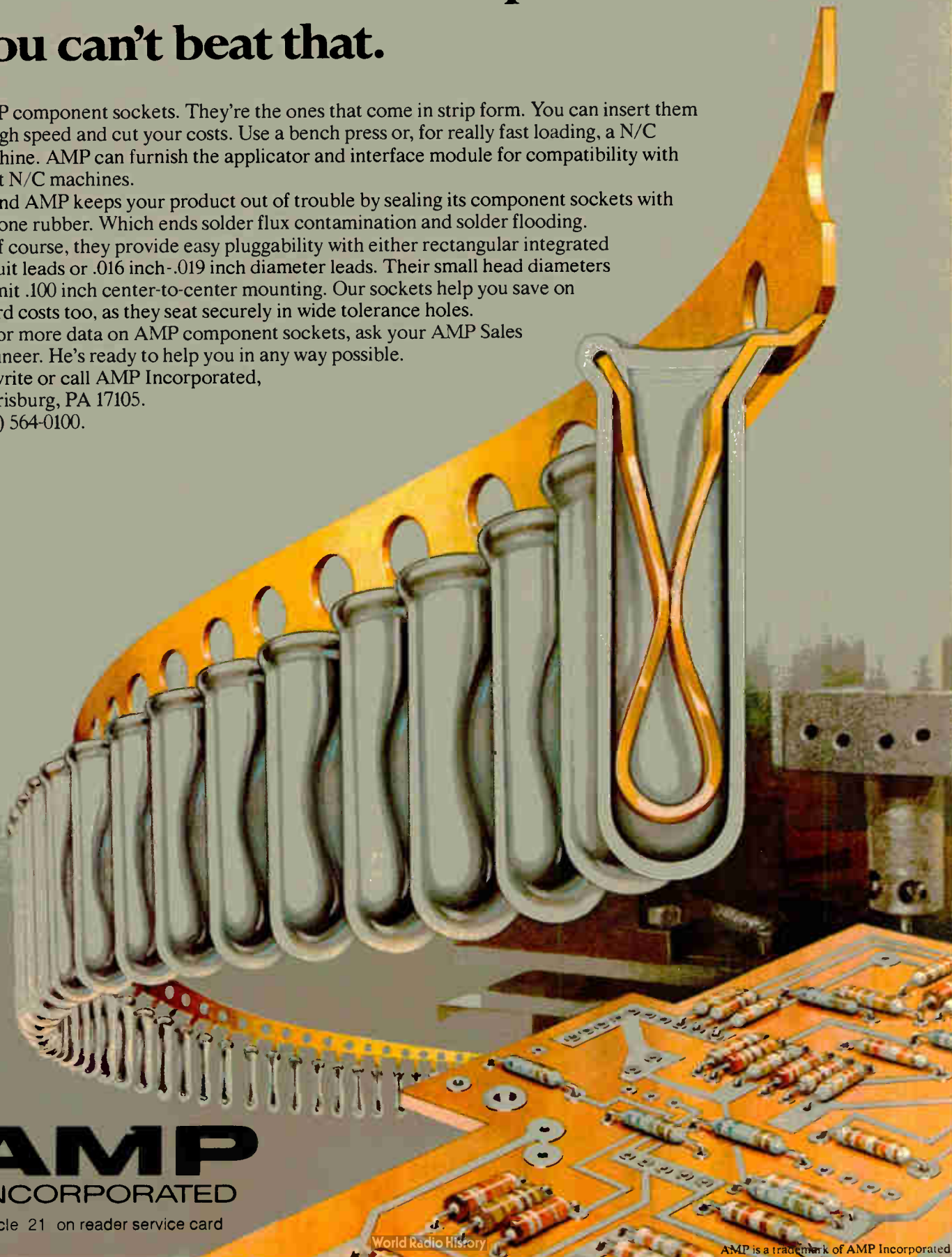

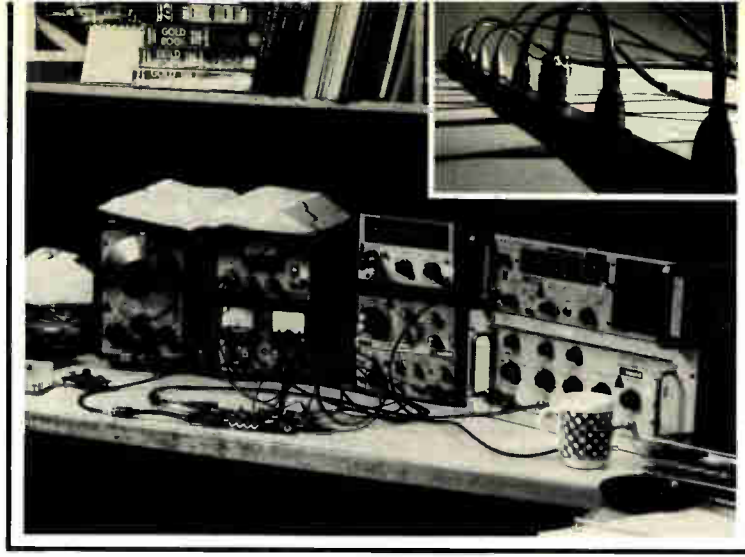

# Here's an idea that could change your thinking about test equipment.

A complete test station doesn't have to be an assortment of special-function instruments. A working workbench doesn't have to be crowded and unhandy. And a truly portable test lab doesn't have to be out of reach.

**TM 500 offers you an alternative:** a modular line of compact, interchangeable plug-ins and mainframes. Multiconfigurable both in packaging and in performance, TEKTRONIX TM 500 is designed around the idea that test equip-

ment which is compatible in every respect can, in fact, cover a broader range of functions and meet a wider variety of measurement situations. To say nothing of its ability to adapt more readily to new challenges.



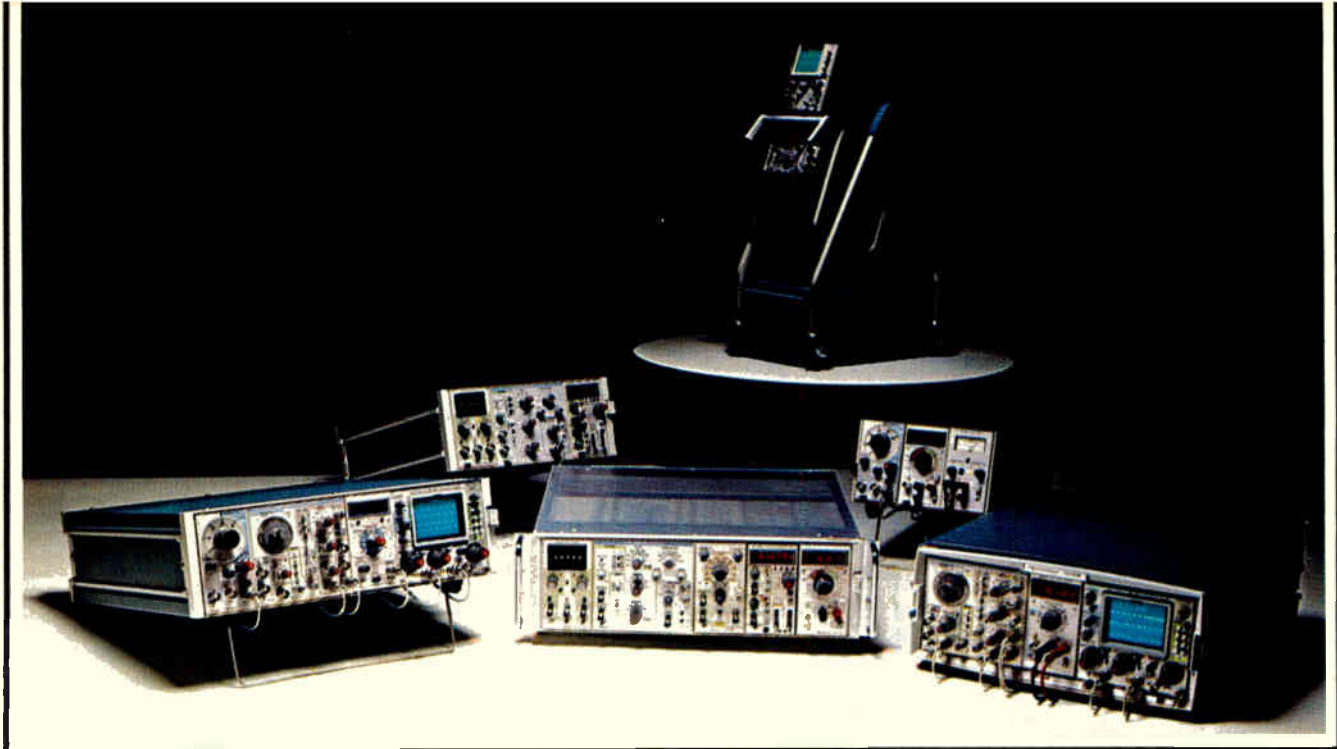

**Modular** DMMs, counters, generators, amplifiers, power supplies, oscilloscopes, logic analyzers, and word recognizers can be interfaced electrically. Signals



can be routed from one plug-in board to another via the mainframe mother board, thus enabling you to build a test instrument that's more powerful than the sum of its parts.

**The plug-ins can be configured** together in six widths of mainframe and four types of packages, depending on where and how you'll use them. Select the plug-in modules you need just as you would monolithic instruments, and then combine them in the appropriate mainframe for a

convenient, uncluttered bench setup; mount up to 6 functions



side-by-side in a 5¼-inch rack; build a rollabout station that "follows" you around the lab. Or



pack a portable test station in the small-as-a-suitcase TM 515 Traveler Mainframe, which carries up to 5 modules and typically weighs less than 35 pounds, including the modules.

**The result** is a total test system that looks like a unit . . . works as a unit . . . yet is still configurable to new or changing measurement requirements. So the next time you're looking into test instrumentation, specify the one product line that's designed for configurability.

For further information or a demonstration of TM 500 Instrumentation, write or phone: Tektronix, Inc., P.O. Box 500, Beaverton, Oregon 97077, (503) 644-0161 ext. 5283. In Europe: Tektronix Limited, P.O. Box 36, St. Peter Port, Guernsey, Channel Islands.

**Tektronix**  
COMMITTED TO EXCELLENCE

**TM 500...designed for configurability.**

For Technical Data circle 23 on Reader Service Card  
For Demonstration circle 22 on Reader Service Card.

# Hot-molded resistors provide low temperature coefficient and unmatched reliability.

The Resistance Temperature Coefficient of Allen-Bradley hot-molded fixed resistors is typically less than 200 PPM over the entire resistor range shown in the normal equipment operating temperature of +15°C to +75°C. Excellent RTC ratings have always been an Allen-Bradley benefit. And consistency of Allen-Bradley resistors means repeatable results and tight performance patterns. Allen-Bradley resistors offer the **lowest cost—on the board—**where it counts!

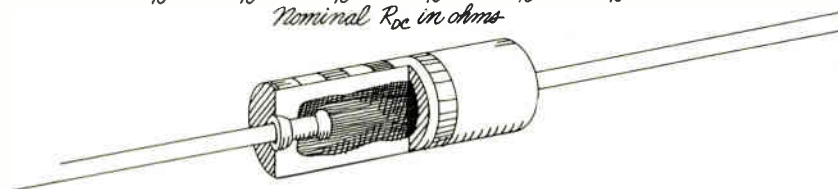
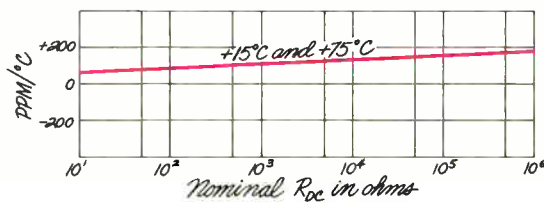

## Reliability

is unsurpassed. Over 700 million unit test hours without a single failure.

## No coatings

Insulation and resistance element integrally molded into one solid structure.

## Pulse handling

characteristics offer outstanding protection against surges and transients.

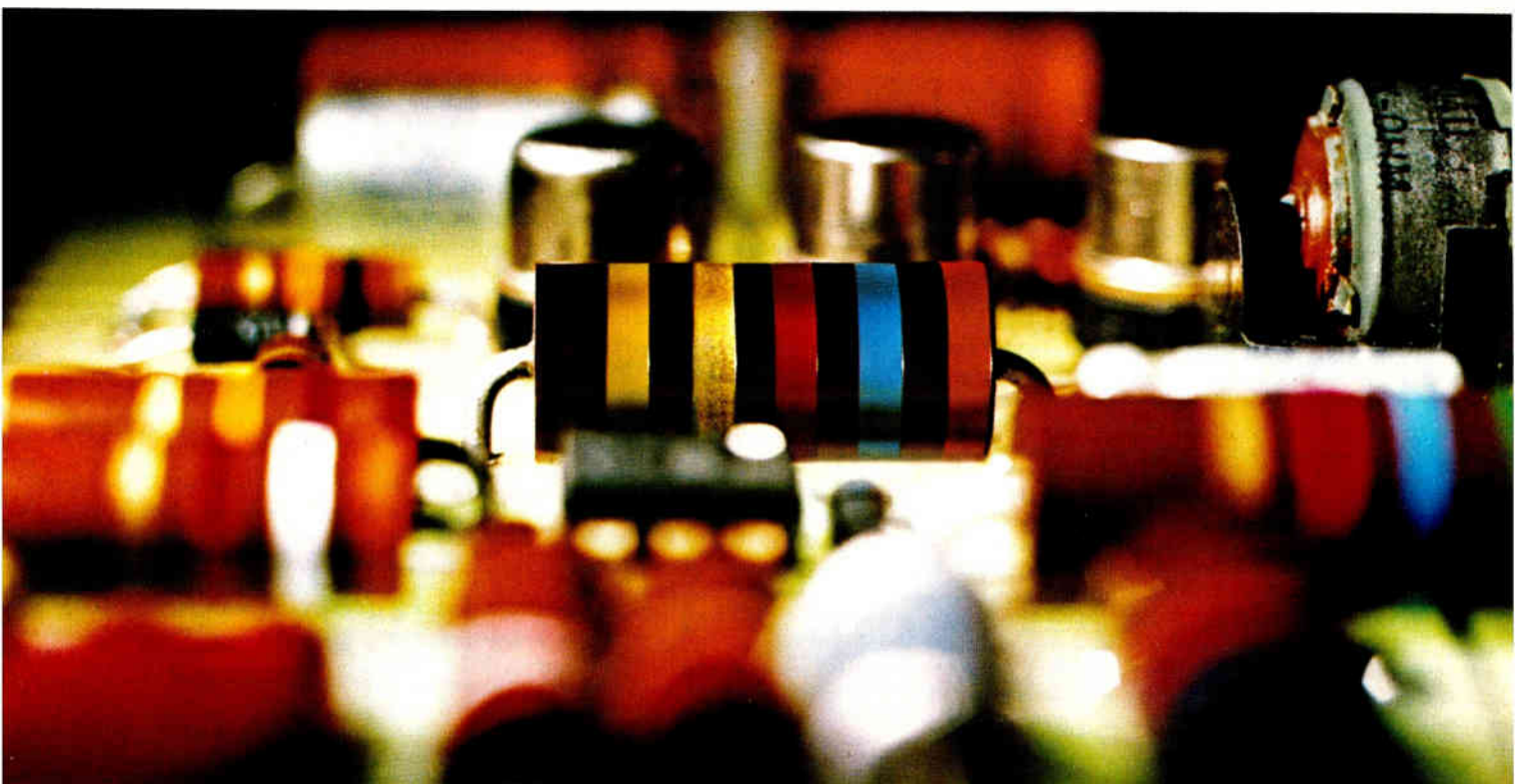

## Quality in the best tradition.



### ALLEN-BRADLEY

Electronics Division  
Milwaukee, Wisconsin 53204



## **Intel to double microcomputer chip program memory . . .**

Even as Intel Corp. begins shipping samples of its one-chip MCS-48 microcomputer [*Electronics*, Nov. 25, 1976, p. 99], it is planning more powerful versions. Coming in the third quarter is a 2,048-byte read-only-memory version of the 8048 chip that **not only contains twice the program memory, but also has beefed-up computational capability.** A ultraviolet-erasable 2-kilobyte chip using Intel's new EPROM 5-volt process is also in the wind, as is a cheaper, less powerful 8047 stand-alone one-chip device for very-low-end controller applications.

## **. . . and readies microprogrammable serial controller**

To work with high-performance multichip microprocessor designs such as the 8085, Intel will make available in the second quarter a microprogrammable controller chip, which Intel will program as either a floppy-disk or a synchronous data-link controller. **Most impressive is the chip's architecture: it is a dual processor.** The front-end bit processor handles high-speed (250-ns) data-bit operations, and a back-end byte processor has 46 instructions with minimum execution time of 1.25 microseconds. Easily the most impressive of the big controller chips coming on the market, the 5-volt device is built with the company's high-performance oxide-isolated n-channel MOS process, which borrows depletion-loading and substrate-biasing from its high-speed random-access-memory designs.

## **Will Heath market a hobby computer kit?**

Neither company will confirm the strong rumors along the hobby-computer grapevine that Heath Co. is readying a personal-computer kit based on Digital Equipment Corp.'s LSI-11 microcomputer technology. DEC won't comment on the rumors, **but it's known that a Heath delegation recently visited the Digital Components group** in Marlboro, Mass. Of that visit, a Heath official says only that "we will have been a lot of places by the end of the year."

## **Liquid-crystal light modulator moves toward development**

Reflecting considerable industry interest, Hughes Aircraft officials are moving toward commercial development of its cadmium sulfide/liquid-crystal "light valve." Developed at Hughes' Malibu research laboratories [*Electronics*, Dec. 11, 1975, p. 30], **the device allows real-time manipulation on an image, including brightening, enhancing, and projecting.** Along with transferring work from Malibu to the Industrial Products division, Carlsbad, Calif., for engineering development, a market study will be conducted on the best way to exploit the device. Alex Jacobson, who was instrumental in earlier valve work, will direct the effort as manager of liquid-crystal programs.

## **Distributed processing will 'fly' at RCA**

Distributed processing systems in space are no more than one or two years away, says Charles Staloff, manager of command and data handling at RCA Astro Electronics in Princeton, N.J. **Replacing brute-force logic and a central computer, a distributed-processing architecture with microprocessors allotted for distinct functions will appear in the next generation of spacecraft,** he says. The RCA Corp. division has already developed some microprocessor-based modules to handle such functions as telemetry, powering, attitude control, command decoding and processing, data busing, and some guidance calculations.

## **Congress urged by IEEE to halt wage busting**

The Institute of Electrical and Electronics Engineers is lobbying Congress hard to support legislation to halt "wage-busting" tactics by service contractors at Federal installations. Wage busting, according to IEEE, occurs when **engineers are threatened with layoffs unless they agree to accept salary cuts when a service contract must be renewed.** The outlook for the institute's efforts appear promising in view of the introduction of legislation cosponsored by Representatives Frank Thompson, Jr. (D-N.J.), chairman of the House Education and Labor subcommittee on labor-management relations, and James C. Corman (D.-Calif.).

## **TI halves 8-k EPROM prices . . .**

In a move that signals still further reductions, Texas Instruments is halving the prices of its family of erasable programmable read-only memories. In lots of 100, the company's 8,096-bit TMS2708 is now \$32.75, and the TMS27L08, the low-power version, is dropping to \$37.75. **What is more, the price of its new 16,384-bit TMS2716, samples of which were ready last month, will be \$54.75**—less than the published price for Intel Corp.'s 8-bit part. The TI 16-bit EPROM, which will go into volume production next month, plugs into 2708 sockets, and it has an access time of 450 nanoseconds. Typical power dissipation is 375 milliwatts; maximums are 700 mw at 0°C and 500 mw at 70°C. This month, the company also will start distributing samples of the industry's first full-temperature-range (-55 to +125°C) 8-k EPROMS.

## **. . . as National cuts op-amp price tags**

Citing improvements in manufacturability and yields, National Semiconductor Corp. is reducing prices on its bi-FET series of operational amplifiers by 25% to 70%. In addition, the Santa Clara, Calif., firm is introducing the LF351 op amp, **a possible precursor of a new series based on an improved, lower-cost process.** Priced at 48 cents in volume, the new part has performance specifications that are 30% to 60% better than the nearest comparable part, Texas Instruments' TL081, which costs 52 cents.

## **Semi readies 8-k static RAM**

While most of the industry still struggles with 4,096-bit MOS static RAM designs, Semi Inc., the Phoenix-based semiconductor division of Electronic Memories and Magnetics Corp., is looking ahead to the 8,192-bit level. According to John M. Hartman, product design manager, the firm will be offering a 1,024-by-8-bit device by the end of the year. **The 24-pin 8108, which will run from a single 5-volt supply and operate in the 300-nanosecond range,** will be pin-to-pin compatible with the popular 2708 ultraviolet-erasable PROMS. Also to be introduced is a 2-k static RAM that will be socket compatible with Fairchild's 3539, which Semi plans to supply in its own 300-ns version.

## **Univac computer to use bubbles**

Sperry Univac's R&D work in bubble memories may bear its first fruit before 1977 is out. The Sperry Rand Corp. division in Blue Bell, Pa., plans to use bubble memories in a computer system, and feasibility models will be out for field evaluations no later than early 1978, according to a spokesman in the division's Research and Advanced Technology department. **Whether the bubble memories initially will be used for a new computer or retrofitted into an existing system has not been decided yet.**



HEAD-UP DISPLAY SYSTEM



GROUND STATION DISPLAY SYSTEM

**DDC has done it again . . .** putting together a series of high reliability ultra low-glitch display DACs that out-perform any others.

These low-noise, high-quality thick-film D/A converters are all processed in accordance with the exacting requirements of MIL-STD-883 . . . and are actively at work in such demanding environments as

head-up display systems, ground station displays, video processing systems and others where ruggedness and reliability are the only things that really counts! All are proven performers.

If your requirements are for the best possible display DACs, let us send you full details on these perfect problem solvers.

- ADH-030 — high-speed 50MHz 12-bit thick-film hybrid in a 24-pin DDIP configuration. Features current output with a settling time of 50ns for full-scale changes and 20ns LSB. ECL logic for extremely low glitch.
- DDAC — Ultra-low glitch available as two DDIP packages, plus TO-3 case with 13-bit monotonic output, programmable  $\pm 2.5$ , 5 or 10V outputs with 500 mA coax drive capability. 25ns one LSB settling, internal or external reference with short circuit protected output.
- SDAC — Compact 13-bit, 24-pin DDIP with settling time of 500ns @ 2.5V, 1 $\mu$ sec. for .5V and 1.6  $\mu$ sec. for 10V, to .05.

# DDC sets the pace in display DACs...



**with the first hybrid, glitchless (<sup>500</sup>mV/ns), high performance converters.**  
(speeds up to 50MHz)

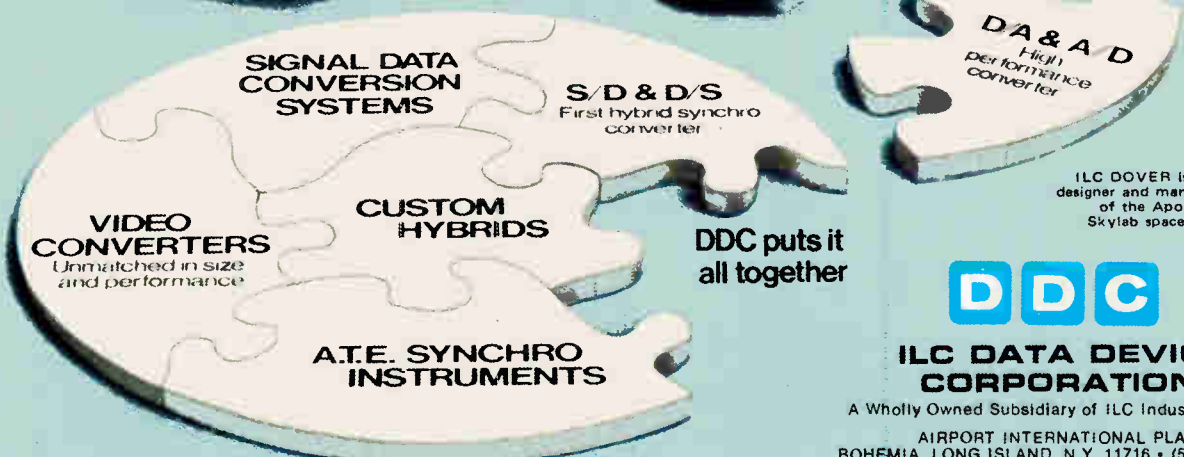
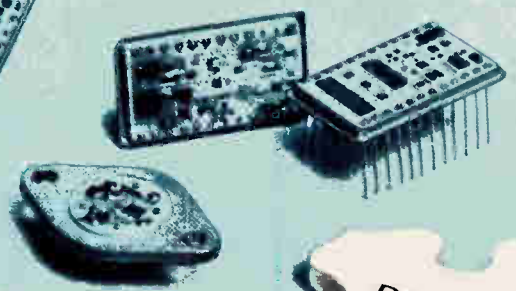

**DDC puts it all together**

ILC DOVER is the sole designer and manufacturer of the Apollo and Skylab space suits.



**ILC DATA DEVICE CORPORATION**

A Wholly Owned Subsidiary of ILC Industries, Inc.

AIRPORT INTERNATIONAL PLAZA  
BOHEMIA, LONG ISLAND, N.Y. 11716 • (516) 567-5600

West Coast: 7337 Greenbush Ave., N. Hollywood, CA 91605 • (213) 982-6454  
Interested engineers, write or call Harry Lewis or send for our 164-page product line catalog

**Rockwell  
one-chip computers  
give you the right fit  
at the right price.**

**Right now.**

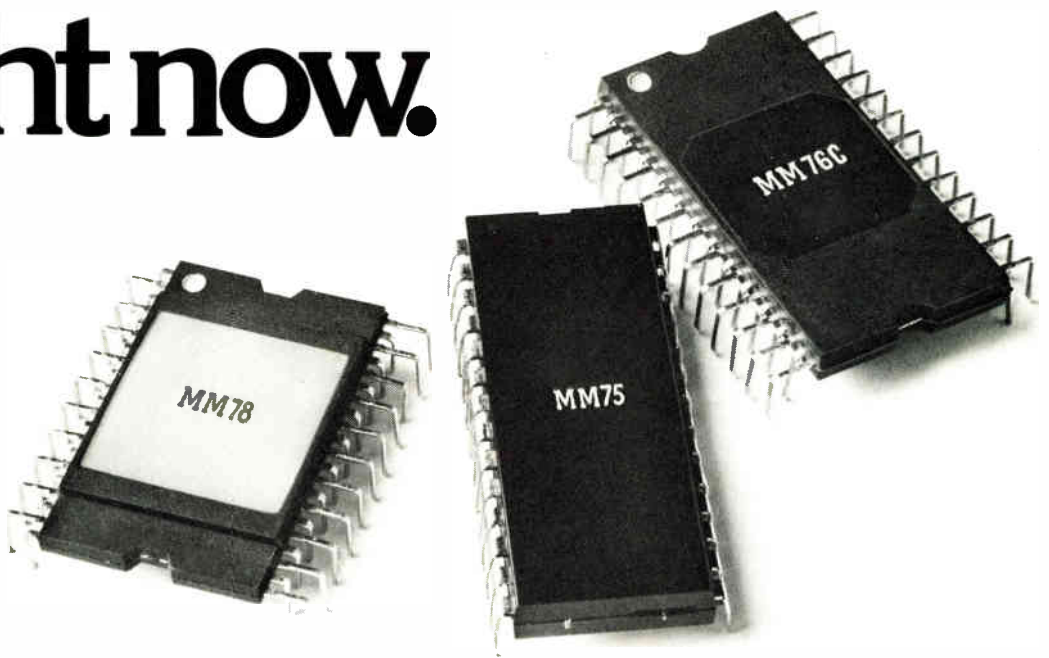

If you're designing a system or subsystem requiring as few as 10 TTL circuits, cost alone is reason enough to consider a Rockwell one-chip computer.

A wide choice of Rockwell one-chip computers is available right now. And the line-up of compatible one-chips is growing fast.

From Rockwell's PPS-4/1 family, you select the most cost-effective computer for your application.

### More on-chip I/O eliminates extra interface devices.

All of Rockwell's one-chip computers offer powerful, user-oriented I/O ports that eliminate costly interface circuitry in overall systems.

I/O features, including bidirectional ports, flexibly designed drivers and receivers, and serial input/output ports, provide you with powerful system options.

Many types of displays can be driven directly. Analog-digital conversion is easy. And serial I/O ports offer a new dimension of capability by giving you simple, "no-cost" interfacing for multi-computer systems.

### Rockwell flexibility assures cost-effective design.

Rockwell's one-chip computers give you design options you couldn't afford with other logic approaches.

During the design stage you can add or reduce functions, allocate I/O differently and make dozens of other changes by simple reprogramming or by moving to another software-compatible chip within the family.

### Powerful instruction sets increase efficiency.

Rockwell's instruction sets provide ROM efficiencies of typically 2 to 1 over other microcomputers. For example, some one-byte multi-function Rockwell instructions perform operations requiring five instructions in other systems.

More than 80% of Rockwell's instruction

types can be executed in one byte and in a single cycle. Special ROM instructions allow many subroutine calls to be handled in one byte. Table look-up instructions for MM77 and MM78 chips provide easy look up of stored data and easy keyboard decoding with minimal programming.

### The PPS 4/1 family of one-chip computers.

Model	MM76	MM77	MM78	MM75	MM76C	MM76D	MM76E
Description	Basic 76	Basic 77	Jumbo 77	Economy 76	High speed counter <sup>a</sup>	12-bit A/D converter	Expanded 76
ROM (x8)	640	1344	2048	640	640	640	1024
RAM (x4)	48	96	128	48	48	48	48
Total I/O lines	31	31	31	22	39	37	31
Cond. Interrupt	2	2	2	1	2	2	2
Parallel Input	8	8	8	4	8	8	8
Bidirectional Parallel	8	8	8	8	8	8	8
Discrete	10	10	10	9	10	10	10
Serial	3	3	3	—	3	3	3
In-line package	42 pin quad	42 pin quad	42 pin quad	28 pin dual	52 pin quad	52 pin quad	42 pin quad
Availability	Now	Now	Now	2Q 77	2Q/77	3Q 77	16 wk ARO

Power supply is 15v except low voltage version of Basic 76 available 3Q 77. Typical power dissipation is 70mw.

<sup>a</sup>Two 8-bit or one 16-bit presettable up/down counter with 8 control lines.

### Rockwell design aids also help lower your system cost.

To help control development costs, Rockwell makes available a universal Assembler that lets you assemble, edit, develop and debug programs, as well as load PROMs. Special development circuits enable prototyping.

Your Assembler can also handle incoming inspection and factory testing. And the same Assembler can be used to develop systems based on all Rockwell one-chip and multi-chip microprocessors.

For the full story on Rockwell one-chip computers, and how quickly they can be a part of your new product, write on your company letterhead to: Marketing Services, D/727-E, Microelectronic Device Division, Rockwell International, P.O. Box 3669, Anaheim, CA 92803, U.S.A. or phone (714) 632-3729.



**Rockwell International**

# First Fast FIFO

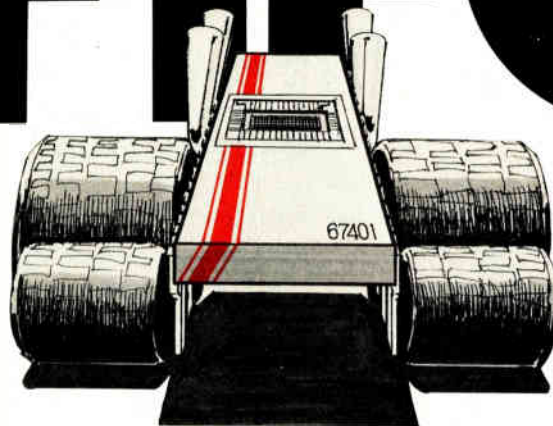

**At 15 MHz the 67401  
should come with  
mag wheels and  
a racing stripe.**

If you need to load and read out data at the same time, and at different speeds, and one of those speeds is pushing 15 MHz, then this new bipolar FIFO is your part.

And it's available NOW, in production quantities. Need some? Call, TWX, or write.

## Features

- 15 MHz typical speed
- 64 x 4 organization
- Expandable in width and length
- 16 pin package
- Pin compatible with Fairchild 3341 1 MHz MOS FIFO
- TTL compatible

## Applications

- Disc to system data transfer
- Buffer between head-per-track disc and memory
- Slow memory to high speed CPU data transfer
- Radar data acquisition

Device	Temperature	Pins	100 up Price
67401	Commercial	16	\$28.00
57401	Military	16	\$56.00

### United States

Monolithic Memories, Inc.  
1165 East Arques Avenue  
Sunnyvale, CA 94086  
Tel: (408) 739-3535  
TWX: 910-339-9229

### Europe

Monolithic Memories, GmbH  
8000 Munich 80  
Mauerkircherstr. 4  
West Germany  
Tel: (089) 982601, 02, 03, 04  
Telex: (841) 524385

### Far East

MMI Japan, K.K.  
2-2, Senadgaya 4-chome,  
Shibuya-ku,  
Tokyo 151, Japan  
Tel: (03) 403-9061  
Telex: J26364

# Monolithic Memories

## Three-pound printer duplicates a CRT screen in a second

Spinning at 1,800 rpm, unit prints 2,200 c/s on 4-inch-wide paper, costs as little as \$300

Using a radically new design, a company has put together a printer that operates at 2,200 characters per second, yet sells in quantity to original-equipment manufacturers for as little as \$300. Before next year, the company, which had never before built a printer, will be making a 4,000-c/s machine for only 30% more.

The innovator is SCI Systems Inc., a \$25-million-a-year designer and manufacturer of electronic systems and products for aerospace and industrial applications. The Huntsville, Ala., company has supplied its printer to Docutel Corp., which is ecstatic about its performance in a cathode-ray-tube administrative terminal being built for banks.

"It's unbelievable," declares Christopher H. Williams, a senior product manager at Docutel in Dallas. "Not everybody we show it to believes it, either. They think we have a trick up our sleeves when they see a whole [CRT] screen put on paper in a second."

Even though chain printers of the IBM 1403 type, as well as drum and laser printers, can print 2,200 characters per second and more, they sell for well above \$20,000.

The operating assembly of SCI's rotary printer, which writes by zapping current through electro-sensitive paper, resembles a squat electric motor and is about 4 inches in

diameter and 6 in. long. It writes across 4-in.-wide paper in the 132- or 136-column format of standard computer printouts. With its electronics and a paper feeder, the printer is about 9 in. long and weighs three pounds. It prints in a 5-by-7-dot matrix, but a 7-by-9-dot format will be available within four months, says president Olin B. King.

SCI's printer design is different because there is continuous motion of both the writing head and paper; once in motion, there is no stopping or starting of one or both as is usually the case, says King. In addition, the actual speed of the writing head is flexible; electronics synchronizes it to the speed of the paper at any instant. Writing is so fast, it is

feasible to make multiple copies by reprinting each message, he points out.

The print mechanism consists of three rows of styluses, each row parallel to the axis of the cylindrical printer and spaced 120° apart round its circumference. The paper is curved to match the cylinder, in an arc that subtends the same 120°.

For the 5-by-7-dot matrix, there are five weighted tungsten-alloy styluses in each row, connected to a central rotor by fiberglass leaf springs. A small dc motor turns the rotor with a nylon belt. As the styluses whirl around at 1,800 revolutions per minute, centrifugal force pushes them outward against the paper. An entire vertical column of

**Speeder.** With a 4-inch-wide roll of electro-sensitive paper and its electronics on a printed-circuit board, rotary printer from SCI Systems fits easily in one hand.

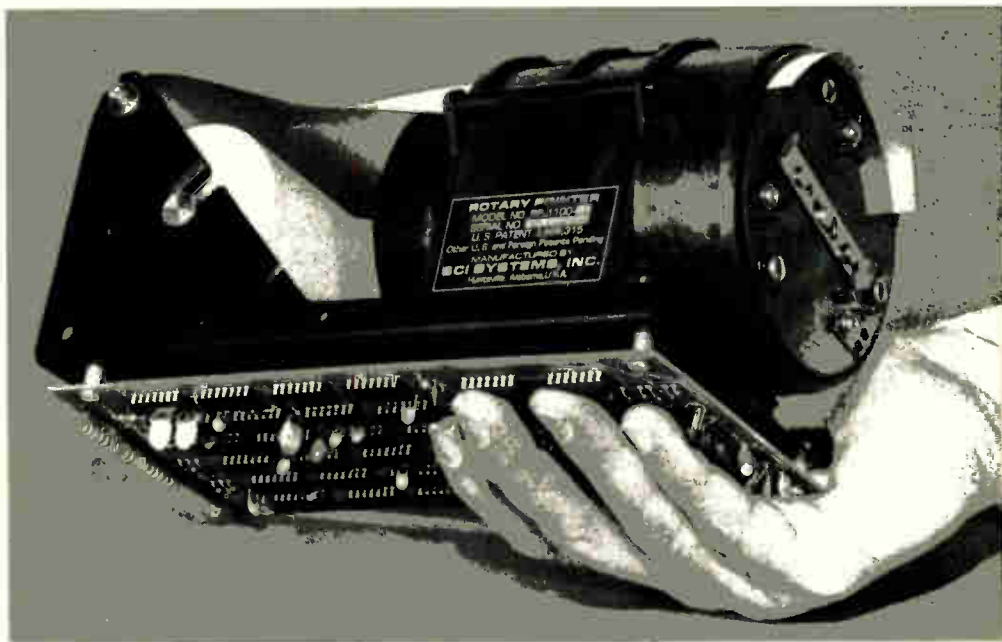

### \*\* A PRINTER TECHNOLOGY

DATA THROUGHPUT RATES  
ERN DATA PROCESSING E  
TABLISHES THE NEED FO  
COST DATA PRINTER. S  
SATISFIES THESE REQUIR  
"QUIKPRINT" INCORPORAT  
HEAD TO PRINT CHARACTE  
ELECTROSENSITIVE PAPER  
TABLISHED VENDORS STO  
STANDARD ITEM. INHER'  
TINUOUS AND SYNCHRON  
PRINT HEAD AND THE PA.  
NUMBER OF MOVING PARTS  
QUIET AND HIGHLY RELI  
PRINT QUALITY (CONTR  
IS MAINTAINED ESSENTI  
WIDE VARIATIONS IN OPT  
AUTOMATIC BLACKNESS C  
ELECTRONIC STORAGE OF

characters is printed as the print head turns through 120° across the 4-in. depth of the paper, and the paper then moves into position for the next vertical column.

**Perseverance.** King had the idea about two and a half years ago, but it took about \$1 million for his engineers to realize it. "At first they told me it couldn't be done, but I told them to keep at it," says King. "I had to maintain my self-respect," he adds with a chuckle. SCI has built the print head into a hockey-puck-like package that plugs easily into one end of the printer. At \$40, or \$25 with a trade-in, the head is "quasi-expendable," says King, who adds that it is good for 25 million characters before it must be replaced.

Most of the electronics for the printer fits on a single printed-circuit board mounted beneath the unit. It contains a standard RS-232-C serial or parallel interface to go "from the outside world to a full-page buffer memory," King says. However, he will supply any interface desired.

The buffer memory consists of 4,096-bit metal-oxide-semiconductor random-access devices. Eight of them buffer a page of up to 136 columns of data. Information is read out through an off-the-shelf character generator that drives the inputs to the stylus drives. The position of the styluses is indicated by slots near



**Here's the word.** Print head, which pops into printer's plastic housing, writes one complete column at a time as paper, shown in real size, moves from right to left.

the outer circumference of an optical code wheel, which are sensed by a photocell. The position of the code wheel determines the time writing current is applied to each stylus. The printer dissipates 5 watts standing by and 50 watts when it is printing.

**Larger printer.** By the end of the year, SCI will be producing a larger-diameter 6-pound unit that will write at 4,000 c/s, King claims. Its 7-by-9-dot matrix will write in several modes, including 50 lines and 80 columns, 50 lines and 132 or 136 columns and on 8½-by-11 or 8½-by-14-in. paper.

SCI's \$300 price applies to OEMs that order at least 1,000 printers per year. These are supplied with a simple interface and work off a power supply in the OEM's terminal. The price for a more complex unit with an RS-232-C interface, a power supply, and fully buffered for 136 columns can reach \$995. □

## Memories

### Intel, AMI promise 50-ns devices

Memory speeds below 50 nanoseconds are the promise of two metal-oxide-semiconductor technologies announced at the recent ISSCC. Such

speeds signal an invasion by static-MOS random-access memories of the territory pretty much owned by bipolar RAMs—high-performance cache and buffer memories. At stake is a \$50 million market expected to double by 1980.

Two Santa Clara, Calif., firms unveiled the new MOS techniques last month at the International Solid State Circuits Conference in Philadelphia. Intel Corp. presented an advanced oxide-isolated process, and American Microsystems Inc. reported on its V-groove process.

Unlike the mainframe memory market, which is dominated by 150-to-300 ns dynamic MOS RAMs, the cache and buffer systems presently are served almost exclusively by static RAMs built with bipolar technology. Fairchild Semiconductor, Mt. View, Calif., is the principal supplier of these RAMs with over thirty 256- and 1,024-bit transistor-transistor and emitter-coupled logic devices. The only MOS device that's presently available for these applications, Intel Corp.'s 70-ns 2115 and 2125, are acceptable for only the slowest systems.

**All stops out.** Intel Corp.'s memory design group, directed by Richard Pashley, has developed an advanced MOS technology that pulls out all MOS processing stops: 4-micrometer channel length (compared to 6 μm for products on MOS chips), a gate-oxide thickness of less than 1,000 angstroms (compared to 1,200 angstroms), and arsenic-doped junctions of less than 1 μm. (Many semiconductor specialists feel these parameters are about the limit obtainable with present production-line photolithographic methods).

When this scaled-down cell geometry is applied to Intel's substrate-biased static RAM designs (2115 and 2125 types), it results in single 5-volt devices with typical access times of 45 ns, active power dissipation of 500 milliwatts, and standby power dissipation of 35 milliwatts.

The new 2147 4,096-bit MOS statics fit on a die measuring only 25,000 mil<sup>2</sup>, about the same size as proposed 4-k bipolar RAMs but with considerably less power dissipation.



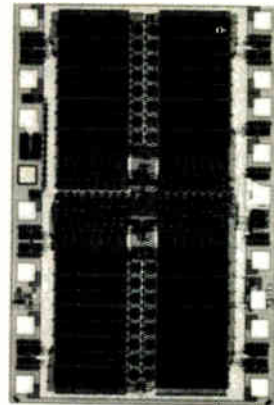
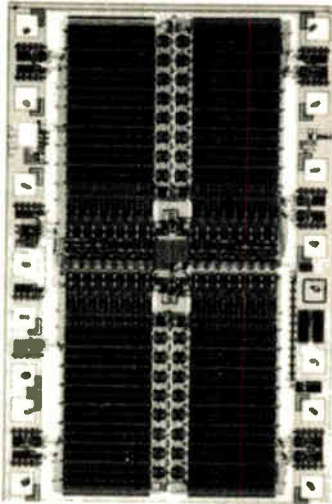
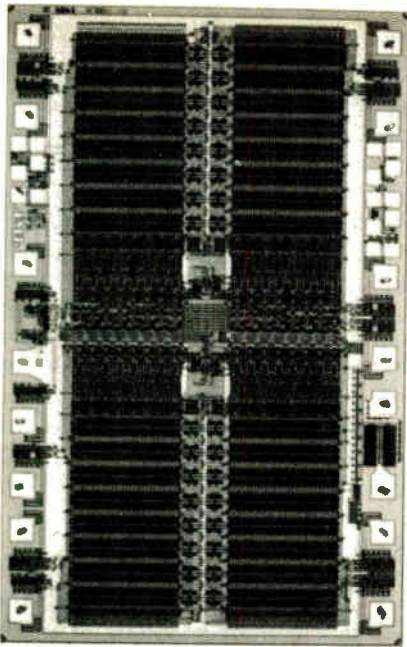

**V-MOS power.** AMI's soon-to-be available S4015 1-k static RAM, left, has access time of 45 ns on 10,000-mil<sup>2</sup> die. Versions to come—with 35 ns on 6,900 mil<sup>2</sup>, middle, and 28 ns on 4,400 mil<sup>2</sup>, right—indicate performance potential of V-MOS technique.

In memory fabrication, die size determines production costs for a given process. So the Intel MOS devices, in volume production, could for the first time provide an extremely competitive cost-performance alternative to bipolar RAMs for buffer systems.

The firm will not disclose its production schedule for the 2147; some industry sources say it is already in sample production. In any case, the company generally saves its most impressive design disclosures for the ISSCC and has rarely disclosed the details of a device it did not build within the year.

**V-MOS RAM.** Just as impressive are the V-MOS RAM techniques developed at AMI. According to T. J. Rodgers, director of the firm's static program, applying the technique to a 1,024-bit static device results in extremely impressive performance, even when the chip uses relaxed 6- $\mu$ m rules. The 5-v 1-k part, AMI's S4015, will have a typical access time of 45 ns and a chip about 10,000 mil<sup>2</sup>, or about as large as the best oxide-isolated walled-emitter TTL 1-k RAMs from Fairchild. It will be ready for sampling in May or June.

More important in gauging the V-MOS impact on RAM designs is the scaling data Rodgers has made available. Shrunk versions of the 4015, built with 5- $\mu$ m rules, would

operate typically at 35 ns on 6,900-mil<sup>2</sup> dice. With the 4- $\mu$ m rules, a 1-k 4015 would operate at 28 ns and occupy only 4,400 mil<sup>2</sup>. Such scaling also holds for 4,096-bit designs, where most of the MOS and bipolar competition will unfold. Using current 6- $\mu$ m rules, a V-MOS 4-k part would fit on a chip less than 22,000 mil<sup>2</sup>, with 45-ns typical access times. When shrunk, the 4-k static chip would attain 35 ns and measure about 15,000 mil<sup>2</sup>—considerably less than either Intel's disclosed 4- $\mu$ m part or an equivalent bipolar 4-k design.

Of course, Fairchild is not sitting still over its bipolar process, which dominates the high-speed memory market. Recently, the company

shrank its entire line of 1-k parts about 30%, while lowering access times to the 35-ns range. It has ready samples of a 4-k design (TTL and emitter-coupled-logic versions) that should stand up well under the MOS attack.

Thomas Longo, vice president and director of research for Fairchild Camera and Instrument Corp., Mountain View, Calif., says the 93470 and 93471 4-k TTL parts, scheduled for sampling next quarter, have typical access times in the 30-to-35-ns range and fit on chip areas of 23,500 mil<sup>2</sup>. An ECL version scheduled for the third quarter will have 25-ns typical access times. Shrunk versions of the 4-k parts will fit on 21,000-mil<sup>2</sup> chips. □

## Commercial

### Depositors balk at funds—transfer services, forcing banks to modify their system plans

A funny thing happened to electronic funds transfer systems on the way to the bank—depositors decided that they prefer to hang onto their present check-writing procedures, thank you. This resistance has caused bankers to modify their dreams of a national computerized communications network that would

convert all transactions from paper to electronic signals triggered by plastic cards.

"Usage of most EFT systems [initiated by banks or bank consortiums] has ranged from minimal to nonexistent," says Robert L. Kramer, president of Actionfacts Inc., a New York research firm. Banks

have failed to get customers to use pre-authorized check transactions, payment of department-store purchases from the point of sale, and plastic "debit" cards, rather than credit cards.

Just what types of programs and hardware savings and commercial banks will actually use were outlined in an interim report to President Carter last week by the 27-member National Committee on Electronic Fund Transfers at the completion of its first year of intensive study. EFT is not dead, but the concept has been toned down by consumer resistance to radical changes and by the high cost of converting to paper-less credit and debit, not to mention the myriad problems of standardizing procedures and regulating the whole network. Also, fears that the present check-handling system would founder under a wave of paper, estimated at some 27 billion checks last year, proved to have been exaggerated.

**Balkers.** Why have consumers balked at electronic money? Speaking to a recent meeting of mutual savings banks' operations managers, Verne S. Atwater, president of Central Savings Bank of New York and a member of the EFT commission, said the two major concerns have been loss of control over personal funds and loss of privacy in managing them. Atwater has proposed that the commission recommend a "consumers' EFT code" that would specify the respective rights and responsibilities of the consumer and financial institutions in the use of plastic cards, direct payroll deposits, and pre-authorized payments. The code would cover liability for a lost card, stop-payment procedures, and other measures for consumer protection.

But despite EFT setbacks, the commission will include some important EFT successes when it submits its final report in October, Atwater says. For example, consumer acceptance of cash-dispensing machines and automated teller terminals is now widespread, and hardware manufacturers are marketing them hard. As one sales manager observes, "The EFT commission has already done

one good thing by forcing us to focus on what is practical. Most of the glamorous things, such as automatic exchange among banks, have failed because they were good for the banks, not the users."

Concurring with this view, market researcher Robert L. Kramer adds, "Such failures are not worthless, for the industry has learned from them." Among these pioneering misfires have been the California Scope project for interbank exchange, the Hempstead Bank of Long Island's Instant Transaction point-of-sale store hookup, and Seattle First's attempt at marketing a telephone transfer system—all now either discontinued or greatly modified.

Hardware manufacturers, such as

IBM, NCR, Mosler Safe Co., and TRW, agree with bankers, however, that EFT systems have a future, even though the pace of their adoption has been greatly slowed. Besides the cash-dispensing and automated teller machines there have been other successes. The direct deposit of Social Security payments is catching on; by last summer, about 14% of all Social Security recipients were having their payments sent directly to their bank accounts.

Moreover, as high as 10% of the work force in some states participates in direct-payroll-deposit programs. Both consumers and merchants have accepted bank systems that review deposits and guarantee check payments at the point of sale. □

---

## Microprocessors

---

### Texas Instruments and Motorola pare down microprocessors for lower-range market

With an eye toward the medium- and low-performance range of the microprocessor market, Texas Instruments Inc. and Motorola Inc. are readying devices that will pare minimum system requirements to two chips, rather than the five or more now needed. What's more, for the low-end controller market both firms are talking about year-end availability of single-chip microcomputers that will retain software compatibility with their existing flagship microprocessors: the 16-bit TMS9900 for TI and Motorola's 8-bit MC6800.

These new entrants are intended to compete in the burgeoning byte-oriented market that falls just below the multichip high performance microprocessor families such as Intel Corp.'s new 8085 [*Electronics*, Dec. 9, p. 31], Motorola's 6800 and Rockwell's PPS-8. They will compete with other two-chip systems already on the market such as the F-8 from Fairchild and Rockwell's PPS-8/2 [*Electronics*, Sept. 16 p. 52].

Texas Instruments started offering samples of its TMS9980 last month. While internal operations

match that of the 9900, the firm has gone to an 8-bit bus to drive down costs. "The 16 bits of data have to be multiplexed in, but that saves us enough pins to use a 40-pin package," says Edwin S. Huber, microprocessor marketing manager at the firm's Houston facility. Forty pins, instead of the 9900's 64, allow use of plastic packages "that will give the 9980 a two-to-one cost advantage over the 9900," he says. The company plans to sample the part in the second quarter.

Besides the processor, the new 9980 includes an on-chip clock, and users will be able to strip even more cost out of the system when a companion chip comes along in the third quarter. Designated the TMS9972, it will incorporate 2,048-by-8 bits of read-only memory, 128-by-8 bits of random access memory, and input/output circuitry.

"We anticipate the customer will be able to build a complete system for a cost equal to or less than that of an 8080 system," Huber says. But he emphasizes differences that keep the systems from head-on competition. While TI is retaining the full

## NOBODY CAN BEAT FAIRCHILD AT THE NUMBERS GAME.

Fairchild's Optoelectronics Division builds more LED digits than anybody else. Bigger digits than anybody else. Brighter digits than anybody else. And we can even fit more character size in a smaller package than anybody else. In short, we know digits.



Our digits are available with pins or as PC board mounted stackables. And, you get a choice of common anode or common cathode varieties.

Our digits also come in the widest selection of colors available. Red. Super Red. Orange. Green.

### A WORD ABOUT DIGIT TECHNOLOGY.

Our patented light pipe construction yields the industry's most efficient LED display. The result: A bigger, brighter digit. Lower cost. Lower voltage requirement. A way to outspec your competition.

### LET THERE BE LIGHT.

Whatever your digital display need — industrial, consumer or automotive, you should light up our switchboard first. Because with high volume production of digits, LED lamps, phototransistors, couplers, arrays and LED dice,

nobody has more experience or better technology than Fairchild.

For more information, write or call your

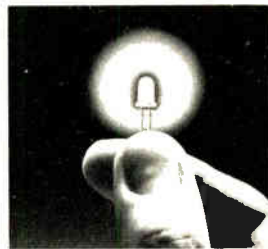

Fairchild sales office, distributor or representative today. Or use the direct line at the bottom of this ad. Fairchild Camera & Instrument (U.K.) Ltd., Kingmaker House, Station Road, New Barnet, Herts EN5 1NX, England, Phone:00-441-440-7311. TELEX:00-51-262835.

**FAIRCHILD**

**CALL US ON IT.  
00-441-440-7311**

## Electronics review

3-megahertz operation of the 9900, some operations—such as high-speed interrupt handling or moving blocks of data—will be slower because of the multiplexing.

But the instruction set of the 9980, with high-speed multiply and divide and the ability to perform multiple-bit shifts, will edge it into higher performance applications. "It will be especially good for those cost-conscious 8-bit applications that need some high numerical precision, such as numerical-control or process-control systems," Huber says.

Motorola has taken a similar partitioning approach on chips that will be available in samples later this month. Besides the registers and accumulators of the MC6800, the new MC6802 will contain an on-chip clock oscillator and driver and 128 bytes of RAM, says Colin Crook, group operations manager for micro products in Austin, Texas. The MC6802 is matched with the custom MC6846, giving the two-chip system 2,048 by 8 bits of mask-programmable ROM and an 8-bit bidirectional data port. The second chip also has a 16-bit programmable timer, unloading some of the processor's responsibility for interrupt timing and counting functions.

Further down the low-end spectrum are the firms' one-chip microcomputers. Both are reluctant to discuss details of the devices. "Unlike new Intel on-chip offerings, ours will be totally compatible with the rest of 6800 family," Motorola's Crook says. Texas Instruments, too, is aiming for such compatibility. □

### Packaging & production

## Rails, wedges keep pc cards very cool

Photocircuits' proprietary technique for achieving high-density wiring on printed-circuit boards has been employed primarily as an alternative to multilayer pc boards. However, with some modification, the so-called multiwired boards can also significantly increase power dissipation,

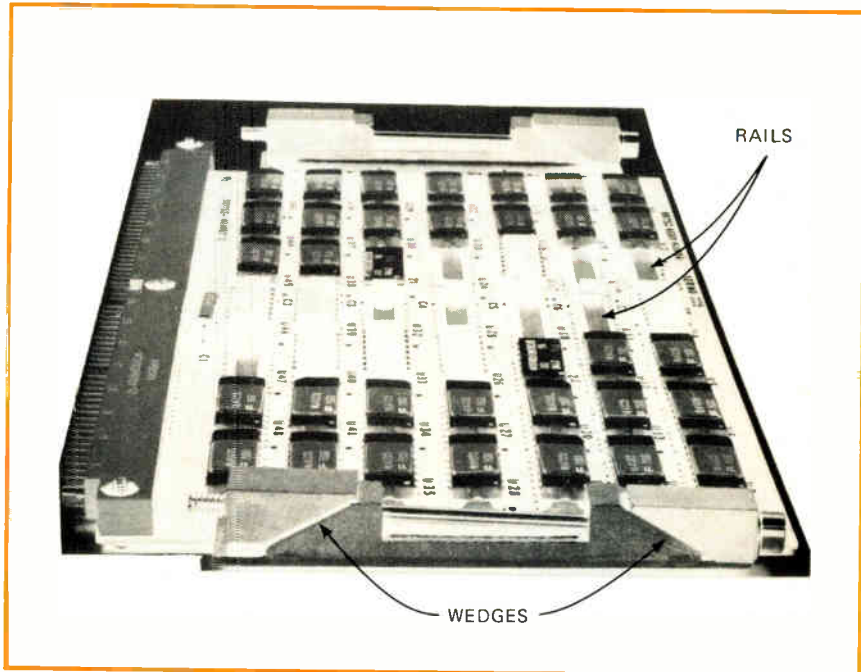

**Cooler.** Rails and wedges added by AIL division of Cutler-Hammer conduct heat more efficiently from multiwired circuit boards in B-1 avionics.

say thermal-design specialists now checking out the defensive-electronics package for the B-1 bomber at AIL division of Cutler Hammer Inc., Deer Park, N.Y.

The package incorporates high-speed logic circuits. By adding heat sinks to the boards and improving heat-transfer techniques, the designers have boosted heat dissipation until it is five to eight times as high as from conventional pc boards. In the process, the engineers are thermally controlling some 70 "black boxes," or line-replaceable units, which cover a broad range of power dissipations and environmental conditions. Dissipation per box, placed at locations in the bomber where the maximum temperature varies from 160°F to 265°F, starts at 8 watts and reaches 150 w.

**Short lead time.** One of the most compelling reasons for using the modified multiwired circuit boards is the ability to design and fabricate them in relatively short order. The lead time for heat-sunk multilayer boards would have been much too long, especially when it came to making modifications suggested by flight-test results, explains Pete Ingrassia, AIL's section head for me-

chanical design on the B-1 project.

The multiwired boards are fabricated at the Glen Cove, N.Y., facility of the Photocircuits division of Kollmorgen Corp. There, special machines lay a matrix of insulated wires on an adhesive-coated glass-epoxy board. In component density, it is equivalent to a multilayer board.

Power dissipation is boosted by adding heat-sink rails along with special mounting wedges (see photograph above). These wedges, in turn, transfer heat to the main heat sink of each line-replaceable unit. This sink is an oil-cooled chill plate, assembled with a special fluxless brazing technique to prevent long-term corrosion.

The rails, made of aluminum, or, for higher power dissipation, copper, are riveted onto each pc board. They bear directly against the bottom surface of the dual in-line packages mounted on the board. This contact transfers heat more efficiently than can a conventional pc board, which has a gap of 20 to 60 mils between the DIP and the board.

With heat-sink rails alone, a 4-by-7-inch board could dissipate 5 to 7 w. However, the thermal wedges raise power dissipation of the card to 24 w, points out Ken Garcia, AIL's



are anxious to  
see you **in Paris**  
when you visit the  
salon international des  
**composants**  
**électroniques 77**

We will be  
at home  
in the

**Holiday Inn**<sup>®</sup>  
**HOTEL** Paris/Porte de Versailles 73,  
Boulevard Victor, 75015 Paris. Telephone (1)533 74 63.

March 31–  
April 6, 1977

**General Instrument challenge you to play the newest, most exciting TV games.**

You saw our ball and paddle game microcircuits in 1976. Now you can test your skill and be absorbed for hours with our new 1977 TV games.

Or you may prefer to try out **our newest TV tuner microcircuits**. You can tune a TV by remote control and display the channel, time and tuning scale on the screen.

**There's an electronic piano you must play to believe.** Our new microcircuits would convince even Beethoven.

**You can also tune a Hi-Fi by remote control** while you relax with a soothing drink (it's the only non-electronic thing there).

And when you are ready to leave, there is a remarkable digital clock to tell you the exact time.

**Come see what's new from the G. I. microcircuit people.**

**GENERAL INSTRUMENT  
MICROELECTRONICS LTD**

57/61 Mortimer Street, London, W1N 7TD  
Tel: 01-636 2022 Telex: 23272



in-house consultant on thermal design. He predicts that this kind of board design is "the future circuit card for high-speed logic applications with their high power-dissipation requirements." □

---

**Communications**

---

## Carrier asks to set up Motorola system

American Radio-Telephone Service Inc., a regional radio common carrier in Baltimore, has asked the Federal Communications Commission for permission to establish a cellular mobile-radiotelephone service in the Baltimore-Washington area. ARTS is proposing a three-phase 24-month, \$2.5 million program for a system operating between 800 and 900 megahertz to cover 1,500 square miles. The carrier is relying on technology and equipment from Motorola Inc.

The FCC is also reconsidering a request by AT&T's Illinois Bell Telephone, rejected last year, to build a similar system in the Chicago area—Motorola's headquarters. A cellular system divides a geographic area into hexagonal units and places antennas at alternate corners of each hexagon. The antennas broadcast signals to mobile users, who are handed off from one cell to the next as they drive through the system [*Electronics*, Jan. 3, 1972, p. 100].

**Markets.** Beyond the ARTS system, which Motorola calls Dynatac, for dynamic adaptive total area coverage, Motorola expects its investment in developing cellular mobile technology to run between \$18 million and \$19 million. Starting five years ago, Motorola submitted two technical proposals to the FCC for cellular telephone systems in accordance with the commission's Docket 18262 that makes available the so-called 900-MHz region for land-mobile service in the 800-to-900-MHz band. Since then, it has also applied for experimental licenses in both Chicago and New York which were never acted upon. Now, how-

ever, Motorola says it will only supply common carriers.

If ARTS fails to obtain FCC approval, Motorola will consider developing its concept outside the United States, says Martin L. Cooper, a vice president and the general manager of the Communications Systems division, Schaumburg, Ill.

The Motorola system is compatible with Illinois Bell's approach. Both companies specify channel spacings of 30 kilohertz, with Bell coming down from an earlier 40 kHz and Motorola moving up from 25 kHz, according to Cooper. The system for ARTS will operate at 838.75 to 845 MHz and 883.75 to 890 MHz.

ARTS will use seven towers with a total of 55 transceiver base stations and antennas. Frequencies will be reused every 19 and 38 miles from

the towers. The system will demonstrate cell hand-off and vehicle-location techniques, as well as the capacity to "grow gracefully by employing reuse," the FCC was told. Seven of the transceivers will be used for signalling the mobile units digitally, the other 48 will handle the conversations.

In the first year and a quarter, the ARTS system will report on propagation factors and vehicle location and direction required for hand-off. Later, the complete hardware and software will be installed and tested with as many as 1,000 users. The system could handle up to 32,000 subscribers within a 12.5-MHz band, Motorola says, but this could be ultimately expanded to 129,000. Cooper says hand-held units will cost about \$2,000; units mounted in vehicles about \$200 less. □

---

**Components**

---

## TI readies 50¢ temperature sensor for automotive applications

Aiming squarely at automakers, Texas Instruments has developed a low-cost temperature sensor that dramatically improves the linearity and response time of the firm's Sensistor line of positive-temperature-coefficient silicon thermistors. The use of standard semiconductor manufacturing techniques pushes its price down much lower, to about 50 cents each, depending on tolerance.

TI intends its sensor for ambient temperature sensing in automobiles, both under the hood and in the passenger compartment. It described the device for the first time this week at the Society of Automotive Engineers' annual meeting in Detroit.

**Many uses.** "It will be inexpensive enough to go into almost any adjustable-thermostat application," says Bryan Zimmerman, who heads new-product development for the firm's Silicon Small Signal department in Dallas.

The TSP 102, as it is called, relies on a spreading-resistance phenomenon that is the basis of a TI patent

application. An n-type silicon substrate is covered with a double dielectric layer of nitride and oxide. Dopants are diffused through a hole placed photolithographically in both dielectric layers. These dopants help form an ohmic contact, instead of a junction between the silicon and an aluminum bonding pad.

"Where the Sensistor is nothing more than a bar of n-doped silicon with metalized contacts on either end, this one is built with the standard planar process," Zimmerman says, "The current applied to the relatively small, precisely dimensioned contact spreads through the silicon to the vacuum-deposited gold base of the chip, which provides the second contact. The resistance of the device is controlled to a large degree by the contact size, instead of the bulk resistance of the silicon—and it's easier to control the size of the hole than the size of the bar."

In contrast, the resistance of a Sensistor is determined by the physical dimensions of the bar. Assembly

New option from the Powerhouse ...

# RCA 2N3055.

# Now pay less and still get more.

RCA gives you a new choice in Power Transistors. The 2N3055H is the industry's original homotaxial workhorse. It still offers unique RCA features. And it still sports the ultimate in SOA characterization.

The 2N3055 is our new epitaxial version of the homotaxial "H". It lets you trade in a little SOA for a lower price. Without having to trade in all the features that made RCA the leading choice in 2N3055's in the first place.

The RCA epitaxial version still offers you more than other similarly priced 2N3055's.

What extras do you get? Rugged steel headers (they give you aluminum). Clip-lead connectors (they give you wire bonds). Plus real-time process controls.

The RCA epitaxial - homotaxial option is available in three voltages. And if your choice is epitaxial you can have complementary pairs at all three levels.

They're all available now from your local

#### Buy as much SOA as you need.

NPN	PNP	V <sub>ceo</sub>	SOA	Beta	1K Price
RCS617	RCS618	80	2.87A@40V	20-70@5A	0.88
2N3055	MJ2955	60	2.87A@40V	20-70@4A	0.55
2N6569	2N6594	40	2.87A@40V	15-200@4A	0.50
2N6254		80	1.87A@80V	20-70@5A	1.20
2N3055H		60	1.95A@60V	20-70@4A	0.95
2N6253		45	2.55A@45V	20-150@3A	0.55

\*Optional distribution resale price U.S. only.

RCA Distributor or Representative. Or send for complete data.

Write: RCA Solid State, Box 3200, Somerville, NJ 08876; Sunbury-on-Thames, Middlesex TW16 7HW, England; Ste.-Anne-de-Bellevue, Quebec, Canada; Fuji Bldg., Tokyo, Japan.

**RCA Power experience is working for you.**

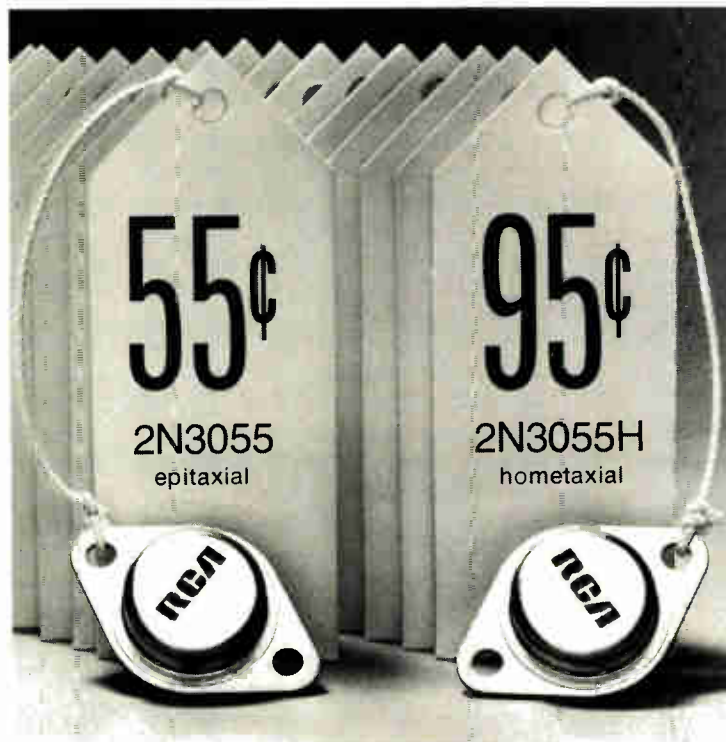

# RCA

# LSI-11 Micro- computer Data Acquisition System

The ADAC Model 600-LSI-11 is the first data acquisition system available for use with the DEC LSI-11/PDP-11/03 microcomputers.

Both software and hardware compatible, the Model 600-LSI-11 A/D system plugs directly into the bus of the LSI-11/PDP-11/03 systems.

Features include a 12 bit A/D converter, high speed sample and hold circuit, from 16 to 64 channels of MUX., DC/DC power converter and bus interfacing. A/D system throughput rate is 35 KHz.

Optionally available are: one or two 12 bit D/As and programmable gain amplifier with auto zeroing circuit.

Send for full technical data on the Model 600-LSI-11 and other ADAC minicomputer data acquisition and control systems and modules.

ADAC Corporation,  
15 Cummings Park, Woburn,  
MA 01801. (617) 935-6668.

Telephone: England—0273-720716,  
Germany—89-594621, Switzerland—  
01628200, Scandinavia—01124803,  
Japan—5915241, France—95022.24,  
Holland—076-1222555

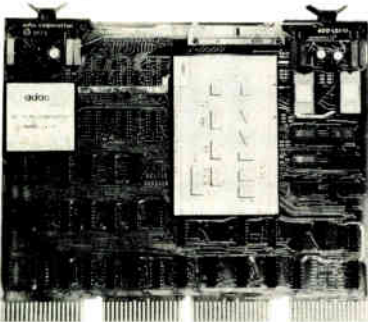

**adac**

corporation

## Electronics review

### News briefs

#### FCC gets request for interactive educational broadcasting

The Federal Communications Commission is considering a petition to establish a community radio service dedicated to education, one that would allow interaction between participants in different locations. Cosponsored by the Center for Advanced Study in Education of the City University of New York and a group called the Communicasting Association of America, Syosset, N.Y., the petition asks for 84 megahertz of spectrum space in the 470-to-930-MHz range of the land-mobile radio service bands. Preferred are the ultrahigh-frequency television channels 70 through 83 (806 to 890 MHz). The cost of equipment for this region would be two orders of magnitude less than for the instructional television fixed service in the 2.5-to-2.69-gigahertz band, says S. Edwin Piller, Communicasting Association's president.

#### Rockwell consolidates MOS LSI efforts

Rockwell International Corp.'s delay in entering n-channel MOS LSI production may have been one factor that prompted its latest reorganization. LSI activities have been consolidated in a single Electronic Devices division, headed by Howard D. Walrath, who came from Rockwell's Collins Radio group. Walrath's bailiwick includes the old Microelectronic Devices division, which handles Rockwell's microprocessor and other LSI activities, plus additions such as MOS LSI modem subsystems and filters from Collins, special devices from Autonetics group, and segments of hybrid microelectronics from both Collins and Autonetics. Also, the Autonetics' Electronics Research division, renamed the Electronics Research Center, is assigned to Walrath, who will be based in Dallas. He says it is too early to comment on n-channel plans. Charles V. Kovac, former general manager of Microelectronic Devices, who becomes division vice president for business development, reports to Walrath.

#### New dielectric fluid replacing PCBs

General Electric Co. has developed a new dielectric fluid for its power capacitors that it is substituting for polychlorinated biphenyls, cited as environmentally harmful. The company will stop using PCBs entirely after June 30. The new fluid, called Dielektrol, is biodegradable, says GE's Capacitor Products department, Hudson Falls, N.Y.

is a tedious manual process of sawing it, etching it to a precise cross section, and metalizing the ends.

**1% tolerance.** The linearity of the spreading-resistance principle allows T1 to specify the device's 1,000-ohm nominal resistance to tolerances as tight as 1%, though tolerances as loose as 20% are planned. The firm eventually wants to offer a range of resistances from 500 ohms to 5 kilohms. Temperature coefficient of resistance is about 0.7%/°C.

The TSP 102, offered in a plastic TO-92 package, also responds quickly to changes in temperature. Its thermal time constant is roughly 1.5 seconds, compared to 35 seconds for the Sensistor family. It is also faster and cheaper than the wirewound-nickel bobbin-type sensors Detroit now uses. □

## Automotive

### Ford's vendor plans beyond 1978 unclear

Ford Motor Co. may have chosen vendors for its engine-control electronics beginning with the 1978 models, but it will be later this year before it is clear exactly what they will supply for 1979 cars and beyond. And it is possible that Ford will reopen the bidding for the more advanced engine-control modules that it would like to use beginning with 1980 cars.

"Obviously, all existing suppliers will be considered part of the supply source for the total engine control modules in the 1980-1981 time



# GENERATOR SYNTHESIZER AND FREQUENCY SYNTHESIZER

3300/3310  
**300 Hz**  
**60 MHz**



## MODEL 3300, PROGRAMMABLE GENERATOR SYNTHESIZER

The output frequency is set by eight rotary switches providing 1-Hz resolution. The output level is adjustable from +20 dBm to -130 dBm by a 140-dB attenuator (10-dB steps) and two fine/coarse verniers, whose +3 dB to -10 dB adjustment is displayed on a galvanometer graduated in  $V_{rms}$  and dBm.

Both AM and FM can be achieved, either internally by four audio frequencies, or externally by any signal whose frequency ranges from DC to 150 kHz in AM and from DC to 70 kHz in FM. A pushbutton permits the display of AM depth or FM deviation on the meter. The instrument features seven Search or FM deviation ranges, from  $\pm 1$  Hz to  $\pm 1$  MHz, with continuous variation of the output frequency inside each range.

## MODEL 3310, SYSTEM-ORIENTED SYNTHESIZER

In this fully programmable instrument, nine digits determine the synthesizer output frequency with 0.1-Hz resolution, while the output level ranges from +20 dBm to -79.9 dBm with 0.1-dB resolution (+19.9 dBm to -79.9 dBm in local mode).

A programmable switch allows to change the ALC time constant in order to obtain very fast level switching.

These two instruments distinguish themselves by the following characteristics :

- 50  $\Omega$  or 75  $\Omega$  output impedance
- Phase noise in a 1-Hz bandwidth close to the carrier 110 dB down and harmonic signals 40 dB down.
- $\pm 0.3$  dB output level flatness over the whole frequency range.
- $\pm 5.10^{-9}$ /24 h frequency stability.

**so let ADRET guide you to the**

**right frequency synthesizers** ; circle our number on the reader service card, return the coupon or write us on your letterhead. We'll rush you our new 1977 catalog. It gives you a lot of practical tips about frequency measurements as well as the details on our hardware.

Circle 41 on reader service card



12 avenue Vladimir Komarov  
78190 Trappes • France  
Tél. 051.29.72  
Télex ADREL TRAPS 600 821

World Radio History

Name : \_\_\_\_\_ Title : \_\_\_\_\_  
Firm : \_\_\_\_\_ Phone : \_\_\_\_\_  
Address : \_\_\_\_\_  
City : \_\_\_\_\_ State : \_\_\_\_\_  
Country : \_\_\_\_\_

# Direct Synthesis: 0.1-160MHz

Model 5600 Direct Frequency Synthesizer, Fully Programmable.

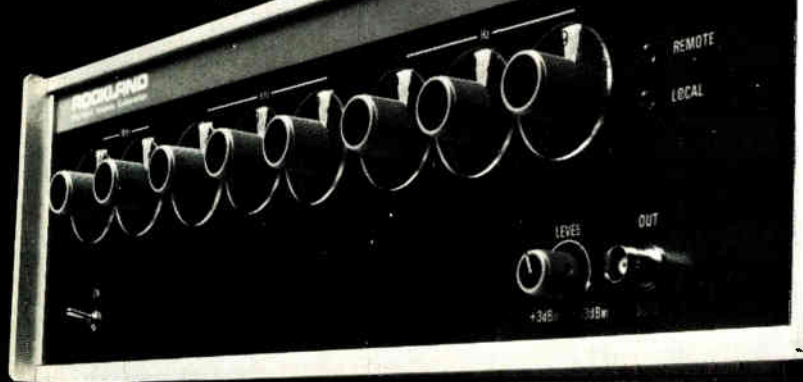

## Anybody out there interested in getting more synthesizer performance for less money?

You get significantly better performance, over a much wider applications range, with the new Rockland Model 5600 Frequency Synthesizer. And you get it for nearly a thousand bucks less (U.S.A.) than any other synthesizer in this class.

Why? Because we've built a true *direct* synthesizer that actually costs *less* than the conventional phase-locked-loop types. Direct synthesis means: orders of magnitude faster switching; greater spectral purity; minimal switch-transients; and lower noise.

While we were at it, we polished some other parameters and added a few extra features: flatter leveling; higher stability; *constant* resolution (*no* range multipliers, *no* band switching); external-DC amplitude programming; an auxiliary buffered output; and a gated buffer register on the remote digital frequency programming inputs (simplifies computer-bus interfacing).

Check these specs: a *single* 0.1 to 160MHz frequency range, with *constant* 1Hz resolution; maximum switching time, 20 microseconds (that's 50-100 times faster than the phase-locked clunkers!); -70dB spurious (that's

10 to 15dB better); -35dB harmonic spurs (that's 6 to 10dB better); -70dB phase noise;  $\pm 0.5$ dB leveling (2:1 better); and  $2 \times 10^{-9}$ /day stability (with built-in crystal reference).

What's your application? Satellite communications? HF systems? Spectrum analysis? Radar? Frequency-Agile systems? ATE? Manual filter/network/circuit testing? Or do you just want a great laboratory frequency standard? For all of those, and many more, the Model 5600 is the best value... and the best choice.

HOW AND WHY direct synthesis - Rockland style - is superior technique for digital frequency control is explained in this free data file.

To get one, use the inquiry number, call, or write.

Rockland Systems Corporation  
230 W. Nyack Road  
W. Nyack, N.Y. 10994  
TEL: (914) 623-6666  
TWX: 710-575-2631



ADVANCED SIGNAL TECHNOLOGY  
**ROCKLAND**  
SYNTHESIS • PROCESSING • ANALYSIS

Our Second Decade of Leadership

Circle 42 on reader service card [World Radio History](#)

## Electronics review

frame," says Robert S. Oswald, manager of electronic engine controls at Ford's Dearborn, Mich., engine engineering office. The suppliers are Tokyo Shibaura Electric Co. (Toshiba), the Essex group of United Technologies Corp., and Ford's Electrical and Electronics division [*Electronics*, Feb. 17, p. 26].

**Others a question.** "We haven't made up our minds whether we will allow other people to bid on the 1980 system," Oswald continues. "We are concerned about the amount of resources in the vendor arena we're tying up on one product." Several automotive-systems suppliers, including Eaton Corp., Motorola Inc., and Bendix Corp. are still actively working on proposals.

Motorola, through its Automotive Products division, reportedly is developing a system based on a custom microprocessor with 10-bit instructions and 8-bit data bus. Bendix is designing its module with a standard MC6800 Motorola microprocessor.

Ford also has to decide whether its three systems suppliers will be allowed to use their own module designs or assemble a single module design from identical, but second-sourced, components. For 1978-model-year engine modules, with ignition-timing and exhaust-gas-recirculation (EGR) control, production has started using a set of nine integrated circuits, including a 12-bit processor, supplied by Toshiba. "But EED (Ford's Electrical and Electronics division) and Essex will be manufacturing those devices as soon as they can launch their semiconductor manufacturing plans," Oswald says.

For 1979 cars, Toshiba is repartitioning its system into six chips. Ford will decide in the third quarter whether Essex and EED, which contracted with Texas Instruments Inc. and Intel Corp. for semiconductors, will implement its own designs. In the 1980 model year, fuel management will be added to the repertoire handled by Ford's electronic controls. By then, "as the processor's speed increases, an 8-bit system will clearly be capable of doing our job," Oswald says. □



## Intel delivers resident PL/M for the Intellec<sup>®</sup> Microcomputer Development System. Say goodbye to monthly computer bills.

Now Intel has a resident PL/M compiler available with the Intellec microcomputer development system. Resident PL/M can give you a competitive edge because it can drastically cut your software development time and help you get new products to market quicker.

Having PL/M resident on the Intellec system means the end of monthly computer time sharing bills too. And eliminates delays waiting for computer availability. It makes it easier than ever to take advantage of a high level programming language.

You can lease an Intellec system for \$610\* a month with ICE-80,<sup>™</sup> dual diskette drives,

CRT terminal, line printer and resident PL/M compiler.

Or if you already own an Intellec system you can add resident PL/M for \$975\* Once. Not monthly.

That gives you everything you'll need for fast, reliable programming of Intel<sup>®</sup> 8080 or 8085 microcomputers or our SBC-80 Single Board Computers and System 80 packaged microcomputer systems.

Under the new Intellec ISIS-II diskette operating system, PL/M provides the capability for fully modular programming. This means that programs can be developed and debugged in small, manageable modules,

and easily linked together, or linked with general purpose sub-routines from a software library. And because the Intellec system supports your total development task, you save the cost and inconvenience of separate systems for hardware and software development and systems integration.

Intel offers PL/M workshops throughout Europe and Japan. Contact Intel International, Brussels, Belgium. Telephone: (02) 660 30 10, Telex: 24814, or Intel Japan, Tokyo, Telephone: (03) 426-9261, Telex: 781-28426.

**intel<sup>®</sup> delivers.**

\*Domestic U.S.A. prices only.

Circle 43 for technical information  
World Radio History

Circle 190 for technical information and a demonstration

# The bigger recorder choice:

The new Philips recorder range features these four X-Y models plus six stripchart instruments: all designed for maximum operator convenience. For example, the new A4 format recorders have a recess for a roll chart as well as employing standard, single sheets and thereby give a better, all-round X-Y/t performance. And all stripchart X-t models feature the Z-fold chart paper system that's easy to change, easy to examine and ideal for note taking.

Operator convenience is, of course, just one of the many reasons why more and more engineers are choosing Philips instruments for their recording needs. A choice that is helped by the wide range of model types and options, so that needs and budgets always balance out.

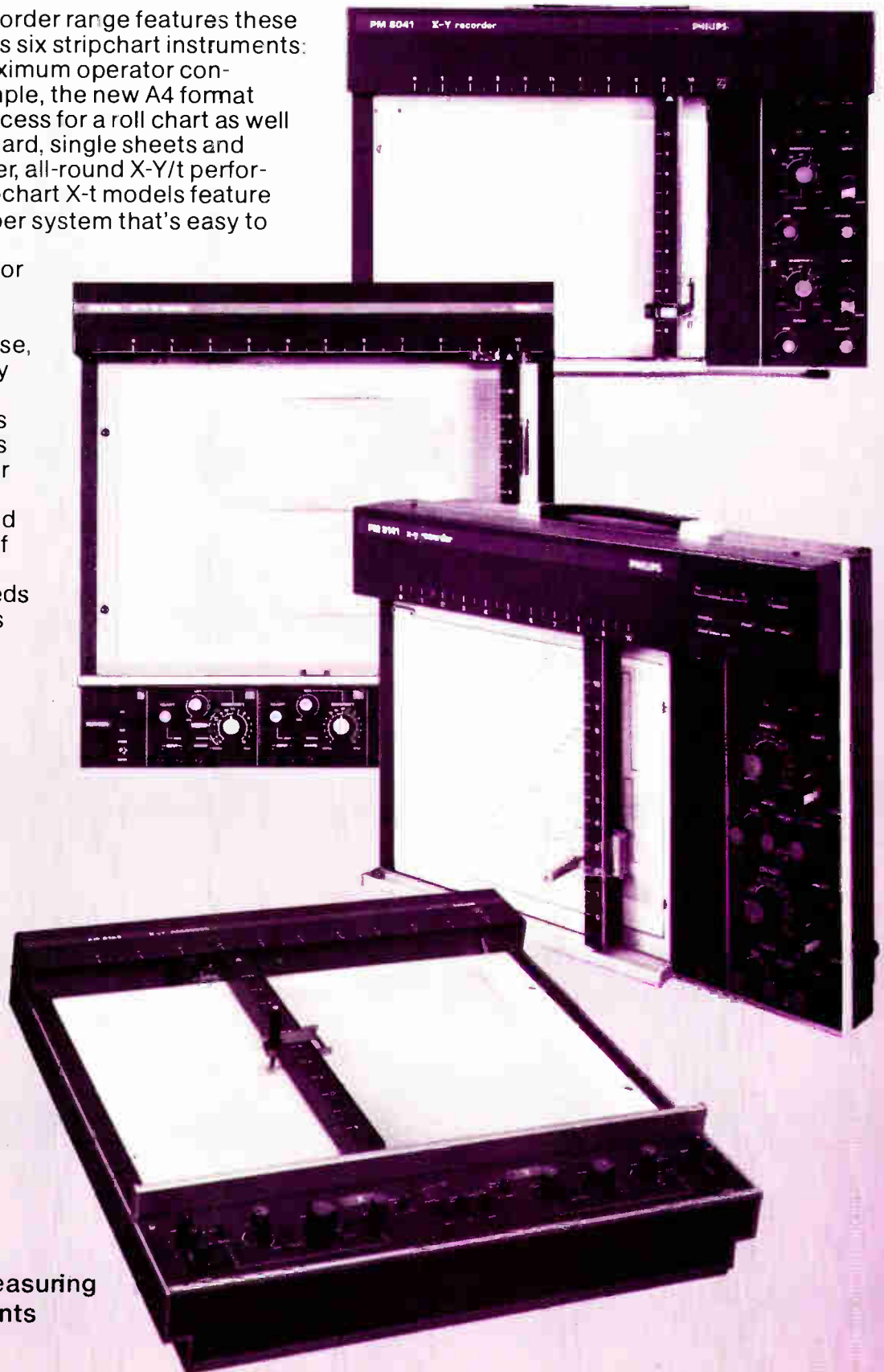

Test & Measuring  
Instruments

# in X-Y, X-Y/t and X-t

## A ten-model choice plus a wide range of options to match your individual needs

### Versatile X-Y/t performance in A4 formats

Both Philips A4 format X-Y recorders can be optionally fitted with an automatic, plug-in timebase, giving sweep speeds from 0.5 to 10 s/cm. This facility is extended by the provision for a roll chart paper system. Both models have excellent stray voltage rejection plus a switchable noise filter.

Model **PM 8041** has nine input ranges from 2 mV to 1 V/cm, a high writing speed of 75 cm/s and gives accurate, reliable performance in an economic manner.

Model **PM 8141** has an excellent, all-round specification with 14 ranges from 50  $\mu$ V to 1 V/cm and zero point adjustment from -400 to +105% of span.

### Higher resolutions in A3: single- and double-pen

Again Philips offer a two-model choice. The **PM 8125** single-pen recorder provides 14 calibrated ranges from 50  $\mu$ V to 1 V/cm; a 50 cm/s writing speed and zero setting from -20 to +120% of span. The optional timebase gives sweep speeds from 0.05 to 20 s/cm depending on the range selected.

Double-pen model **PM 8132** gives versatile X-Y performance with an excellent specification that includes 15 ranges from 200  $\mu$ V to 10 V/cm; a high 60 cm/s writing speed and zero setting from -100 to +100% of span. The automatic X-axis timebase is standard on this model and includes six speeds and remote control.

*The six model stripchart, X-t range features four compact recorders that are ideal for bench stacking or rack mounting, plus a mini model PM 8110, shown here on the modular, multipoint recorder PM 8235*

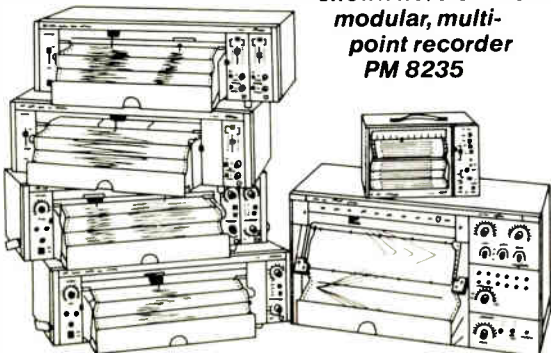

### When a trend tells more

Most measurements can benefit from the hindsight of a visible record. Many cry out for an analog interpretation of a confusing array of digits. The only problem used to be the recording cost, but not anymore.

Mini-recorder **PM 8110** weighs in at a mere 3 kg and has a matching price. It has a go-anywhere performance that exceeds its small size and a 120 mm recording width, which is a useful 20 mm more than you'll usually find.

**PM 8110** also features input sensitivities from 10 mV to 10 V, a response time of 0.5 s, accuracy of 1% fsd and an optional battery pack.

### Compacts for convenience

All four Philips 250 mm single- and double-pen recorders feature a compact construction that is ideal for crowded bench tops, for instrument stacking and for OEM mounting. Additionally they all feature the Philips Z-fold chart paper system that combines the best of two recording worlds. For note taking in the 'flat-bed' style the chart table projects forward; for easy chart changing and for examining the trace(s) along the entire 20 m length, the chart folds up into a convenient stack.

Single- and double-pen models **PM 8251** and **PM 8252** are designed for all-round performance. The multi-

range input modules have 12 calibrated steps from 10 mV to 50 V and chart speeds from 0.5 to 30 cm/min. Response time is 0.6 s fsd. Special chart speed, 1 mV sensitivity and single-range options are available on request for OEM applications.

A somewhat wider range of features is offered by models **PM 8202** and **PM 8222**. Input modules can be multi- or fixed-range with sensitivities from 1 mV to 50 V. Modules are also available for temperature measurements. Chart speeds can be selected from 3 to 6,000 cm/hr in 11 steps; response time is a high 0.25 s for 250 mm and a wide range of options is available, including remote control.

### Multipoint recording

In addition, the Philips programme includes the **PM 8235**, a modular, multipoint recorder having 0.25% accuracy and 0.1% reproducibility. This instrument gives a free choice of 1 to 12 point recording through simple, pin-board programming and has an adjustable 1 to 20 s printing interval time. A six-range programmable unit is available for mV, thermocouple or thermal resistor.

Get the full facts on the bigger recorder choice. Tick the reader service number, fill in the coupon or contact your local Philips office.

Please send me full details on:

- X-Y recorders                       X-t recorders  
 The whole range                       Model PM .....  
 All Philips Test and Measuring Instruments

Name .....

Department .....

Company ..... Phone .....

Address .....

City ..... Country .....

Post to: Philips Industries, Test and Measuring Instruments  
Dept., TQ III-2, Eindhoven, The Netherlands.

# PHILIPS

Circle 192 on reader service card

# Who

# Oosh!

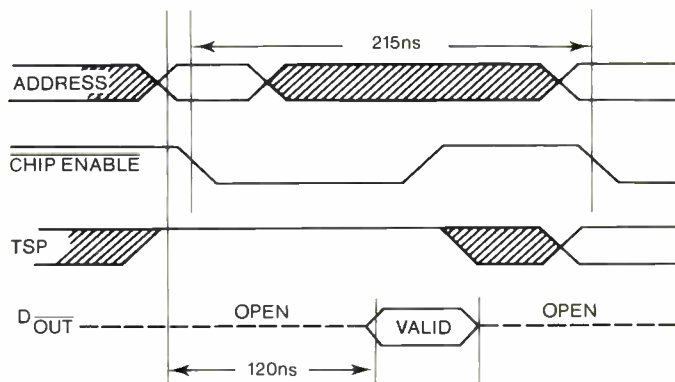

**4K MOS RAM**

Here we go again.

Another in a string of lickety-split RAMs from National.

MM5271A 18-pin 4K Dynamic RAM with TTL-compatible chip enable.

It's the fastest TTL-compatible 4K MOS RAM on the market. A blistering access time of 120 ns. And that's including on chip level conversion. Cycle time is 215 ns. at the same power dissipation as older 4K dynamic RAMs.

An equally fast 22-pin version also available (MM5281A). As are versions without clock driver 18-pin (MM5270A), 22-pin (MM5280A).

So get your pen.

Quick.

National Semiconductor GmbH	E33
808 Fuerstenfeldbruck	
Industriestrasse 10	
West Germany	
Gentlemen:	
Please send me further information about:	
<input type="checkbox"/> MM5271A <input type="checkbox"/> MM5281A <input type="checkbox"/> MM5270A <input type="checkbox"/> MM5280A	
Name _____	
Company _____	
Address _____	
City _____	State _____ Zip _____

 **National Semiconductor**

# Microprocessor controlled counters

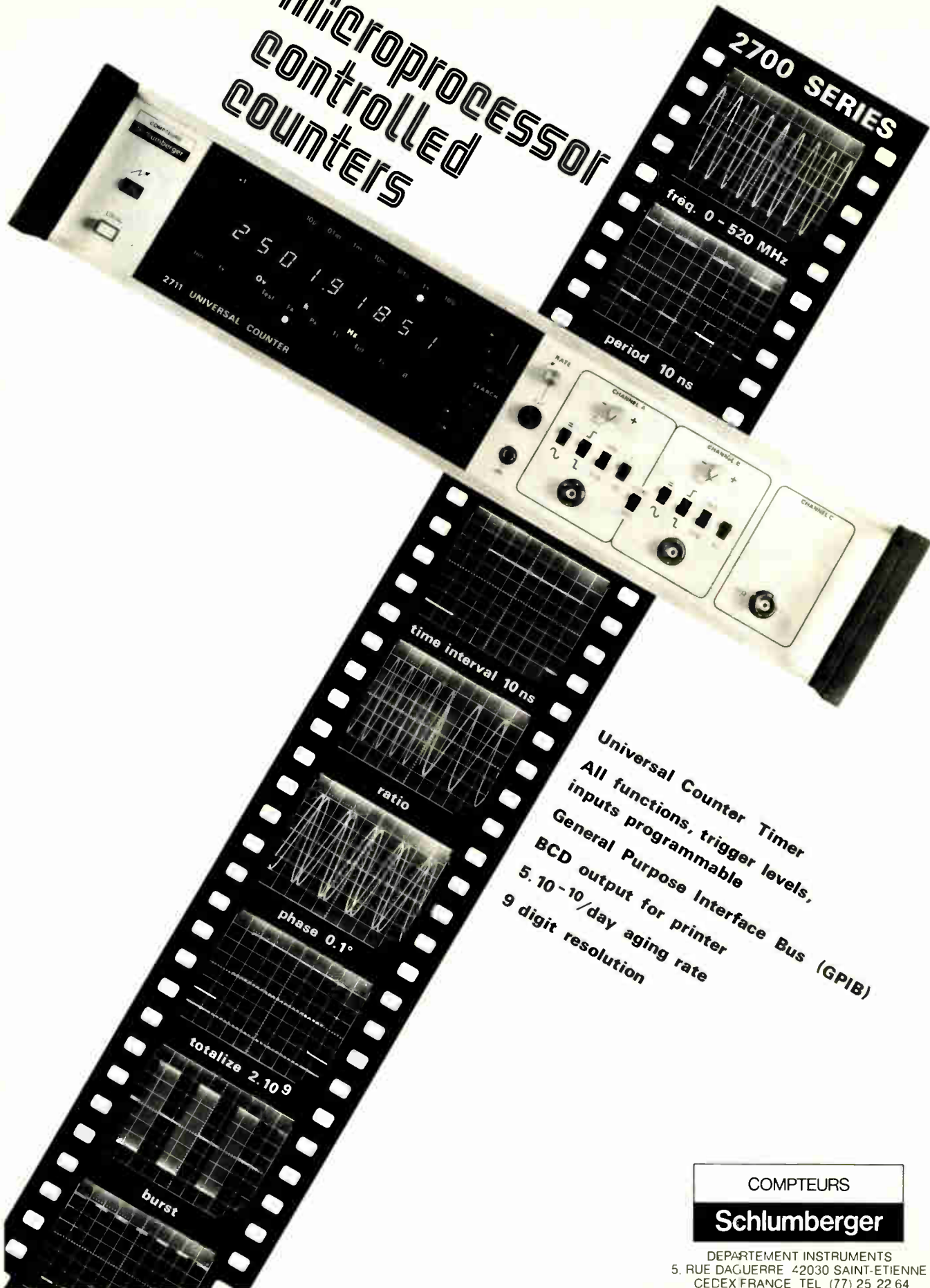

Universal Counter Timer  
All functions, trigger levels,  
inputs programmable  
General Purpose Interface Bus (GPIB)  
BCD output for printer  
5.10-10/day aging rate  
9 digit resolution

COMPTEURS

**Schlumberger**

DEPARTEMENT INSTRUMENTS  
5, RUE DAGUERRE 42030 SAINT-ETIENNE  
CEDEX FRANCE TEL (77) 25 22 64



## **Electric-vehicle demonstration funded for \$40 million . . .**

The Energy Research and Development Administration won and lost some electronics-oriented money with President Carter's amendments to Gerald Ford's last budget. ERDA officials are delighted with the \$40 million proposed to start its electric-vehicle demonstration program [*Electronics*, Feb. 17, p. 47], which was not in the budget.

But the ERDA officials are downcast at the **loss of all but \$10 million of the \$65 million proposed in January to build a pilot 10-megawatt solar electric power plant** [*Electronics*, Feb. 3, p. 80]. A reshuffling of other ERDA monies to accelerate solar thermal programs supports the view of agency sources that the Carter energy proposals are oriented toward programs with a quick payoff.

## **. . . NASA gets money for Landsat-D spare, Mars studies**

The National Aeronautics and Space Administration picked up \$15 million more in budget authority, including \$12 million to be spent in fiscal 1978, **as the Carter proposals raised the agency's budget slightly**. Of the total, \$5 million will be used to start procurement of a backup satellite for the Landsat-D earth resources spacecraft, a buy that will require \$60 million over six years. NASA also got \$10 million for studies of alternative Mars follow-on missions in the 1980s.

## **Amateurs hit FCC on proposed ban of rf amplifiers**

Amateur radio operators are in an uproar about two new Federal Communications Commission proposals to require type acceptance of all amateur transmitters and amplifiers and to ban marketing of external rf amplifiers capable of operating from 24 to 35 megahertz. The stricter rules are **aimed at preventing the extensive illegal use with citizens' band radios of high-power external amplifiers**, which interfere with legitimate CB operations and with radio and television reception.

**Amateur operators contend they are being unduly penalized for violations caused by only a handful of CB operators.** FCC chairman Richard Wiley, who concurred in the 5-0 vote, agrees. "In attempting to deal with the rapidly proliferating and sometimes troublesome CB service, we may appear to be penalizing the amateur community—one of the most 'professional' and self-regulated services," he notes. Comments on the proposed ban on external amplifiers (Docket 21116) and amateur equipment type acceptance (Docket 21117) are due May 25 with reply comments by June 6.

## **DOD pushes NATO decision on Awacs; Air Force buy halved**

In a move regarded as leverage on America's NATO allies to bring about a decision on buying an uprated version of Boeing's E-3A Airborne Warning and Control System, Secretary of Defense Harold Brown has, as expected, proposed halving the Air Force 1978 buy to three planes, cutting the procurement by \$150 million, or 38%, from the requested \$393 million [*Electronics*, Feb. 3, p. 57]. **Brown wants to defer more Awacs buys until NATO acts and then upgrade the Air Force planes to achieve a superior common aircraft.** Another Brown goal is to get the Air Force moving on a common version as well as on a decision about just how many Awacs will be needed for continental air defense.

## The coming controversy over Carter's budget

After just four weeks in office, President Jimmy Carter has delivered to Congress 101 pages of proposed changes to Gerald Ford's last budget that clearly reflect Carter's desire to stimulate the national economy quickly. Overall, budget authority would rise by \$26.8 billion to \$507.3 billion, some 5.5% more than Ford sought, while Federal spending would climb by \$19.4 billion to \$459.4 billion, a 4.4% boost. For the electronics industries, specific program changes contain bits and pieces of unexpected good news for agencies like the National Space and Aeronautics Administration and the Energy Research and Development Administration (see p. 49), but much more bad news—most of it expected—at the Pentagon.

The widely heralded cut of \$2.7 billion in Ford's defense budget, for example, comes in total obligational authority, not spending. In the fiscal year beginning Oct. 1, the spending level will drop no more than \$400 million to \$109.7 billion—a figure that is still nearly 5% more than this year. But NASA gains \$15 million in budget authority under Carter's amendments, of which \$12 million will be spent next year, while ERDA will get its budget authority doubled to \$318.3 million, of which \$105 million more will be spent in 1978.

### Boosting combat readiness

Defense Secretary Harold Brown's cuts include an expected \$160 million in the funds for the development of the next-generation intercontinental ballistic missile, the Air Force M-X, deferring full-scale development another year. But that 46% cutback in funds still leaves \$134.4 million to pursue development of such electronics as a new guidance system and other components, as has been expected [*Electronics*, Feb. 3, p. 58.].

Carter's goal, apparent throughout his changes in military programs, is to improve the combat readiness of existing forces by increasing maintenance and overhauls at the expense of new systems like M-X still in development. The \$290.5 million in the existing 1977 budget to buy 60 more Minuteman III ICBMs, Brown says, "will be applied instead to components to support the existing force and maintain essential component-production capability, without further procurement of complete missiles." Similarly, Carter is increasing 1978 budgets for NATO maintenance facilities and overhauls of

ships and aircraft by \$390 million, while saving \$187 million by cancelling the nuclear strike cruiser proposed as an Aegis missile platform for fleet air defense; terminating the Navy's final buy of six A-7E Corsair II attack aircraft to save \$24 million; and killing the Army's Lance missile, which was set for a buy of 360 at a cost of \$77.5 million.

### Cutting off LTV

Congressional hackles have risen at these and other cuts. The White House is already getting heat from the Texas delegation—including House majority leader James C. Wright—on the termination of the Corsair and Lance programs. Both are products of Texas-based LTV Corp.'s Vought operation and would deal the company a serious blow as a major prime contractor. At stake are an estimated 7,000 jobs in Texas and another 1,100 in Sterling, Mich., where Vought produces Lance.

Deferrals in other areas are troubling other delegations, too. One example is the Air Force's F-15 interceptor. Slowing McDonnell Douglas' annual F-15 production to 78 planes—a reduction of 30—is expected to "save" \$334 million of the \$1.7 billion originally proposed, but Air Force officials say it will only push the unit cost up later. Another blow to McDonnell was the deferral of another \$26 million in advance procurement money for F-15s as follow-on interceptors.

### Time for more thought

But Carter and Brown are convinced they need more time to evaluate the overall weapons mix. Thus the production decision on Rockwell's B-1 bomber is being deferred now from March to June while the 1978 buy of planes is being reduced from eight to five for a \$280 million "saving." And this leads to a slowdown in the plane's Short-Range Attack Missile schedule for another \$23 million reduction. Similarly, the Army's Advanced Attack Helicopter contracted to Hughes Aircraft has been halved to \$100 million in the RDT&E budget so that Brown can make "a more thorough evaluation of options."

Consequently, the small improvements in the budgets of agencies like NASA and ERDA are likely to pass virtually unnoticed in the forthcoming congressional budget battle as the action centers around the more controversial military cutbacks.

**Ray Connolly**

# 5 REASONS WHY ... TODAY, TOMORROW WE LEAD THE PACK IN IC INTERFACE

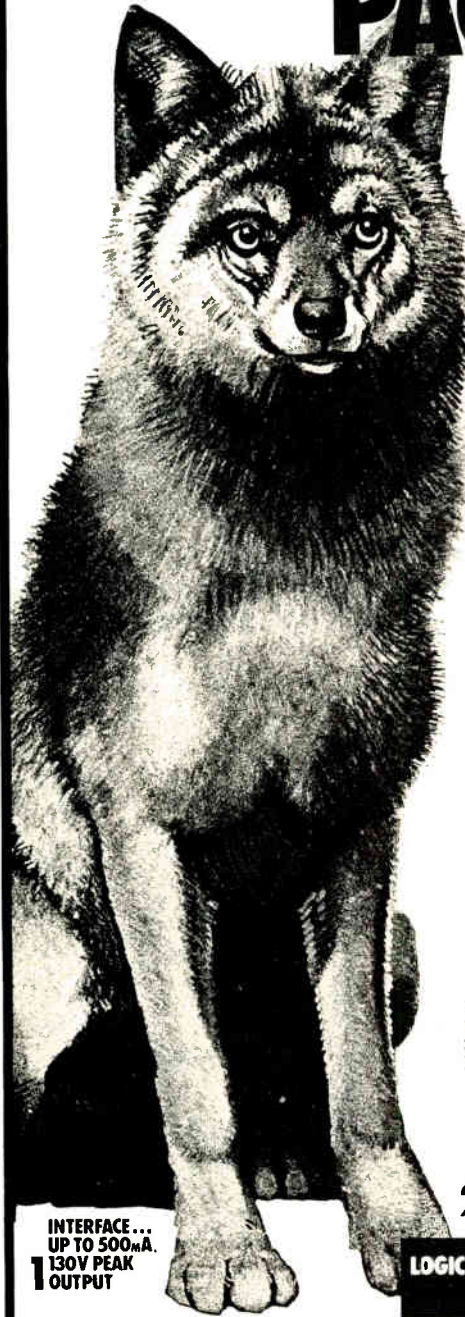

In short, SPRAGUE claims to leadership have teeth in them: we offer an ever widening IC INTERFACE programme – providing both unsurpassed logic compatibility and driving versatility. Additionally, construction is exclusively monolithic and features DIL encapsulation.

For full information, just fill-in the address patch and INTERFACE squares which correspond to your design requirements – returning the completed coupon to Sprague World Trade Corporation.



**2** 8 STAGE DARLINGTON

**3** PNP DARLINGTON

**4** 95V DARLINGTON

**5** LOW POWER SCHOTTKY TTL COMPATIBILITY

INTERFACE ...  
UP TO 500mA.  
130V PEAK  
OUTPUT

LOGIC TYPES	INDUCTIVE LOADS		POWER		DISPLAYS							
	1	2	3	4	5	1	2	3	4	5	LED	GAS DISCHARGE
DTL/TTL LOW POWER SCHOTTKY TTL	<input type="checkbox"/>	<input type="checkbox"/>	<input type="checkbox"/>	<input type="checkbox"/>	<input type="checkbox"/>	<input type="checkbox"/>	<input type="checkbox"/>	<input type="checkbox"/>	<input type="checkbox"/>	<input type="checkbox"/>	<input type="checkbox"/>	<input type="checkbox"/>
CMOS (5V)	<input type="checkbox"/>	<input type="checkbox"/>	<input type="checkbox"/>	<input type="checkbox"/>	<input type="checkbox"/>	<input type="checkbox"/>	<input type="checkbox"/>	<input type="checkbox"/>	<input type="checkbox"/>	<input type="checkbox"/>	<input type="checkbox"/>	<input type="checkbox"/>
CMOS (12-15V)	<input type="checkbox"/>	<input type="checkbox"/>	<input type="checkbox"/>	<input type="checkbox"/>	<input type="checkbox"/>	<input type="checkbox"/>	<input type="checkbox"/>	<input type="checkbox"/>	<input type="checkbox"/>	<input type="checkbox"/>	<input type="checkbox"/>	<input type="checkbox"/>
PMOS	<input type="checkbox"/>	<input type="checkbox"/>	<input type="checkbox"/>	<input type="checkbox"/>	<input type="checkbox"/>	<input type="checkbox"/>	<input type="checkbox"/>	<input type="checkbox"/>	<input type="checkbox"/>	<input type="checkbox"/>	<input type="checkbox"/>	<input type="checkbox"/>

777

NAME \_\_\_\_\_

POSITION \_\_\_\_\_

FIRM \_\_\_\_\_

ADDRESS \_\_\_\_\_



SPRAGUE WORLD TRADE CORP  
P. O. B. 195, CH-1215 GENEVA  
AIRPORT 15, SWITZERLAND

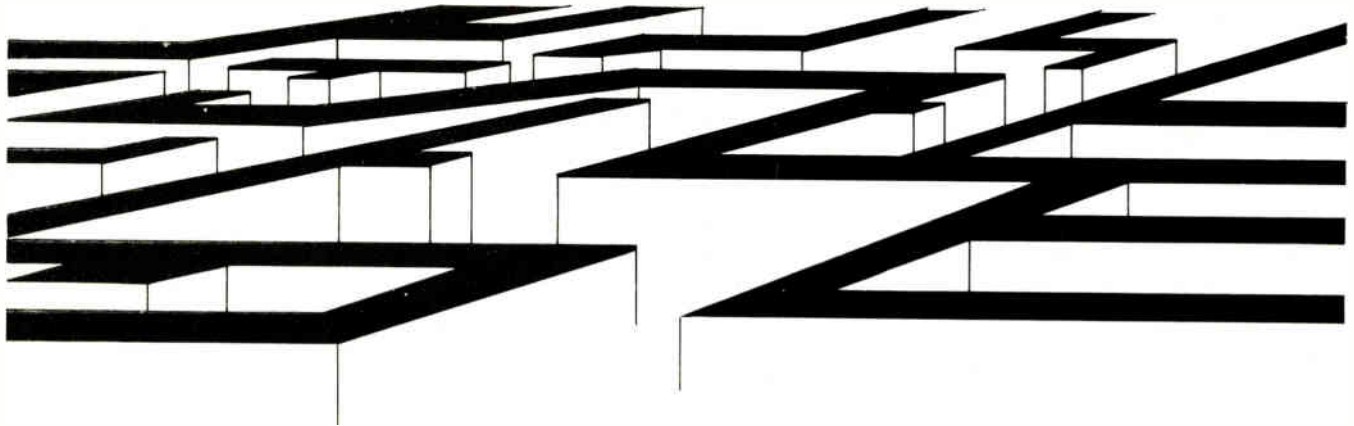

## Oscilloquartz knows at least two sensible routes through that oscillator maze

You could spend a lifetime trying to make a meaningful comparison of the many oscillators on the market today. They come in so many shapes, sizes, package configurations — not to mention specifications — that it's extremely difficult to make a reasoned choice for your particular project. Here is Oscilloquartz's answer to two specific problems:



### 1 Better Cost/Performance Ratio in a Precision Crystal Oscillator.

Confused about which precision crystal oscillator has the best performance/cost ratio for your counter, timing instrument, recorder, communications system or frequency synthesizer? Get on the right road with the Oscilloquartz B-1325

Frequency: 5 MHz or another frequency between 4 and 6 MHz  
 Aging rate:  $5 \cdot 10^{-10}$  / day  
 Stability between  $-40^{\circ}\text{C}$  to  $+55^{\circ}\text{C}$ :  $< 6 \cdot 10^{-9}$   
 Short term stability:  $\sigma_{\tau} 1 \cdot 10^{-11}$  for  $\tau \geq 1$  sec.  
 Electronic frequency control  
 Compact: 50 x 51 x 116,6 mm

oven-controlled crystal oscillator.

The B-1325 combines excellent long- and short-term stability, voltage control capability, and a rugged design to provide immunity to environmental changes... all allied to a price that will embarrass nobody.

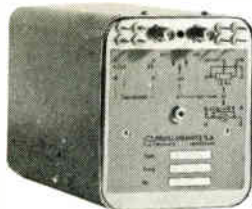
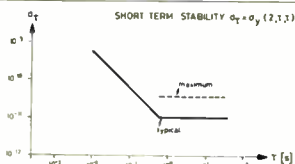

### 2 Outstanding Spectral Purity in a High Stability System.

Still trying to locate the right high stability quartz crystal oscillator for your narrow-band communications system, frequency synthesizer, coherent radar/navigation system or other application where signal multiplication to high frequencies is necessary?

Take a look at the Oscilloquartz B-5400. This 5 MHz signal source combines state-of-the-art

Frequency: 5 MHz or another frequency between 4 and 7 MHz  
 Ultimate aging rate:  $< 1 \cdot 10^{-10}$  per day  
 Short term stability:  $\leq 1 \cdot 10^{-12}$  for  $\tau = 1$  to 10s  
 Less than  $5 \cdot 10^{-10}$  frequency deviation from  $-30$  to  $+55^{\circ}\text{C}$   
 Electronic frequency control  
 Compact: 71.5 x 84 x 135 mm

short-term stability, outstanding spectral purity and long-term aging performance. And it has probably the lowest phase noise (close to the carrier) commercially available today.

External frequency control voltage of the B-5400 facilitates phase-locked operation with other signal sources in tracking receivers, atomic frequency standards, sensitive measurement systems and similar applications.

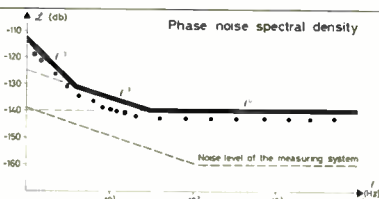

Then there's the rest of our range. It doesn't matter whether you need a modest (by our standards, that is) clock oscillator, TCXO, oven controlled oscillator or a better than  $1 \times 10^{-10}$  frequency standard, we can advise on the best trade-off between frequency performance, power consumption, volume and cost.

Member of the Ebauches group



# OSCILLOQUARTZ SA

Pathfinders in Precision

CH-2002 Neuchâtel 2 Switzerland  
 Tel. 038 25 85 01 Telex 35315

March 3, 1977

# Electronics

## International®

UK company kindles solid-state glow for car dashboards: page 3E

Delegates to the ITU World Administrative Radio Conference in Geneva plan for direct-broadcast satellite service in the 1980s: page 69



# Portable printing and plotting

## World's first 12V impact printer

### Ideal for data comm.

Operating from a 12V supply, the new mosaic printer 115DR from Philips goes anywhere that print-outs and plots are needed. Tests have been carried out with the 115DR between a central computer and vehicles and the following results were obtained.

```
@ABCDEFGH IJKLMNOPQRSTU VWXY !"#%&'<>
@ABCDEFGH IJKLMNOPQRSTU VWXY !"#%&'<>
@ABCDEFGH IJKLMNOPQRSTU VWXY !"#%&'<>
@ABCDEFGH IJKLMNOPQRSTU VWXY !"#%&'<>
@ABCDEFGH IJKLMNOPQRSTU VWXY !"#%&'<>
@ABCDEFGH IJKLMNOPQRSTU VWXY !"#%&'<>
@ABCDEFGH IJKLMNOPQRSTU VWXY !"#%&'<>
@ABCDEFGH IJKLMNOPQRSTU VWXY !"#%&'<>
@ABCDEFGH IJKLMNOPQRSTU VWXY !"#%&'<>
@ABCDEFGH IJKLMNOPQRSTU VWXY !"#%&'<>
```



This print-out and plot clearly demonstrate the high-quality performance of this 115 mm wide printer. It is therefore ideal for police, fire and similar authorities and unlike non-impact printers, the 115DR can supply an original plus two copies.

### Ideal for p-o-s

The 115DR is ideal for point-of-sale and similar applications such as invoicing and stock updating. The compact dimensions and light weight allow it to be built into your system easily and economically. Paper width can be from 60 to 115 mm to match your individual needs. For invoicing and similar applications, the printer can accept stationery up to 215 mm wide with vertical feeding and prints a line of up to 40 characters. Continuous stationery can be fed horizontally with printing down to 40 mm from the bottom.

### Ideal for...

With this impressive and unbeatable combination of features, available at a highly competitive price, the 115DR is ideal for just about any instrumentation, industrial, business or consumer application that needs a print-out or a plot or both. Drive circuitry is built-in and comprehensive design support services are available for character generation and horizontal and vertical tabulation. Printing can be left to right, right to left or both, with a printing speed of 1.2 sec max. for a full line, including carriage return. Full details from Philips Industries, Electronic Materials and Components Division, Eindhoven, The Netherlands.

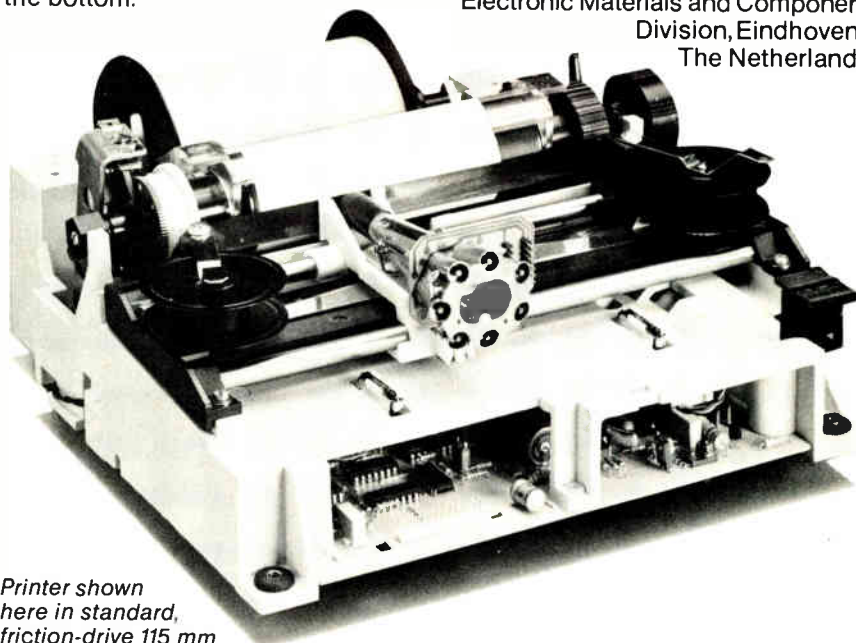

*Printer shown here in standard, friction-drive 115 mm wide form. An accessory allows sprocket driven paper to be handled up to 215 mm wide.*



Electronic Components and Materials

# PHILIPS

## **220 scientists to participate in Spacelab tests**

Some 220 scientists, more than half of them from a dozen European countries, will get involved in the experiments that will go aloft in the European Space Agency's Spacelab. Scheduled for launching aboard NASA's Space Shuttle in the second half of 1980, this first flight is intended mainly to check out the Spacelab system and the environment surrounding the shuttle. Nonetheless, 100 hours—split equally between ESA and NASA—have been earmarked for experiments during the one-week mission.

For the flight, ESA plans to arrange the Spacelab in two main sections: **a long pressurized module, where two "payload specialists" will work, and a pallet section for large telescopes, antennas, and similar apparatus.** Along with the payload specialists—one European and one American—will be three Americans in the shuttle itself.

## **Siemens introduces two subnanosecond dense ECL arrays**

Siemens AG has joined the élite group of semiconductor firms offering subnanosecond logic arrays. The West German firm has developed two high-density large-scale-integrated emitter-coupled-logic devices—master slices that provide functions ranging from basic OR/NOR gates to multiplexers, latches, and even a four-stage counter. One chip packs roughly 700 gate functions on a chip of 36 square millimeters that consumes less than 2.8 watts, and the other provides 400 gate functions on a 28-mm<sup>2</sup> chip that uses less than 2 w. Both 64-pin devices have gate delays of 0.5 nanosecond.

The company claims **chip density is four to five times higher than comparable arrays, an achievement it credits to the use of series gating and a logic swing of 400 millivolts inside each chip.** Level-shifter gates at the periphery make the chips compatible with ECL 100 K devices.

## **Commodore offers TV-game module in European market**

Commodore, a manufacturer of personal calculators in Britain, plans to begin playing for a share of the European television-game market next month with introduction of a module compatible with PAL sets at the Hanover Fair. **Based on an MOS chip from recently acquired MOS Technology Inc., the add-on module provides for games with choices of three ball speeds, five ball angles, and two levels of player competence.** Commodore, a subsidiary of Commodore Business Machines Inc., Palo Alto, Calif., may also market a cassette-loaded PAL game built around an MTI microprocessor, as well as a Teletex-Viewdata decoder.

## **Japanese firm plans computer sales in U.S., Europe**

After a successful start in the Australian market, Japan's Nippon Electric Co. is introducing its office computers and peripheral equipment in the U.S. and is planning to move into Europe. **In the U.S., it is conducting market surveys preparatory to establishing a company before midsummer** to sell its NEAC System 100E business systems, its Badminton Crown printer, its Hiprinter wire-matrix printer, and its intelligent terminals.

In Australia, NEC has already begun marketing its computers as the NEC System 100 through Honeywell Information Systems subsidiary, Honeywell Pty., which two years ago arranged to sell earlier models of the same computer as the Honeywell System 6. Already more than 100 have been ordered. Complete systems sell in Japan for \$25,000 to \$75,000. The central processing unit consists of a 16-bit microprocessor, 4-kilobit memory chips, and an interface of large-scale-integrated circuits.

## **Chip digitizes data for delta-modulated telecommunications**

Britain's Consumer Microcircuits Ltd. is marketing an adaptive delta-modulation integrated circuit built on a complementary-MOS chip for low-power applications in European military and commercial telecommunications systems. **As an encoder or decoder in the audio band, the FX309 acts as a digitizer for telecommunications, audio switching, and speech-security systems.** Needing few external components, the device is designed for syllabically companded delta-modulation systems that need good signal-to-noise performance, wide input dynamic range, and near-zero idle-channel noise. The IC, expected to sell for about \$5 in quantity, provides a preprogrammed adaptive algorithm, clock frequencies up to 64 kilohertz, and a servo-type bias signal that may be used for direct coupling.

## **TV antenna emits uniform uhf pattern to improve coverage**

An ultrahigh-frequency television antenna developed by West Germany's Rohde & Schwarz transmits highly uniform patterns, promising to improve signals in fringe areas normally plagued by poor TV reception. The antenna elements, each consisting of four specially shaped dipoles, are arranged to radiate signals in a choice of circular, semicircular, or kidney shape. **The roundness of the horizontal radiation pattern is 50% better than conventional antennas produce, R&S says.**

Other advantages include good null fill-in in the vertical pattern and a reflection factor in the TV channels of less than 2.5%. Moreover, the design enables a single system to cover the uhf range from 470 to 860 megahertz, whereas several have been needed in the past.

## **French to control railway switching with minicomputers**

The government-owned French railway system, SNCF, plans to automate many of its track switches. Last month, the switches for sidings and emergency crossovers for two 50-kilometer stretches of track—one near Tours and the other near Toulouse—went under computer control. **The two control systems, each implemented by an Intertechnique T-1600 minicomputer, are the prototypes for long-line switch automation.**

Next month, SNCF will begin full service with a three-computer system to control train movements through the Versailles zone for both suburban and long-line traffic heading into and out of Paris. A T-1600 minicomputer will set the switches to route some 600 trains a day through the junction, a second T-1600 will provide backup, and a third will handle a Tektronix graphic display. **Future systems for high-density zones will probably be patterned on the Versailles installation.**

## **LCR meter evaluates filter capacitors for power supplies**

The capability to measure equivalent series resistance at 10 kilohertz especially qualifies an inductance-capacitance-resistance meter developed in Japan to evaluate filter capacitors for switching power supplies. The model 4262A LCR meter from Yokogawa-Hewlett-Packard Ltd. also operates at the customary test frequency of 1 kHz and 120 hertz. An internal 8-bit n-channel MOS **microprocessor provides automatic initialization, prevents improper operation, enables storage and comparison of measurement results, and calculates Q from dissipation-factor measurements.** The range of equivalent series resistance, as well as that of resistance, is 1 milliohm to 19.99 megohms. The \$2,340 instrument can be connected to the HP-IB standard test-equipment interface.



# Radio communication and location

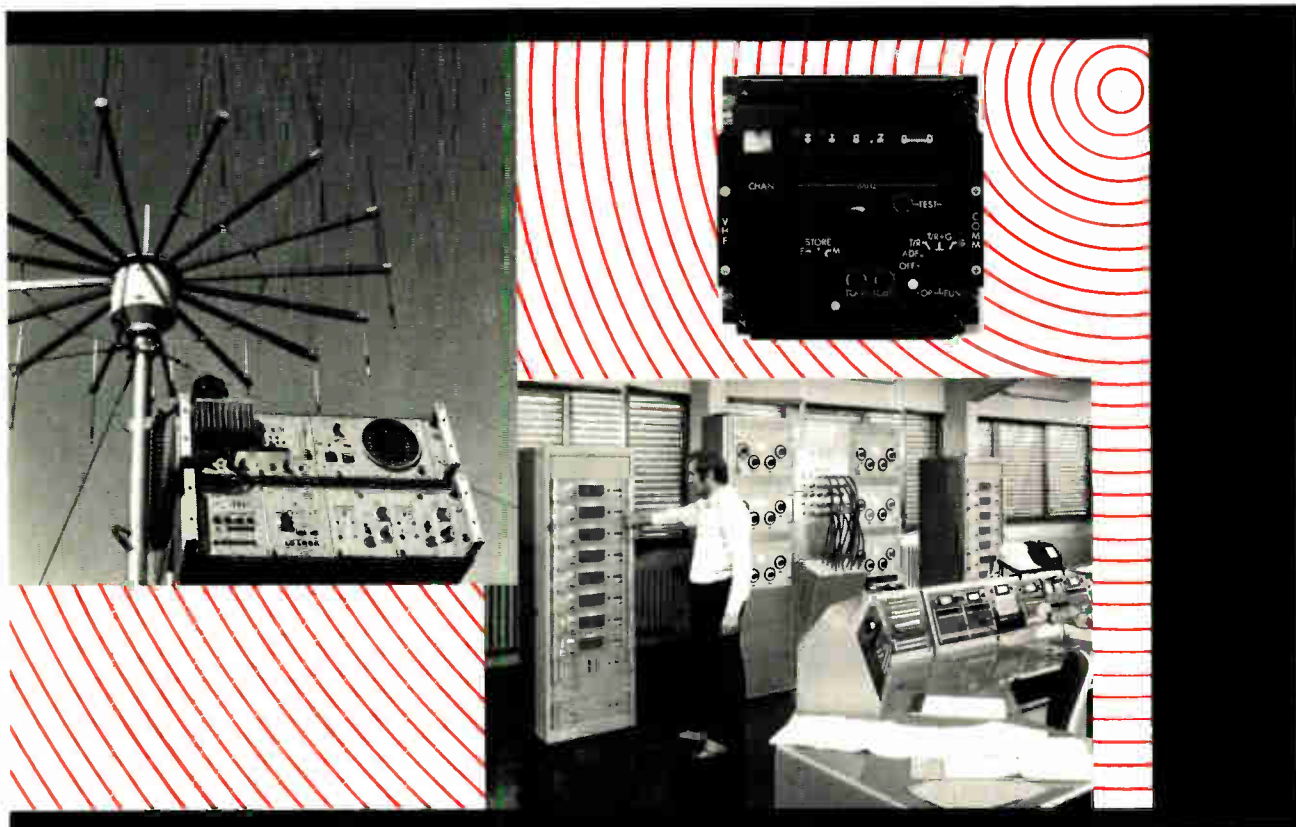

the symbol for highly qualified

## RADIOCOMMUNICATION SYSTEMS

VHF-UHF AIR-TRAFFIC CONTROL

Antennas  
Direction finders  
Receivers  
Transmitters  
Transceivers

for stationary and mobile use

**Rohde & Schwarz**  
Postfach 80 14 69  
D-8000 München 80  
Bundesrepublik Deutschland  
(Fed. Rep. of Germany)  
Telex 5 23 703 (rus d)

Electronic Measurements  
and Telecommunications:  
Development, manufacture,  
sales and service, known  
for "electronic precision"

Independent concern  
(established 1933),  
represented in 80 countries



**ROHDE & SCHWARZ**  
**RADIO COMMUNICATION**

In the matter of resistors,

# ULTRA PRECISION

for Sfernice, it is not just a word,  
it is a way of life

when we talk about precision, we don't guarantee only a few ppm in the tolerance values of our high precision resistors but, we also make sure that they have :

a very small T.C. ( $\pm 1$  ppm)  
an ultra high overall stability (5 ppm/year)  
an excellent reliability.

In order to achieve these performances, SFERNICE has built a metrology laboratory equipped with the best possible measuring gears and calibration resistors and our production facilities are manned by people for whom a dispersion of a few ppm in a batch is considered as a serious failure. This is why you'll find SFERNICE high precision resistors in (almost) every civilian or military



project where a combination of high performance, precision and reliability is a must. Moreover, our products satisfy the conditions of the specifications NF C 93 217 NFC 83220 MIL-R-39005 and MIL-R-55182/9. So, if you are involved in a project where you need real high precision resistors and if you are only satisfied with the best in reliability and performance, call SFERNICE.

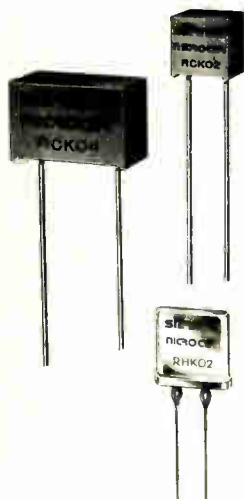

#### niROCEr PROCESSES

##### PLANAR RESISTORS

##### RCK 02 and RCK 04

0.33 W and 0.6 W at 125°C  
2.5  $\Omega$  to 300 k  $\Omega$   
Tol.  $\pm 0.005$  % to  $\pm 1$  %  
Typical T.C.  $\leq \pm 3$  ppm/°C (-55°C + 155°C)  
 $\leq \pm 1$  ppm/°C (0°C + 60°C)  
Climatic category: -55°C/+155°C/56 days

##### RHK 02

Oil filled hermetically sealed metallic case 0.25 W at 25°C  
30  $\Omega$  to 50 k  $\Omega$   
Tol. up to  $\pm 0.001$  %  
T.C. :  $\pm 1 - \pm 2 - \pm 5$  ppm/°C  
Climatic category: -55°C/+125°C/56 days



#### WIREWOUND RESISTORS

##### RAK

6 sizes 0.125 W to 0.5 W at 125°C  
5  $\Omega$  to 10 M  $\Omega$   
Tol.  $\pm 0.01$  % to  $\pm 1$  %  
T.C. :  $\pm 2 - \pm 5 - \pm 10$  ppm/°C  
Climatic category - 55°C/+155°C/56 days

##### RBK 02

Complete hermetic sealing (TO5 housing)  
0.25 W at 70°C - 100  $\Omega$  to 2 M  $\Omega$   
Tol.  $\pm 0.01$  % to  $\pm 1$  %  
T.C. :  $\pm 2 - \pm 5 - \pm 10$  ppm/°C  
Climatic category - 55°C/+155°C/56 days

##### RWK 02

Hermetically sealed  
0.2 W à 125°C - 100  $\Omega$  to 1 M  $\Omega$   
Tol.  $\pm 0.01$  % to  $\pm 1$  %  
T.C. :  $\pm 2 - \pm 5 - \pm 10$  ppm/°C  
Climatic category - 55°C/+155°C/56 days

#### QUASI STANDARD RESISTOR

##### RXK 02

Oil filled hermetically sealed metal case - 100  $\Omega$  to 1 M  $\Omega$   
Tolerance  $\pm 0.001$  %  
T.C. :  $\pm 1$  ppm/°C Shelf life 5 ppm/yr

# STERNICE

SOCIETE FRANÇAISE DE L'ELECTRO RESISTANCE

115-121 Bd de la Madeleine B.P. 17 - F 06021 NICE CEDEX Phone (93) 87.58.90 - Telex 470261

## UK firm lights glow in instrument panels for 1980-model cars

Smiths Industries chooses  
solid-state direct-current  
electroluminescence for  
gauges and warning lights

**Solid-state displays will** undoubtedly brighten future automobile dashboards. Britain's Smiths Industries Ltd. hopes to generate the first glow with a production-oriented solid-state instrument panel using direct-current electroluminescence (DCEL).

The company plans later this year to complete a DCEL module using custom integrated circuits designed jointly with Plessey Semiconductors, says Brian Shepherd, electronics director of Smiths' Vehicle Instrumentation division. The company should be sending samples to selected British and European car makers next year in time for the 1980 models. Although the conservative automobile industry customarily takes three years of lead time for new designs, Smiths expects car manufacturers to adopt the solid-state display sooner because it combines in one unit instruments, gauges, and warning lights.

**Simple.** A solid-state display has only 35 parts or processes, compared with about 430 parts of a conventional instrument panel, and information can be changed by simply redirecting the display's conductor patterns. Shepherd says that solid-state displays are more reliable, much smaller, and more versatile than conventional electromechanical instrumentation.

Besides DCEL, other technologies being pursued around the world

include electrochromic and gas-discharge panels, light-emitting diodes, and liquid-crystal displays. But Smiths chose DCEL because its inherent emission of light eliminates the need for illumination, and packaging costs are low. Shepherd says that light from a DCEL display can be made variable and does not degrade sharply.

**Versatile set.** Smiths wants to develop a set of four to eight chips—each about 0.009 inch square—so that it can have displays to serve vehicles from economy cars to luxury vehicles. Besides the driving chips, Plessey also has reconfigured a switched-mode power-supply chip from a consumer-television circuit and is designing an odometer chip of integrated injection logic; <sup>1</sup>L was chosen for the 700-gate device because it can handle "a large mass of logic with low power," explains Andrew Brittain, product-development manager at Plessey Semiconductors.

The DCEL display is based on laminar glass construction enclosing phosphor patterns. When a direct current is passed through the phosphor, the molecular layer immediately in contact with the conductive pattern emits light. This excitation is caused by pulsed dc current, which provides long life, consumes little power and stays cool. The emitted light is yellow because of the zinc-sulphide phosphors being used, but Smiths is working on other phosphors for different colors.

Though the driving circuitry is fairly straightforward, Shepherd says that the high voltage requires demand a good blend of custom-designed integrated circuits. Smiths

chose Plessey last May to help it design them, and this teamwork promises a new market for Plessey as well. Although much information about the project is still proprietary, Plessey uses a high-voltage variant of one of its standard bipolar processes obtained from lighter doping and higher junctions, Brittain says.

The high voltage is needed because the display requires about 120 volts across it, Brittain says. This potential is split evenly between the front and back plates of the display. The front plates need only one driving circuit, whereas the number needed by the back plates depends on the number of warning lights, he says. The two companies also have worked out a form of multiplexing the current-driving functions among the driving circuits to cut down the number of interconnections. □

### Japan

## Printer operates with two colors

An experimental electrostatic printer developed by Japan's Yokogawa Electric Works can print in two colors to call attention to portions of a printout or to differentiate between types of information. It uses red and black toners that pick up positive and negative charges respectively.

The toners consist of 10-micrometer-diameter particles of two separate resins that are mixed with iron particles, called carriers, 100  $\mu\text{m}$  in diameter. One resin, which acquires a positive charge

when stirred with the iron particles, contains the red pigment; the other resin, which picks up a negative charge, carries the black. The toners develop the latent image on electrostatic paper coated with a plastic dielectric layer, and heat fuses the resin to fix the image.

Pins having a potential of about 700 volts write the latent image on the paper. A positive voltage makes the image black, and a negative one makes it red. At a potential below  $\pm 400$  v, no charge is transferred from pin to paper. This threshold effect permits a matrix arrangement of resistors that minimizes the number of expensive high-voltage transistor switches needed. The resistor matrix feeds +700 v or -700 v to the desired pins and +350 v, 0 v, or -350 v to the others. The extraneous half-strength voltage does not degrade performance.

**Printing.** The machine prints lines 140 millimeters wide with a resolution of four lines per mm. The elec-

trostatic image is deposited on the paper by 560 pins across the printing head, and the paper advances 250 micrometers between the lines. For ease in fabrication, the prototype uses 560 lines on an epoxy-glass printed-circuit board, rather than true pins. The 800-v charges in the pins are switched by readily available switching transistors used in television horizontal-output circuits, even though the printer currents are much smaller than the ones the transistors were designed for. Only positive voltages are switched to the pins, and a single additional switch shifts the level for negative voltages.

A conventional switching arrangement would have required 560 of these switching transistors. But because that would have been both expensive and bulky, the resistor matrix was developed. This configuration, which handles pins in blocks of 28, limits the number of switching transistors to 20 for block selection, 28 for pin selection within the

blocks, and a single transistor to shift the voltage in order to make it negative.

**Resistors.** However, 1,120 5-megohm resistors are needed for the matrix. The experimental unit had discrete devices, but resistors will probably be printed directly on the board in the future. For compactness and convenience, the high-voltage switching circuits were built as hybrid integrated circuits.

For ease in printing the two colors, the machine actually advances the paper in 125- $\mu$ m increments, or half of the line pitch and alternates printing of the half-pitch lines in red and black. The displacement between the colors is not apparent.  $\square$

Great Britain

Two firms ready Teletext decoders

GEC Semiconductors and Mullard Ltd. are about to challenge the early lead that Texas Instruments Ltd. has won in the budding European consumer market with a Teletext decoder built around large-scale-integrated-circuit chips.

The two British companies, now canvassing television-receiver manufacturers, plan to announce their LSI decoders in time for this summer's international radio and TV exhibition in Berlin. The show is expected to be an important commercial showcase as the Continent begins to pick up Teletext broadcasting which originated in Britain [*Electronics*, Feb. 5, 1976, p. 68].

Teletext is a broadcast system that lets home viewers select "pages" of alphanumeric or graphic information for display on decoder-equipped TV sets. The pages are sent at 6.937 megabits per second during the flyback interval of the color-TV signal.

Although some expensive TV sets are equipped with decoders made with discrete components, only those made with LSI circuits make economic sense to set makers and potential customers. But designing such a

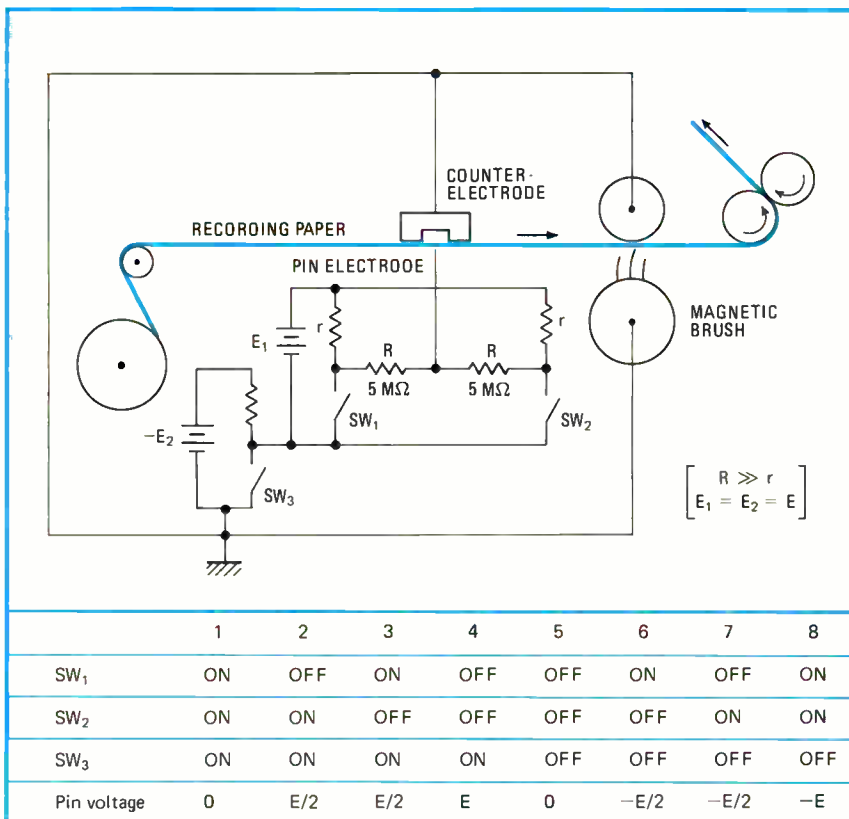

**Switching colors.** SW<sub>1</sub> is one of the 28 switches that selects pins within a block of the printer matrix, SW<sub>2</sub> is one of the 20 block selectors, and SW<sub>3</sub> determines the color by polarity. E on bottom line indicates black, -E means red, and the other two no printing.

# GO GDD



## GDDs now made in Europe

### Look at the benefits versus LEDs:

- Higher light output (approx. x10 at equivalent power)
- Lower configured costs (more digits = more savings)
- Easy multiplexing (unlike multi-digit LED displays)
- Uniform brightness
- Customised colour filtering (the result of higher light outputs and broad spectrum)

### Look also at the unique Philips plus points:

- Low profile, DIL pinning (unlike other GDDs)

- High reliability (due to rational pinning and elimination of internal connections)
- Backed by full range of decoder/driver ICs
- Local stocking and comprehensive support services



Philips is the only European manufacturer of GDDs (our shorthand for Gas Discharge Displays) and we're currently making them in dual and 1½ digit versions that are ideal for a whole host of applications.

ZM 1550 dual digit display  
ZM1551 1½ digit display

Full details including driver and reliability information on request from Philips Industries, Electronic Components and Materials Division, Eindhoven, The Netherlands.



Electronic  
Components  
and Materials

# PHILIPS

Circle 232 on reader service card

Beckman Instruments Italiana S.p.A., Via Aresè 11, 20139 Milano, Italy. Tel. 02/800001. Telex 321197  
Beckman Components GmbH, 8 München 40, Frankfurter Ring 115, Munich. Tel. No. 38871. Telex 5216197  
Beckman Instruments GmbH, Helipot Components Division, A-1197 Vienna, Sieveringerstrasse 81, Postfach 21, Austria. Tel. No. 322150. Telex 76922  
Beckman Composants S.A.R.L., 52 Chemin Des Bourdons, Gagny 93220, France. Tel. No. 9278295. Telex 691921

## BECKMAN®

**Electronics international**

circuit to find, catch, and store the desired page during the brief flyback interval is no small task. The Texas

is slated for later this year. Mullard must foresee a huge market because it will have spent about \$600,000 in

systems so that, in the future, "you can hang anything on it—Viewdata, microprocessors, etc."

**Large scale integration**

**LSI**  
**LSI**  
**LSI**  
**LSI**  
**LSI**

**Electronics Book Series**

The Electronics Book Series offers you a handbook on the current and revolutionary impact of LSI on digital design. This 220-page book presents a unique opportunity for circuit designers, systems designers, and engineering managers and supervisors to bring their expertise into line with today's LSI design requirements.

**Electronics Book Series**  
PO Box 669, Hightstown, N.J. 08520

Send me \_\_\_\_\_ copies of "Large Scale Integration" at \$9.95 per copy.  
I must be fully satisfied or you will refund full payment if the books are returned after ten day trial examination.

Payment enclosed     Bill firm     Bill me

**Credit Cards Charge My Book To**

American Express     Master Charge  
 Diners Club     BankAmericard

Acct. No. \_\_\_\_\_  
Date Card Expires \_\_\_\_\_  
Interbank No. \_\_\_\_\_  
1st No.'s. above name on Mastercharge only.

Name \_\_\_\_\_  
Title \_\_\_\_\_  
Company \_\_\_\_\_  
Street \_\_\_\_\_  
City \_\_\_\_\_  
State \_\_\_\_\_ Zip \_\_\_\_\_  
Signature \_\_\_\_\_

**Electronics IS THE SOURCE FOR BOOKS, TOO**

**McGraw-Hill**

**Electronics international**

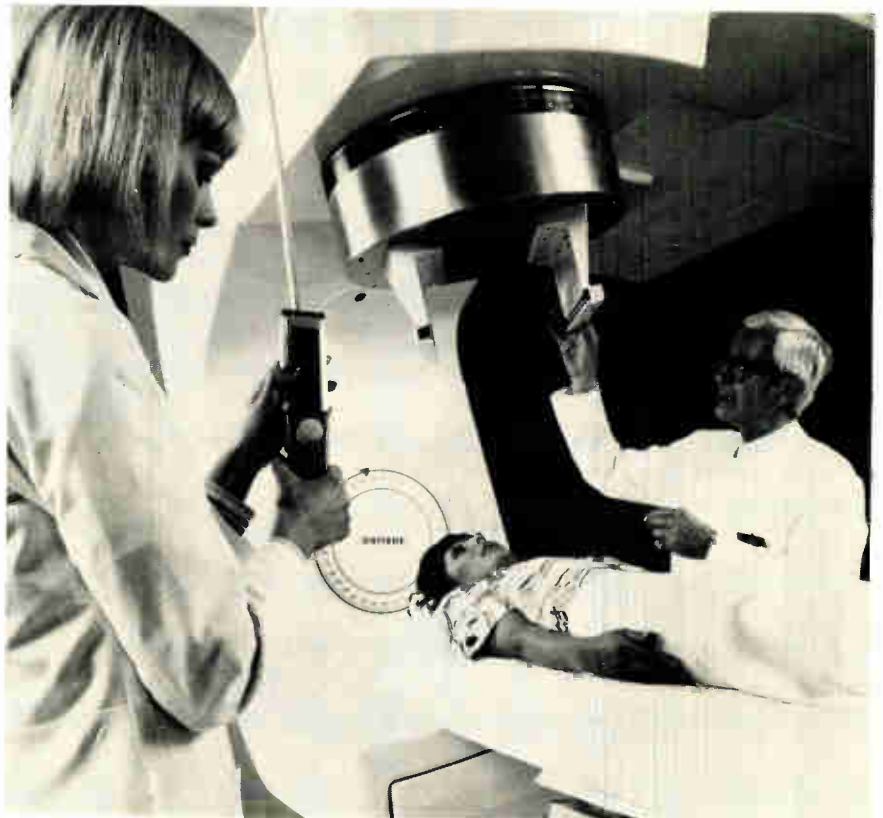

**Efficient.** The Siemens Mevatron 12 linear accelerator covers a relatively large area at a high dose rate for treatment of cancerous tumors by electron and X radiation.

radiated beam and the axis about which the equipment's radiating head swings pendulum-like over the area being treated. This value, together with the 1-m distance between the focus and the isocenter, Siemens says, provides irradiation times no longer than two minutes. □

**France**

**Motorola's stereo decoder eliminates interference by harmonic frequencies**

Since integrated-circuit phase-locked-loop stereo decoders hit the market in the early 1970s, they have become standard in most stereo radios. Meanwhile, advances in IC technology have made possible improved versions, with added features like amplifier stages and blend circuits to smooth the switch from monaural to stereo reception. Nonetheless, Motorola Semiconductor's widely second-sourced original circuit, the MC1310, still ranks as an industry standard.

But not for much longer, perhaps. Motorola has started supplying sam-

ples of a new PLL decoder that improves performance by at least a couple of notches. Developed at the company's European headquarters in Geneva, the circuit is insensitive to frequencies of 114 kilohertz and 57 kHz, which are troublemakers for European stereo reception. Motorola expects to have the chip in production by late May or early June.

"We are convinced the new 4500A decoder will be the next industry standard," maintains Ernie Pusey, director of marketing for Motorola's consumer circuits in Europe. "We were forced to design it

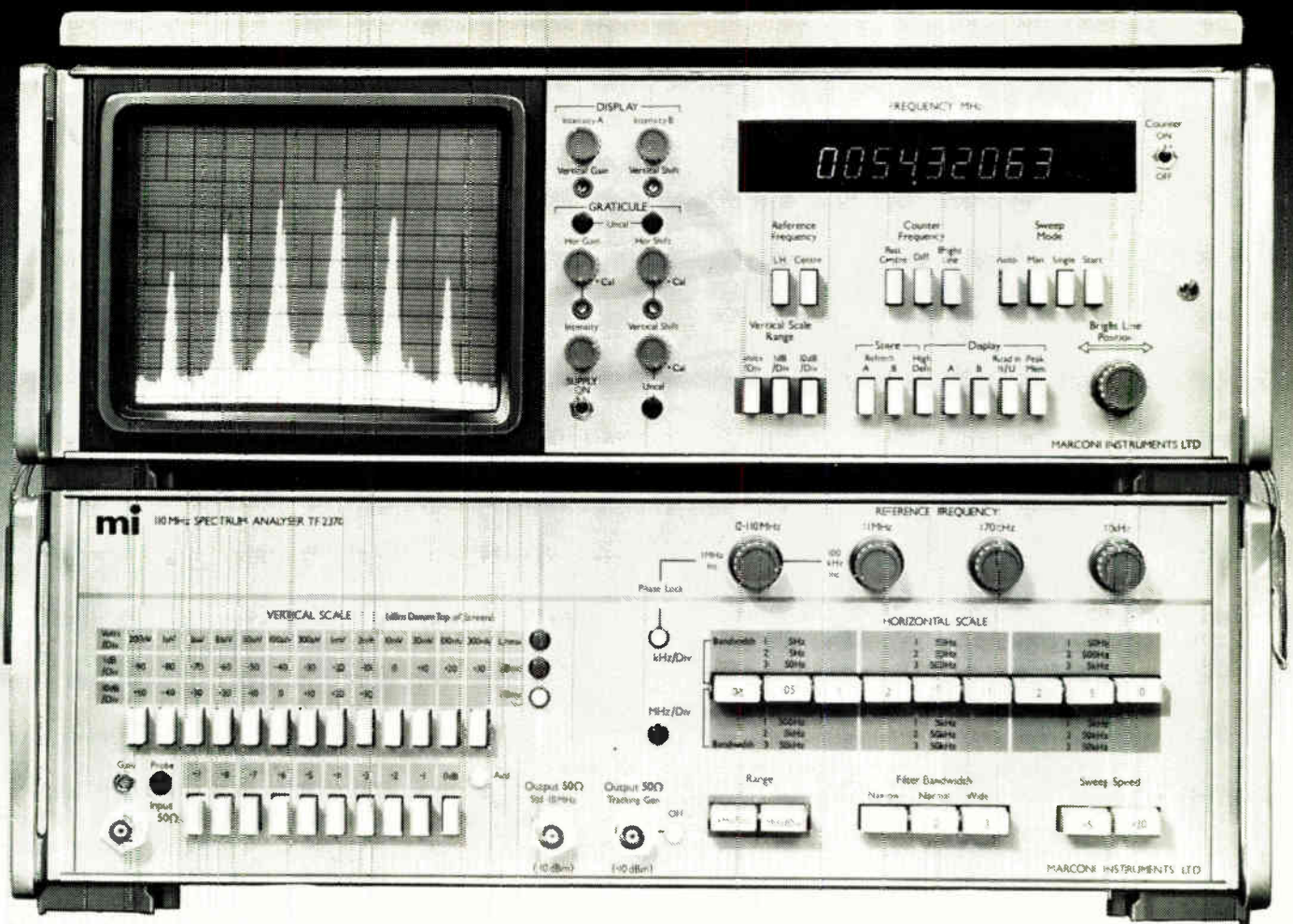

# The Most Advanced Spectrum Analyser

You've never seen a faster, more accurate way  
of measuring frequency response from 30Hz to 110MHz

The TF 2370 Spectrum Analyser employs advanced technology to provide a complete system for measuring response, level, frequency, signal purity, modulation and much more, with a speed and degree of accuracy previously unobtainable. A digital memory permits the use of a standard monitor tube and internal logic selects gain ratios and sweep speeds for optimum performance. The specification speaks for itself:

- \* Flicker-free 100 dB display of frequency response from 30 Hz to 110 MHz on a high brightness c.r.t.
- \* Electronic graticule, with a  $\pm 15\%$  variation of horizontal divisions for pin-point positioning against waveform display.
- \* Three amplitude scales: one linear and two logarithmic with expansion to 1 dB div. with an accuracy of  $\pm 0.1$  dB/dB.
- \* 9-digit electronic counter automatically gives centre frequency, reads any other frequency corresponding to manually-adjusted 'bright line' position on display, or the difference frequency between the two, at the press of a

- button. All to an accuracy of  $\pm 2\text{Hz} \pm$  reference frequency accuracy on high resolution and manual. Internal reference frequency provided with setting accuracy of 1 in  $10^7$ .
- \* Internal generator supplies synchronous signal source for measuring such items as networks and filters.
- \* For comparative measurements, unique memory storage system will retain one display indefinitely as required, for simultaneous display with response produced by items under test.
- \* Automatic adjustment of amplifier gains to give optimum lowest-noise performance with full protection against input overloading.
- \* Automatic selection of optimum sweep speed.
- \* With the 5 Hz filter, signals 100 Hz from a response at 0 dB can be measured to -70 dB.

Please send for full information or ask for a demonstration - seeing is believing! Circle 234 on reader service card

## mi: THE INNOVATORS

MARCONI INSTRUMENTS LIMITED,

Longacres, St. Albans, Hertfordshire, England, AL4 0JN. Telephone: St. Albans 59292 Telex: 23350.

A GEC-Marconi Electronics Company

# We distribute the Displays with more eye appeal.



Austria and Eastern Europe	Beckman Instruments GmbH Helipot Components Division	A-1197 Vienna, Sieveringerstrasse 81, Postfach 21
Belgium	Regulation-Measure S.p.r.L.	73 Avenue Vandriessche, 1150 Brussels
Denmark	Transcan Electric ApS	Rungstedvej 20, DK-2970 Horsholm
Finland	Oy Honeywell AB	Ruukintie 8, SF-02320 Espoo 32
France	Beckman Composants SARL	52 Chemin Des Bourdons, Gagny 93220
Germany (West)	Beckman Components GmbH	8 Munich 40, Frankfurter Ring 115, Munich
Israel	Eastronics Limited	11 Rozanis Street, Tel-Baruch, P.O. Box 39300, Tel Aviv 69018
Italy	Beckman Instruments Italiana SpA	Via Arese 11, 20159 Milan
Norway	Hefro Teknisk A/S	Postboks 6596, Rodelokka, Oslo 5
Portugal	Eltec Electronica Com. e Ind. Ltd.	Avenida Almirante Reis, 30-2° Floor, Lisbon
South Africa	Beckman Instruments (Pty.) Ltd.	Temple House, 59-61 Buitenkant Street, Cape Town.
Spain	Aeromarine and Electronics Intl. SA	Avda P10 XII Madrid 16
Sweden	AB Nordqvist and Berg	Box 9145, Bergsunds Strand 37, S-102 72 Stockholm
Switzerland	Megex Electronic AG	Industriezone Nord, 8902 Urdorf-Zurich
United Kingdom	REL Equipment and Components Ltd.	Croft House, Bancroft, Hitchin, Herts SG5 1BU

Beckman Instruments Limited  
Components International  
Queensway, Glenrothes, Fife KY7 5PU, Scotland

**BECKMAN**® 

## Electronics International

by events in transmission," he adds. Although the new circuit costs about 45% more than the old standby MC1310, four set makers have already designed it into their new models.

**Problem-solver.** It is not hard to understand why receiver manufacturers, notoriously tight-fisted on components costs, are willing to pay a premium for the new circuit. Because of the channel separation for frequency-modulation broadcasts in Europe, sidebands of adjacent transmitters can fall in the 114-kHz region, which happens to be the third harmonic of the stereo subcarrier. Until now, the set makers have been relying on a notch filter upstream of the PLL decoder to handle the problem.

However, a single notch filter won't do now for a stereo receiver destined for the kingpin West German market. The Germans have introduced a road-traffic-information system that puts an amplitude-modulated 57-kHz subcarrier onto the signal. That arrangement demands a second notch filter, and the two that are needed make the higher-cost IC a viable competitor, particularly since Motorola has also included circuits that provide monaural-stereo blend and amplifier stages in the 4500A.

**Operation.** Essentially, the layout is the same as for the earlier IC decoders. The composite input signal from the receiver's discriminator is fed to a preamplifier. It supplies two outputs: one for the PLL and stereo-switch sections, and another for the decoder section.

To render the decoder and PLL circuits insensitive to interference by 114-kHz and 57-kHz inputs, Motorola uses modulating functions—based on digitally generated square waves—from which the third harmonic has been removed, as well as the second. This design means that the modulating functions must have three-state forms, but they are obtained by applying two-state waveforms to a chopper modulator. The driving signals come from a three-stage register, which is connected as a Johnson counter. □



# Opening new frontiers with electro optics

## PMT with big new "teacup" dynode gives scintillation counters better PHR.

We expect quite a tempest over this teacup. It's a radically different RCA approach to large-diameter PMT's: The teacup is a large, cup-shaped first dynode that is an improvement over conventional venetian-blind types. It has better spatial uniformity and better off-axis uniformity. As a result, PHR (Pulse Height Resolution) is improved by 0.3% for Cs<sup>137</sup> [NaI (Tl)] and 0.7% for Co<sup>57</sup> [NaI (Tl)].

RCA 4900 is the first in a whole new family of 2" to 5" circular and hexagonal face PMT's with teacup first dynodes. It has a 3" diameter, 10 stages, and "blue" cathode responsivity of 10  $\mu$ A/blue lm minimum, 10.5  $\mu$ A/blue lm typical. Available with voltage divider network.

### High performance in exacting applications

Besides scintillation counting, the teacup PMT can also be useful in gamma ray spectroscopy

for medical applications. Several leading manufacturers of medical diagnostic equipment recently conducted their own tests on these gamma-camera type tubes, and pronounced them a giant step forward in improving camera performance.

If electro optics can solve your problem, remember: EO and RCA are practically synonymous. No one offers a broader product spectrum. Or more success in meeting special needs. Call on us for design help or product information. RCA Electro Optics, Lancaster, Pennsylvania 17604. Telephone 717-397-7661. Sunbury-on-Thames, Middlesex TW16 7HW, England; Ste.-Anne-de-Bellevue, Quebec, Canada; Belo Horizonte, Brazil; Hong Kong.

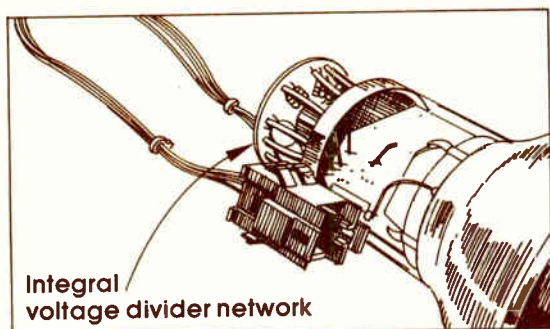
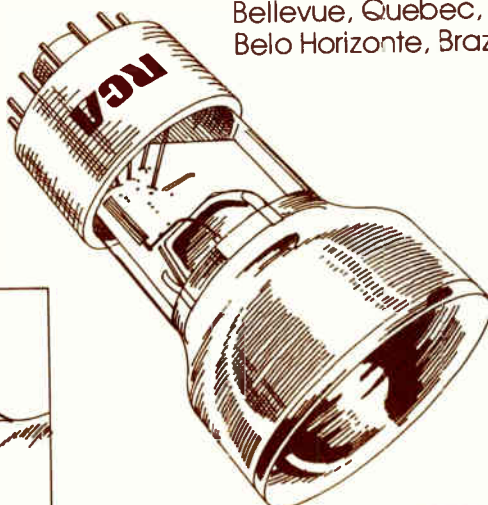
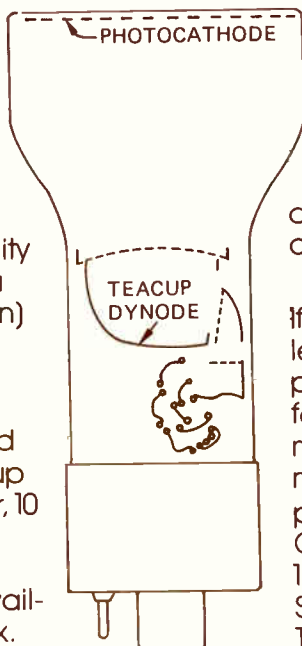

Circle 236

# RCA

# Linearity

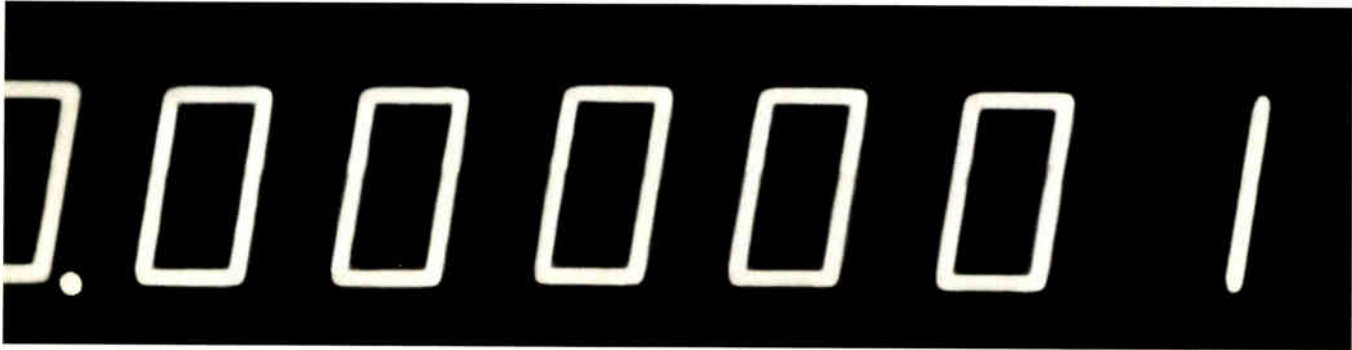

## Would you believe one-part-in-a-million?

Design a DVM of this accuracy, add a true 0.00011% three month stability – without recalibration – and you're liable to create a credibility gap. That's what happened with our SM 215.

For there was no way that conventional design could achieve this unique spec'. Certainly not in a portable lab instrument capable of operating over a wide temperature range.

But we did it with a unique combination of two basically different techniques of digitisation. For the most significant decades we replaced the conventional resistor network with an inductive divider system. Then for the remaining decades we employed integrating dual ramp technology. The result – the best of both worlds. Standards room accuracy, while still retaining the outstanding noise rejection needed for routine measurements.

Now there's MK II – or to give its full title SM 215 MK II Programmable dc Voltage Transfer Standard/Digital Voltmeter – the world's most accurate DVM. We can hear you saying – "with a spec' like this who needs a Mark II?" Simply, to provide programmability for the ATE man. And would you believe that SM 215 MK II costs less than many lesser DVM's? Don't take our word for it. Let us demonstrate just how far ahead of conventional thinking it really is.



**EMI SE Labs**

SE LABS (EMI) LIMITED,  
Spur Road, Feltham, Middlesex TW14 0TD, England.  
Telephone: 01-890 1477. Telex: 23995.

A member of the EMI Group of companies. International leaders in music, electronics and leisure.

# Generator covers eight decades; output is clean

by John Gosch, Frankfurt bureau manager

R&S test oscillator spans 10 kilohertz to 1 gigahertz for precision measurements in shop and laboratory

A signal generator that West Germany's Rohde & Schwarz is readying spans from 10 kilohertz to 1 gigahertz, and the spectral purity of its output is high over the entire frequency range. "With communications equipment and associated components using ever higher frequencies, the market called for a test-signal generator capable of operating as high as 1 GHz," says Heinrich Löffler, who developed the instrument. "The wide frequency range makes it possible to use just one signal generator for measurements that formerly called for several limited-range instruments."

The eight-decade SMDS follows

the Munich company's SMDW signal generator, which because of its 10-kHz-to-500-megahertz range has become something of a best seller since it was introduced in international markets three years ago. However, that range no longer suffices for many test and measuring tasks in today's communications equipment. The SMDS, which can be operated by itself or as part of an automatic test setup, will be introduced at the Hanover Industrial Fair next month and will be ready for delivery in July or August. The price has not yet been determined.

What should prove particularly advantageous in measurements on, say, radio-telephone equipment, is the high spectral purity of the output. The spurious-response ratio is 86 dB up to 500 MHz and 80 dB on up to 1 GHz. The signal-to-noise ratio, referred to a measuring bandwidth of 1 hertz, is typically 90 to 130 dB, depending on how far the

measuring band is spaced for the carrier.

The signal generator should prove its worth in a variety of high-precision measuring jobs, both in the laboratory and the test shop. Because of its programmability and the availability of its output signals over the entire range without the need for range switching, the instrument provides an economical way to handle many measuring tasks, Löffler says. It can measure frequencies of filter and quartzes, check out frequency meters, and test selective receivers. Since the frequency electronically switches from one value to another virtually without overshoot in 20 to 400 microseconds, depending on the decade, the instrument is suitable for digitally sweeping highly selective two- and four-terminal networks.

Heart of the signal generator is the master oscillator with its 10-MHz harmonic-mode quartz crystal installed in a thermostat to ensure



## New products international

frequency stability under widely varying ambient temperatures. The long-term frequency drift rate is better than 2 parts in  $10^9$ , while short-term drift rate is better than 1 part in  $10^9$ .

The instrument's output is produced by a combination of frequency synthesis and analysis, and all frequencies are derived from the master oscillator. Alternatively, an external frequency source—for example, an atomic frequency standard—can be used for highly accurate measurements, such as offsets for television-transmitter equipment and the like.

The instrument's eight decade switches can set the output frequency in 10-Hz increments up to 500 MHz and in 20-hertz increments on up to 1 GHz. The accuracy is controlled by the master oscillator or an externally connected frequency standard. By turning a crank-type knob, the user can quasi-continuously vary the output frequency in either direction and yet retain full crystal accuracy over the entire frequency range. Eight Nixie tubes display the frequency values.

Control knobs and switches on the front panel are arranged in frequency-control and voltage-control functional groups to facilitate instrument operation. Turning the mode switch to the furthest left position activates the eight decade switches. The next four positions are for adjusting the increments of the quasi-continuous frequency. When the switch is in the remote-control position, frequency commands can be fed to the signal generator in BCD code. IEC-bus control is also possible by means of a code converter and a calculator.

The output voltage is 1 volt into 50 ohms. Automatic leveling ensures that the frequency-response characteristic is less than 1 dB. When the instrument is used with the firm's programmable attenuator DPVP in remote-control applications, levels can be set in 0.1-dB increments. Any standard modulation method can be used on the input to modulate the output.

Rohde & Schwarz, 8 Munich, P.O. Box 801469, West Germany.



Three lock-in amplifiers offer operation in square-wave, fundamental-only, and "any-waveform" true-correlation modes. Top of the line is the 9503SC, which includes push-button switching among its three modes. Brookdeal Electronics, Bracknell, Berks. RG12 4PG, England [443]

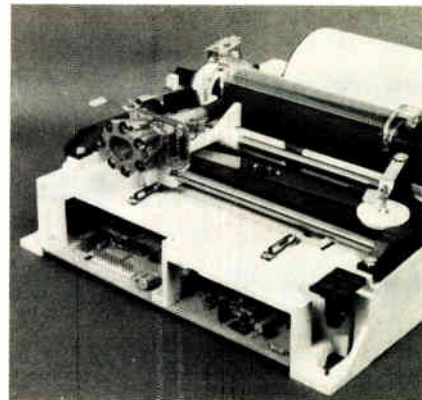

Powered by a single supply of 12 V dc, the 115DR printer operates at 66 characters a second. It can print any character that can be formed with a matrix of 5 by 7 columns. The printer uses standard paper up to 115 mm wide. Philips, P.O. Box 523, Eindhoven, The Netherlands [446]



Dual power-unit packages, the Weir Twin-pack, are based on the company's Mini 400 series. Each dual package consists of two bench-variable supplies in a single housing and a single ac-mains supply input. Weir Instrumentation Ltd., Bognor Regis, Sussex, England [444]

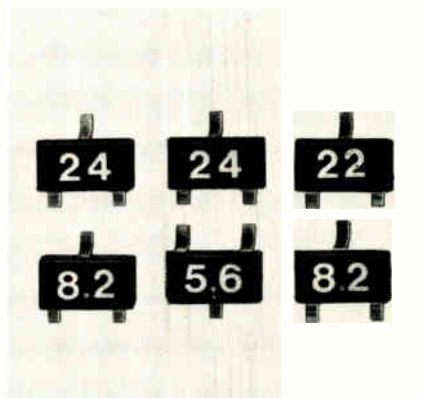

Made for hybrid circuits, miniature Z-diodes housed in a 23A3 package are rated at 100 mW and from 3.3 to 39 V, with a tolerance of 5%. They come in a special magazine designed for automatic handling equipment. Ditratherm, 8300 Landshut, West Germany [447]



A multichannel variable filter, the VBF-19, can be controlled manually, remotely by a computer, or in a dc tracking mode from an external analog signal. Each of the filter's 14 channels has a tunable pc filter card. Kemo Ltd., Elmers End, Beckenham, Kent, England [445]



With a screen measuring 8 by 10 cm, the model HM512 oscilloscope ranges in frequency up to 40 MHz at -3 dB and to 50 MHz at -6 dB. The time base is variable in 21 steps from 1.5 seconds per centimeter to 0.1  $\mu$ s/cm. Neumueller GmbH, 8 Munich 2, Karlstr. 57, West Germany [448]



Built for laboratory and service work, a group of tools called Lab Set includes variable-temperature soldering irons, a desoldering unit, a hot-air blower, and thermally operating insulation remover. Knuer KG, 8 Munich 80, Ampfingstr. 27, West Germany [449]

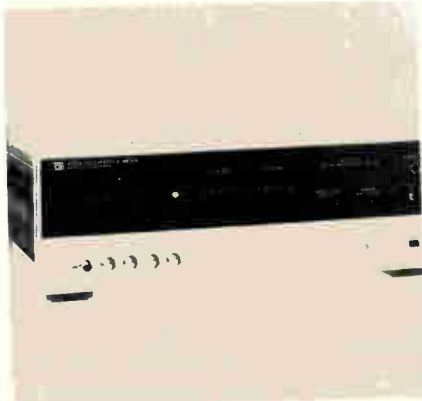

Making eight measurements a second, the model 4273A preset C-meter is designed for on-line inspection in the manufacture of capacitors, as well as for incoming and outgoing inspection. Accuracy is basically within 0.1% of reading. Yokogawa-Hewlett-Packard, Shibuya-ku, Tokyo 151, Japan

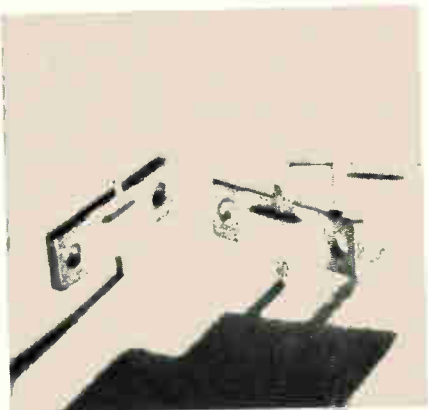

Field-effect transistors in the FLC series deliver linear power up to 8 GHz for full coverage of C band. The n-channel GaAs Schottky FETs are suitable for Class A microwave linear power and for oscillator applications. Fujitsu Ltd., 6-1-1 Shimbashi, Minato-ku, Tokyo 105, Japan [451]

Please, note on your diary ...

31st



march

1st



april

2nd



april

4th



april

5th



april

6th

*PARIS  
closed on  
sunday 3*



april

salon international des  
**composants  
électroniques 77**

4 sections : Components - Measurement  
Raw Materials & Products - Equipment & Methods

an ever increasing number of visitors :

1974 - 57.000

1975 - 61.000

1976 - 72.000

permanent entrance cards

**You must come to Paris again this year !**

Further particulars  
and free entrance  
cards on request:

S.D.S.A.  
20, rue Hamelin - F 75116 Paris  
☎ (1) 505.13.17 + ☎ 630.400 F

## New products international

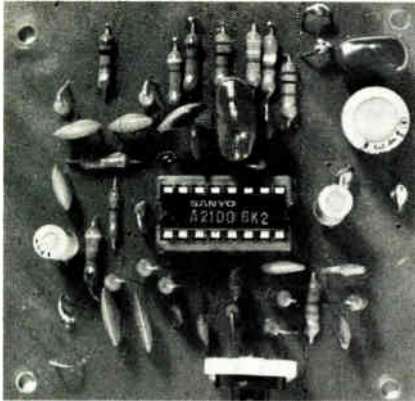

Designed specifically to cancel impulse noise generated by automobile engines, the LA2100 integrated circuit is specially useful for fm stereo receivers. It erases the high frequencies generated by ignition noise. Tokyo Sanyo Electric Co., Ora-gun, Gumma 370-05, Japan [452]

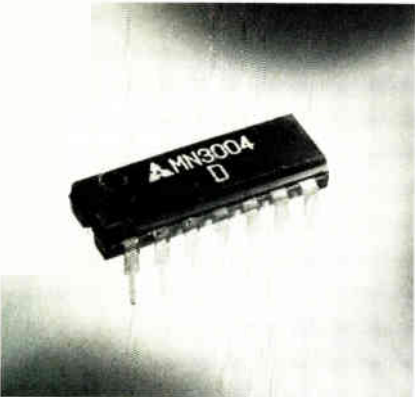

A 512-stage bucket-brigade device for audio-signal delays uses p-channel silicon-gate technology. The MN3004's applications include variable speech control of playback and voice control of tape recorders. Matsushita Electronics Corp., Nagaokakyo, Kyoto 617, Japan [453]

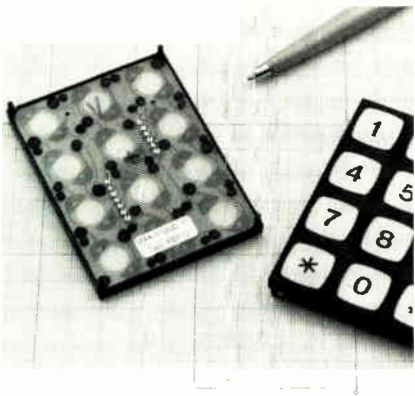

A low-profile 12-key keyboard, the KDP 12, is only 5.3 mm thick. When depressed, the keys travel less than 1 mm. The keyboard, sealed against dust and other industrial contaminants, has contact bounce of less than 100  $\mu$ s. ITT Instruments and Components, 92220 Bagneux, France [454]

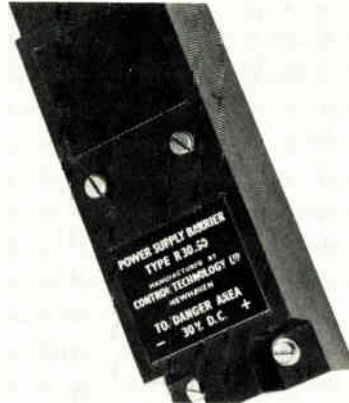

Power-supply barriers are designed for use in the presence of explosive materials. Three models are available: the R50:50 (shown), with an output of 58 mA at 31 V dc; the R42:20, 32 mA at 43 V dc, and the R26:35, 45 mA at 27 V dc. Control Technology Ltd., Peacehaven, Sussex, England [455]

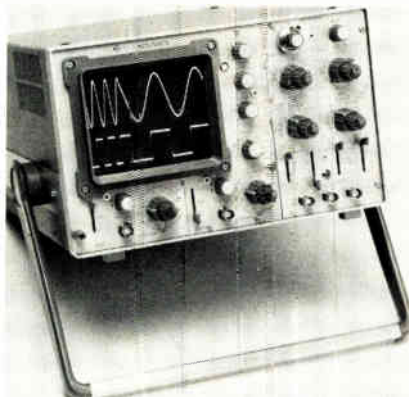

The model OS3000A, a portable dual-trace 40-MHz oscilloscope, offers time-base speeds up to 20 ns/cm. Sensitivity can be adjusted from 5 mV/cm to 20 V/cm, with a 5 $\times$  capability giving 1 mV/cm between dc and 10 MHz. Gould Advance Ltd., Hainault, Essex 16G 3UE, England [456]



A line of electronic delay and interval timers, series 1700, is designed for applications in production machinery. The family includes a panel-mounted unit, the 1703, which fits a DIN-standard 45-mm-square cutout. Controls and Automation Ltd., Hitchin SG5 1LL, Herts., England [457]

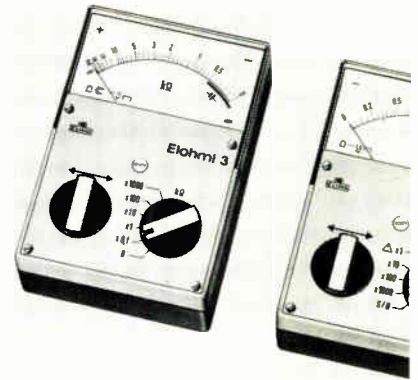

Pocket ohmmeters designated Elohmi 3 and 4 are high-resistance (to 100 M $\Omega$ ) and low-resistance (to 50 k $\Omega$ ) models, respectively. The Elohmi 3 has an IC-based amplifier with low power consumption. Hartmann & Braun, 6 Frankfurt, P.O. Box 900507, West Germany [458]

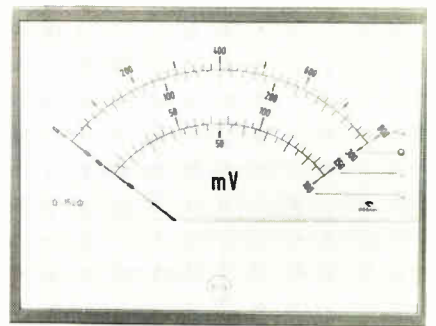

To avoid error, LEDs identify the measuring range being used on an instrument scale. As shown, up to four LEDs are vertically arranged along the right edge. They are spaced 6.5 mm apart. Gossen GmbH, 8520 Erlangen, P.O. Box 1780, West Germany [459]

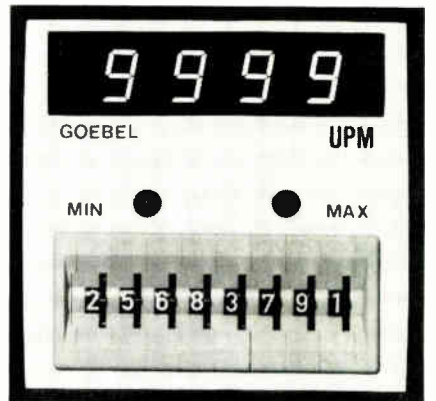

Revolution counters use LEDs to indicate maximum and minimum. The counters are available in three versions: up to 99.99 rpm, 999.9 rpm, and 9,999 rpm. They have an analog output for peripheral instruments. Sinus Electronic GmbH, 7100 Heilbronn, P.O. Box 3067, West Germany [460]

# Industry asked us for hundreds of variations of these switches. Evidently we're pushing the right buttons.

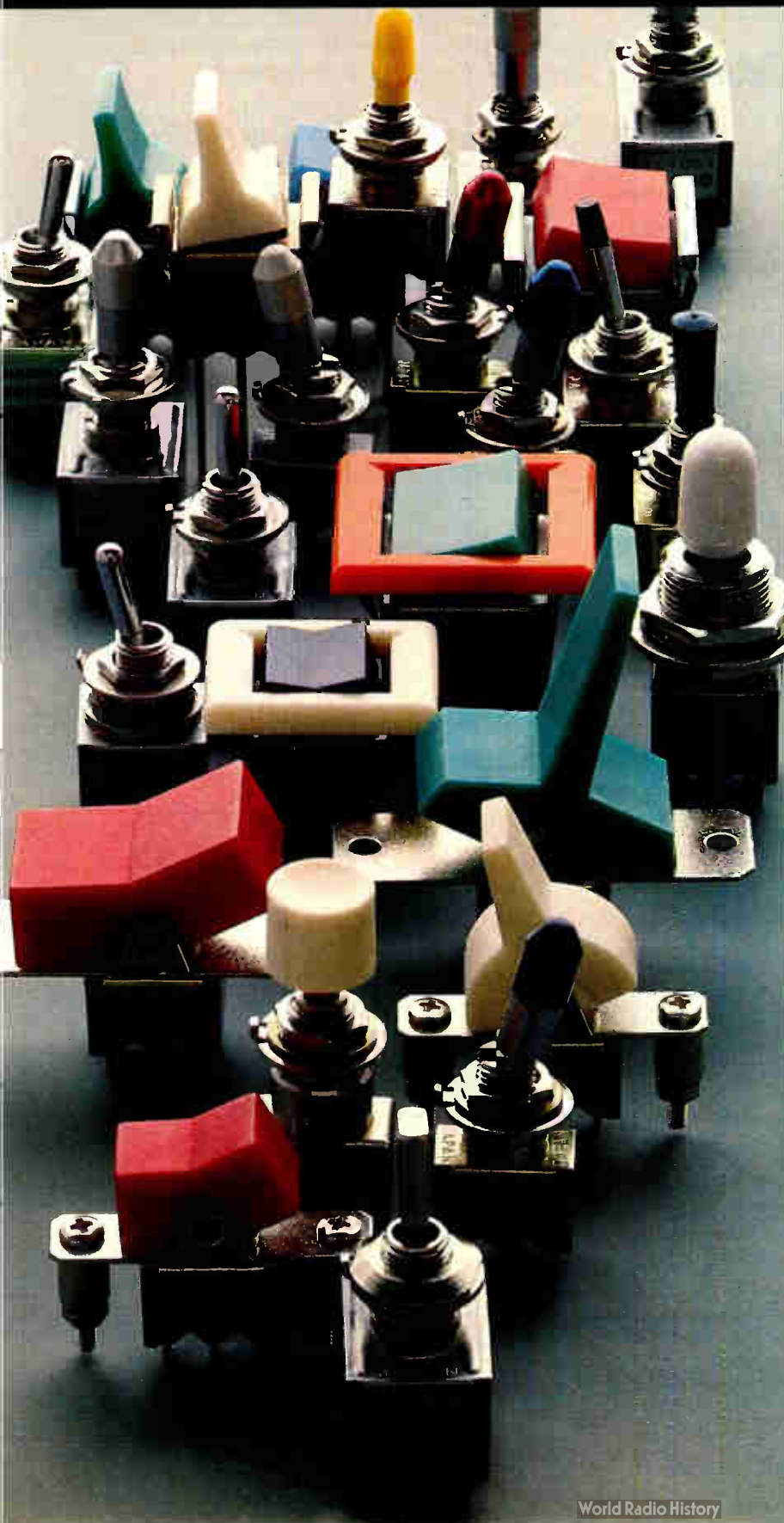

And we intend to keep pushing them.

So that every time one of your new ideas creates a design problem, MICRO SWITCH will be ready with the miniature manual switch that solves it.

At last count, we offered hundreds.

The Series 8 lineup of miniature manuals includes toggles, pushbuttons, paddles and lighted or unlighted rockers. They're UL listed at 6 amps, 125 VAC. And every one is available in a low energy version as well.

Choose terminal variations ranging from solder to quick-connect to PC board or wire wrap. There's also a choice of panel and bushing-sealed pushbuttons and toggles. And non-threaded bushings on PC mounted toggles. Even colored sleeves and integral colored tips for the toggles.

And of course, you'll find one feature you won't find anywhere else—the quality you've come to expect from MICRO SWITCH. Series 8 switches are inspected to a 1% Acceptable Quality Level (AQL).

That's quality you can put your finger on.

For your immediate product needs, see your nearest MICRO SWITCH Authorized Distributor. If you have other requirements, contact a MICRO SWITCH Branch Office or call 815/235-6600.

## **MICRO SWITCH**

FREEPORT, ILLINOIS 61032  
A DIVISION OF HONEYWELL

MICRO SWITCH products are available worldwide through Honeywell International.

Circle 195 for Data.

Circle No. 57 for Salesman call.

# Introducing three new mini's that think like mainframes.

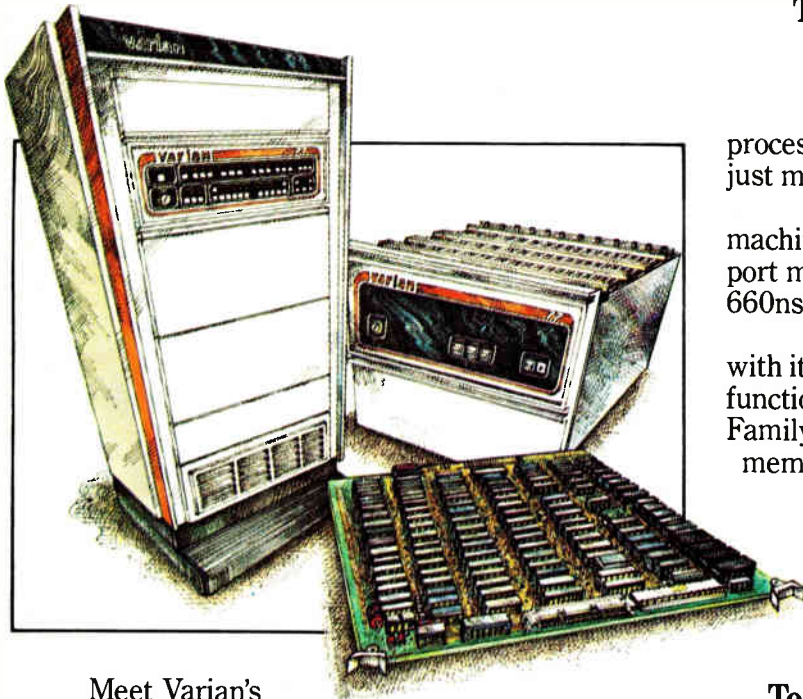

Meet Varian's new V77 Family of high-performance minicomputers.

Three distinctive new models. All fast. Each powerful. A family trio most mainframes can relate to. For help with almost any scientific, industrial, or data communications application.

The V77 Family delivers all the speed and performance you expect from Varian. Plus the unexpected, too. In the form of total family compatibility and shared memory capabilities. Up *and* down the family tree. For complete open-ended flexibility. In capacity and price.

## **The world's first mainframe-on-a-board. Our new V77-200.**

Quite frankly, the new V77-200 delivers more computing power than any other computer-on-a-board you can buy. Handling up to 32K/16-bit words of 660ns MOS memory.

Big machine features include a fully micro-programmed architecture, an 8-register CPU, a 32-bit arithmetic capability, powerful set of 187

instructions, hardware multiply/divide, direct memory access, programmed I/O, real-time clock, and a teletype/CRT controller.

There's big machine performance, too. Example: multiplication functions handled in 4.9 microseconds — divide in just 8.

The new V77-200 means more cost-effective computing in many scientific, instrument control, or data communications environments.

## **The in-between that's a go-between. Our new V77-400.**

If yours is a multiprocessing or distributed processing network application, our new V77-400 just might be "the tie that binds."

Because on top of all its standard big machine features, there's an incredibly flexible dual port memory. (With up to 256K/16-bit words of 660ns MOS memory in a single, standard chassis.)

The V77-400's dual port memory, working with its unique direct memory access system, functions as a bridge when linked to other V77 Family computers in closely coupled, shared memory multiprocessor arrangements.

An optional Writable Control Store is also available. Letting you expand the V77-400's instruction set to further improve the speed of both programming and program execution.

## **Top-of-the-line performance for almost any application. Our new V77-600.**

Varian's new V77-600 sets new standards for all would-be high-performance mini's.

First, with a long list of standard big machine features. Second, with up to 1024K/16-bit words of 660ns MOS memory. And third, with a host of performance enhancing options. Including Writable Control Store, a floating point processor, and special scientific and commercial firmware.

For the ultimate in performance enhancement, an optional high-speed cache memory is also offered — cutting the V77-600's average execution time in half.

## **How our mini's speak fluent mainframe.**

You won't waste any time or money training our new V77 Family how to communicate with your mainframe. Or developing your own control programs.

Because all V77 Family members utilize Varian's VORTEX (or VORTEX II) operating



system — two of the world's best real-time systems.

Both systems permit concurrent job execution by allocating priorities. And help tailor other subsystems to fit scientific to commercial, real-time to batch, and stand-alone to data communications environments.

TOTAL, a highly efficient, network-type data base management system, is now available as a VORTEX II subsystem.

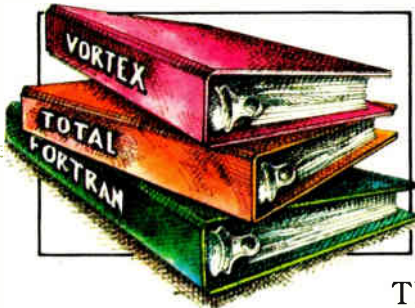

Usually found on only larger computers, TOTAL allows you to define and access your data base with powerful, high-level language processors like COBOL, FOR-

TRAN IV Level G, and RPG-II. Opening the door to large libraries of already developed applications programs.

### The benefits of a well-structured family.

Our new V77 Family represents more than just a continuing commitment to total hardware and software compatibility. Because it's a commitment to solving basic price/performance needs on several different levels.

For those needing more computing power, there's a V77 that's an affordable, high-performance solution.

For those wanting less wasted overhead, there's a less expensive, high-performance alternative.

Plus an attractive new V77 discount plan designed to give even modest-volume OEM buyers a big break.

Finally, for those with special multiprocessing or distributed data processing requirements, there's an entire V77 Family. Specifically engineered to work well

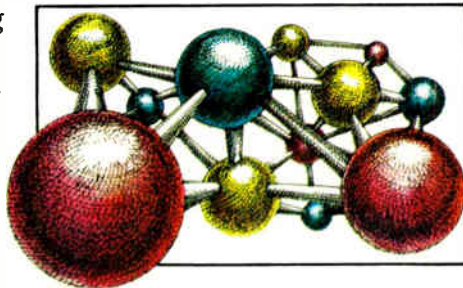

together — through shared memories, intercomputer I/O bus lines, and shared communications channels — as new cost-effective replacements for typical "patchwork" systems.

### Varian. A commitment to innovation.

Varian Data Machines has played a significant role in the evolution of digital minicomputers for almost a decade now.

Consistently producing innovations not only meaningful to the industry, but to the end-user as well. A look at just the last five years tells the story...

In 1972, VDM developed the first mini-computer operating system with all the multi-task and file handling capabilities of a large computer.

A year later, VDM created the first microprogrammed mini-computer with a 64-bit Writable Control Store.

In 1975, two VDM firsts: a minicomputer with a data base management system equivalent to those for large computers, and, the first 64K word semiconductor memory package on a single board.

Today, it's the whole new V77 Family.

Well-structured and ready. Breaking new ground in terms of Varian size, compatibility, and price/performance. Three new mini's that really do think like mainframes.

For additional V77 Family planning literature, contact any of the 38 Varian offices listed below, or Varian Data Machines, 2722 Michelson Drive, P.O. Box C-19504, Irvine, California 92713, (714) 833-2400. In Europe, contact Varian

Associates Ltd., Molesey Road, Walton-on-Thames, Surrey, England, Telephone 28971.

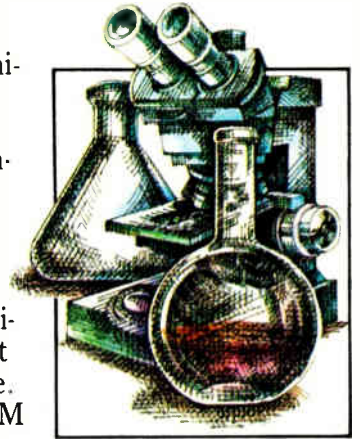

Mini's that think like mainframes.

U.S. OFFICES: Los Angeles (213) 598-4438, San Diego (714) 276-9462, San Francisco (408) 736-5630, San Fernando Valley (213) 990-6042, Seattle (206) 641-4500, Denver (303) 770-2151, Dallas (214) 231-5145, Houston (713) 781-0105, St. Louis (314) 739-6433, Chicago (312) 692-7184, Detroit (313) 645-9950, Cleveland (216) 238-6960, Dayton (513) 258-1458, Orlando (305) 299-1592, Atlanta (404) 252-0047, Washington, D.C. (301) 773-6770, Philadelphia (215) 643-2355, Englewood Cliffs (201) 569-2323, New York City (212) 826-1010, Rochester (716) 586-3273, Boston (617) 890-6072. INTERNATIONAL OFFICES: Brussels (02) 4662000, Darmstadt (06151) 7031, Munchen (089) 8126093, Bensberg (02204) 61066, Amsterdam (020) 15 94 10, Stockholm (08) 820030, Zug (042) 23 25 75, Surrey 093 22 28971, Toronto (416) 457-4130, Montreal (514) 332-2840, Vancouver (604) 736-5621, Ottawa (613) 224-6521, Calgary (403) 276-4456, Melbourne 560-7133, Sydney 43-0673, Sao Paulo (011) 240-3449, Singapore 379-239, Tokyo 403-7101, New Zealand 697-099, Taipei 5815158-9.

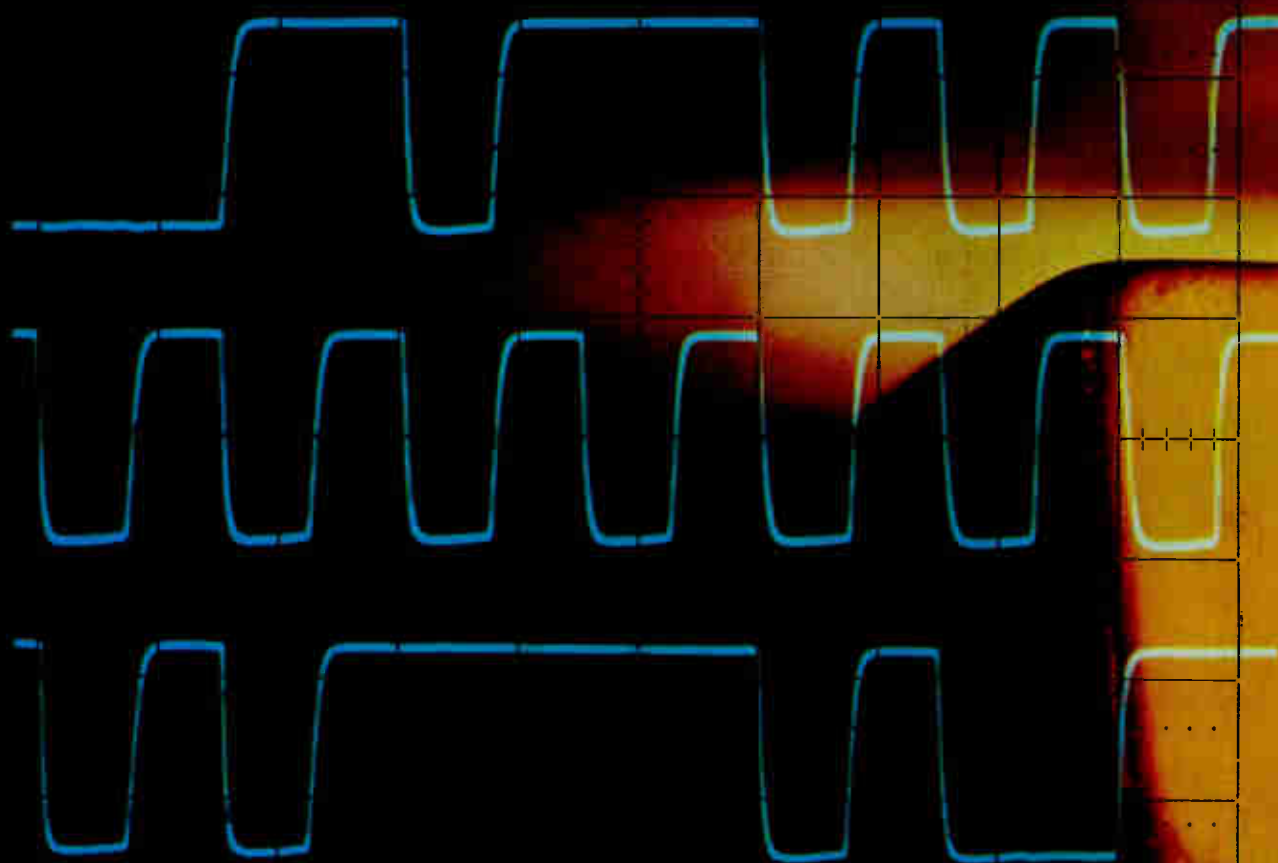

1838	1888	9888	8119
8838	8888	1888	1899
9888	9888	8889	9101
1888	1888	8881	1189
1888	1888	8881	1119
1888	1888	1888	8889
1838	1888	1888	8819
1838	1888	1888	8189

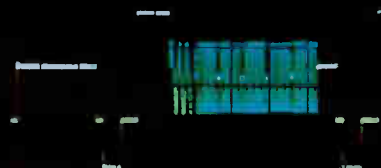

# Want a different view with the touch of a button?

## HP's the Answer.

And the 100 MHz **1740A** is your scope. With HP's push-button **third-channel trigger view**, you can see your trigger signal along with channel A and B—three traces in all—so you can make timing measurements between all three simultaneously. In most applications, that means three-channel capability for the cost of a two-channel scope.

**Here are two more timesaving features you can get at the touch of a button.** For data-domain applications, you can combine the 1740A with HP's 1607A Logic State Analyzer and trigger the scope with the analyzer's pattern-trigger or delayed-trigger output. Add the "**Gold Button**" (an optional logic-state push button in lieu of A versus B) for just \$105\* and (with the 1607A) you have push-button selection of either logic-flow or real-time display. That means you can view the logic states of operational circuitry for pinpointing a problem. Then push the "Gold Button" and see the waveforms you've selected at that specific point in time. Or, add the **TV sync** (optional for just \$180\*) and tailor the 1740A for TV broadcast and TV R&D applications simply by pulling a knob.

The 1740A also has an **X5 vertical magnifier** with the touch of a button for 1 mV/div sensitivity on both channels to 40 MHz without cascading. Again, measurements are simplified because

you can directly monitor low-level signals such as outputs of read/write heads of disc or mag units, power-supply ripple, or medical sensor outputs. You also get selectable input impedance (1 megohm or 50 ohms) plus the time-tested 8 x 10 cm CRT used in the 180 System lab scopes.

At just \$2095\*, HP's 1740A, with its three-trace capability, is an exceptional scope value. Call your local HP field engineer today for all the details.



And here's something **NEW** for scopes. HP's **Easy-IC Probes**. A new idea for probing high-density IC circuits that eliminates shorting hazards, simplifies probe connection to DIPs and generally speeds IC troubleshooting. Ask your HP field engineer about them.

\*Domestic U.S.A. price only.



HEWLETT **hp** PACKARD

Sales and service from 172 offices in 65 countries.

1507 Page Mill Road, Palo Alto, California 94304  
For assistance call: Washington (301) 948-6370, Chicago (312) 677-0400  
Atlanta (404) 434-4000, Los Angeles (213) 877-1282

086/16

Circle 61 on reader service card

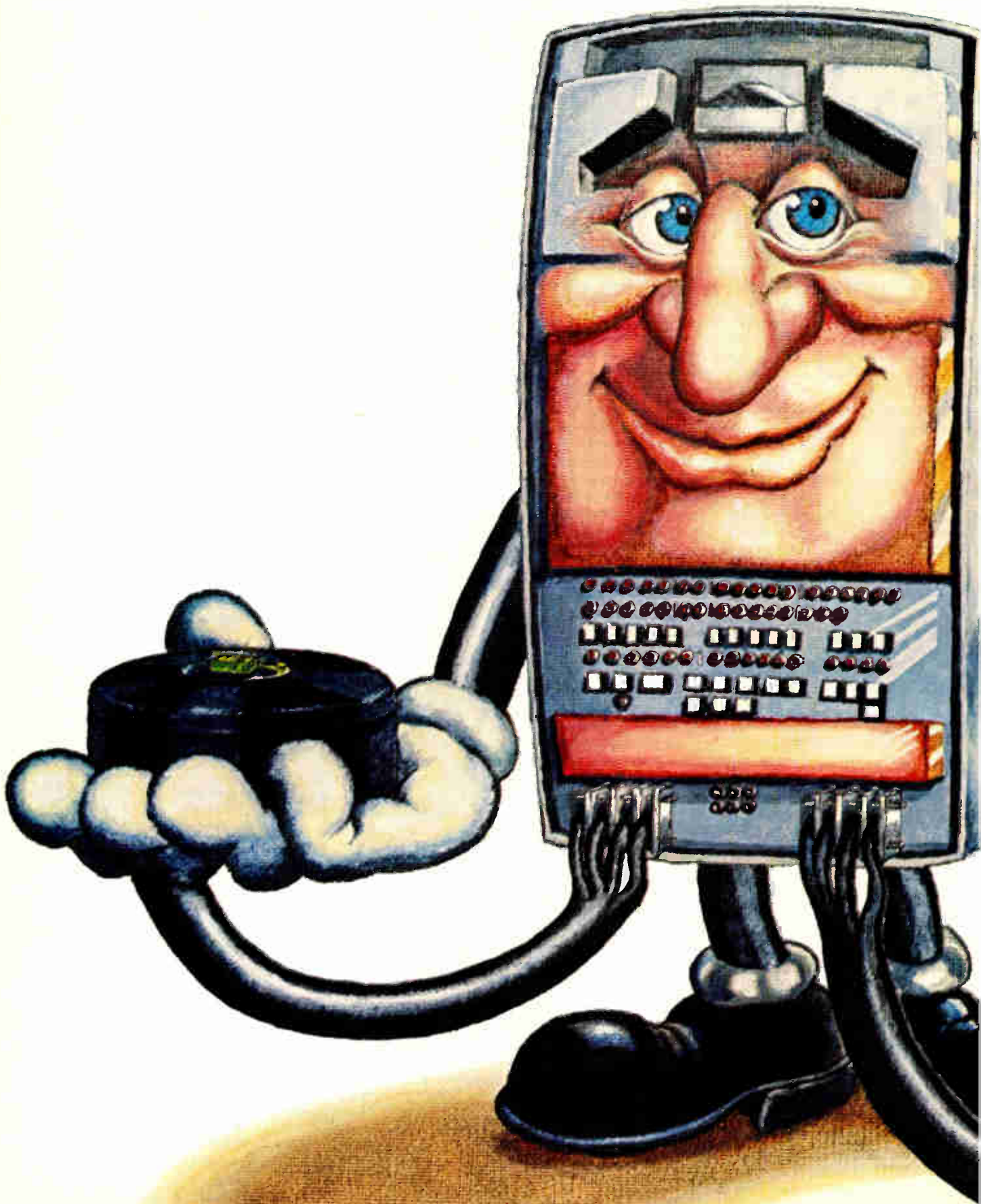

# WHEN IT COMES TO 16K RAM TESTING, YOU'VE GOT TO HAND IT TO XINCOM.

Technology marches on. Just as you're beginning to see the light at the end of the 4K RAM testing tunnel, you notice an even bigger problem coming at you from the other direction. The problem is 16K RAM testing; and it promises to be more complex, expensive, and time consuming than 4K RAM testing by several orders of magnitude. But take heart. Before you've even begun to do some serious worrying about 16K RAM testing, Fairchild is here with the solution.

The solution is Xincom III.

With Fairchild's Xincom III system, you can test up to 500,000 16K RAM's per month per shift, using as many as 8 dedicated and computer controlled testers operating in parallel at a cost of less than \$40,000 per test head.

And while all this rapid, low cost, pass/fail testing is going on in the foreground, the system's host computer can be compiling and storing valuable production, engineering, and business management data in the background.

Things like shmoo plots, histograms, trend graphs, yield analyses, water maps and test throughput summaries.

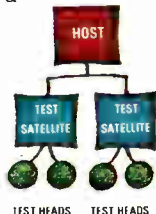

The secret of Xincom III is Fairchild's distributed processing concept. A microcomputer in each tester has sufficient intelligence to allow the tester to stand alone as a pass/fail device; the microcomputer can also perform data manipulation, log test results, and control communications with the host computer. Meanwhile, routine data processing is left to the minicomputer maker's operating system, freeing the bulk of the host computer's intelligence for such important jobs as high level program translation, data reduction to printout, disc storage of results, etc.

Of course, 16K RAM testing is hardly the beginning and end of Xincom III's capabilities. Using the complete set of input software

supplied with the system, it is easily adaptable to anything from TTL/CMOS logic through 64K RAM's and ROM's. And it's no problem at all to test various types of devices, simultaneously, on various test heads within one Xincom III system.

But, for many, 16K RAM testing represents the most pressing memory test problem looming just over the horizon. And we just wanted to assure you that, as always in the field of memory testing, Fairchild has the problem well in hand.

For proof, ask for our free, 22-page, full color brochure containing all the technical data about Xincom III. Better yet, ask for demonstration of the system.

Write or call Fairchild Xincom Systems, a unit of Fairchild Camera and Instrument Corporation, 8944 Mason Avenue, Chatsworth, California 91311. Phone (213) 341-5040. TWX 910-494-2769.



**FAIRCHILD**

Circle 63 on reader service card

# WAFERTRAC. STILL STEAMING AHEAD!

Since GCA introduced the revolutionary WAFERTRAC™ a few months ago—the completely automatic, microprocessor-controlled wafer processing system, 9 out of 10 of the world's largest manufacturers of semiconductors have purchased their WAFERTRAC systems. Why?

WAFERTRAC provides higher yields in less facility space.

WAFERTRAC improves up-time and reliability to higher levels than ever before possible.

WAFERTRAC eliminates traditional 25-wafer group processing limits.

WAFERTRAC lets you design your own specific configuration, according to your firm's unique requirements.

WAFERTRAC.  
The first practical application of the microprocessor to semiconductor processing, requiring only a single person in your processing loop ... and *then* only to load and unload carriers.

Don't be the last to get on board. WAFERTRAC's still steaming ahead... destination: greater profits!

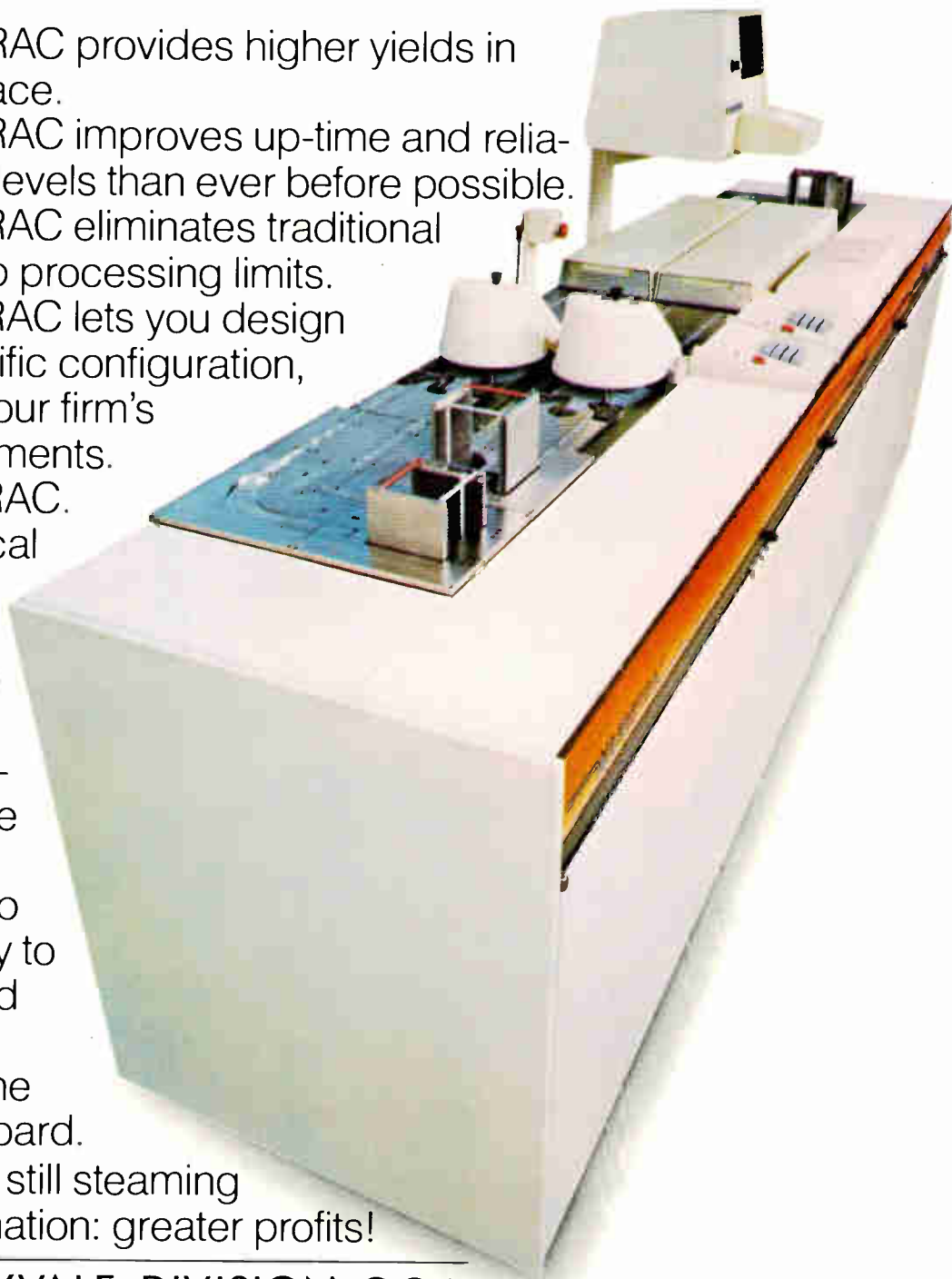

**GCA/SUNNYVALE DIVISION ●●▲**

PART OF THE GCA/IC SYSTEMS GROUP  
1050 Kifer Road, Sunnyvale, Calif. 94068 TWX: 910-339-9211 (408) 732-5330

64 Circle 64 on reader service card

Electronics / March 3, 1977

## Army speeds fiber optics

Optical fibers expected to replace cable in the 1980s; test results exceed specs

by Bruce LeBoss, New York bureau manager

The U.S. Army is confident that by the mid-1980s it will be replacing copper wire with optical fibers in its tactical communications systems. The fiber-optic conductors, which are markedly lighter and smaller, will provide larger bandwidths at potentially lower costs—perhaps down to 10 cents per meter.

"Thus far, fiber optics equals or exceeds our expectations," states Robert Christian, electromagnetic-transmission team leader at the Army Electronics Command's Communications Automatic Data Processing Laboratory at Fort Monmouth, N.J. Like the Air Force and Navy, which are working on fiber-optic replacements for coaxial cable in aircraft and ships, the Army is aiming its fiber-optics developments at that mid-1980 target.

In the words of Gerald Aaronson, division program manager of GTE Sylvania Inc.'s Communications Systems division, "Progress in fiber-optics techniques is so rapid that, within the next few years, they will appear in a number of defense-communications systems now in the design and development stages." They are particularly suited for defense communications because of their immunity to electromagnetic interference, and they are "only 1/50 the size and weight of 1/4-inch-diameter copper coaxial cable."

**Setting the objectives.** Since 1974, when the Army first became seriously interested in fiber-optic communications, its primary aim has been to replace the twin-coaxial cable used for long-haul communications systems and the 26-pair cable used in local-distribution systems. "To date," says Christian, "all of the

fiber-optic developments for these two programs, as well as for supporting programs, have met all of our specs with one exception." That exception is a hammer test, "which may not be a necessary spec at all for the environment that the equipment will be used in."

For long-haul communications, the objective is a ruggedized fiber-optic system that will transmit up to at least 8 kilometers, unattended, without repeaters. "Right now, if we were to go to a 64-km system with present cabling," says Christian, "we would need 19 repeaters every 8 km, or one in less than every half mile. But with a fiber-optic cable, the indications are we could do the same job with only one repeater every 8 km, or seven repeaters in all." Perhaps more important, "this would result in a big savings in cost and a significant improvement in reliability."

**Useful.** Under an \$80,000 contract awarded in 1974, Corning Glass Works of Corning, N.Y., "demonstrated that we could create a useful waveguide cable with a reasonable set of useful properties, such as lighter weight and smaller size, with attributes that made it desirable for long-distance communications," states Al Fairaizl, Corning's senior sales engineer in charge of Government sales. Corning's work yielded a first-generation fiber-optic cable that has an attenuation of less than 20 decibels per km.

Corning, at its own expense, further refined the cable, sold commercially as Corguide. The company is now selling to the military and commercial markets cables that attenuate less than 10 dB/km, are more resilient, less subject to tem-



perature variations, and provide better optical performance than the original Corguide. These cables are part of a Corning proposal to the Army in competition for a one-year, \$100,000 contract for exploratory development of a long-haul fiber-optic communications system.

In the second half of this year the Electronics Command expects to

## Probing the news

seek proposals to conduct exploratory development of a fiber-optic cable for such systems as the AN/TTC-38 tactical switch. The present cable, says Christian, requires shielding, which adds massive weight and size, to eliminate crosstalk. With fiber optics, "we expect to achieve a 10:1 volume reduction and a 14:1 reduction in weight."

Other work is also going on. In 1975, International Telephone & Telegraph Corp.'s Electro-Optical Products division in Roanoke, Va., received about \$90,000 for early prototypes of a fiber-optic cable to replace the 26-pair cables used in command-post-type applications. Unlike Corning, which developed a glass-on-glass cable, the ITT division developed a plastic-clad glass cable that, says product-line manager Robert Williams, "was a very rugged, low-cost cable." The ITT contract, which is about to be extended, calls for increasing the flexibility and handling properties, as well as the impact resistance.

**Tri-Tac input.** Meanwhile, GTE Sylvania's Communications Systems division in Needham, Mass., has just completed work on a \$63,000 contract from the Electronics Command to identify segments of the triservice tactical communications network, Tri-Tac, that can use fiber-optic systems. "The first application may

be as transmission links in the AN/TTC-39 switch GTE is developing for the Department of Defense's Joint Tactical Communications Office network," says program manager Aaronson.

GTE was to examine how best to use fiber-optic cable to replace coaxial copper cabling for signaling, but not power functions. The problems of powering fiber-optic communication systems and determining the data format, among others are being explored under an \$80,000 contract awarded to ITT last September. That eight-month contract calls for the Roanoke division to develop a fiber-optic system for use in a simple pulse-code-modulation communications network.

**Backup.** The Army also has several backup programs to develop methods of manufacturing light sources and photodetectors, as well as developing ultra-low-loss cables, connectors, and rapid payout systems from which it can distribute cables from vehicles, including the helicopter. One of the largest of these programs is being conducted by Valtec Corp.'s Laser Diode Laboratories subsidiary. It has two contracts totaling almost \$500,000 to build reproducible high-brightness light-emitting diodes and injection diode lasers.

The Laser Diode work, contracted for by the Electronics Command's Combat Surveillance and Target Acquisition Laboratory, follows

some preliminary work by the RCA Laboratories in Princeton, N.J., which developed a triple-stripe laser that operates in the 820-nanometer range and emits three beams in parallel on a laser substrate.

RCA built a system that emits 250-milliwatt 10-nanosecond pulses and has a repetition rate of 10 MHz. "We achieved 6,000-plus hours of life tests by the time the contract expired" in mid-1976, notes Henry Kressel, RCA semiconductor devices group head. The Army is looking for 10,000 hours of life testing, and "we're confident we could have done it," he adds. Major contracts for sources and detectors in the 1.06-micrometer range will be out later this year.

Of course, as is so often the case with emerging technologies, an unsolved problem lies with the connectors, says the Army's Christian. "We don't yet see a military connector for a fiber-optic system, but we don't doubt that we'll have them eventually," he says. The Army is looking for connectors that can accurately and repeatedly align multiple fibers in a small core in the field.

ITT's Cannon Electric division in Santa Ana, Calif., is trying to build a six-fiber optical connector with less than 1-dB repeatable insertion loss. "But there's a five-month extension to the contract at no cost to the Government," says Christian. "The first units didn't work, but we're confident that industry will be there with the connectors that we want when the need and market arises."

Perhaps one of the more significant promises of fiber-optics is potentially lower life-cycle costs, including less expensive repeaters and fewer repairs and spares, as well as lower costs for transporting and storing the smaller and lighter fiber-optic cables.

As for cable costs, "we firmly believe we can get the cost of fibers down to the order of 10 cents per meter for annual quantities of 50,000 to 100,000 kilometers," says Corning's Fairaizl. Adds the Army's Christian, "We had originally anticipated a cost of 40 cents a meter." Cable costs are expected to be about 50 to 60 cents per meter for a 0.25-in.-diameter cable with six fibers and some strength members. □

**Strictly comparable.** These two reels of 26-pair coaxial cable are length for length the equivalent of the single reel of fiber—vivid proof of the latter's small diameter.

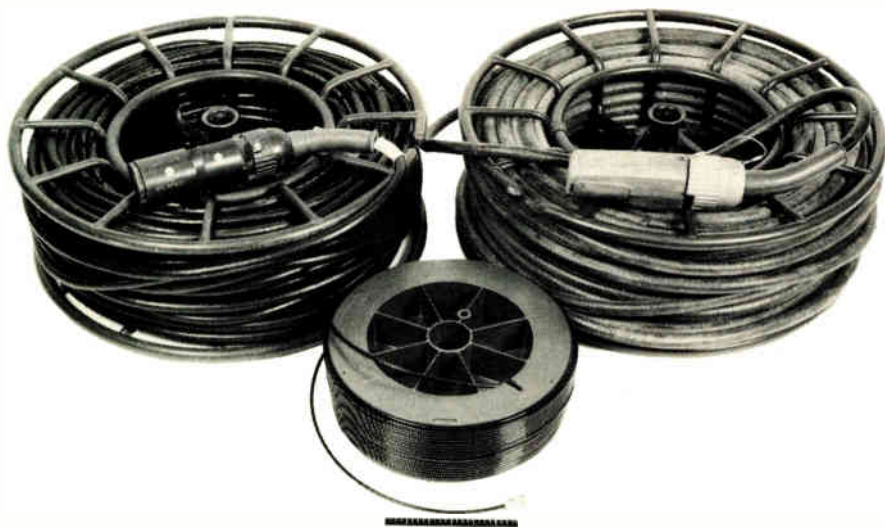



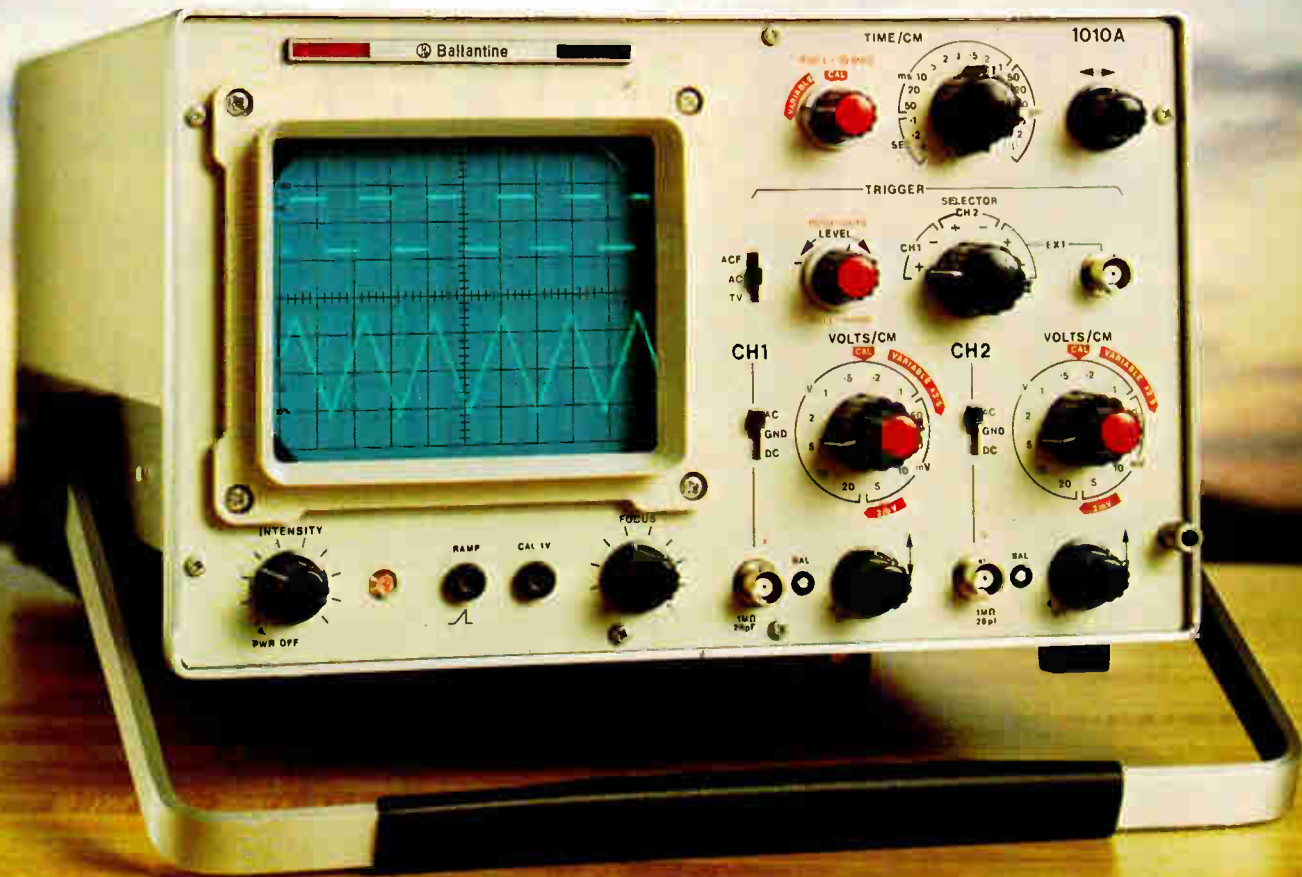

# A SCOPE FOR ALL REASONS

Finally a professional oscilloscope to fit your basic needs.  
 High quality, easy to maintain, and easy to use.  
 Ideal for production, design laboratories, field service and schools.

## Ballantine Model 1010A Dual Channel and X-Y oscilloscope

- FREQUENCY:** DC to 10 MHz each channel  
 35 nanosecond rise time. 15 MHz full scan.
- SENSITIVITY:** 2 mV/cm to 20 Volts/cm  
 Continuously variable gain.
- TIME BASE:** 100 ns/cm to 1.25 s/cm  
 X10 Magnifier, Trigger beyond 20 MHz
- PORTABILITY:** Only 7 Kg. (15 pounds)
- DISPLAY:** 8 x 10 cm CRT with 3600 volts
- ECONOMY:** \$ 595

Available on GSA Contract GS-00S-04619, Stock Number 6625-00-472-9910.

# Ballantine

Ballantine Laboratories, Inc., Boonton, New Jersey 07005 USA

Circle 67 on reader service card 67

# We'll flip you over your ceramic capacitor specs... **heads you win** **tails you win**

Heads are our standard line of MONO-KAPS™. Radial-leaded, epoxy-coated monolithic ceramic capacitors with noble-metal electrodes whose proven formulation has not been modified or compromised. They meet MIL requirements, and are available off-the-shelf in a broad range of capacitances and voltage ratings to meet your specific needs.

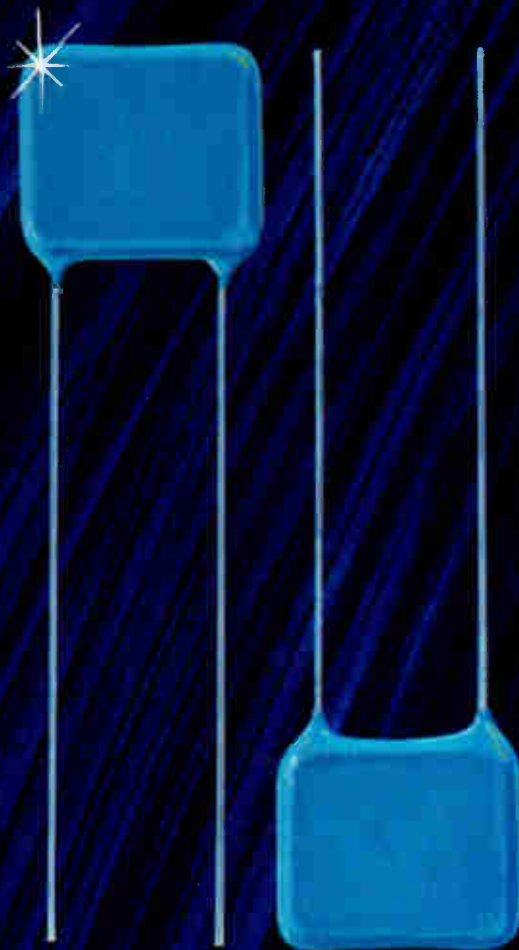

Tails are our BME-Radials™. They protect you from the noble metal cost spiral, and save you money right up front. They are the product of our unique BME capacitor technology which eliminates noble metal entirely from electrodes and terminations. But they'll meet most of the same circuit requirements with no sacrifice.

So you see, it's up to you — MONO-KAPS or BME-Radials. Both are immediately available in quantity from the only people who give you the choice. Either will do the job without compromise. Call or write for all the details today.



**CENTRALAB/USCC** 4561 Colorado Blvd. • Los Angeles, CA 90039 • (213) 240-4880

Electronics • GLOBE-UNION INC.

"See our complete catalog in EEM pages 317 to 335, and gold book pages 103 to 121, or contact us directly."

World Radio History

Communications

# Aiming satellite TV at rooftops

Delegates to ITU conference agree on orbits and allocate frequencies in Eastern Hemisphere for direct broadcasting after mid-1980s

by Arthur Erikson, Managing Editor, *International*

**Telecommunications officials** from around the world are already planning how to beam television broadcasts through communications satellites in geostationary orbit to individual rooftop antennas. While it will be the mid-1980s or later before significant numbers of viewers will be receiving programs that way, the prospect of broadcast-satellite service—or BSS as it's known—already has national radio-TV organizations excited, particularly in highly developed countries where terrestrial networks are out of the question.

The tab for full-fledged BSS will run in the hundreds of millions of dollars for most countries, and none yet has a clear idea of how or where to raise the money. Nonetheless, systems planners around the world can go to their drawing boards right now if they want to. The technical parameters for BSS were blocked out by experts from 111 countries during a five-week International Telecommunications Union World Administrative Radio Conference in Geneva that ended in mid-February.

Moreover, channel allocations in the 12-gigahertz band, and satellite positions as well, were worked out for countries in Europe and Africa (ITU Region 1) as well as Asia and Australasia (Region 2). North and South American countries, urged by the United States to postpone detailed planning, assigned no channels but did set aside positions in space for BSS. Channel assignments will come out of a conference by 1982 at the latest. In all three regions, the frequency band of 11.7 to 12.2 GHz (12.5 GHz in Region 1) can be used also for satellite and terrestrial services, further compli-

cating the problem of allocations.

**Delay.** U.S. delegates wanted a delay because, as one put it, "we don't want to get locked into 1970 technology." And, although the 25-man U.S. delegation was not fully persuasive, it did convince the representatives of other American countries to set slightly more stringent

**Carrying the flag.** Heading the United States team at last month's Geneva conference on broadcast-satellite service was FCC Commissioner Robert E. Lee.



system parameters—implying better technology—than did the Africans, Europeans, Asians, and Australasians. "We can live with this flexible plan; it's not too bad," says FCC Commissioner Robert E. Lee, who headed the U.S. delegation.

By and large, the delegates from the other 110 countries went home satisfied. "This is the first administrative conference I know of where we didn't have to take votes [in plenary session] to settle issues we couldn't get a consensus on," says one ITU official.

For BSS, the conference agreed that the basic broadcast signal would be frequency modulated, although other types of modulation were not ruled out so long as they do not interfere more than straight fm; beam polarization will be circular. In Regions 1 and 3, the power-flux density was set at  $-103$  decibel-watt at the edge of the coverage area (about the same as the half-power contour around the axis of the beams' intersection with the earth). At the  $-103$ -dbw level, a receiver with a figure of merit (G/T) of 6 dB/kilometer and an antenna 0.9 meter in diameter will do for individual reception. At the satellite, this level works out to an effective isotropic radiated power (EIRP) of 67 dbw. For systems designed for community antennas, flux density was set at  $-111$  dbw.

**Lower power.** The American countries plan to transmit slightly less power, providing a power-flux density of  $-105$  dbw at the edge of the coverage area for individual reception. This translates into 63 dbw EIRP at the satellite, and a 1-meter will be needed for the

# tiny but tough ...Grayhill push-button switches



## from logic levels to UL-listed power switching

- As small as .250" diameter, .675" over-all length
- Wiping or butt contacts; momentary or alternate action; SPST, SPDT, DPDT
- Bezel, bushing, or sub-panel mounting, variety of button colors and shapes

Available locally  
through these representatives

**Copenhagen, DENMARK**  
E. V. JOHANSEN ELEKTRONIK A-S

**London, ENGLAND**  
HIGHLAND ELECTRONICS LTD.

**Neully-Sur-Seine, FRANCE**  
RADIO TELEVISION FRANCAISE

**Munich 21, GERMANY**  
DATA MODUL GmbH

**Tel-Aviv, ISRAEL**  
RAPAC ELECTRONICS LTD

**Rome and Milan, ITALY**  
MICROEL-ITALIA SRL

**Stockholm, SWEDEN**  
BO PALMBLAD AB

**Zurich, SWITZERLAND**  
WALTER BLUM LTD.

or send for free literature

## Probing the news

receiver. This density is higher than the 58 dbw of the U.S./Canadian communications-technology satellite, which uses a record-high-power 200-w traveling-wave-tube amplifier for direct broadcasts.

The American countries also will work with smaller bandwidths than the Region 1 and 3 countries. In their frequency plan, the necessary bandwidth was set at 27 MHz with guard bands of 14 MHz at the lower edge of the band and 11 MHz at the upper edge. Region 2 bandwidths are 8 and 23 MHz, with guard bands of 12 and 9 MHz.

As for the satellites, the plan laid down for regions 1 and 3 presupposes a nominal spacing of 6° between BSS satellites around the equatorial orbit. Lower-powered satellites for telecommunications services can be slipped between them with adequate precautions against interference. After the BSS satellites have been lofted to their assigned stations, they must not be allowed to drift more than  $\pm 0.1^\circ$ . The antenna beam, too, is limited to a deviation of  $0.1^\circ$  in any direction. There is a  $\pm 2^\circ$  limit on angular rotation of the beam unless the beam is circular and circularly polarized.

**Allocation.** Region 2 countries set aside two big segments of their share of the equatorial orbit where BSS will rate as a primary service. This allocation assures the Latin-American nations that the skies of the Western Hemisphere won't get filled up with

fixed-service satellites put up by the U.S. and Canada before direct broadcasting comes of age. The segments are 75° to 100° west longitude (95° for services to the U.S., Canada, and Mexico) and 140° to 170° west longitude. In addition, each country in Region 2 is assured of getting a minimum of four channels when the region's frequency plan is stitched together in 1982.

During session breaks at the conference, systems costs—although not on the agenda—were on many delegates' minds. For a satellite alone, an official of the National Aeronautics and Space Administration hazarded an estimate of \$50 million to \$150 million. On top of that outlay come up-terminal costs and more money for receivers.

Receiver cost projections ranged from several hundred to several thousand dollars. Japan's public-broadcasting service, NHK, has developed a front end for 12-GHz color-TV reception that has an antenna only 2 feet in diameter and converts the fm signal from the satellite into an amplitude-modulated signal that can be fed to the antenna terminals of a standard cable-TV set. The target mass-production price is \$200.

But, even though the Japanese apparently have half the problem in hand, they are not yet ready to try beaming BSS directly to homes. The experimental system they have scheduled to start up next year will have community receivers with antennas of 1.6 meters diameter at the center of the beam and up to 4 meters at the fringes. □

**In action.** U. S. team at the World Administrative Radio Conference included (from right) Lee, Edward Reinhart, Neil McNaughton, Peter Sawitz, William Jahn, and Francis Urbany.



# WE'RE WARNING YOU...

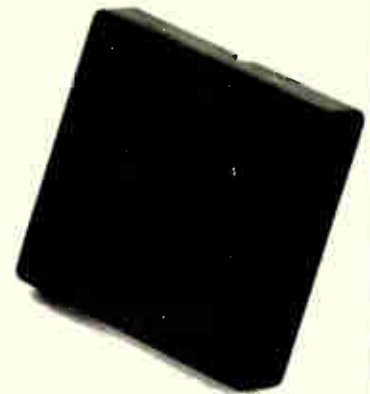
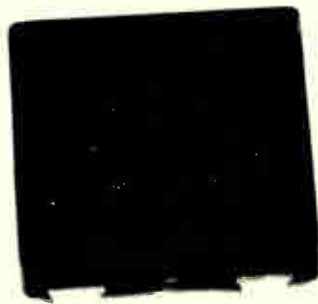

... these new audio indicators are just right for letting you know something's wrong. Ideal for computer terminals, remote control warning, fault detection and alarm devices. Six models ... featuring 35mm diameter piezo crystal ... rated to 85 dbA at 3.3 kHz ... 3 to 16 vdc, drawing just 10 mA maximum current. Supplied with .187 quick disconnect tabs, wires or PC mounting pins. Black ... 40mm square x 10mm high (X-10), or 15mm high (X-11). Life-tested for at least 1000 hours. Ask for free catalog.

Actual Size  
Series X-10 Continuous  
Series X-11 Pulsing

## Where to buy an audio indicator for every need



projects<sup>®</sup>  
unlimited

3680 Wyse Road, Dayton, Ohio 45414  
Tel. (513) 890-1918, TWX 810-450-2523  
*Distributorships and sales territories available.*

SWITZERLAND, ZURICH  
EGLI Fischer Co.  
Tel. 25 02 34

DENMARK, HERLEV  
Inotec A/S  
Tel. (02) 94 80 33

NETHERLANDS, ROTTERDAM  
Van Dam Elektronika  
Tel. 010 67 00 22

GERMANY, NORDERSTEDT  
WPB Digisound  
Tel. 040 522 3031

SOUTH AFRICA, DUNSWART  
Pace Electronic Components Ltd.  
Tel. 616-5303

FRANCE, PARIS  
Decelect Electronique  
Tel. 331 98 14

NORWAY, OSLO  
Henaco A/S  
Tel. (02) 15 75 50

ITALY, MILANO  
Forind-Avio S.r.l.  
Tel. 324 120

SPAIN, MADRID  
Diode Espania  
Tel. 455 01 40

Circle 197 on reader service card

## MDB SYSTEMS presents... The INTERDATA Connection

GP Logic Modules · Peripheral  
Controllers · Communications  
Interfaces · Special Purpose  
Modules · Accessory Hardware

New: PASLA and Universal  
Clock Modules.

MDB Systems products always equal and usually exceed the host manufacturer's specifications and performance for a similar interface. MDB interfaces are software and diagnostic transparent to the host computer. MDB products are competitively priced, delivery is usually within 14 days ARO or sooner.

Here are some MDB Systems connections to Interdata computers:

- General Purpose Interfaces  
Universal Logic Module provides handshake plus 92 wire wrap positions; handles two independent device controllers.
- G.P. Interface board; full wire

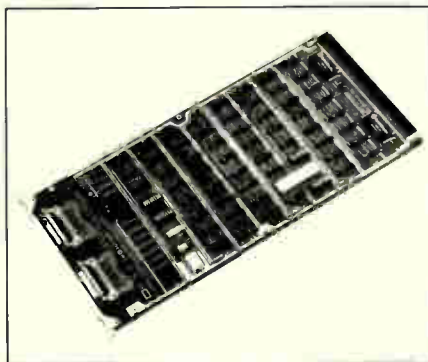

wrap with 197 socket positions.

- Universal Clock Module (includes line frequency clock).
- Line Frequency Clock Module.
- Communications Modules  
PASLA, programmable crystal controlled baud rate.  
Communications connectors mounted on rear edge of board (male and female, can be both terminal or data set). All addressing and speeds DIP switch

selectable.

Current Loop Interface for TTY device; multiple baud rate selection, one of sixteen, from 50 to 19.2K baud.

- Device Controllers for most major manufacturer's  
Printers  
Card equipment  
Paper tape equipment

All Controllers are software transparent using Interdata diagnostics.

Check first with MDB Systems for your Interdata computer interface requirements.

MDB also supplies interface modules for DEC PDP-11\* and Data General NOVA\* computers and for DEC's LSI-11 microprocessor.

# MDB

MDB SYSTEMS, INC.

1995 N. Batavia St., Orange, California 92665  
714/998-6900 TWX: 910-593-1339

\*TMs Digital Equipment Corp. & Data General Corp.

CIRCLE 198 FOR INTERDATA; 199 FOR PDP-11; 200 FOR NOVA; 201 FOR LSI-11.

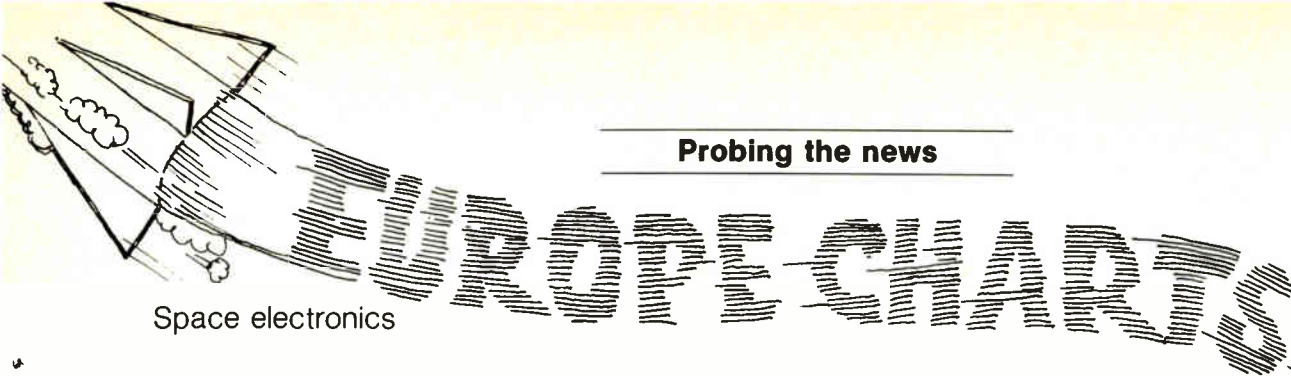

# EUROPE CHARTS

Space electronics

Top ministers of ESA nations decide to put agency into communications-satellite business as catch-up phase ends

by Arthur Erikson, Managing Editor, *International*

The Western European countries now have a pretty good idea of what their place in space will be by the mid-1980s. So far, they've been pressing to acquire the capability to put working satellites into orbit—all too often squabbling among themselves how best to do it. This catch-up phase of their space effort will be largely achieved by the end of this decade, and they have started planning for the "industrial" space era to follow.

To be sure, no one intends to match the programs of the U.S. or USSR. The European Space Agency estimates that spending for space projects by its 11 member countries last year totaled some \$750 million. In the U.S., the National Aviation and Space Administration's budget for the current fiscal year runs some \$3.7 billion, and the Defense Department also spends heavily for space programs. But the Europeans expect to meet their own needs for satellite systems by mid-decade and also pick up business from the Third World and international groups like Intel-sat.

Funded by contributions from its member states, ESA now writes the checks for about two thirds of the European space effort. The agency has budgeted some \$500 million this year and wants to hold at that level through 1980. But the spending for the two largest programs—the Ariane launcher and the Spacelab that will ride NASA's Space Shuttle—peaks this year. "We're trying to avoid a slump in funding like NASA had after Apollo," says Andre Lebeau, ESA's deputy director and chief planner.

ESA apparently will get the back-

ing it needs, even though most of its member countries—particularly Great Britain and Italy—are striving for austerity. At a mid-February space ministers' council, the first since ESA was formed 18 months ago by merging the launcher organization ELDO and the satellite organization ESRO, general manager Roy Gibson pitched for a commitment to a budget of a little more than \$1.5 billion for the three years ending in 1980. That is more than the ministers want to spend, but their response to the proposal left staff members optimistic.

Although the ministers decided nothing definite about money, they made two key commitments—to extend the ESA telecommunications program and to go on to a production phase for the Ariane launcher. That work must be started before the last of the four qualification vehicles is launched in 1980.

The council directed the agency to get Europe—not ESA itself—into the telecommunications-satellite business. Of the two resolutions the ministers passed during their mid-February meeting, one spelled out guidelines for the agency's role in managing full-fledged operational systems. One of the key clauses limits ESA's operation activities to the launching, placing in orbit, and orbital control of satellites or space-transport systems, and to the provision of technical assistance in the design and exploitation of systems, either to the users themselves or to a body designed by them. The state-run telecommunications administrations will probably operate Europe's future domestic-satellite systems.

By the end of 1980, Europe should

be ready to start using Arianes to launch at least two payloads a year. The first four qualification vehicles will go up in 1979 and 1980, and a batch of production models will follow. The first half dozen will be ordered in 1978 from France's space agency, the prime contractor, unless ESA's plans go considerably awry. Four will loft ESA satellites and two Third World satellites. ESA figures the Ariane can put a 900-kilogram payload into a geostationary and 4,000 kg into a low circular orbit. For solar orbits, the payload drops to 400 kg. Improved versions that would up these performance figures are, of course, a good possibility for later in the program.

As for the communications satellites, the first experimental models should be on orbit by mid-year. Known as OTS (for orbital test satellite), it will be followed early next year by a marine-communications version called Marots. A second Marots could well go up in 1979; it is on the list for the extended telecommunications program the ministers in mid-February approved in principle. Delta 3914 launchers will flash these three satellites into orbit. But in 1981, ESA plans to use its own Ariane to launch the first satellite for a European regional comsat system into orbit. □

# HP 9830A/B\* USERS.

## You're closer to the world's best desk top computer than you think!

By adding INFOTEK's field proven accessories, your 9830A/B will out-perform any other general purpose desk top system.

Completely compatible with all 9830A/B conventions, our units give your system a combination of speed and versatility superior to any other desk top computer... any make... any model.

The cost is a fraction of what you'd pay for any other approach offering similar capabilities.

### 32,192-Byte Memory

Where more memory is important, the user area may be increased to 32K bytes with our EM-30... the first and only 16,096-word memory for the 9830A/B! Compared to newly introduced models equipped with commonly used ROM options, the 9830A/B with the EM-30 provides 8,192 bytes more user memory. A truly significant increase in capacity!

With the 9830A/B, the EM-30 provides 2,048 more bytes of memory, is priced right, and is fully warranted for a year.

### FAST BASIC ROMS

Infotek's FAST BASIC ROMS add to the machine instruction set where HP left off. These ROMS provide spectacular increases in the work throughput of your 9830A/B. For example, you can process arrays at speeds of 40,000 words per second, attain an I/O capability of 10,000 bytes per second, greatly increase the power of a 9880A/B disk system, and print from a buffer while computing.

By providing 46 additional functions, statements, and commands, the FAST BASIC ROMS give your 9830A/B the most powerful BASIC language repertoire short of \$200,000 systems.

If you need FAST BASIC but don't have enough unused ROM slots, don't give up! You can install our FAST BASIC ROMS without losing any present capability. **Contact us, we'll show you!**

\*A Product of Hewlett-Packard Company



HP 9830A/B with the Infotek FD-30 Mass Memory

### Floppy Disk Memory System

The FD-30A provides 305K bytes of on-line data that can be searched 50 times faster than your present cassette system. Data throughput is actually four times faster than the 9880A/B Mass Memory. Best of all, no software modifications are required since the FD-30A obeys all cassette syntax.

The FD-30A is the optimum magnetic memory for the 9830A/B. It has the right capacity, speed, and price.

### Prices that you'll appreciate

EM-30 Memory, 16K Words	\$4,600	} net \$3,500
Less trade-in of HP 8K Words	1,100	
FAST BASIC I ROM	675	
FAST BASIC II ROM	525	
FAST BASIC I & II as a set	1,050	
FAST BASIC III ROM	525	
FD-30A Mass Memory	3,895	
FD-30S Slave Drive	1,780	
FD-30D Dual Drive System	4,900	
RS-30 High Speed RS232C Interface	750	
RC-30 Real Time Clock	825	
LP-30 Heavy Duty Line Printer	6,850	
CP-30 Character Printer	3,400	
PS-30 Paper Tape Punch/Reader	3,850	
BP-30 Interrupt Service Printer I/O	525	
FI-30 10K Byte/Sec TTL I/O	395	

All Prices Are U.S. Domestic

**NEW!** The FD-30S low cost Slave Drive for the FD-30A. Multiple slaves can be used with a single FD-30A so you can increase on-line capacity in blocks of 305K bytes. Also, the FD-30S provides one minute disk duplication under program control or stand-alone.

**NEW!** BP-30 automatic buffered printing. Your '30 will **continue program execution** while driving a printer as a background task under interrupt control.

### Save \$2,100

In our Word Processing Package you get the EM-30, FD-30A, FAST BASIC I and III ROMS, and the CP-30, including software, for a special package price of \$10,850.

### Other 9830A/B Accessory Equipment

**RS-30 High Speed RS232C Interface.** Provides seven crystal controlled Baud rates from 150 to 9600/sec.

**TC-30 Real Time Clock.** Provides time in 10-millisecond increments, is set or read via the OUTPUT and ENTER statements.

**LP-30 Heavy Duty Line Printer.** A 200 line-per-minute, 132-column printer (128 character set is standard). Comparable in every way to the 9881A, except the LP-30 is lower in price.

**CP-30 Correspondence-Quality Character Printer.** Provides 14 easily changeable fonts including scientific symbols, UK, German, Scandia, and Cyrillic. Prints and plots at 45 cps

Contact us direct or through our representatives. Infotek products are sold and serviced through 33 offices in the U.S. and 11 in other countries.

Let us show you how to make your '30 the best desk top computer in the world.



## Infotek Systems

1400 N. BAXTER STREET • ANAHEIM, CALIF. 92806  
(714) 956-9300 • TWX 910-591-2711

U.S. and Worldwide Distributor Inquiries Are Invited.

Computers

# Encryption standard protects data

Semiconductor makers expect major market in devices, as Fairchild, Rockwell, and Motorola get early start

by Ray Connolly, Washington bureau manager

As the use of computers—and the wealth of data they contain—have grown, so have the fears of governments, businessmen, and private citizens that important information concerning their operations or lives would fall into the wrong hands. Now the National Bureau of Standards has moved to allay those fears with the adoption of the first data encryption standard for government and industry use.

Makers of semiconductors and communications equipment see the standard as the source of a major new market when it is officially implemented on July 15. "It will probably be one to two years before

a full range of devices is widely available," estimates Dennis Branstad, project leader for the standard. "Then the market will build from there."

Even as NBS and Government computer users detailed plans for implementing the new data encryption algorithm during a mid-February conference, three electronics manufacturers were already moving on the hardware market. Fairchild Semiconductor disclosed plans for using its new, high-speed 9414 Isoplanar integrated injection logic chip [*Electronics*, Feb. 17, p. 82] for the job. Motorola Semiconductor indicates it will employ its M6800

security module, scheduled to become available in small quantities in April, for the task. Rockwell International's Collins Radio is working on yet another large-scale-integrated approach that Branstad describes as "a fully-buffered input, compute, and output device in which the input-output provides simultaneous encryption and decryption."

Fairchild's 9414, which evolved from classified military programs at its Syosset, N.Y., Space and Defense Systems division, is scheduled for sample distribution later this year, says Krishna Rallapalli, advanced products manager. Using what NBS's Branstad calls "a very innovative approach," Rallapalli says the 9414 uses four "identical" bit slices measuring 125 mils on a side to achieve greater reliability and lower cost in production than could be achieved by putting all functions on a single 350-mil chip. Each chip will use two 8-bit shift registers for error detection, while the remaining four will be used for code key.

Motorola's medium-speed M6800 security module for microprocessor interfaces uses a simpler approach, says Branstad, which the company believes will be adequate for the foreseeable market. The 9-by-6-inch board contains the MC6800 microprocessor package plus all buffering and an optional erasable read-only memory for storing keys or smart address control. Keith Warnable of Motorola's Data Security Devices operation says it can be used in block or cipher-feedback modes.

**Origins.** Development of the 64-digit algorithm employed in the standard formally known as FIPS PUB 46 (Federal Information Processing

## Who sets the standards?

While the National Bureau of Standards has employed an IBM concept to develop its new data encryption standard, computer users are already looking for a standard-setter for hardware to guarantee compatibility and interchangeability of parts. Some of those problems are already being addressed by the American National Standards Institute. Government computer users are likely to be the earliest and largest users of the encryption standard, an even larger influence can be expected to come from the Federal Telecommunications Standards Committee, a group that is composed of representatives from diverse agencies.

While the committee is struggling with hardware standards, the Federal Reserve Board's Howard Crumb says it will begin testing devices using the algorithm by mid-1977 with an eye to measuring its operational impact and crypto-key-management and storage approaches. Meanwhile, Jack McDonnell of the National Commission on Electronic Fund Transfers says the commission will recommend technical guidelines for EFT, including implementation of the standard, to the Congress by the end of the year.

One of the earliest tests will come with the standard's use by the Pentagon's Advanced Research Projects agency, whose ARPA network decided to test the encryption algorithm in 1975, long before its adoption, according to Stephen Walker, ARPA's program manager for network security. The Arpanet will employ 13 encryption control units between each terminal used in the test, including the key management facilities. These units, developed by Collins Radio, will use two Digital Equipment Corp. LSI-11 microprocessors for encryption control at each terminal plus a PDP 11/40 for system control and as a key distribution center.



# Records in record time.

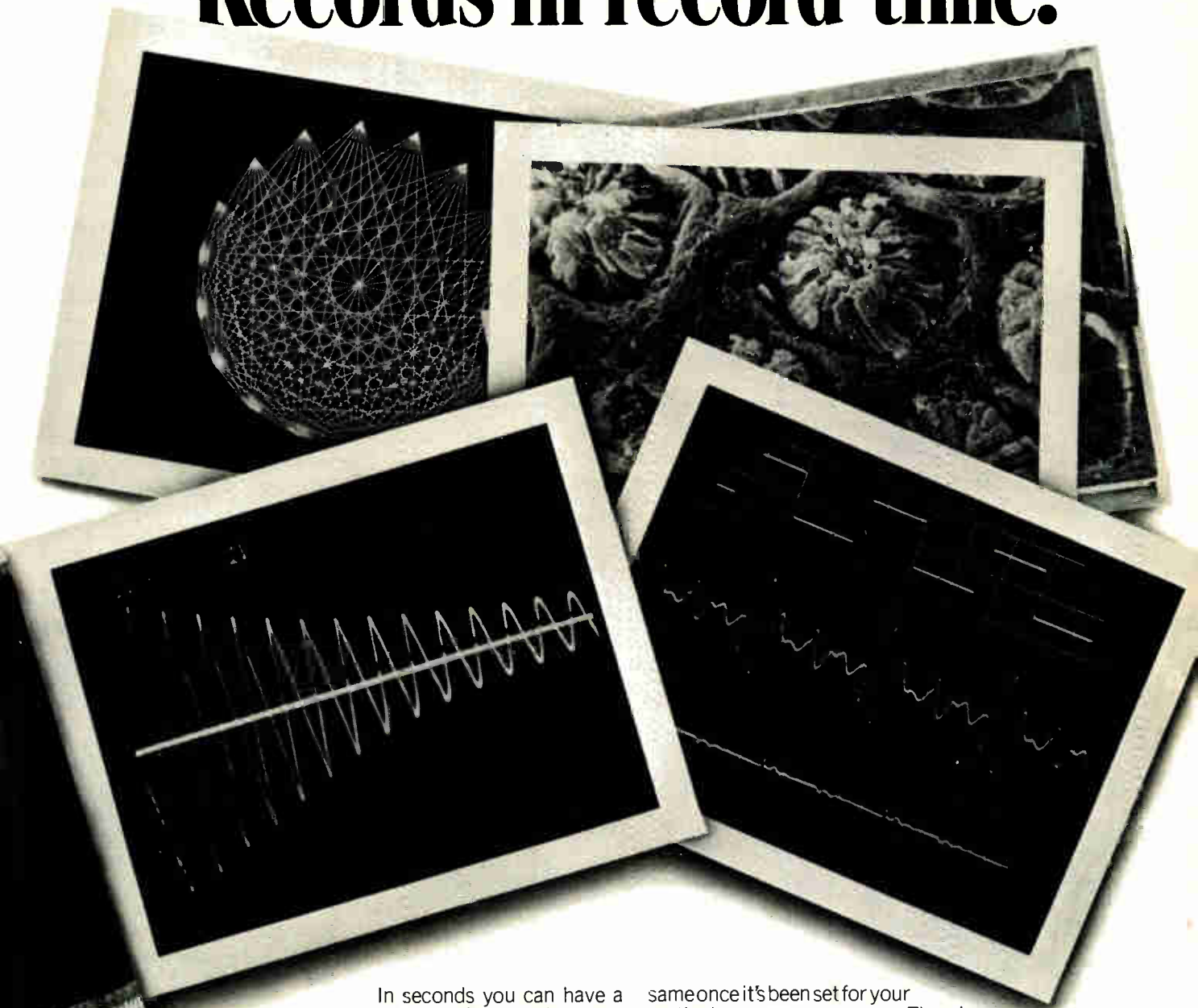

In seconds you can have a permanent copy of your cathode ray tube display with Polaroid's CU-5 Hard Copy Land Camera. Whether you have a computer terminal, an oscilloscope, a closed circuit TV or scanning electron microscope, you'll get economical 3¼ x 4¼ inch (8.3 x 10.8 cm) photos for study, comparison, pass-along information, reproduction or filing.

Whatever size screen you have, we can probably fit it with the proper hood. Whatever your film needs (black and white, positive/negative, color), Polaroid makes a professional pack film to fill your needs.

You don't have to know a thing about photography to use the CU-5. The exposure setting always remains the

same once it's been set for your particular screen or scope. There's no focusing. All you do is hold the CU-5 with a CRT hood against the display you want copied, squeeze the trigger-like shutter release and you've recorded instantly the data without tying up your terminal.

If you're interested we'll direct you to your nearest Polaroid Professional Products Dealer. Return the coupon or call Polaroid toll free: 800-225-1618 (in Massachusetts, call collect: 617-547-5177).

Polaroid Corporation, Dept. A360,  
575 Technology Square, Cambridge, Mass. 02139  
I'm interested in Polaroid's CU-5 for CRT recording.

Name \_\_\_\_\_  
Company \_\_\_\_\_  
Address \_\_\_\_\_  
City \_\_\_\_\_  
State \_\_\_\_\_ Zip \_\_\_\_\_  
Telephone \_\_\_\_\_

**Polaroid**  
*The CU-5 Camera for CRT  
image recording in seconds.*



# BYTE

The Small Systems Journal

## Isn't it time you had your own personal computer?

Read BYTE, the leading national publication covering the fantastic new field of personal computer applications. Today, large scale integration has made it possible for the individual to enjoy the unique benefits of a general purpose computing system. Now, an entire micro industry markets microcomputer related items, products that range from computer system kits to peripherals, software and literature on the subject. But where should you go for all the details about your personal involvement in computer technology?

Read BYTE, the Small Systems Journal devoted exclusively to microcomputer systems. Every issue a monthly compendium of lively articles by professionals, computer scientists, and serious amateurs.

Fill in subscription coupon today, or phone your request directly — call 603/924-7217 and ask for subscription department. Read your first copy of BYTE, if it's everything you expected, honor our invoice. If it isn't, write 'CANCEL' across invoice and mail it back. You won't be billed and the first issue is yours.

Allow 4 to 6 weeks for processing.

**BYTE** 70 Main St., Peterborough, N.H. 03458 20A3

Please enter my subscription to BYTE...

\$12 One Year       \$22 Two Years       \$30 Three Years

Bill me       Check Enclosed

Bill BankAmericard       Bill Master Charge

Credit Card Number

Credit Card Expiration Date

Name (Please Print)

Address

City  State  Zip

Circle 202 on reader service card

## ANALOG I/O SYSTEMS. FOR INTEL SBC 80, DEC LSI-11, CA LSI-2 & 3, NATIONAL SEMI IMP & PACE, PCS SUPERPAC, ZILOG MCB...

DATA TRANSLATION is the world's Leading Developer of Analog Systems for Microcomputers. We offer:



- Complete Single Board Analog Interfaces
- Test & Calibration Software Shipped with each System
- Analog FSR from 10mV to 10 V at 12-bits
- High Speed, Industrial D/A Outputs (4 to 20 mA)
- Prices Start at \$295

CALL the Company dedicated to your needs for Microcomputer Analog I/O Systems at (617) 655-5300. A Complete set of Applications Data is available.

# DATA TRANSLATION INC

23 Strathmore Rd., Natick, MA 01760/(617) 655-5300 Telex 948474

## Probing the news

Standards Publication 46) is credited to International Business Machines Corp., which has granted non-exclusive, royalty-free licenses for the manufacture, sale, and use of hardware employing it [*Electronics*, Dec. 23, 1976, p. 42]. But NBS specifies that implementation of the standard must be in hardware, rather than software, and employ chips using LSI technology, medium-scale integration components, or other devices such as read-only memories or microprogrammed units using microcode for hardware control.

Bringing the data encryption standard into the workaday world of markets like electronic funds transfer—where it is expected to answer many criticisms of potential invasion of privacy—still requires substantial effort, however. Burroughs Corp.'s Ed Lohse warned the NBS conference that standardization of parts like LSI chip pinouts and power dissipation will be critical to the success of device interchangeability. Similarly, data rates and communications interfaces must be meshed.

**Links.** Levels at which encryption takes place also was a major topic at the meeting at NBS's Gaithersburg, Md., headquarters. Link-by-link encryption, where devices incorporating the algorithm are placed in series with the circuit between a terminal and the communications equipment, is most commonly used today. But it is limited by letting data traffic pass through any node of a system in plain text. Node-by-node encryption, in which each line uses a unique key and "translation" from one key to the next occurs in a peripheral security module is considered promising.

But Interbank Card Association's Carl M. Campbell Jr. believes end-to-end encryption appears to be the obvious choice for systems where conversations are relatively long, as in the military. Such encryption uses a key control center in the communications link that can be reached by each of a system's terminals through its own key. The key control center then verifies a terminal's authority to communicate with others and generates a temporary key for that particular communication. □

# WE DON'T MAKE TERMINALS!

## But, we make it a heck of a lot easier for you to make them!

Now, with SMC's standard computer peripheral MOS/LSI circuits, most standard peripheral functions can be "plugged-in". Design is easier. Products are more reliable. Assembly is faster - and that keeps costs down.

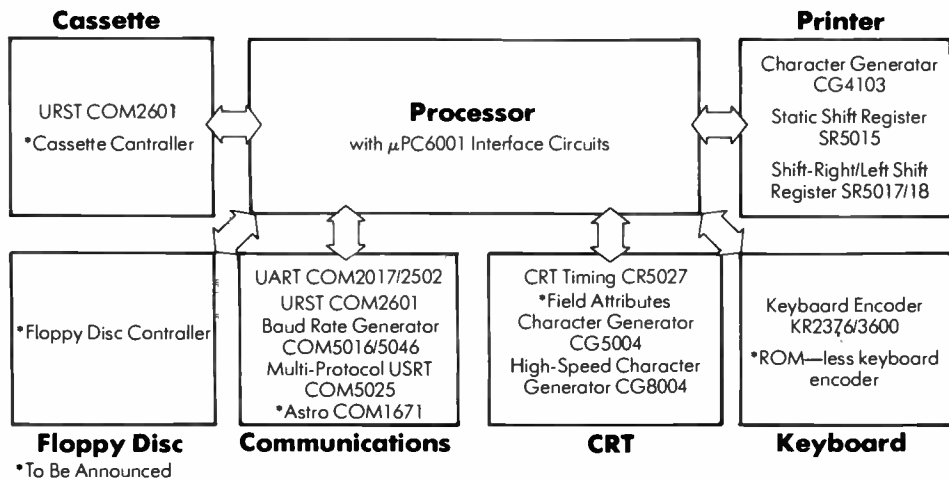

For complete technical information, call or write:



**Standard Microsystems Corporation**

35 Marcus Boulevard, Hauppauge, N.Y. 11787  
(516) 273-3100 TWX-510-227-8898

# 热烈欢迎 西德朋

Electronics abroad

## Chinese put priority on semiconductors

by John Gosch, Frankfurt bureau manager

Although not yet a factor in world markets, the People's Republic of China is making big strides in electronics technology, particularly in semiconductors. It is producing MOS-memory circuits with good yields and has made semiconductor lasers that can operate at room temperatures for more than 5,000 hours. It is also intensively investigating magnetic-bubble memories and other sophisticated devices.

These observations were made during a three-week tour of China by Hans-Joachim Queisser, director of the Max Planck Institute for Solid State Research in Stuttgart, West Germany. He and four other German researchers were guests of the Chinese Academy of Science.

"Semiconductor electronics," Queisser reports, "is a top-priority endeavor in China, and work in solid state is being pushed at universities and by the academy at the expense of many other fields in physics." Many small electronics factories are producing transistors, integrated circuits, and other components. Significantly, the institutes, universities, and factories cooperate closely, and "there is little duplication of effort at the various facilities," says Queisser, a former associate of transistor co-inventor William Shockley.

So far, a relatively small output, lack of automated techniques, and high component costs have prevented China from entering world markets. But Queisser, for one, does not

quarrel with Western sources who put China among the world's top 10 electronics producers and who see the nation of 750 million challenging the Soviet Union and West Germany in a few years. China watchers peg the country's 1974 electronics output at \$2 billion.

No basics. As for fundamental research, however, "in the western sense it is virtually nonexistent in China," Queisser says. The emphasis is almost wholly on semiconductor development. Even the institutes associated with the Chinese Academy of Science are devising fabrication methods and making components and crystal materials—in some cases on pilot production lines that, Queisser concedes, are technically superior to those at West German universities.

Peking is the center of a lot of activity in electronics. For example, the Chinese science academy's Semiconductor Institute there is working on gallium-arsenide crystal growth, liquid epitaxy, luminescence, and material analysis by spectroscopy, and it has silicon and GaAs microwave diodes as well as MOS devices in pilot production. Then, too, the semiconductor department of the Peking-based Institute for Physics is engaged in solid-state laser work, as well as artificial diamond, spinel, and garnet fabrication and experiments with bubble memories. Tsinghua University, also in Peking, is fully equipped to produce and test

MOS devices such as 1,024-bit p-channel memories.

Also active in the MOS field is Nanking University's Institute for Physics, now primarily engaged in semiconductor work. It has charge-coupled devices like shift registers in pilot production and is involved in transistor-transistor-logic device development, material analysis, and experiments with silicon-on-sapphire components.

In Shanghai, at the academy's Institute for Metallurgy, Queisser witnessed work on GaAs materials and components, field-effect transistors, and Schottky diodes.

Canton's Sun Yat-sen University is producing silicon varactors, developing sputtering techniques, and experimenting with nitrides with a view toward metal-nitride-oxide-semiconductor components.

But some areas are neglected in China. Among them are microprocessors, glass fibers, and certain other fields of optoelectronics.

**Equipment.** At the disposal of Chinese development engineers is a large array of production apparatus, instruments, and test equipment: microwave testers, evaporation and sputtering apparatus, multichannel analyzers, oscillographs, and vacuum equipment with helium-leakage detectors and oil-less pumps. All equipment is of Chinese origin, and that, Queisser says, "particularly amazes a West German" used to imported equipment in his own lab.

What also struck Queisser is the relatively high technical level of some production and test equipment. Examples he cites are exposure machines with a  $\pm 1$ -micrometer resolution over the wafer, dual-trace sampling oscillographs rated at 1 nanosecond per division and 10 millivolts per centimeter, and high-precision controllers said to be capable of regulating diffusion oven temperatures to within  $\pm 0.1^\circ\text{C}$  at  $1,100^\circ\text{C}$ .

Hard work at semiconductor facilities seems to be the order of the day. One factory that Queisser visited employs some 800 people in two, and sometimes three, shifts. Work on Sundays is not uncommon, and, what with automated or computer-supported mass-production techniques all but nonexistent, manual labor is very much in evidence. □

# ANOTHER VINTAGE YEAR FOR CHERRYS

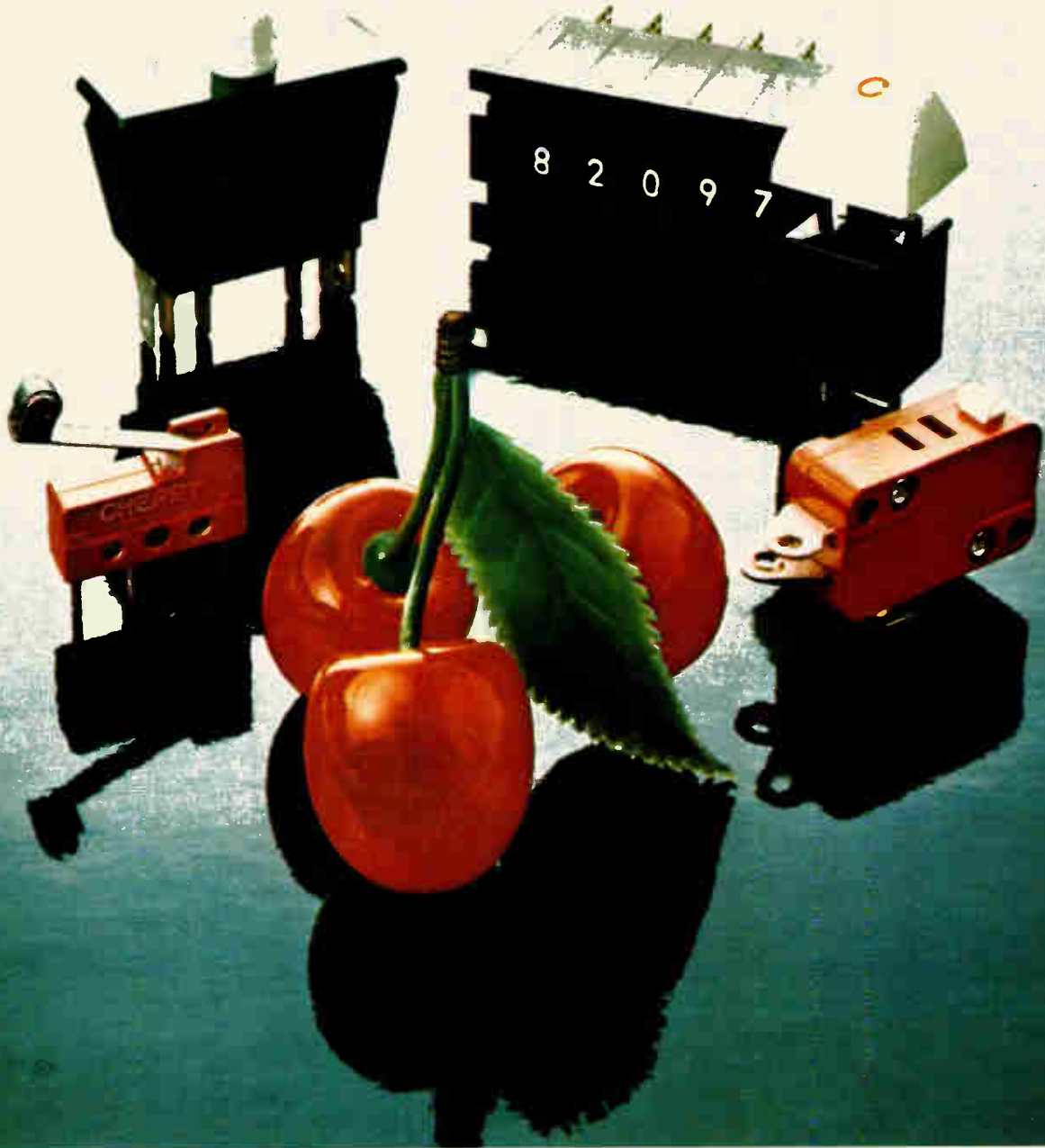

We planted the seeds for these Cherrys 25 years ago. Today they're the pick of the switching crop. Good, sturdy, hardworking switches with years of know-how, experience and refinement behind them . . . and a bright future ahead.

**What kinds of switches? You name it, Cherry's got it.** Snap-action switches with unique Cherry coil spring mechanism for long mechanical life. Gold crosspoint contact switches for low energy solid state circuits. Thumbwheel switches in a full range of alphanumeric readouts and output codes. Individual keyboard switches and complete keyboard assemblies with electronics. Rotocode® switches . . . a new rotary switch with coded electrical output.

**If your products are made or sold overseas** you'll be glad to know that Cherry's switches are available worldwide from our modern manufacturing plants in the USA, England, Germany and Japan and a licensee in Australia. All our switches have passed rigid performance requirements of independent testing laboratories. Many of our switches have been listed, certified or approved by various international testing and approval agencies.

**Check the complete crop of Cherry switches.** Ask for our latest 84 page catalog. For immediate action just phone (312) 689-7700.

# CHERRY



**CHERRY ELECTRICAL PRODUCTS CORP.**  
3608 Sunset Avenue, Waukegan, Illinois 60085

**SWITCHES and KEYBOARDS — Available locally from authorized distributors.**



# Because of an LSI-11 microcomputer, when this woman speaks, her computer listens.

Since EMI Threshold Ltd.'s introduction of the voice-input computer terminal, man and computer have begun a totally new relationship. A speaking one.

Their EMI Threshold 500 terminal actually allows people to talk to their computers just like they talk to their other co-workers.

At the heart of the EMI Threshold 500 is the highest performance, most software-supported microcomputer on the market. The LSI-11.

For Bob Cox, Chief Engineer at EMI Threshold Ltd., anything less wouldn't have been enough.

"At first we offered our voice-input terminal using a mini. But that put the price of the system too high — a price that was way out of line with a lot of applications. So to cut costs, we

developed our own micro from chips. Then the LSI-11 came out. Right off, we knew it was the answer.

"By incorporating the LSI-11 into our system, a lot of good things started happening.

"First, the price was reduced by 45%. We were also spared the time and capital investment involved with setting up manufacturing facilities for a micro, as well as all the testing and support services we would have to provide.



Bob Cox, Chief Engineer at Threshold Technology, Delran, New Jersey

"The fact was that the LSI-11 cost no more than the micro we had designed ourselves. Best of all, we were getting a computer that performed just as effectively as the mini we had used before. Solutions don't come much better than that."

For a lot of applications — like EMI Threshold Ltd.'s and perhaps your own — anything less than the LSI-11 isn't really enough. Why not ask us more about it.

We're as easy to talk to as our computer.

For 600 pages of solid technical information, plus our new brochure of microcomputer case histories, "Why Anything Less than the LSI-11 Wasn't Enough for Me," write to Digital Equipment Corporation International, 81 Route de l'Aire, 1211 Geneva 26, Tel. 42 79 50.

**digital**  
**COMPONENTS**  
**GROUP**

# The Electronics Book Series offers you:

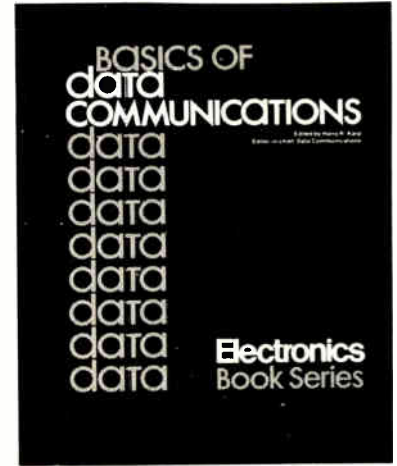
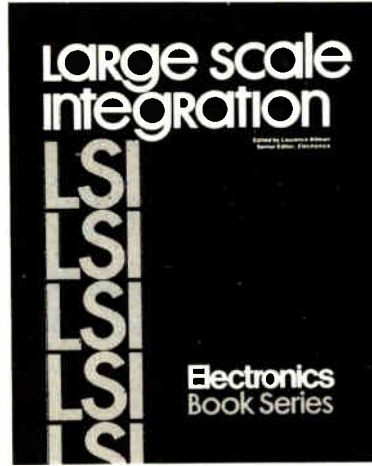
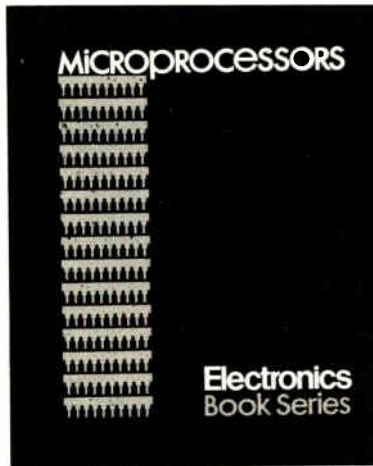

## 1 MICROPROCESSORS

The microprocessor has permanently changed the methods of designing and building electronic equipment—from process and industrial control to computer-based designs in instruments communication and consumer/commercial equipment.

This book cuts through the confusion, presenting the design and application potential of this exciting technology in a manner that will appeal to the design engineer who needs to know how to use microprocessors as well as the system analyst who must assess the tradeoffs between microprocessors and other techniques to accomplish his system goals.

Using articles from the pages of Electronics, this book contains practical and up-to-date information on available microprocessor devices, technology and applications.

## 2 LARGE SCALE INTEGRATION

The Electronics Book Series offers you a handbook on the current and revolutionary impact of LSI on digital design. This 220-page book presents a unique opportunity for circuit designers, systems designers, and engineering managers and supervisors to bring their expertise into line with today's LSI design requirements.

"Large Scale Integration" is a compendium of recent articles published in Electronics. Although in some ways it is a companion piece to "Microprocessors" because it explains the new circuits that play in mp systems, it is much more. "Large Scale Integration" deals with the entire range of design applications: main memory systems, peripheral memories, memory controllers, on-line industrial controllers, data acquisition boards, communication systems, calculators, watches, etc.

## 3 BASICS OF DATA COMMUNICATIONS

Data communications is one of the fastest-growing electronic equipment markets in the U.S.—during the decade of the '70's, better than 15-20% per year, compounded!

Chances are you are going to be a part of the data communications market. There's no better place to start than getting a copy of "Basics of Data Communications"—a 316-page compilation of essential articles which have appeared in Data Communications magazine. From the basic, tutorial, still state-of-the-art information published in the 1972 and 1973 Deskbook issues (now out of print), on through information on the practice of present-day data communications, this book includes forty-seven articles covering more than eleven key areas.

**Electronics Book Series** • McGraw-Hill Publications Co., Shoppenhangers Rd., Maidenhead, Berkshire SL62QL, England.



- 1  Send me \_\_\_\_\_ copies of "Microprocessors" at \$8.95 per copy.
- 2  Send me \_\_\_\_\_ copies of "LSI" at \$9.95 per copy.
- 3  Send me \_\_\_\_\_ copies of "Basics of Data Communications" at \$12.50 per copy.

Discounts of 40% on orders of ten or more copies of each book.

I must be fully satisfied or you will refund full payment if the books are returned after ten day trial examination.

Payment enclosed       Bill firm       Bill me

Name \_\_\_\_\_  
 Title \_\_\_\_\_  
 Company \_\_\_\_\_  
 Street \_\_\_\_\_  
 City \_\_\_\_\_  
 Country \_\_\_\_\_  
 Signature \_\_\_\_\_

**Credit Cards** Charge My Book To: \_\_\_\_\_

American Express       Diners Club

Acct. No. \_\_\_\_\_

Date Card Expires \_\_\_\_\_



# RACAL RECORDING TECHNOLOGY GUARANTEES ACCURACY OF REPRODUCTION.

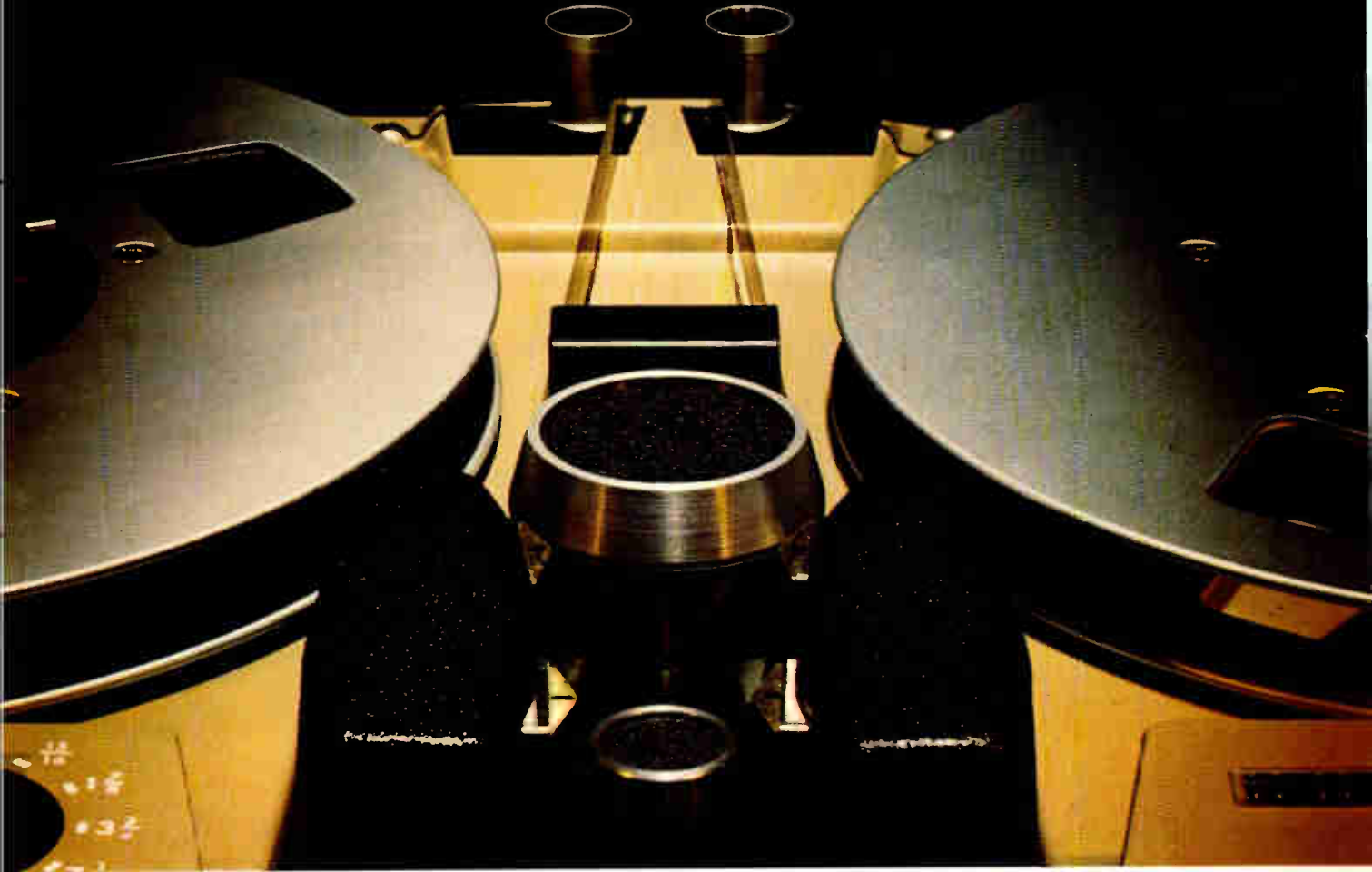

Throughout the world, hundreds of Racal "Store" instrumentation tape recorders faithfully record and reproduce vital data with precision, sensitivity and reliability. There are users in many different fields, including scientific research establishments, medical "intensive-care" units, and companies in chemical, geological and civil engineering.

Store recorders have 4, 7 or 14 tracks, for FM and Direct Recording Replay at frequencies up to 300kHz. Store 4 and Store 7 (which is IRIG compatible) can have any combination of FM or Direct Recording Replay cards—by simply plugging in the appropriate PCB.

FM frequency range is DC to 20kHz, with a signal-to-noise ratio better than 55dB—even at low speeds, under vibration conditions. This performance is achieved by a unique tape handling system, which incorporates a tape tension transducer and a servo capstan drive. These ensure perfect tape alignment and accurately meter tape speed.

Such critical accuracy of tape control means that Store recorders can be used in any environment; not only in laboratories, but in vehicles, aircraft, helicopters, ships.

In fact, wherever data has to be recorded and reproduced with absolute dependability.

Standard features of all Store recorders include: 7 record/replay tape speeds, from  $1\frac{5}{16}$  in to 60 in per second (each speed having full electrically-switched filters) • off-tape servo speed control • voice notation • remotely-programmable tape deck controls • unique calibration facility • input signal monitor • switchable flutter compensation, for improved signal-to-noise at low speeds • operation from AC or DC • compact, lightweight case, for easy portability.



**RACAL**  
The Electronics Group

Racal-Thermionic Limited  
Hardley Industrial Estate  
Hythe, Southampton  
Hampshire, SO4 6ZH  
Tel: Southampton (0703) 843265  
Telex: 47600

**Racal-Thermionic** the recording people

Circle 203 on reader service card

World Radio History

# If you're not now in the fast-growing data communications equipment market, chances are you will be.

*Data communications* is one of the fastest-growing electronic equipment markets in the U.S.—during the decade of the '70's, better than 15-20% per year, compounded!

Manufacturers of data processing equipment have recognized the unique nature of *data communications* and have established profit centers to pursue the market for *data communications equipment*. IBM, Burroughs, Sperry-Univac, Honeywell and Digital Equipment Corp. are just a few of the major data processing companies who have separate marketing arms for *data communications*, complete with new products, sales forces, etc. The Bell System, too, through its Teletype Corp., Bell Labs, and Western Electric, has introduced new *data communications equipment*.

Chances are you are going to be a part of the data communications market. There's no better place to start than getting the flavor of the marketplace, equipment, and services than from a copy of "*Basics of Data Communications*".

"*Basics of Data Communications*" is a 316-page compilation of essential articles which have appeared in *Data Communications* magazine. From the basic, tutorial, still state-of-the-art

information published in the 1972 and 1973 Deskbook issues (now out of print), on through information on the practice of present-day data communications, this book includes forty-seven articles covering more than eleven key areas.

"*Basics of Data Communications*" was edited by Harry R. Karp—Chief Editor of *Data Communications* magazine. It is the only book of its kind available anywhere that deals with practical aspects of data communications.

**Available this month.**

**Price: \$12.50**

Discounts of 40% orders of ten copies or more.



## Electronics Book Series

PO Box 669, Hightstown, N.J. 08520

Send me \_\_\_\_\_ copies of "*Basics of Data Communications*" at \$12.50 per copy.

I must be fully satisfied or you will refund full payment if the books are returned after ten day trial examination.

Payment enclosed       Bill firm       Bill me

### Credit Cards Charge My Book To

American Express       Master Charge

Diners Club       BankAmericard

Acct. No. \_\_\_\_\_

Date Card Expires \_\_\_\_\_

Interbank No. \_\_\_\_\_

(1st No's. above name on Mastercharge only.)

Name \_\_\_\_\_

Title \_\_\_\_\_

Company \_\_\_\_\_

Street \_\_\_\_\_

City \_\_\_\_\_

State \_\_\_\_\_ Zip \_\_\_\_\_

Signature \_\_\_\_\_

**Electronics  
Book Series**



# TRIO®



## Which one do you select? Oscilloscope CS-1500 Series

The demands for low cost oscilloscopes are now in remarkable growth. No one can ignore the popularity of those oscilloscopes because of the price, variety of different models, and above all availability everywhere. However stop to think it! Naturally, the reliability and stability limits their applications, and then creates dissatisfaction in many cases. From such point

of view, We started developing our oscilloscopes by utilizing the full know-how that we accumulated in years of experience. We are now proud of offering you the inexpensive CS-1500 Series having variety of features and reliability. As the results of market reaction, the Four Models are enjoying remarkable demands not only in Japan but throughout the world.

### 15 MHz Oscilloscope CS-1560A

- 130mm CRT
- DC-15MHz / 10mV
- Automatic sweep (AUTO FREE RUN)
- Display modes (CH1 CH2 DUAL ADD SUB)
- Full sensitivity X Y operation

### 10 MHz Oscilloscope CS-1559

- 130mm CRT
- DC-10MHz / 10mV
- Automatic sweep (AUTO FREE RUN)

### 30 MHz Oscilloscope CS-1570

- 130mm mesh PDA
- DC-30MHz / 5mV
- Delay line
- Auto level triggering
- Display mode: (CH1 CH2 DUAL ADD)
- Trigger modes (AC LF Rej HF Rej DC)

### 10 MHz Oscilloscope CS-1562

- 130mm CRT
- DC 10MHz / 10mV
- Automatic sweep (AUTO FREE RUN)
- Display modes (CH1 CH2 DUAL)
- Full sensitivity X Y operation

**TRIO-KENWOOD CORPORATION**

TEST INSTRUMENT DIVISION

21-24, 3-CHOME, IKEJIRI, SETAGAYA-KU, TOKYO 154, JAPAN

CABLE: TRIOINSTRUMENT TOKYO, TELEX: 242-3446 TRITES

UNRETOUCHED

# MICROPHOTOS



**Robinson-Nugent**  
**WORLD WIDE DISTRIBUTORS**

**Australia** General Electronic, Sidney . 439 2488  
**Austria** Compex, Vienna . . . . . (02243) 66-254  
**Belgium** Mulder-Hardenburg,  
 Brussels . . . . . (031) 68-70-20  
**Canada** E. G. Lomas Ltd.,  
 Ottawa . . . . . (613) 725-2177  
**Canada** Bowtek Electric,  
 Vancouver . . . . . (604) 736-1141  
**Canada** Bowtek Electric,  
 Edmonton . . . . . (403) 426-1072

**Canada** Bowtek Electric,  
 Winnipeg . . . . . (204) 786-7521  
**England** Astralux Dyamics,  
 Brightlingsea . . . . . (0206-30) 2571/5  
**Finland** Into OY, Helsinki . . . . . 11-123  
**France** A2M, Paris . . . . . 603-66-40  
**Germany** Comtronic, Munich . . . . . 643011  
**Germany** Deltrona, Stuttgart . . . . . 07151/51051  
**Israel** STG International, Tel-Aviv . . . . . 53459  
**Italy** De Mico, Milano . . . . . 653 131  
**Japan** Pan Electron, Yokohama . . . . . 045-471-8811

**Netherlands** Mulder-Hardenburg,  
 Amsterdam . . . . . 023-319184  
**Norway** Hans H. Schive, Oslo . . . . . 55-76-92  
**South Africa** Future Electronics,  
 Johannesburg . . . . . 788-1750  
**Spain** REMA Leo Haag, Madrid . . . . . 2 53 40 03  
**Sweden** Svensk Teleindustri,  
 Stockholm . . . . . 08-890435  
**Switzerland** Electronic Components,  
 Geneva . . . . . (022) 431531

# expose 'junk' socket problems

## **Secret of RN high reliability** **'side-wipe' DIP sockets** **revealed by microphotos**

Here's microscopic proof that high reliability Robinson-Nugent "side-wipe" DIP sockets make 100% greater contact than any edge-bearing socket on the market. This advance design provides constant low contact resistance, long term dependability—trouble-free IC interconnects. Yet RN high reliability DIP sockets cost no more than ordinary sockets!

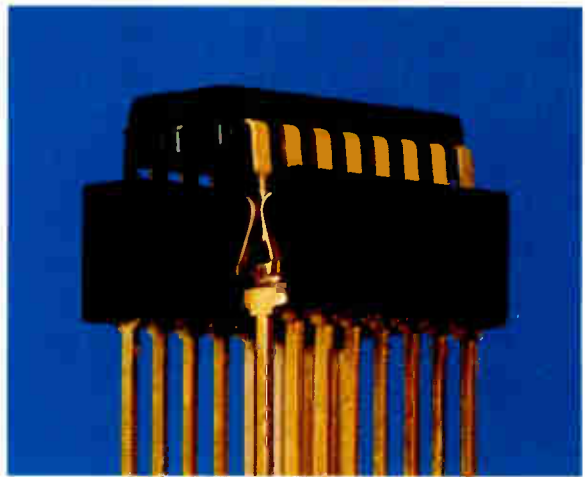

**Get the high reliability that eliminates trouble.** RN "side-wipe" DIP sockets make contact with the wide, flat sides of your IC leads. You get 100% greater surface contact for positive, trouble-free electrical connection.



**They're even packaged for high reliability.** "Protecto-pak"<sup>®</sup> packaging delivers consistently perfect RN sockets to your production line—for automated or manual assembly.



### **WRITE TODAY**

for catalog and informative book "What to Look for in IC Interconnects." Free from Robinson-Nugent—the people who make more kinds of high reliability IC sockets than anyone.

# **RN** EUROPE, S.A.

ROBINSON-NUGENT EUROPE, S.A./Rue Victor Allard 191/1180 Bruxelles, Belgium/Phone: (02) 377-27-44/Telex: 62432 RN-EUR  
Circle 87 on reader service card

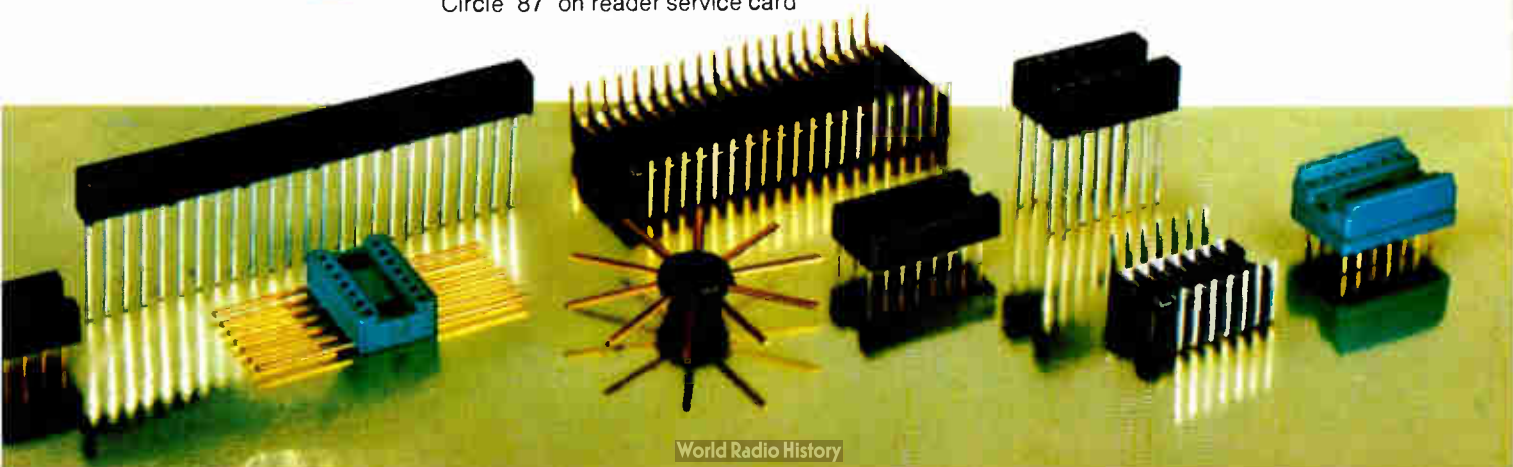

The sweep signal generator world has a new leader to look up to. Model 2002 sweeps from 1 to 2500 MHz in four bands. Or it can sweep the entire range using the band stacking option. It has more flexibility than any broadband sweeper

we've made, along with +13 dBm output,  $\pm 0.5$  dB flatness, 0.005% marker accuracy, and  $\pm 1\%$  display linearity. Look at the Model 2002 from any angle and you'll become a follower. Send us \$2700 and you'll become an

owner. Circle our reader service number for details. WAVETEK Indiana Incorporated, P.O. Box 190, Beech Grove, Indiana 46107. Telephone (317) 783-3221. TWX 810-341-3226.

**WAVETEK®**

# The new 2002 will sweep you off your feet.



Circle 88 on reader service card



# Hexadecimal signatures identify troublespots in microprocessor systems

by Gary Gordon and Hans Nadig, *Hewlett-Packard Corp., Santa Clara, Calif.*

□ The number of microprocessor-based products manufactured each month is approaching the total of all installed computers and minicomputers, raising the question: "How will they be serviced?" Traditional digital servicing, in which defective modules are swapped for good ones, creates substantial inventory and handling costs. A much more economical alternative is a new technique called signature analysis, with which a product can readily be serviced down to the component level.

Signature analysis is based on the time-honored technique of signal tracing. When its requirements are designed into a product, a new test instrument can map

lengthy bit streams from the product into short four-digit hexadecimal "signatures." These the technician compares with the correct signatures noted on the system's circuit diagram. If a bit stream is faulty, he traces it back through gates and memory elements until he can isolate an element with correct inputs but faulty outputs. The method has a 99.998% certainty of spotting a faulty bit stream, regardless of its length or the subtlety of its faults.

Signature analysis is more than a new measurement technique. It is a wholly new service philosophy, for the decision whether to adopt it requires a thorough evalua-

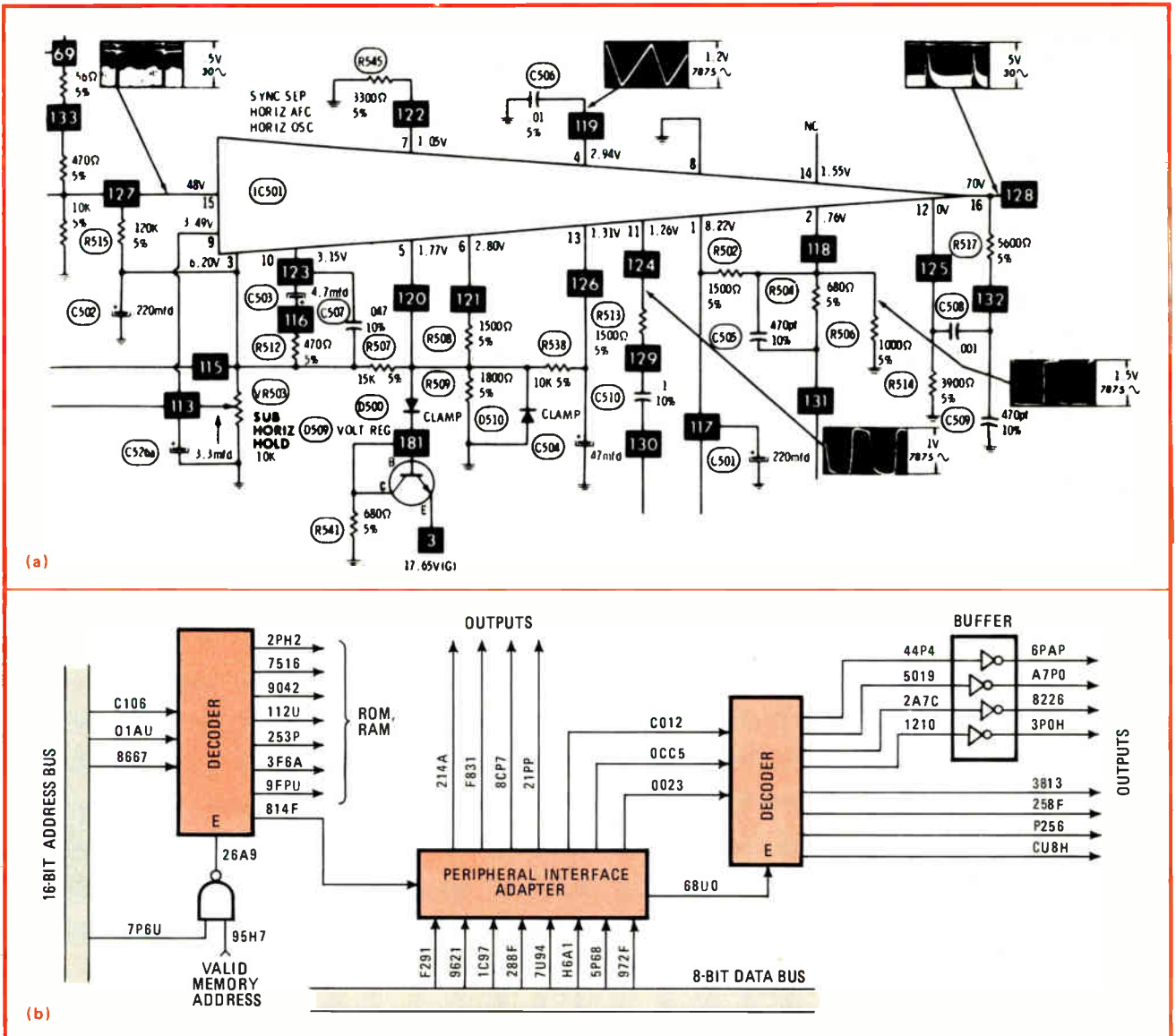

**1. A new form of digital ID.** Diagrams of analog circuits, as for a television set (a), have voltage levels and waveforms noted on them to aid service technicians (circuit is taken from a Howard W. Sams Photofacts service manual). But in digital circuits, all waveforms look alike, and the schematic shown here (b) is annotated instead with hexadecimal signatures that characterize the bit streams unique to each circuit node. A new test instrument derives actual signatures for the technician to compare with the correct ones on the schematic.

tion of its applicability while a product is still in the development stage.

The final decision will usually be based on economics. On the plus side, the technique:

- Increases a product's value to the customer by lowering his cost of ownership.
- Lowers warranty costs for the manufacturer.
- Lowers production-line troubleshooting costs, because it simplifies the job of isolating the speed-related failures, which cannot be caught by present board testers.
- Lowers materials costs, because the product no longer needs to be divided into replaceable modules.

On the minus side, designing signature analysis into a system does add back some other material expenses and also lengthens development time.

On balance, though, the pluses outweighed the minuses in Hewlett-Packard's first applications of the

technique to two digital voltmeters. As will be described later, development time and costs rose roughly 1%. But the return on this investment was substantial. Factory costs dropped, since the 1% or so increase in parts cost caused by adding jumpers and extra read-only-memory space was more than offset by the roughly 5% decrease in other materials costs. As a matter of fact, HP has opted for signature analysis for the majority of its upcoming microprocessor-based instruments and other data products.

### Analog roots

Signature analysis reverts to the advantages of analog-equipment servicing. There, too, the serviceman uses an annotated schematic (Fig. 1a), which clearly shows voltages and waveforms and allows him to make repairs without a detailed understanding of the circuits. By



## How accurate is signature analysis?

For any technique intended to pick up errors in bit streams, it is important to have a measure of the accuracy with which it performs that function. To calculate the accuracy of signature analysis, the first step is to define an error bit stream as a hypothetical sequence related to an erroneous data bit stream in the following way: in the error bit stream, the bit or bits that are in error in the data stream show up as 1s, while bits not in error—regardless of whether they are 1s or 0s in the data stream—show up as 0s. Then, in, say, a 500-bit data sequence, if bit 42 is in error—whether it is a 1 or a 0—bit 42 of the corresponding error bit stream will be a 1 and all 499 other bits will be 0s.

The second step is to invoke the principle of superposition, which is applicable because the feedback shift register is linear. This states that the response of the register to the sum of two inputs is the same as the sum of its responses to the individual inputs. (Note that superposition is used only for this analysis and is not used in the actual instrument.)

From this it follows that if the register input is considered to be the sum (modulo 2) of two sequences—a data bit stream and an error bit stream—then the signature it should display will be equivalent to the sum (modulo 2) of the individual signatures.

Consider this case of summing the two signatures. If there are one or more errors in the data bit stream, the error bit stream will contain 1s in those locations. Then, the sum of their signatures should be different from the signature of the data bit stream itself. It follows that the signature of the error bit stream must be anything but 0 for errors to be detected. This deduction then leads us to examine the conditions under which the signature of the error bit stream becomes 0—the case where errors would go undetected.

With a 16-bit shift register the error bit stream's signature is never 0 for streams of 16 bits or less that contain a 1. This happens because the first 1 to enter the register never has time to leave it before the signature is complete and can never be canceled by a fed-back bit. Thus all errors are caught.

For length 17, one error-bit-stream sequence will be missed; that which starts with a 1, and then has a 1 present at each bit-time where the first 1 is fed back, thus canceling each subsequent error bit. Then, as the 17th bit enters the register, the first and only remaining error bit exits from the register. Thus the signature will be 0 even though there were 1s in the original error bit stream. This means that with 17-bit-sequence inputs, one of the  $2^{17}$  possible combinations may be in error and will not be caught. For length 18, three are missed; for length 19, seven are missed; and so on.

In general, the percentage probability of catching an error in a sequence length  $m$  with register length  $n$  is:

$$100 - 100[H(m-n)] \left[ \frac{(2^{m-n} - 1)}{(2^m - 1)} \right]$$

where  $H$  is the step function (required to make the function zero for sequences of  $n$  or less).

In more useful terms, with register length  $n$  equal to 16, the error is always less than  $1$  in  $2^{16}$ , regardless of  $m$ , the length of the input stream (as  $m$  gets very large, the error term approaches  $2^{-n}$ ). This gives rise to the certainty of 99.998% that an error, if present, can be spotted.

For transition counting, the corresponding probability

that it will detect an error in a sequence of length  $m$  is expressed by the equation:

$$P(\%) = 100 - \left[ \frac{100}{2^m(2^m - 1)} \right] \sum_{r=0}^m \left[ \frac{m!}{(m-r)!r!} \right] \left[ \frac{m!}{(m-r)!} - 1 \right]$$

where  $r$  is the dummy variable. This function increases with increasing  $m$  (see graph).

Although these two equations are valid when errors affect the entire bit sequence, that situation is seldom encountered, even in board testers with algorithmic stimulus generators. More typically, digital errors are subtle and affect only a few bits. This is especially true when one is looking for faulty bit streams some number of gates away from the source of a fault, as happens in the course of backtracing.

Thus an equally meaningful figure of merit for signatures is their ability to catch the most subtle of all faults—the single bit error. Signature analysis really excels here, catching every such error. Transition counting, in comparison, misses  $(m-1)/2m$  of the errors, nearly 50% for lengthy sequences. Logarithmic graph paper, in fact, is required in the figure to show the formidable superiority of signature analysis.

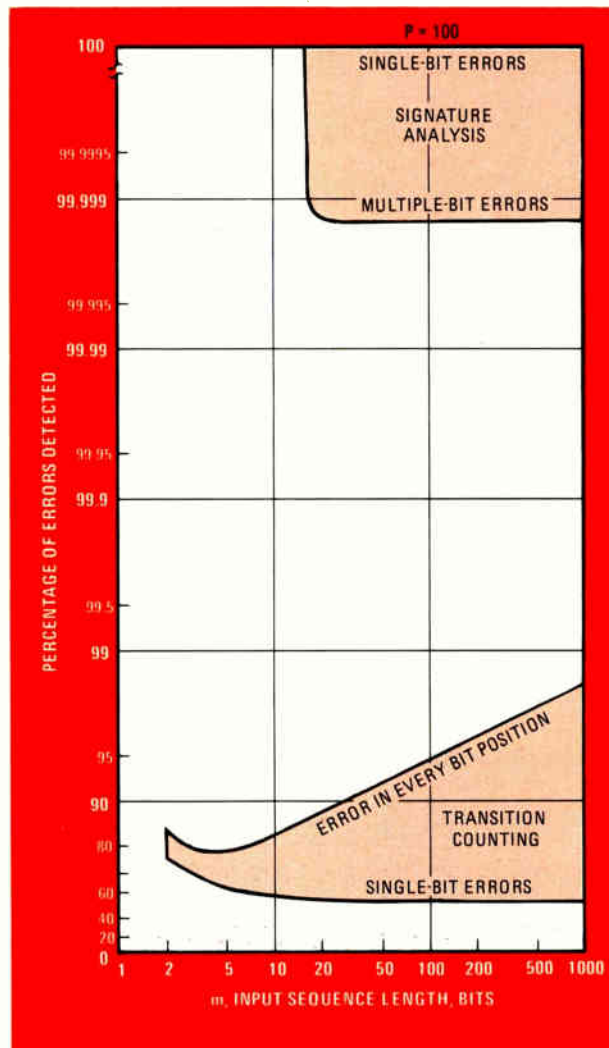

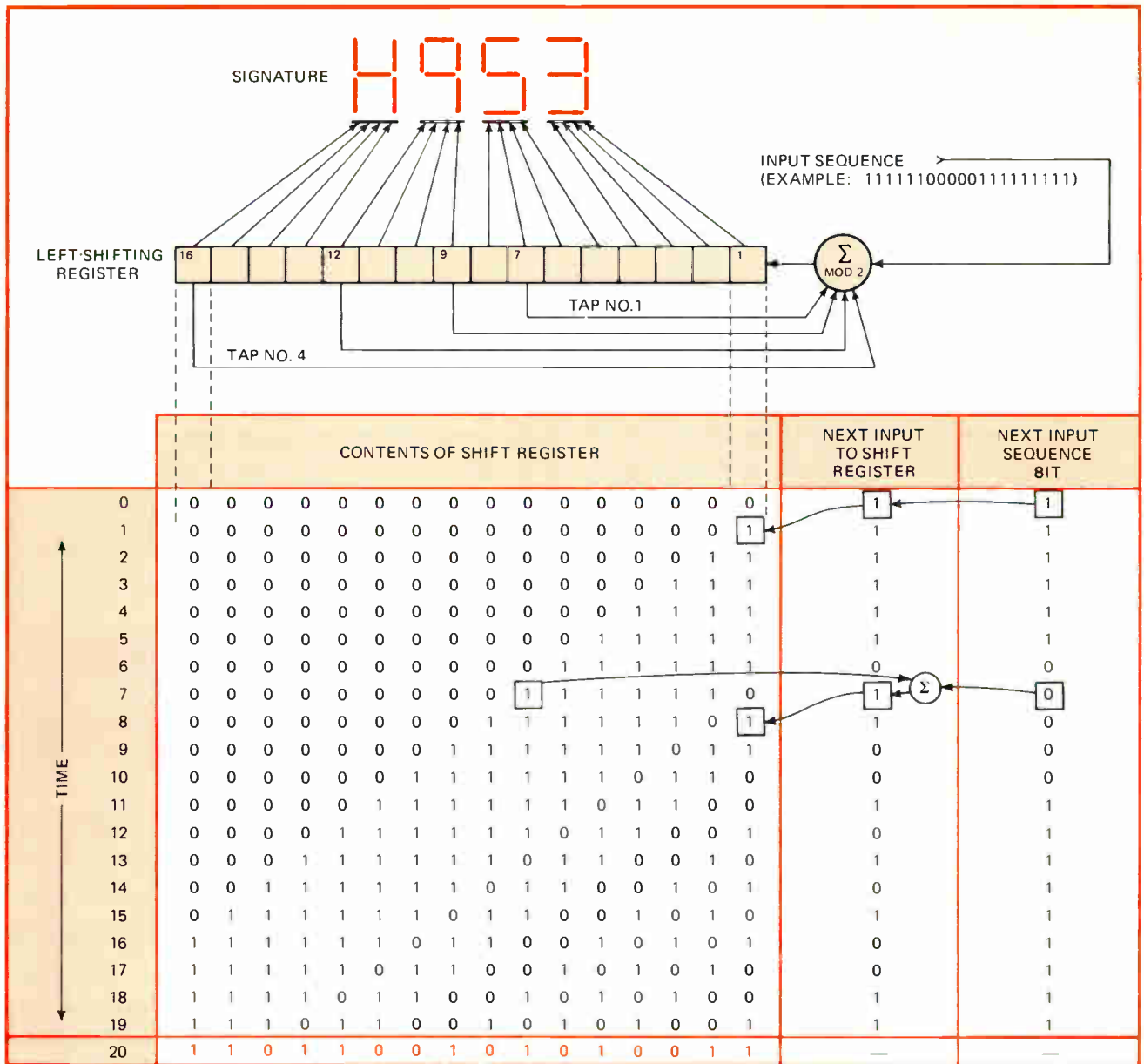

**2. Shifting.** The basic component in the signature analyzer is a linear shift register with feedback. This converts the bit stream from a particular circuit node into a four-digit hexadecimal signature. The table shows how a 20-bit input sequence is processed.

comparing actual voltmeter readings and oscilloscope traces to those displayed on the schematic, he determines the point at which circuit operation becomes faulty and from there traces the problem back to a failed component in the unit.

But in the programmed digital world, service schematics are devoid of waveform, voltage, and other service information, for the not very comforting reason that all bit streams look pretty much alike on an oscilloscope. The problem is compounded with microprocessors, state machines, and controllers, for a more subtle reason: with them there is no longer a one-to-one association between product features and particular sections of hardware. For example, if a keyboard-debouncing function fails in an older random-logic product, a service manual might advise checking the integrated circuits that control that function. With micro-

processors, on the other hand, key debouncing is more likely a time-shared function tying up the whole processor for a brief moment. When it fails, any one of a large number of ICs could be faulty.

### The price of board exchange

As a solution, subdividing the circuitry into replaceable modules has worked reasonably well till now. For one thing, board exchange places relatively few demands on the technical abilities of the serviceman. For another, it is and will remain the fastest way to make repairs when down time is costly, as in large computers and process-control systems. A further advantage is the economy of scale inherent in centralizing repair at the manufacturing site.

But these advantages carry a price. The economy of scale is offset by substantial administrative and inven-

tory costs. A manufacturer may have up to 5% of his assets tied up in service-module inventory, which includes both replacement-board kits and "float" boards in round trip to the factory or waiting in bins. Administrative and handling costs for such a program can also be quite high, particularly as a product approaches obsolescence in the marketplace.

Also, the problem looms of faulty boards in the loop. "Soft" or system-related failures are difficult to detect at repair centers, some of which have reported "no problem found" on 50% of certain returned boards.

Finally, board-level repair is particularly unattractive for supporting products overseas. Turnaround times for modules stretch way out, and import duties of several times the price of the module are often encountered.

For these reasons, centralized board-exchange programs are being widely reevaluated. A partial answer is to move service closer to the customer. For very high-volume products, where board exchange and automated test remain popular, many companies are moving their repair to outlying depots. For lower-volume products where up time is again critical, signature analysis is viable for depot repair of exchanged boards.

Signature analysis was primarily conceived, however, as a more radical change in service strategy. It is a way to substantially reduce repair costs on microprocessor-based products and ROM-based controllers that can stand a few extra hours of down time. Most instruments, computer peripherals, point-of-sale terminals, desk-top calculators, video games, and future citizens' band and television applications fall into this category. The list also includes equipment for which backups are often available: controllers, communications or military equipment, and some of the newer digital products as diverse as taxi-meter and gas-pump controls.

Here the administrative simplicity and cost savings of signature analysis are quite compelling. Troubleshooting by this method requires only a universal \$1,000 test instrument, the HP 5004A signature analyzer (see p. 95), and the service manual of the product, which of course must have been specially designed to contain the necessary modest self-test program.

### Deriving the signature

Everything depends on the signature. A kind of compressed "fingerprint" of the data present on a node, it is compared with the correct signature printed on the schematic of the product (Fig. 1b) so that any discrepancy may be noted and traced to the source. Clearly, the major figure of merit for any such signature must be the accuracy with which it allows faulty bit streams to be spotted.

HP realized some years ago the potential of the signature-tracing method and investigated numerous ways in which bit streams could be compressed or mapped into signatures. Possibilities are transition counts, 1s counts to generate check sums, and even entropy, the communications measure of information. But a linear-feedback shift register, the method eventually chosen, does a superior job in this regard (see "How accurate is signature analysis?" p. 91).

Linear-feedback shift registers have been used as

generators of pseudorandom binary sequences in cryptography, mechanical-vibration control, communications channel testing, and digital radar. But for signature analysis, the register is configured as shown in Fig. 2. Bit sequences being measured are summed in modulo 2 with the register feedback. The register is clocked by the same clock as the bit stream under measurement. Input sequences may be any length, but at the end of the measurement only the residue remaining in the register is looked at. These 16 bits, when displayed in a hexadecimal format, comprise the "signature" of the measured bit stream. A nonstandard hexadecimal character set (0123456789ACFHPU) was chosen for easy readability and compatibility with 7-segment displays.

The table in Fig. 2 shows how the register generates a signature from the 20-bit sequence 1111100000-11111111. Initially (time 0 thru 7) the register acts merely as a shift register. At time 7, the first 1 of the input sequence has reached the first feedback tap (tap 1, Fig. 2). It is fed back and mixed with the input 0, with the result that a 1, not a 0, is next clocked into the register (time 8). This behavior continues until the end of the measurement when a residue of 16 bits, 1101100101010011 (time 20), is all that is left from the 20-bit input sequence. (Note the total dissimilarity in appearance between this residue and the original 111110000011111111 input sequence.) This residue is displayed in hexadecimal format as H953, the signature of the 20-bit sequence.

### Designing in signature analysis

In an actual circuit designed to incorporate signature analysis, the bit sequences may be any length, probably much longer than 20 bits. A portion of the circuit's read-only memory—perhaps 5%—contains a special program for stimulating the various nodes in the circuit (Fig. 3). The stimulation serves more to "wobble" or force a state change on the nodes than to generate meaningful data. Frequently this stimulus program may be merged with the product's performance-verification program. The correct signatures are developed by simply exercising the various parts of a circuit that is known to be good and noting the results on the circuit diagram.

A second requirement, beyond stimulating nodes, is to break feedback paths within the circuit either by using hardware switches, jumpers, or connectors, or by disabling gates with software. This requirement is necessary to prevent a fault from being fed back around and perturbing all data nodes. In practice, adding the ability to break feedback paths incurs an incremental hardware expense of less than 1%. (The cost is more than offset, however, by the savings resulting from no longer needing to subdivide the product into small, replaceable modules.) When these two requirements are met, back-tracing a fault to its source is a straightforward process of tracing faulty signatures.

In using signature analysis, the procedure varies slightly depending on whether the fault lies in the kernel (the minimum configuration of microprocessor and ROM necessary to run the simplest test program) or in the outlying circuitry.

If the fault is in the outlying circuitry (a keyboard or

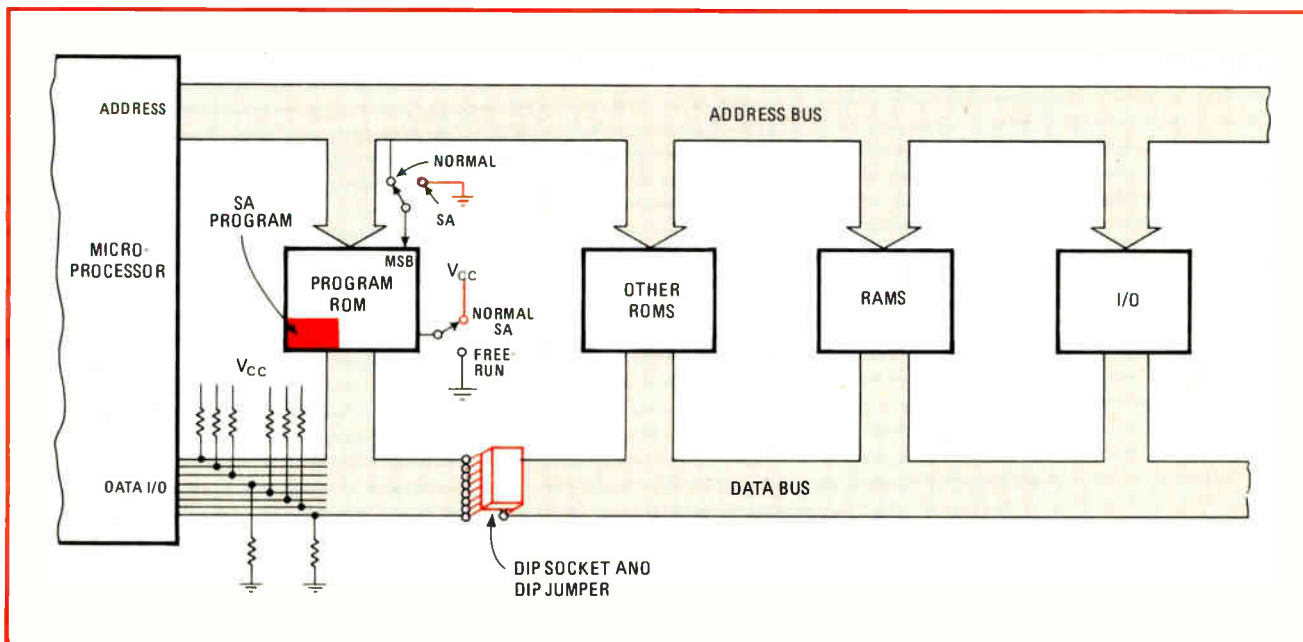

**3. Adapting the product.** To incorporate signature analysis in a microprocessor-based product, the designer has to add extra program steps to the read-only memory, some switches to put the system into the signature-analysis mode, resistors to force a no-operation instruction when the ROM is disabled, and jumpers that can be removed to isolate portions of the circuit. Here, a 16-pin jumper in a dual in-line package (type AMP 435704-8 or equivalent) is inserted in the data bus.

display scanner, input/output latch, etc.), the field engineer simply switches the circuit to the diagnostic mode. Then, guided by a troubleshooting tree, he uses the test instrument to trace faults back to their source.

But what if the problem lies in the kernel, and even the ROM stimulus program will not run? Here, the microprocessor itself can provide a stimulus if its address counter is allowed to sequence through the address field. To do this it is only necessary to open the data/instruction bus and force the no-operation instruction onto it. This stimulus program checks out all the address lines and the individually enabled ROMs as well. All of these nodes are readily characterized with signatures.

Since signature analysis relies on the ability of a system to control itself in a synchronous manner, asynchronous circuits, like monostables, direct-memory access, dynamic memory, or interrupts, need to be carefully controlled. Generally, simple provisions in the hardware can be made to force them into a synchronous or disabled condition when that is required for a particular test.

### The technique in use

As an example, consider the first HP instrument to use signature analysis—the 3455A system voltmeter from the HP Loveland Instrument division in Colorado. The digital portion is quite extensive. It is microprocessor-controlled and contains a self-test program stored in ROM. If the self-test fails, a jumper inside the enclosure is removed, breaking feedback loops and also enabling the signature-analysis routine which is used now to diagnose the instrument.

The decision to go with signature analysis influenced the design in several ways, all of which make it easier to troubleshoot down to the component level. The whole

digital portion is on one board. The elimination of connectors and a multitude of smaller pc subassemblies reduced the production cost and also made all the parts easily accessible for testing without the use of special extender boards.

Naturally, some extra design time, a few more ROM locations, and the extra jumper wire were the price paid for this kind of serviceability. The cost evaluation proved to be interesting: the production cost actually fell, and the extra design time amounted to approximately 1% of the overall development time.

### Manual aid

Besides the design engineer, the writer of the service manual made an important contribution to the successful application of the signature analysis to the 3455A voltmeter. After learning the internal algorithms of the product almost as well as the designer and having no precedent to fall back upon, he developed a number of innovative ideas for the service approach that were enthusiastically received by the field engineers.

The service manual is written in such a way that a person unfamiliar with the signature analyzer can walk up to a sick voltmeter, read the instructions, and within a short time locate the fault. One element in the manual is a troubleshooting flowchart or tree (Fig. 4), which systematically guides the technician through the fault-finding process.

The initial tests may rely very little on signature analysis, yet may allow isolation of the fault down to a specific area. Diagnostic programs cannot carry on from here, since they do not have access to individual nodes, but it is from here on down to the components that signature analysis excels.

At this level, the repairman uses the annotated sche-

## The signature analyzer

The 5004A signature analyzer checks out a compatibly designed digital product by detecting the bit streams at various circuit nodes and displaying them as hexadecimal signatures, which may or may not agree with the correct values noted on the schematic. It is a lightweight, portable instrument, built around the feedback-shift-register circuitry that produces the signatures, and it is equipped with an active probe for data input.

The probe has dual threshold levels that are compatible with transistor-transistor logic. It also serves as a TTL probe, rather like the HP 545A, and in this capacity provides additional troubleshooting information by indicating high, low, bad-level, and pulsing states.

Through an active "pod" on the 5004A's input cable, the product under test supplies the instrument with three gating signals: start, stop, and clock. Start signals the beginning of a measurement window, preparing the shift register to receive information from the data probe. Stop closes the measurement window. Clock is the system clock of the product under test and assures synchronous acceptance of data and gating signals by the shift register. The active edge of each of these gating signals can be selected at the front panel, giving the designer more latitude in applying signature analysis to his product without adding hardware.

The front panel also includes a gate light and an unstable-signature light. The gate light indicates proper start/stop gating operation, remaining on during the measurement window, with stretching to make it visible to the operator during very short on times. The unstable-signature light indicates a difference between signatures in adjacent windows, alerting the user to intermittent faults that may not be apparent from the display.

Two useful controls are the hold and reset switches. The hold feature allows observation of single-event (one-shot) signatures, such as a power-on-restart routine. The instrument will display only the signature associated with the first valid window and will hold the display until the probe reset switch is pressed. The hold/reset controls are also useful for taking signatures in awkward locations where it is impossible to simultaneously probe and watch the display.

Since the 5004A is synchronized to the system clock of the product under test (up to 10 megahertz), setup times become important. Setup time is the period during which

data must be stable before arrival of the selected clock edge. In the 5004A, the maximum data setup time is 15 nanoseconds (but typically 8 ns). This leaves the balance of the clock cycle for the settling times of components in the product under test. No hold time is required after the selected clock edge.

Any data state changes between clock edges are disregarded. The first data bit accepted during a measurement window is the one coinciding with the synchronized start-signal edge. The last bit accepted is that preceding the synchronized stop-signal edge (see figure).

Tri-state bus architectures are common in many types of equipment and pose the problem of how to interpret the floating state for the purposes of consistent signature detection. Pullup resistors in the circuit under test would force a bus high in the third state, but would slow down the state transitions and possibly cause inconsistent signatures. Instead, the 5004A data probe pulls to the 1.4-volt level, through a 50-kilohm input resistor, and employs hysteresis. This causes the floating state of a tri-state bus to be entered without ambiguity into the signature as the same state (0 or 1) as the most recent valid bit.

To increase the confidence of on-site service, the front panel self-test feature allows a go/no-go checkout of the entire 5004A, including probe, pod, and cables. An internal program exercises the analyzer and displays the result. If this display indicates a malfunction, the 5004A itself can be switched to its own test mode and diagnosed to the component level with another signature analyzer.

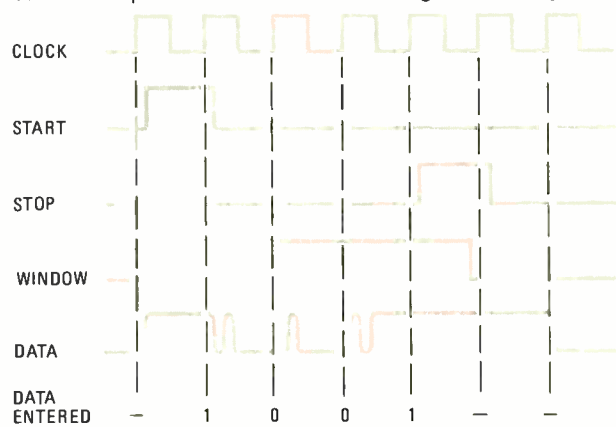

matics and graphs of board layouts, together with the flow chart, to find the bad node. In some cases, the manual includes instructions as to which IC to replace. In other cases the use of a logic probe, which is an integral part of the logic tracer, may be required. A current sensor, such as the HP 547A, helps to find short circuits between traces or to ground and is particularly helpful when bus problems are encountered.

In the case of the voltmeter, the first test checks its kernel, which consists of the microprocessor, the clock circuit, the power supply, and a number of external gates. After the proper functioning of the kernel has been verified, the test setup is changed (one control wire of the logic tracer is moved to another pin in the 3455A), and the remaining portions of the circuit are tested. A special portion of the ROM control loads and reads the

random-access memories. Some asynchronous portions require a third test setup. Again, the connection of the start wire is simply moved to the next pin designated for this purpose, and troubleshooting can continue.

Several methods of documentation have been tried successfully. The 3455A service manual shows pictures of the board and defines the setup for each test (Fig. 4). Each picture shows only the signatures related to the particular test, directing the field engineer's effort towards the important areas on the board. The ROM program even simulates interrupt signals, ensuring, however, that they occur predictably at the same spot within a window so that stable signatures result.

The signature analyzer has its own self-check. Each test setup is tested by touching the power-supply voltage with the instrument's probe to input a sequence of all 1s.

**NOTE 1**

The LOGIC TRACE controls should be set as follows for this test:

*LINE* ..... ON (IN)  
*START* ..... \ (IN)  
*STOP* ..... / (OUT)  
*CLOCK* ..... / (OUT)  
*HOID* ..... OFF (OUT)  
*SELF TEST* ..... OFF (OUT)

Pin	Signature	Pin	Signature
U17 1	1P03	U26 2	CP65*
2	7F46	3	8AH5
3	40CF	5	0952
4	HC7A		
5	7F46	U32 1	F080
6	77H9	2	U491
8	2A3P	3	88H7
9	1018	4	U491
10	7F46	5	C94U
11	A725	6	0589
12	390F	8	F509
13	7F46	9	C94U
		10	3613
U18 1	CH2H	11	8AH5
2	7F46	12	3613
3	6P52	13	F080
4	CF66		
5	0000	U39 10	7F46
6	6P03	11	0589
8	6725	12	C94U
9	91PF	13	F080
11	0A1A		
12	2952		
U19 2	CH2H		
3	CHC4*		
4	6C0P*		
5	2952		
6	A43P*		
7	91PF		
9	88H7		
10	390F		
11	129C*		
U20 2	1018		
3	0C93*		
4	CP65*		
5	HC7A		
6	F517*		
7	1P03		
9	88H7		
10	28PH		
11	6P03*		

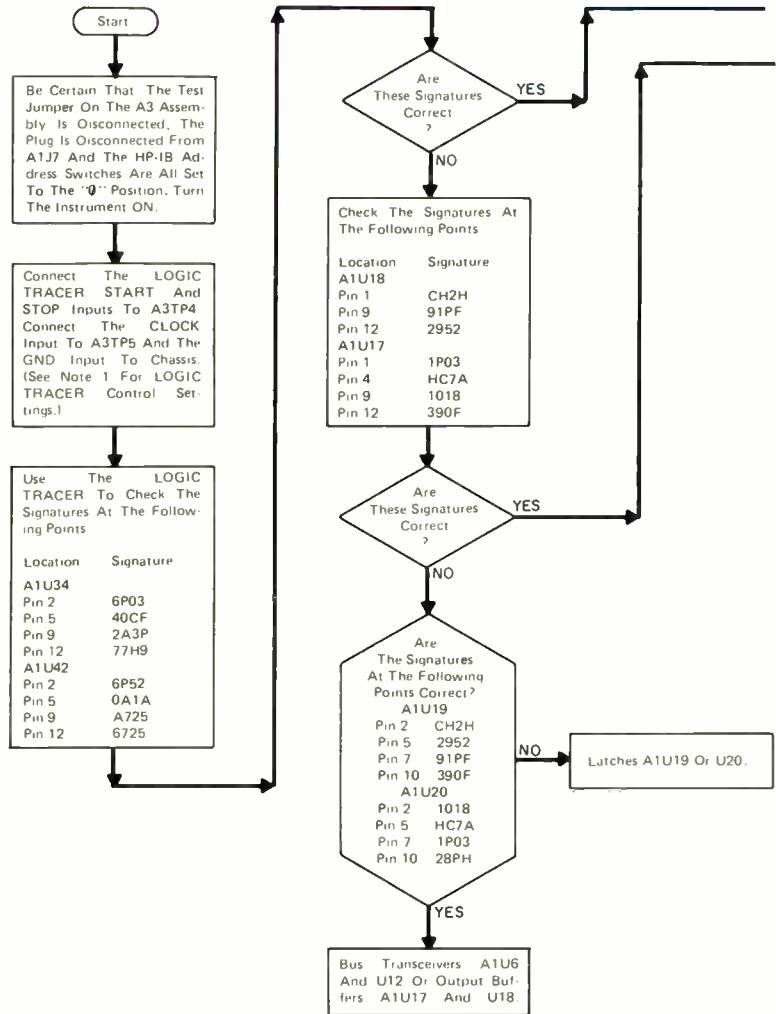

**4. Troubleshooting tree.** The service manual for the HP 3455A digital voltmeter, the first instrument to use signature analysis, contains a troubleshooting tree and a list of signatures that should be found at the designated pin numbers of the various devices.

If this characteristic signature is correct, the setup conditions and the framing of the measurement window are verified. Specifically, this tells the user that the switches on the signature analyzer, as well as all the jumpers, switches, and control buttons in front and rear of the voltmeter are correctly set. Thus, the confidence level of the user is very high at the start of a test.

This application of signature analysis went particularly smoothly, because the engineer developing service techniques worked closely with the design engineer. Generally, the design engineer wrote the stimulus routines while the service engineer involved himself with documentation and overall test strategy. This early involvement also ensured that the designer, with the many demands on his time, did not neglect to think about serviceability and, for example, put off allocating read-only-memory space till inconveniently late in the design cycle.

The fact that signature analysis is built into the 3455A voltmeter also made final testing on the production line

much easier. A signature analyzer is now a favorite piece of production-line test equipment for the 3455A.

Thus, the signature analyzer promises to have a significant impact on present service costs. With the industry presently spending roughly a billion dollars annually to find the 10 million ICs that fail each year in the field, such a technique is needed. Although IC pre-testing and burn-in programs have gone a long way toward weeding out weak devices, changes are nevertheless needed in service strategy as well. The signature analyzer offers a new option for those who are planning service strategies. □

**Closing the loop**

*Pending HP's completion of an applications note on how to build signature analysis into new equipment, Gary Gordon and Hans Nadig will be happy to answer readers' questions on their article directly by telephone. They can be reached at Hewlett-Packard's Santa Clara, Calif., division plant at (408) 246-4300 between 9 and 5, Pacific Standard Time.*

# Thin-film magnetic heads excel in packing and moving data

New approach should spawn computer disk and tape drives with larger storage capacities and higher rates of data transfer

by Thomas A. Roscamp and Paul D. Frank, *Applied Magnetics Corp., Goleta, Calif.*

□ Magnetic read/write heads with sensors of thin-film materials have left the laboratory and are entering the commercial realm. They bring with them the promise of a new generation of computer disk and tape drives with larger storage capacities at lower costs per bit and higher rates of data transfer.

The steady improvements in tape and disk drives have been primarily the result of incremental advances in recording media, reduced head-to-media spacing, and increased head and system reliability. However, thin-film technology represents a breakthrough in head design. A thin-film head being produced by Applied

Magnetics Corp. is a combination of vacuum-deposited sensors and traditional housings packaged into a complete recording head (Fig. 1). It offers designers of disk and tape drives at least five significant advantages:

- Improved frequency response because the sensors are made with laminated layers of magnetically oriented films that better couple flux between coil and gap.
- Higher bit-packing density because of the improved characteristics of the head's magnetic field.
- Higher track density with more cost-effective, precise track definition.
- Increased reliability and longer head life because of an

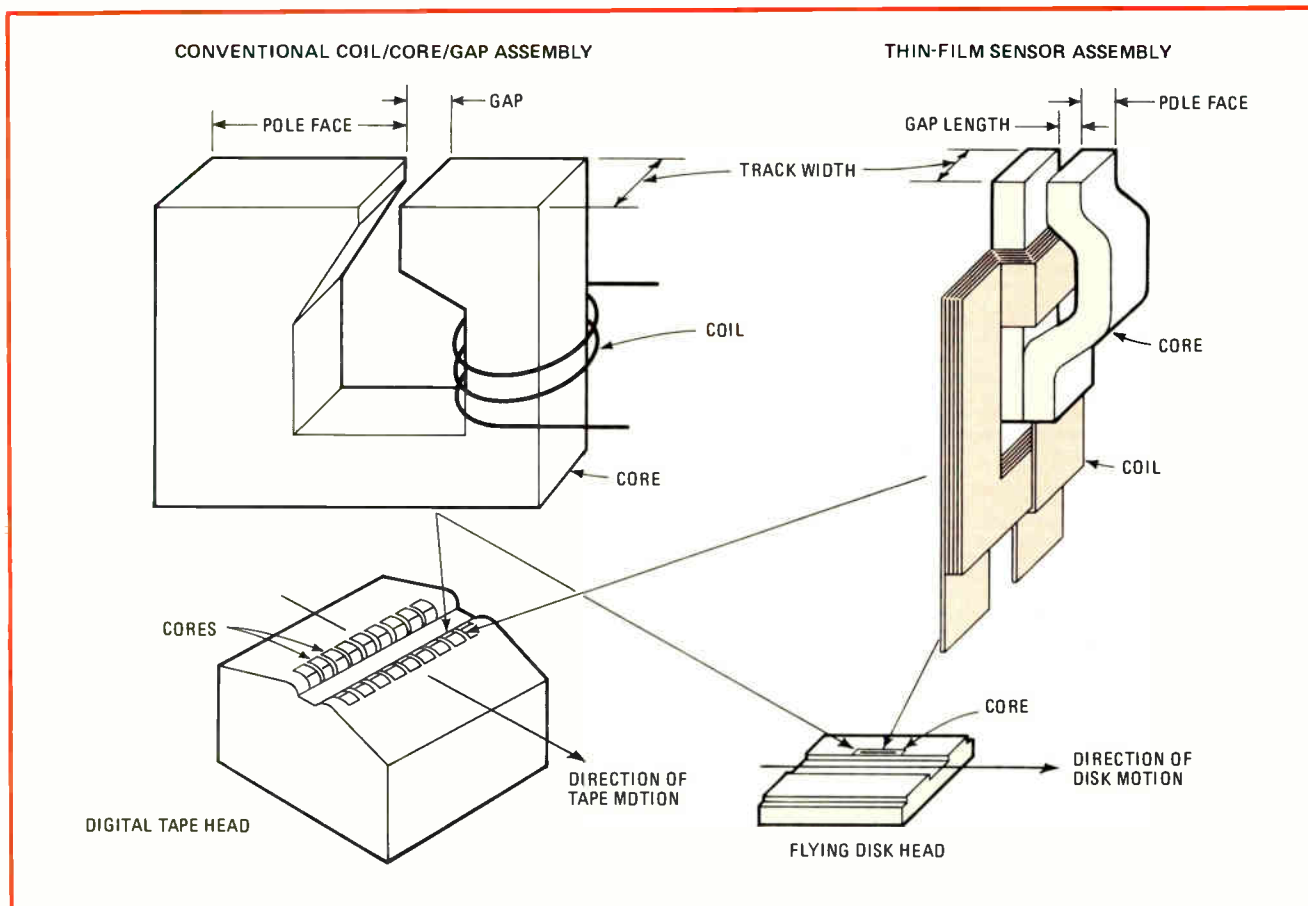

**1. Head to head.** The thin-film sensor used in magnetic recording heads is produced by vapor deposition as a single structure, giving greater control over its characteristics, while the conventional head is produced from separate parts. (The assemblies are not drawn to scale.)

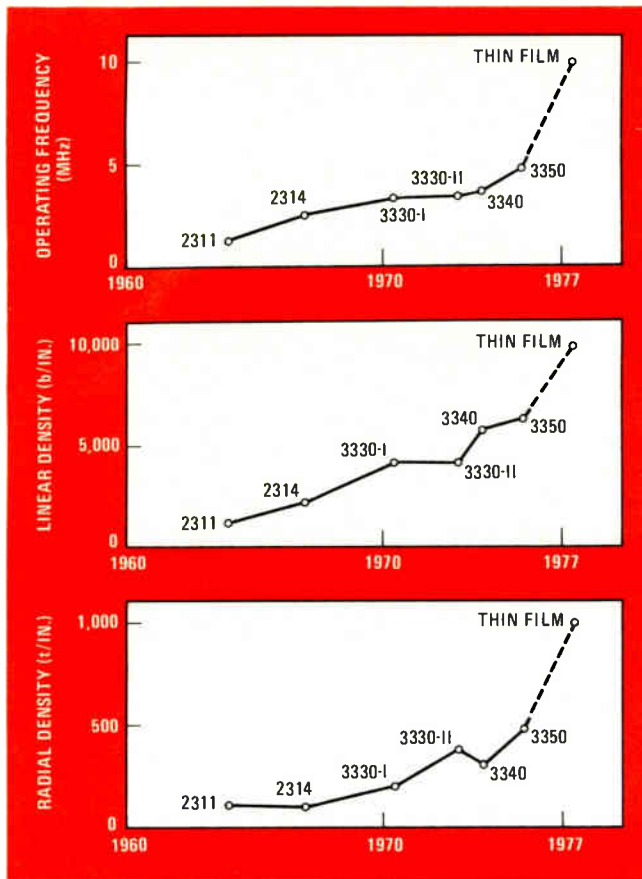

**2. Step upward.** The thin-film magnetic head will significantly improve operating frequency, linear bit density, and radial track density. These curves trace the improvements over the past several years for various IBM-compatible moving-arm disk drives.

integrated structure, better uniformity in manufacturing processes, and new materials.

■ Cost advantages in volume production because of automated fabrication.

This year disk drives with single-track thin-film heads moving on low-mass sliders will achieve bit-packing densities of 10,000 bits per inch and track densities of 1,000 tracks/in. Figure 2 shows how such performance fits into the development history of IBM-compatible actuated disk heads.

For disk drives with multiple-track fixed heads, thin-film technology permits increasing the number of tracks per head to achieve twice as much data storage with the same number of heads (or the same amount with half as many heads). The combined improvements in bit and track densities mean that total data storage in fixed-head disk drives can be three or four times greater than the data storage possible in machines with conventional heads.

### Performance up, costs down

For digital tape heads, thin-film techniques offer marked performance improvements and lower system costs in high-performance nine-track heads of the dual-gap read/write design used widely in the computer industry. All nine sensors can be produced simultaneously by vacuum deposition. Closer dimensional toler-

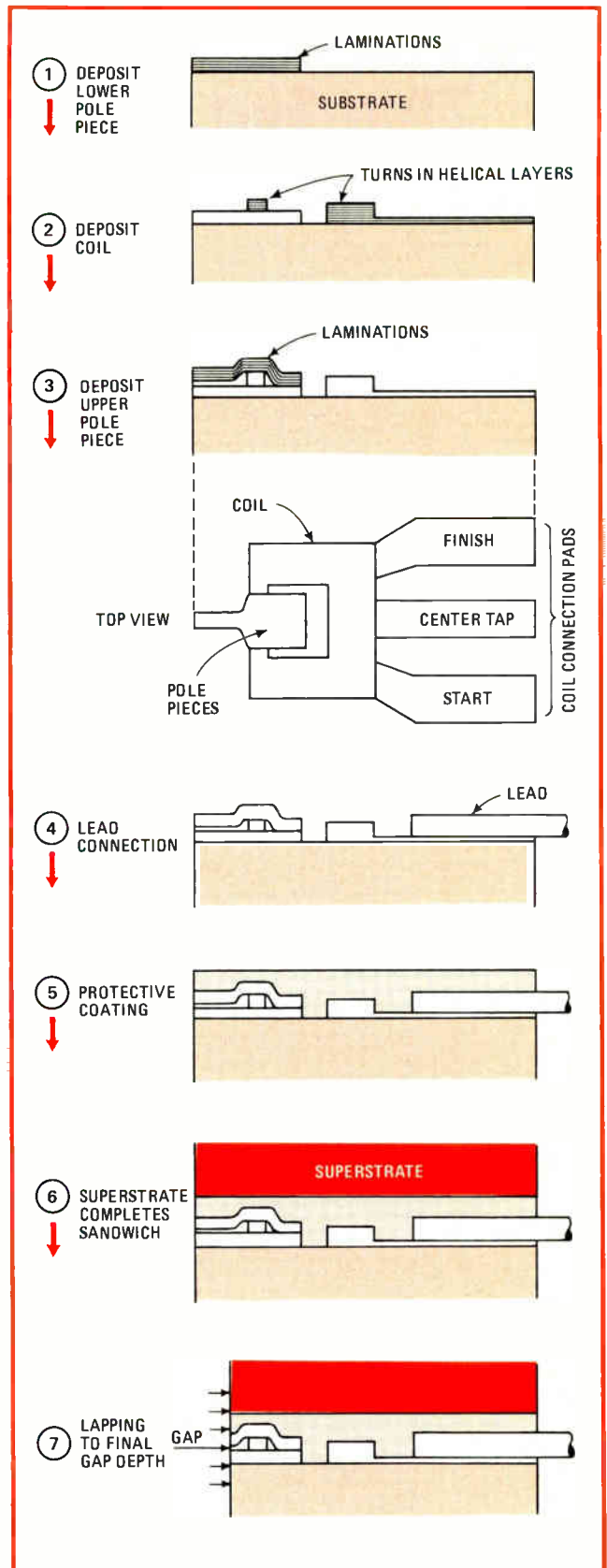

**3. Sequence.** The production of a thin-film sensor begins with the vacuum deposition of the laminated lower pole piece and proceeds through depositions of the coil, and upper pole piece. The leads, protective coating, and superstrate are then added.



ances can be achieved, and there is reduced crosstalk and less need for magnetic shielding.

Moreover, a new generation of 18-track read/write heads designed for standard 1/2-in. computer tape with 10,000 b/in. on each track is feasible. Together with higher track densities, the improved bit-packing densities will make possible as much as three times more data storage than existing tape drives, at a lower cost per byte for the user.

Thin-film technology also looks promising for instrumentation recorder heads that will permit higher data rates. The heads also will be useful for video-recording applications where images are recorded linearly at high tape speeds. However, present limitations on gap sizes and the number of turns of the conductor make unlikely any use soon in diskettes, audio tape recorders, and lower-speed video recorders.

### Making thin-film heads

Once a sensor design has been established, hundreds or even thousands of them can be produced simultaneously during a single vacuum deposition. Thin-film head manufacturing may lend itself to further simplifications, such as deposition of the sensor directly on the air-bearing slider of a disk head or construction of hybrid heads where the read/write circuitry is integrated into the total head package.

The steps in the deposition and packaging of a multi-turn thin-film sensor are shown in Fig. 3. The substrate and superstrate may be of a variety of materials, such as special glasses, titanates, ferrites, Fotoceram, or sapphire. Several hundred layers of different materials may be deposited to form the pole piece, coil, and gap required for a particular type of sensor.

In this design, the pole pieces consist of layers of magnetic material with layers of an insulating material deposited between them. The coil consists of multiple turns of a conducting material deposited in a square helical arrangement, also with an insulating layer separating the turns. Figure 4 is a microphotograph of the thin-film sensor as seen through the protective coating. The total thickness of material between substrate and superstrate typically ranges from 0.0005 to 0.003 in.

The design of thin-film heads is considerably more complex than that of their conventional counterparts. The most important design factors in conventional heads are gap length and depth, core material and geometry, and head contour. However, gap length is the primary variable in tailoring the head to an application.

### Computer aids analysis

In thin-film heads, the geometry of the entire pole piece plays as important a role as does gap length. This factor, plus the complex physics of thin-film-head operation, requires a computer-aided design analysis to fit all the variable parameters to system requirements, such as velocity of the medium, packing density and transfer rate of the bits, head-to-media separation (flying height), medium material and thickness, write current, desired playback voltage levels, and characteristics of the read/write electronics.

The table gives a comparison of typical performance

characteristics and ranges of operating conditions for conventional and thin-film recording heads. Also included is a comparison of the measured performance of a standard 3330-11 disk head and a thin-film version of the head operating under the same conditions. The differences in performance can be understood by studying the differences in construction.

In the conventional head design, the pole face must be extremely long compared to other important dimensions such as gap length, head-to-medium separation, and medium thickness. It is so much longer, in fact, that in theoretical calculations it is traditionally considered to be infinite. For the thin-film sensor, the length of the pole face is less than a hundredth of that of the conventional pole face, and it is an important design variable.

Thin-film core materials offer significant improvements in permeability and frequency response, allowing higher transfer rates. These core materials have higher saturation flux densities than do standard ferrites. This factor allows stronger fields to be used during recording and makes feasible the utilization of newer "high-energy" recording media.

The write current levels and playback voltages produced by these multiturn thin-film designs are generally compatible with conventional read/write electronics. Therefore it is possible to extend the performance of storage systems without significant advancements in electronics technology. An example of this is the improved resolution of the 3300-11 thin-film head, shown in the table.

For both conventional and thin-film heads, control over the gap lengths and their tolerances is roughly the same. However, with the thin-film head, such tolerances as gap scatter (the gap-to-gap misalignment in a multi-

TABLE: CONVENTIONAL VS. THIN FILM HEADS

Head characteristic	Typical ranges		3330-11 disk head	
	Conventional	Thin-film	Conventional	Thin-film
Coil turns	10-1,000	10-30	50	20
Gap length, $\mu$ in.	20-250	20-100	100	100
Pole-face length	0.030-0.300 in.	50-500 $\mu$ in.	0.030 in.	220 $\mu$ in.
Track width, in.	0.001-0.050	0.001-0.050	0.002	0.002
Inductance (full coil)	10 $\mu$ H-100 mH	100 nH-1 $\mu$ H	23 $\mu$ H	600 nH
Resonant frequency	100 kHz-10 MHz	50-200 MHz	9 MHz	60 MHz
Cable and read-input capacitance	usually critical	usually not important	15 pF	15 pF
Write current rise time	limited by head	faster: limited by cable and electronics	62 ns	13 ns
Write current (peak-to-peak), mA	10-200	100-400	150	200
Output voltage	100 $\mu$ V-100 mV	100 $\mu$ V-10 mV	2 mV (40 $\mu$ V/turn) @ 4,000 b/in., 5 MHz	1.3 mV (65 $\mu$ V/turn) @ 4,000 b/in., 5 MHz
Resolution	compromised	optimized	50% @ 4,000 b/in., 5 MHz	78% @ 4,000 b/in., 5 MHz
Permeability	less than 1,000 @ 2 MHz	greater than 1,000 @ 20 MHz	500 @ 5 MHz	1,500 @ 5 MHz
Core saturation flux density	limits the core field	higher	3,500 gauss	10,000 gauss
Flying height, $\mu$ in.	20-100	20-100	40	40

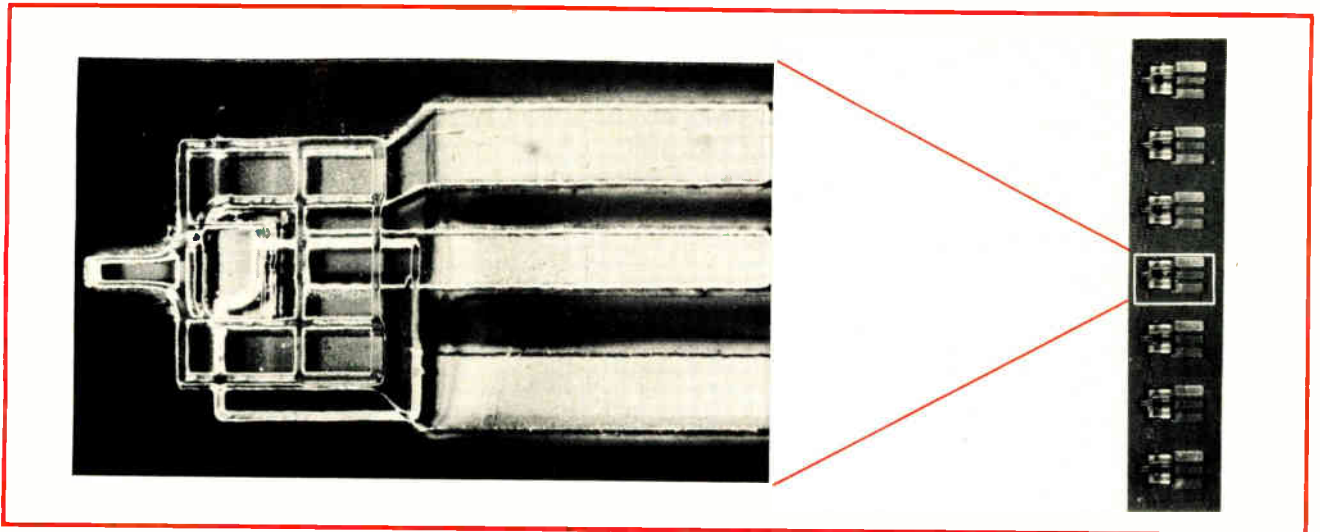

**4. The sensor.** A single thin-film sensor is shown in a microphotograph as viewed through the protective coating. All sensors in the linear array are deposited during a single series of vacuum depositions, allowing more precise track placement and better gap-to-gap alignment.

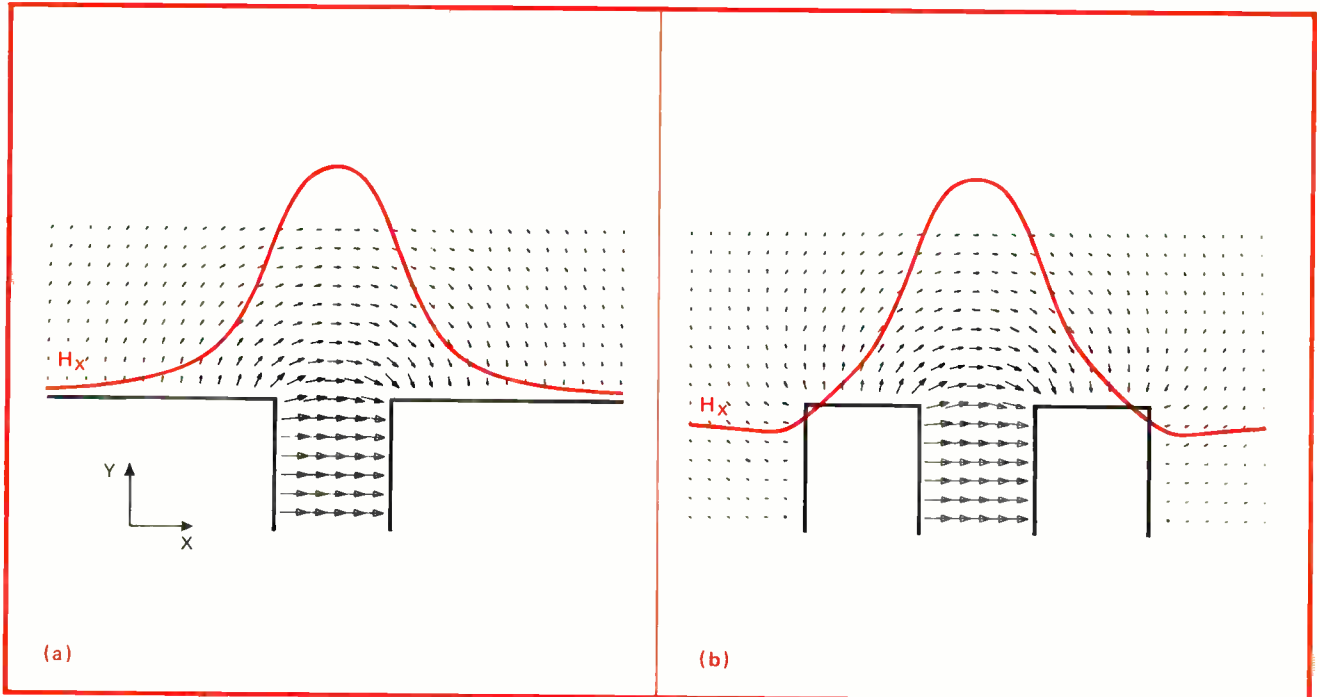

**5. Fringing fields.** The gap fringing fields for conventional (a) and thin-film (b) heads show the thin-film head's field has steeper sides and reaches a negative, minimum value before turning upward. Corresponding negative dips for the conventional head are far from the gap.

channel head) can be better controlled, because all the sensors are deposited simultaneously. The manufacturing technology generally allows better control of track widths and locations than would be economically possible with techniques used to produce conventional heads.

**Pulse shape is the key**

A vector representation of the gap fringing field for a conventional head (Fig. 5a) shows a longitudinal component  $H_x$  in the direction of the medium's motion and a perpendicular component  $H_y$  at right angles to the medium's surface. For most digital recording applications,  $H_x$  is the component of primary interest because

information is recorded longitudinally in the medium.

For a conventional head,  $H_x$  reaches its maximum above the gap center and decreases to either side of the gap, appearing to approach zero asymptotically at large distances. This basic shape of the  $H_x$  "pulse" is the same for any head-to-medium separation.

For the thin-film head (Fig. 5b),  $H_x$  again reaches its maximum above the gap center. However,  $H_x$  decreases more rapidly than in the conventional head, passes through zero, dips to a minimum value near the outer edges of the pole pieces, then asymptotically approaches zero from below.

The location of the negative dips in the thin-film head's field is a result of the small dimensions of the pole

face combined with the requirement from Maxwell's equations that the integral of the  $H_x$  pulse for any recording head must be zero:

$$\int_{-\infty}^{\infty} H_x dx = 0$$

The location of the negative dips close to the gap region means they interact with the gap field to form an  $H_x$  pulse narrower and steeper on the pulse edges than is the case with the conventional head. In the conventional head, the negative dips occur at points that lie far from the gap, so they do not play a significant role in the gap fringing field.

For digital recordings, the playback voltage pulse (Fig. 6) for an individual recorded transition (a bit of recorded information) tends strongly to resemble the shape of the  $H_x$  pulse. As a result, narrowing the  $H_x$  pulse tends to decrease the playback pulse width, thus decreasing crowding of these pulses and allowing higher bit densities to be read. Similarly, the increased steepness of the  $H_x$  pulse edge causes a shorter transition to be written on the medium, which gives less crowding of write pulses and allows higher bit densities to be recorded.

### Setting write current

With conventional digital recording heads, one of the usual compromises in setting the write current is between resolution (or playback voltage) and overwrite of old information. As the write current is increased, the depth of penetration into the medium increases, and the playback voltage tends to increase.

However, as the depth of penetration increases, demagnetizing fields build up in the medium to oppose the transition being written. This phenomenon is often referred to as self-demagnetization. Simultaneously, the steepness of the  $H_x$  pulse of the conventional head decreases with increasing write current, which tends to produce a longer transition (Fig. 7a). This degradation of steepness results in what is commonly called recording demagnetization.

Thus, as the write current is increased, the effects of self-demagnetization and recording demagnetization cause a wider transition to be written, increasing write-pulse crowding at typical recording densities and reducing the playback voltage output. The optimum write current is the point on the curve in Fig. 7b where the tendency for increased playback voltage from improved penetration reaches a maximum before it begins to be reduced by increasing demagnetization effects.

Unfortunately, this current is not high enough to give satisfactory overwrite of old information in most applications, because the resulting depth of penetration is too shallow. This forces operation at a write current considerably higher than this optimum value, which means a sacrifice in resolution.

### Reversing recording demagnetization

For the thin-film head, however, the steepness of the  $H_x$  field continues to increase with higher write current because of the physical requirement imposed by the

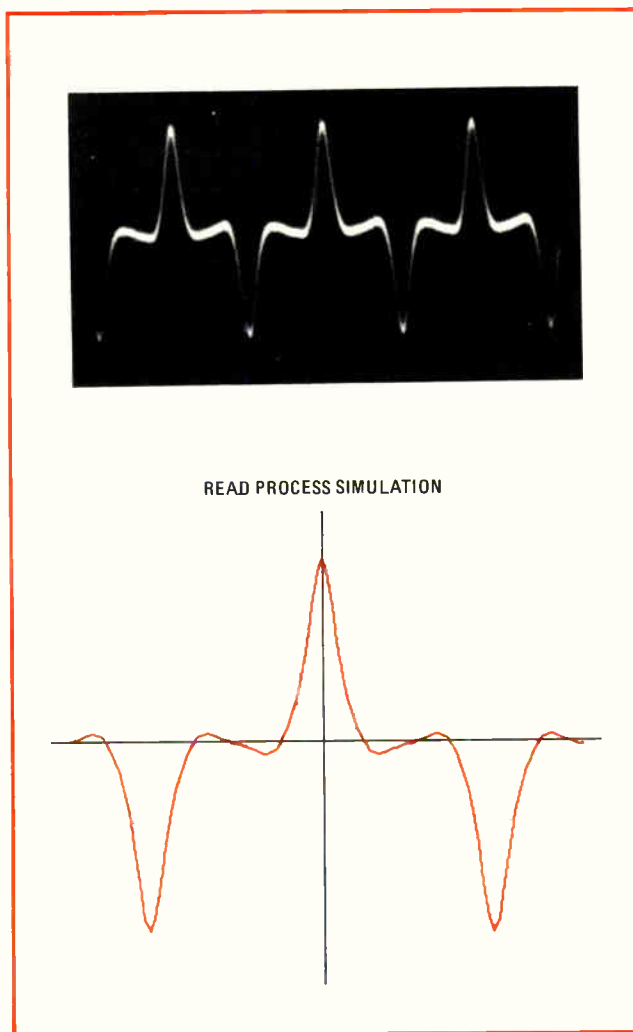

**6. Playback.** The playback voltage pulse for a thin-film head resembles the gap fringing field shape of Fig. 5. The plot shows the results of a computer simulation of the read process that closely models the actual pulse displayed on the oscilloscope.

presence of the negative dips (Fig. 7a). The effects of recording demagnetization are reversed, and written transitions become shorter.

Self-demagnetizing effects still occur, but they are balanced by the improvement in recording demagnetization. The result is a flat saturation curve for the thin-film head (Fig. 7b). This allows operation at a write current where good resolution and good overwrite can be achieved simultaneously.

Thin-film heads avoid the problems associated with the high inductance of conventional heads—although in doing so they develop their own problems that must be solved. High inductance during recording leads to limitations on the write-current rise time, in turn increasing transition width and then write-pulse crowding. During playback, this inductive behavior can also cause resonance problems that limit the number of turns in the coil. These problems also restrict the electronics used for the read process.

The small dimensions of the thin-film pole piece result in inductances typically much less than that for the

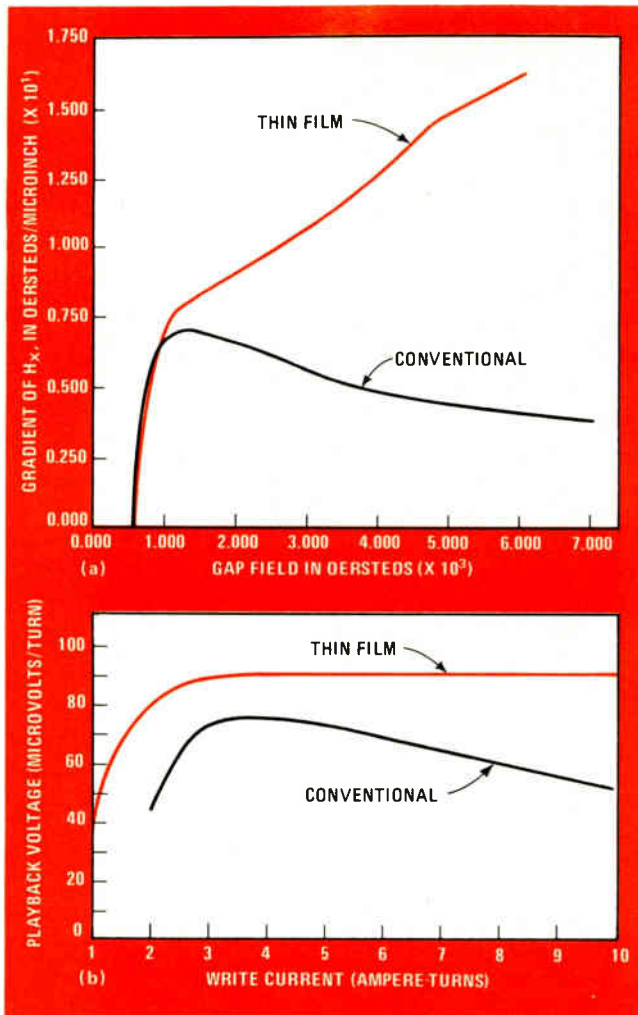

**7. Read and write.** Computer analysis (a) shows the thin-film head's steeper longitudinal component of field for a head-medium separation of 40  $\mu$ in. Saturation curves (b) measured at 3.24 MHz show playback voltage stays flat over broad range.

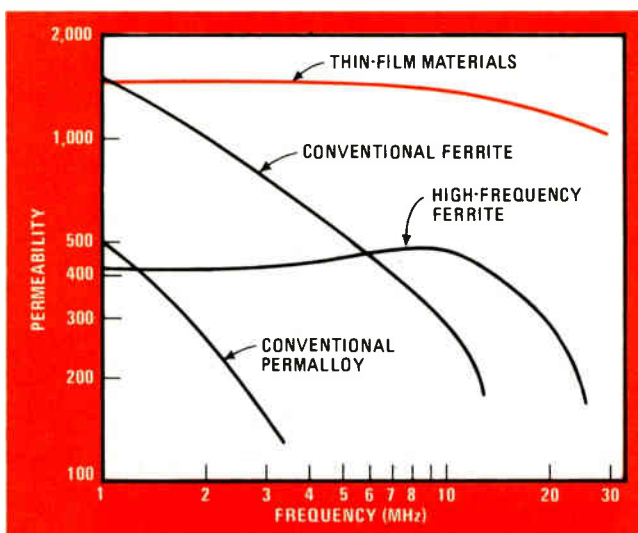

**8. Permeability.** Thin-film materials maintain superior permeability over a broad range of frequencies, compared with conventional and high-frequency ferrites and conventional permalloy materials. This characteristic translates into higher data-transfer rates.

conventional sensor. These inductances do not present a design limitation.

Unfortunately, the small dimensions of the pole piece can significantly increase core reluctance. If corrective design steps are not taken, this increase would reduce core efficiency (the ability to couple magnetic flux between the coil and the gap).

Modern conventional heads also are facing core efficiency problems at higher recording densities. These problems are due to the rapidly decreasing permeability of conventional core materials at the high frequencies required for these densities (Fig. 8).

### Increasing core efficiency

It is possible to increase core efficiency in thin-film heads by constructing the pole pieces from oriented thin films of a doped permalloy material. Such a material has much better permeability at high frequencies (Fig. 8).

An oriented film is a magnetic material that exhibits uniaxial anisotropy, meaning that it has a preferred axis of magnetization called the easy axis. In the thin-film head, it is deposited with the easy axis lying along the track width and perpendicular to the direction of motion (Fig. 9a).

When the head is idle, the magnetization in the pole pieces will lie along the easy axis with a magnitude equal to  $M_s$ , the saturation magnetization of the material. When the head is operating, the magnetization will rotate out of the easy axis so that it has components along the hard axes: the X axis (parallel to the direction of motion) and the Y axis (perpendicular to the surface of the medium).

This rotation of the magnetization produces a net flow of flux in the head. As seen in Fig. 9b for the write process, the magnetization tends to rotate into the direction of the field produced by the coil (the drive field). This process—switching by rotation—is very fast, giving high permeability and excellent frequency response.

The drive-field strength necessary to obtain complete rotation is called the anisotropy field,  $H_k$ . The permeability is proportional to the ratio of  $M_s$  to  $H_k$ . Using proper magnetic materials, it is possible to produce oriented films with high  $M_s$  and low  $H_k$ , thus yielding high permeability.

Along the easy axis, the films are inherently bistable since the magnetization can lie in either direction. The magnetization will remain unchanged until a large enough field is applied in the opposite direction along the easy axis to switch it 180° into its other stable state. The drive-field magnitude necessary to produce this switching of the magnetization is called the coercive field,  $H_c$ .

### Overcoming domain formation

Reliable recording heads cannot always be made with pole pieces consisting of single-layer oriented films. Such heads are likely to experience severe problems with Barkhausen noise during the playback process because of the presence of numerous magnetic domains in the film. The problem stems from the behavior of oriented films as permanent magnets in the absence of a drive field. This behavior causes a demagnetizing field inside

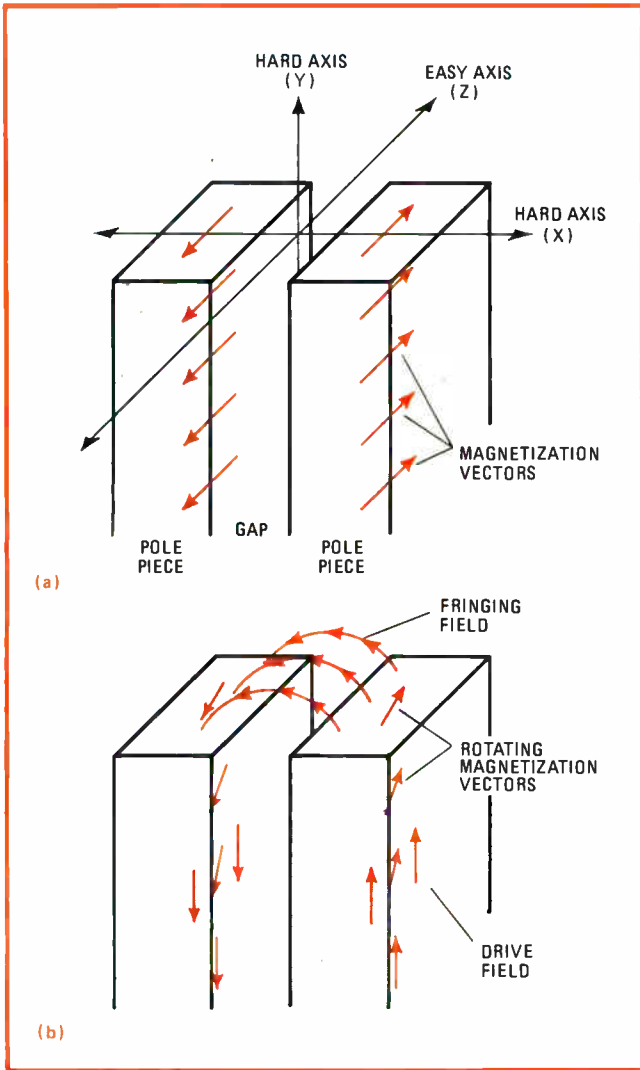

**9. Fast switching.** When the thin-film head is idle, magnetization vectors lie along the direction of the easy axis, perpendicular to the direction of motion. During operation, the magnetization rotates, producing a component along the hard axis that causes a flux flow.

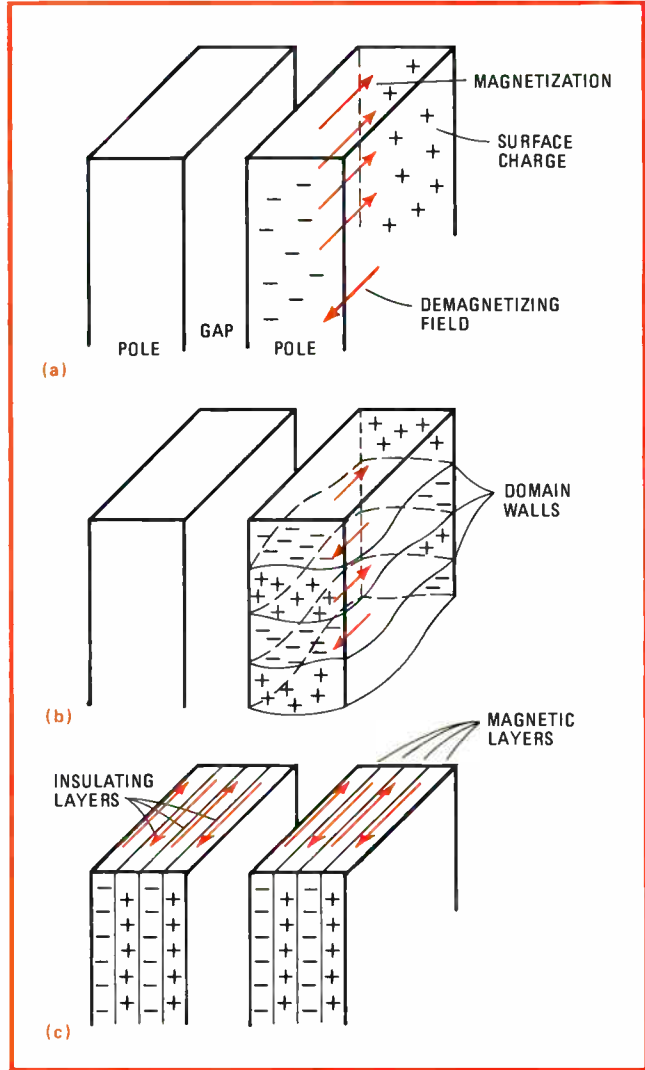

**10. Domains.** Without a drive field, films behave as permanent magnets causing demagnetizing field (a). In narrow films, domain walls form (b). Lamination of the films (c) makes layers single domains with alternating magnetizations.

the film opposed to its first magnetization (Fig. 10a).

The demagnetizing field is due largely to magnetic surface charges that occur whenever the magnetization is not parallel to an edge or surface of the film. When the films are limited in width, as with a narrow-track recording head, the demagnetizing field may become larger than  $H_c$ , causing an unstable condition.

In this unstable situation, magnetic domains with reversed magnetizations will form (Fig. 10b). Switching is no longer strictly by rotation, but also by movement of domain walls, which tends to occur in jumps rather than smoothly—causing what is known as Barkhausen noise.

Of the several ways to avoid domain formation in the pole pieces, there is one that does not compromise the permeability, design flexibility, or track density: lamination of the pole-piece structure (Fig. 10c). The magnetization in each successive layer alternates in direction along the easy axis, with each layer essentially a single magnetic domain. In effect, there are no domain walls.

At the same time, the demagnetizing fields of the

successive layers also alternate in direction, so that the demagnetizing fields cancel one another to a large extent. Moreover, this structure minimizes the possibility of eddy-current losses in the permalloy core, because each lamination provides only a very small cross-sectional area where the currents might flow.

Applied Magnetics Research has been working with several makers of computer peripherals on applying thin-film heads to tape and disk drives. Such cooperation is essential because the parameters are numerous and complex enough to require computer analysis based on data inputs from the peripheral designer as well as from the magnetic-head engineer.

Such cooperation between the peripheral designer and the head manufacturer has already provided results. This year will see the beginning of a new generation of peripherals using thin-film heads for greater data capacity, higher transfer rates, and improved track-to-track uniformity. It promises better peripherals and more cost-effective computer systems. □

## High-accuracy calibrator uses no precision components

by Walter Allen  
The Audichron Co., Atlanta, Ga.

A calibrating voltage source with an output of 1 to 10 volts in 1-v steps can achieve an accuracy of within 0.1% even though all the resistors in the circuit have  $\pm 10\%$  tolerances. The precision is obtained by digitally chopping the reference voltage with a decade counter and then integrating the varying duty cycles back into voltage steps.

As the schematic shows, the 10-v reference source is built around a feedback-stabilized operational amplifier that is one section of an MC3403 quad op amp. This reference voltage is the  $V_{DD}$  supply for a CD4017 decade counter and powers all the digital chips in the circuit as well. The CD4017 is a Johnson counter that produces 10 decoded outputs (0-9) that are pulsed sequentially.

Half of the CD4001 quad, two-input NOR gate is connected as an astable multivibrator that, going to the clock input, drives the counter at approximately 200 kilohertz. The other half of the CD4001 is configured as a set-reset flip-flop.

The flip-flop is set by the counter's decoded output 0 and reset by one of its 1-9 decoded outputs, depending on the position of the voltage step-selector switch. The flip-flop's output is therefore a rectangular pulse train of

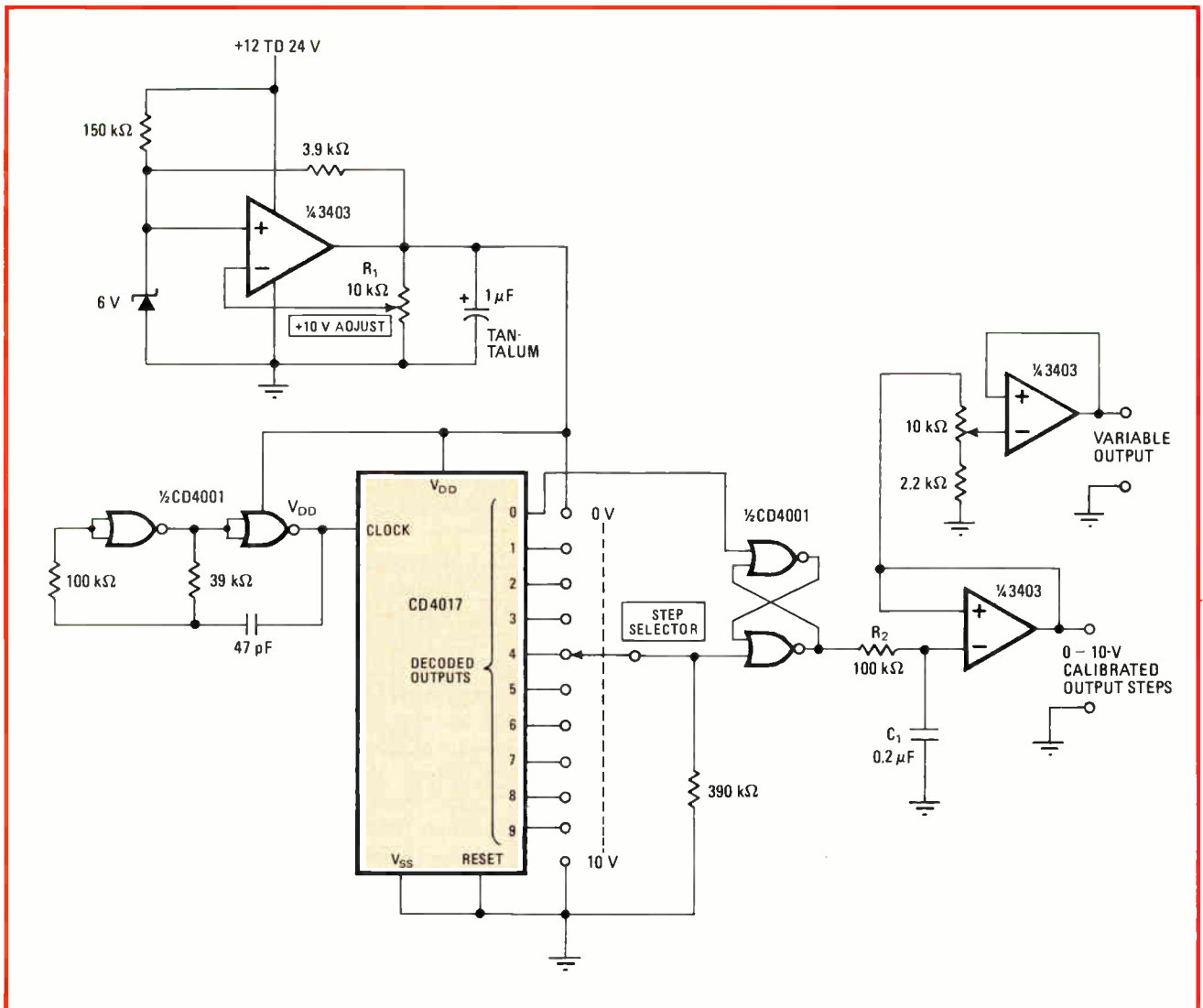

**Digital division— analog accuracy.** Changing the duty cycle of the pulse train is the key to accurate voltage division. Frequency and duty cycle of clock at left do not affect output, since decoded counter outputs accurately determine duty cycle.

approximately 20 kHz that has a duty cycle varying from 0% to 100% by 10% steps.

The signal is then integrated by the RC low-pass network and buffered by another section of the MC3403 quad op amp for output. An adjustable divider and additional op-amp follower provide stable voltages between steps.

The MC3403 quad op amp is used for its high current capability—up to 30 milliamperes—and also for its ability to swing down to within a few millivolts of the negative supply rail.

Potentiometer  $R_1$  sets the 10-v reference voltage.

When this is precisely adjusted, the 1-v switch-selectable output steps are accurate to within 0.1% with any loads up to 20 mA. The adjustable output tracks between steps with high linearity, and the 20-kHz ripple component in the output is less than 1 mV.

The capacitor in the integrating network should be a high-quality, low-leakage unit, though its value is not critical since it determines only the step response time. With the value of 0.2 microfarad shown, the response time is about 100 milliseconds. A 1.0- $\mu$ F tantalum capacitor would give better filtering characteristics, but its response time is on the order of 0.5 s. □

## Inductive kick gates SCR motor crowbar

by Buck Postlewait,  
Instrumentation Specialties Co., Lincoln, Neb.

A dc motor can be made to stop itself with a little help from an SCR. Applying a "crowbar," or direct short, across its terminals will prevent the motor from coasting. Using a silicon-controlled-rectifier crowbar permits gating by the inductive kick of the motor's collapsing fields and stops rotation of the armature within 50 milliseconds.

As shown in the figure, the switch controlling the motor is in the negative supply lead. When it opens, the tank circuit formed by capacitor  $C_1$  in parallel with the motor's windings will ring with a damped sinusoidal waveform. The negative transition of this waveform, plus the windings' back emf (which is the same polarity as the supply voltage) drive the voltage at the motor's negative terminal below ground.

Since the SCR's gate is tied to ground through the 1-kilohm resistor it is then forward-biased with respect to the cathode. The SCR fires, slowing the motor abruptly. The rectifier remains in conduction until the current flowing through it drops below the holding value—but by this time the motor is nearly halted.

This circuit is used in a motorized rotary valve system,

where the desired valve opening is obtained by running the motor for a specific amount of time; thus, quick stopping is a must. However, the crowbar can brake any small dc motor. The only design considerations would be the SCR current rating, which must be greater than the stalled current drawn by the motor, and the value of  $C_1$ , which may have to be adjusted for optimum response. □

Designer's casebook is a regular feature in *Electronics*. We invite readers to submit original and unpublished circuit ideas and solutions to design problems. Explain briefly but thoroughly the circuit's operating principle and purpose. We'll pay \$50 for each item published.

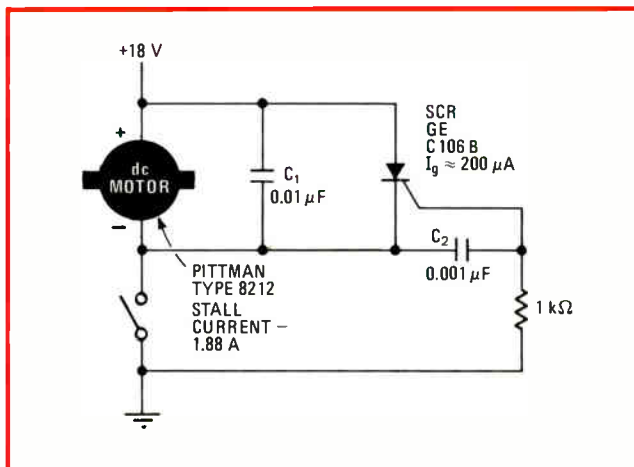

**Quick crowbar.** Opening the motor circuit generates an induced voltage which, added to signal in tank circuit formed by windings and  $C_1$ , gates the SCR. The rotation of the armature is thus crowbarred to a halt within 50 ms. Capacitor  $C_2$  prevents false triggering.

## Comparator switches regulator for foldback current limiting

by R. H. Richardson  
Melbourne, Fla.

The three-terminal regulator, while easing the design of regulated power supplies, does limit the adjustability of their output parameters. Here is a circuit that couples a comparator with a National LM317 adjustable, three-

terminal power regulator to provide independent control of output voltage and current limiting.

The power supply shown in the figure was designed as a 9-to-16-volt, 20-ampere bench regulator for automotive transceiver applications. It therefore employs high-power regulating transistors, but the technique of comparator-controlled current limiting in the output is adaptable to any power range. In this case, the current limit of the supply can be set from 1 to 20 A, independent of the output-voltage setting.

The circuit employs a foldback type of current limiting; that is, once the current limit is exceeded, the output voltage drops nearly to zero. The LM311 comparator,

# Microwaves for the masses

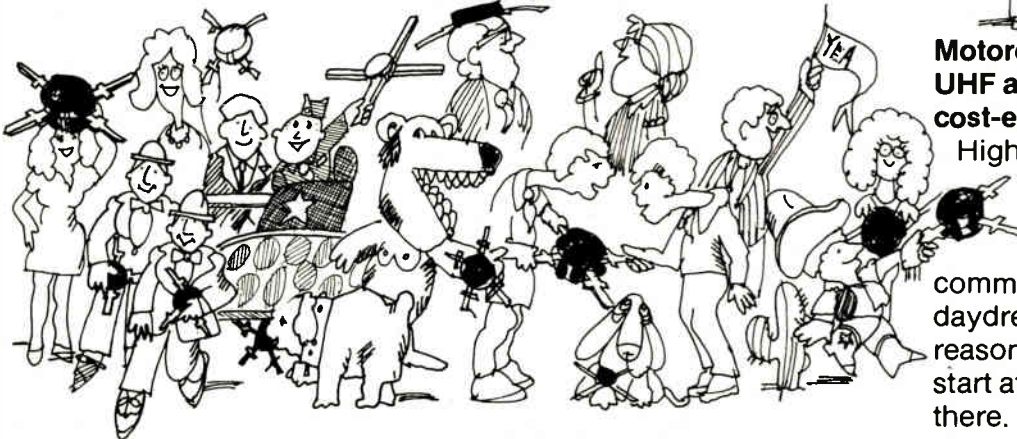

**Motorola just made everybody's UHF and microwave designs cost-effective!**

High-performance applications utilizing UHF/microwave small-signal transistors for industrial-commercial designs used to be daydreams... devices with reasonable gain and NF used to start at \$5-\$10 and went up from there. No more.

**Motorola has brought within your budget the kind of performance formerly restricted to military programs. See?...**

Small signal devices shouldn't cost a lot—and these don't. Our yields are up. Our costs are down. Our improved arsenic emitter implantation and gold metallization processes have given us savings we're passing on to you. Our case 302 plastic package performs as well as expensive ceramic types. We're ready to peg our prices to bring microwaves to the masses.

And nobody—repeat *nobody*—in the industry except Motorola is capable of supplying you with thousands of these mighty mites on moment's notice through factory or worldwide distribution.

Microwaves for the masses.  
Microwaves for you.

Write Motorola Semiconductor Products Inc., P.O. Box 20912, Phoenix, AZ 85036 for data or contact your authorized distributor or factory representative.

**BFR90**  
5 GHz typ. fr at 14 mA, 2.4 dB typ. NF at 500 MHz. Price: just \$1.60

**MRF931**  
12 dB G<sub>T</sub> at 1 GHz, 3 GHz fr at 1 mA Price: just \$1.90

**BFR91**  
5 GHz typ. fr at 30 mA, 1.9 dB typ. NF at 500 MHz. Price: just \$1.95

**MRF901**  
10 dB min. G<sub>P</sub>e at 1 GHz, 2.5 dB max NF at 1 GHz. Price: just \$3.75

**2N6603/4**  
first microwave part designed to meet MIL-S-19500/522



**MOTOROLA Semiconductors**

—still the production house.



monitoring the current flow, switches the supply into the limiting mode.

The output of the comparator goes high whenever the voltage drop across the current-sense resistor,  $R_6$ , exceeds the bias level set by the limit control,  $R_4$ . A high level at the output of the comparator turns on transistor  $Q_1$ , which in effect shorts out the voltage-adjusting resistors  $R_1$  and  $R_2$ , thus dropping down the output voltage.

The design has an inherent hysteresis: in the limiting state, just enough current flows through the sensing resistor  $R_6$  to keep the comparator turned on. Therefore the circuit does not oscillate as many other limiting regulators do—the output voltage remains near zero until the overload is removed. The action of the comparator also provides automatic recovery from the foldback point, since the circuit cannot latch in the current-limiting mode.

Transistor  $Q_2$  turns on an incandescent lamp to indi-

cate the limiting state. Since the value of the current-sensing resistor  $R_6$  is not critical, the device may be replaced with the internal resistance of a 0- to 20-A meter, if desired.

The dial of the current-limiting control can be calibrated with known output loads at a set output voltage. Control of the limiting function is primarily dictated by the biasing resistors surrounding the comparator,  $R_3$ – $R_8$ . Designs for output voltages and currents in other ranges may employ the same basic configuration of regulator and comparator, with only the biasing components needing to be changed.

The LM317 adjustable regulator, available in either TO-3 or TO-220 packages, is capable of driving loads up to 1½ amperes without the aid of power-transistor followers. In the supply shown, five power transistors—four 2N5885s and a 2N6053—are required to handle the 20-A loads. All power transistors and diodes, as well as the regulator, must have adequate heat sinking. □

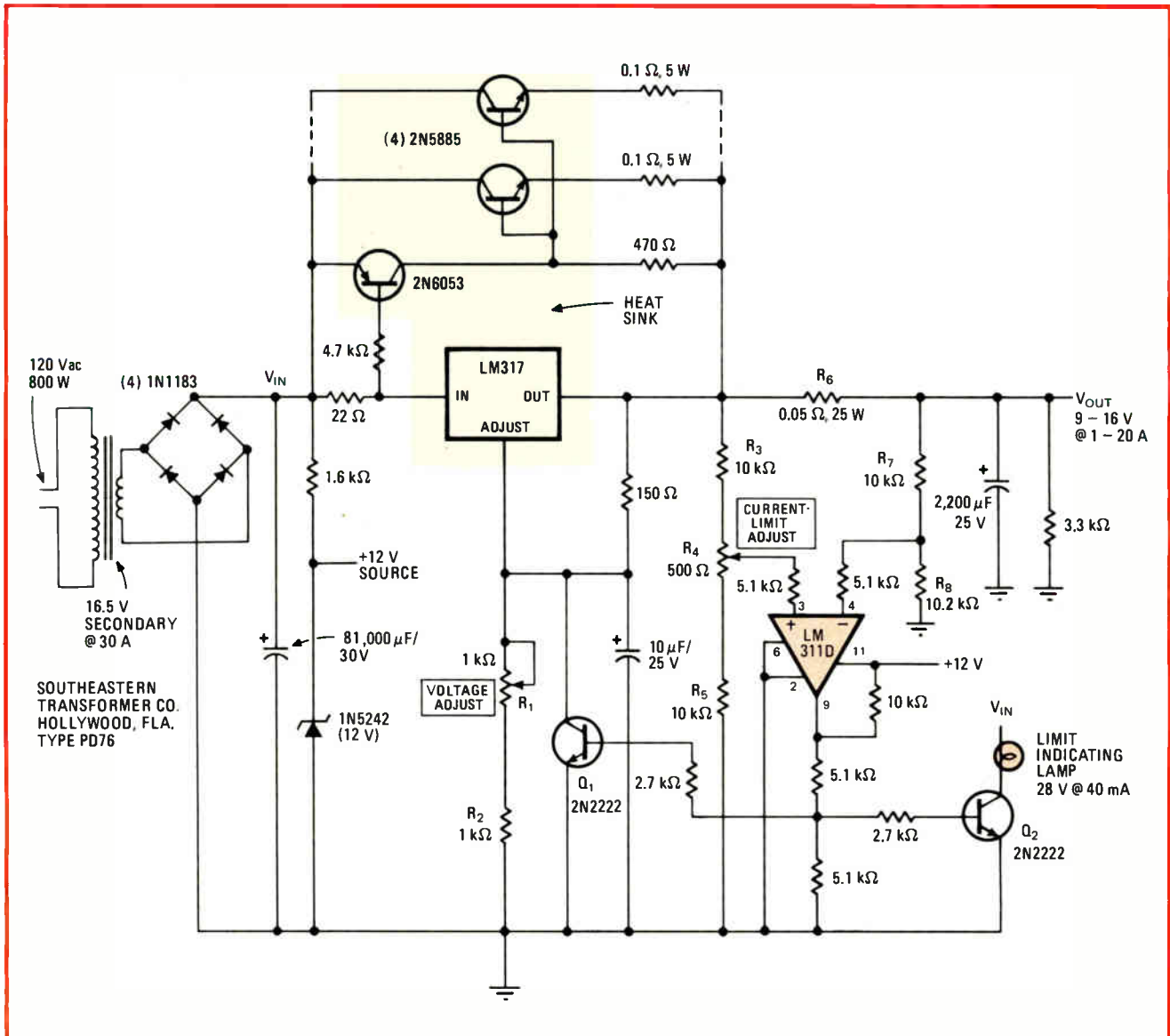

**Foldback current-limiting supply.** This supply, which has an output voltage adjustable from 9 to 16 V and provides independent current limiting from 1 to 20 A, uses a comparator to drop output voltage when the current limit set by potentiometer  $R_4$  is exceeded.

# The biggest erasable PROM yet puts 16,384 bits on a chip

Using just one 5-V supply, the ultraviolet-erasable device is interchangeable with 16-k read-only memories—a boon to designers of microprocessor systems

by Robert Greene, George Perlegos, Phillip J. Salsbury, and William L. Morgan, *Intel Corp., Santa Clara, Calif.*

□ In just two or three years, from being barely on the edge of visibility, a field-erasable read-only memory has blazed its way to prominence in the system designer's world. Because its contents can be erased with ultraviolet light, its user can program and reprogram it at will—an unaccustomed liberty.

Known as EPROMs (for erasable programmable ROMs), the devices in heavy use today are the 2,048-bit 1702A and the 8,192-bit 2708, both of which have been designed into a wide variety of equipment over the past few years. But the new 16,384-bit model, which is also faster and easier to use than its predecessors, is bound to attract old and new users alike.

The attraction, of course, is the devices' extreme usefulness for prototyping software code in microprocessor-based designs. It typically takes tens of passes through a system before a program's code can be optimized, and each pass requires a new ROM program. But a ROM that can be erased and reprogrammed quickly from standard address signals makes it much easier to optimize a program.

Indeed, individual words can be rewritten in today's UV-erasable PROMs, so that programmers can fine-tune their software well into the development cycle or change a portion of the program to accommodate new system

features. Then, once satisfied with the program, the user can switch into production with factory-programmable ROMs that have identical pin assignments and use similar power supplies.

Alternatively, as the availability of erasable PROMs increases, system designers are beginning to use them in place of standard ROMs in the production equipment itself, especially in the early sample stage and also in small-volume designs. It is an all-too-familiar problem, getting small numbers of mask-programmed ROMs from the factory in anything like a reasonable time and at less than an exorbitant per-piece cost. Here the erasable PROM is the perfect answer, for it goes straight into the equipment once its program is fixed.

## A good deal in all respects

The new Intel Corp. 2716 16-k device has all this versatility, and then some (see table). It offers twice the memory capacity on a chip only 20% larger than the 8-k version—and the smaller the die, the lower its production costs eventually fall. Its performance is better. Though its maximum access time stays at a short 450 nanoseconds, its active power dissipation per bit has been reduced to 40% of the 8-k device level, so that the chip's total power dissipation is 20% lower for 16,384 bits than

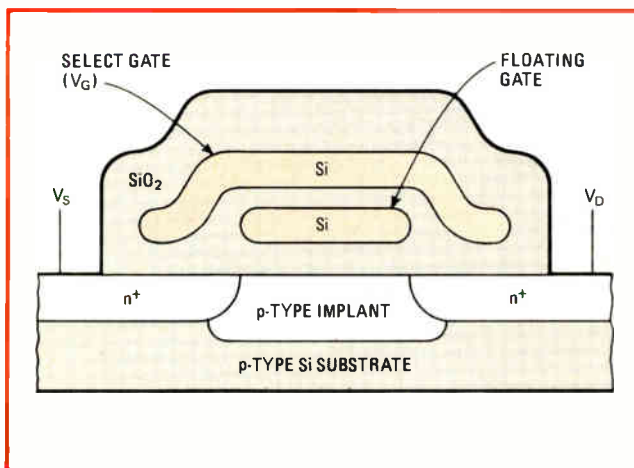

**1. Doubling up.** By using two levels of polysilicon, this stacked-gate version of the floating-gate avalanche-injection MOS cell occupies half the area of earlier Famos cells. As a result, the 16,384-bit 2716 chip is only 20% larger than the 8,192-bit 2708 devices.

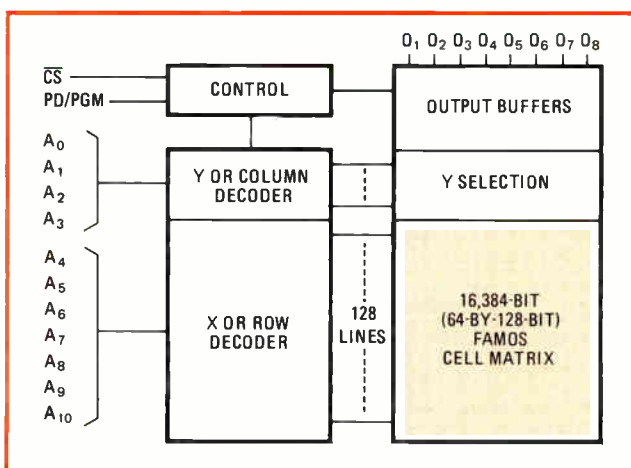

**2. Aimed at microcomputers.** The 16,384 cells in the 2716 device are organized into two 64-by-128-cell arrays or 2,048 8-bit words, an arrangement that makes the device useful for byte-oriented microcomputer designs and also compatible with 16-k ROMs.

ULTRAVIOLET-LIGHT ERASABLE PROGRAMMABLE ROMs

Year	1972	1975	1977
Model	1702A	2708	2716
<b>Basic features</b>			
Technology	p-MOS	n-MOS	n-MOS
Organization	256 X 8	1,024 X 8	2,048 X 8
Chip area (mil <sup>2</sup> equiv.)	134	160	175
Package pins	24	24	24
<b>Read performance</b>			
Access time (max) (ns)	650	450	450
Power dissipation (mW)	700	730	500
"    "    per bit (mW)	0.4	0.1	0.04
Standby power (mW)	*	*	125
"    "    per bit (mW)	*	*	0.006
Power supplies (V)	+5, -9	+5, +12, -5	+5
TTL compatibility	yes	yes	yes
<b>Programming requirements</b>			
Supply voltages (V)	+12, -35, -48	+26, +5, +12, -5	+25, +5
"    "    pulsed, V <sub>P</sub>	yes	yes	no
Program control levels (V)	0/-48	0/+12	TTL
Address and data inputs (V)	0/-48	TTL	TTL
Duty cycle (%)	20	80-100	80-100
<b>Programming performance</b>			
Programming time of all words (s)	120	100	100
"    "    per word (s)	0.4	100	0.05
Single-pulse programming	no	no	yes
Single-location programming	yes	no	yes
Erase time of all words (minutes)	10-20	10-30	10-30

\*Power dissipation can be reduced by clocking power supply or turning off during deselect

it was for 8,192 bits. In fact, the 2716's speed-power product, at 450 ns and 500 milliwatts, puts it on a par with standard high-density ROMs. Moreover, the chip's low standby power mode, in which it dissipates only 125 mw, affords further power savings at the system level.

Equally important, the 2716 works off a single 5-volt power supply, in contrast to the earlier multiple-supply 1702A and 2708 devices. This change is vital for today's designs, since it allows the device to be used with the new, more powerful 5-v microcomputers. In fact, another device using the same basic cell concept, the 8755, has been designed with special input/output ports and control lines to work directly with the 5-v Intel 8085 microcomputer, as well as with other types of 5-v microprocessor systems.

In applying the new 16-k 2716 in microprocessor-based systems, the system designer not only replaces two 2708 packages with one 2716, but he or she can also eliminate the 1-of-4 decoder chip that is needed with the two earlier devices. Indeed, when hooking up the 2716 to single-chip microcomputers such as Intel's 8048, only a standard, commercially available 8212 latch is used, as with the 2708 configuration, and nothing else. All other control signals and address signals are supplied by the processor.

Finally, the new devices are easier to program than the earlier ones. They need only two programming supply voltages (+25 and +5 v) instead of three and four different voltage levels (some as high as 48 v) typical of UV-erasable PROMs. Moreover, the program voltage V<sub>P</sub> need not be a low-duty-cycle pulse, so that program time is greatly reduced—from 100 seconds to 0.05 s per bit—even while control levels and address and data inputs are

### The Famos principle

Famos describes the floating-gate avalanche-injection metal-oxide-semiconductor transistor that Dov Frohman-Bentchkowsky developed at Intel Corp. in 1971.

The Famos device is essentially a silicon-gate MOS field-effect transistor in which no connection is made to the floating silicon gate. Instead, charge is injected into the gate by avalanches of high-energy electrons from either the source or the drain. A voltage of -28 volts applied to the pn junction releases the electrons.

Data is stored in a Famos memory by charging the floating-gate insulator above the channel region. The threshold voltage then changes, and the presence or absence of conduction is the basis for readout.

The Famos cell has generally been considered more reliable than nitride storage mechanism used in reprogrammable metal-nitride-oxide-semiconductor memories. In MNOS memories, carriers tunnel through a thin oxide layer into traps at the oxide-nitride interface. But a partial loss of stored charge during readout limits the number of readout cycles to approximately 10<sup>11</sup>.

In Famos memories, on the other hand, there is no loss of charge due to reading. Moreover, over time, the loss of stored electrons is negligible, less than one per cell per year, and information retention is excellent.

kept at straight 5-v transistor-transistor-logic levels.

All these improvements flow from a new n-channel stacked-gate cell that uses just one transistor. This cell is fabricated with a dual-layer silicon-gate process that closely resembles the one used in today's 16-k dynamic random-access memories. As the cross section in Fig. 1

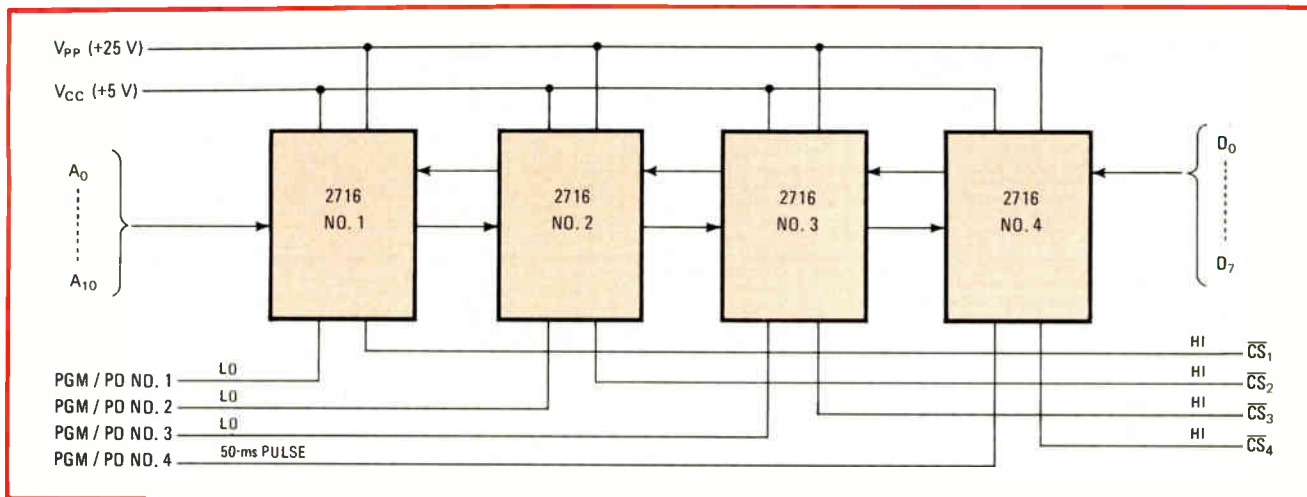

**3. Picking and choosing.** The 2716 erasable PROM has a program inhibit mode, to allow the designer of a multipackage system to program some of the devices and not others. Only those devices that receive a TTL-level pulse on the PGM/PD pin will be programmed.

shows, a lower floating gate stores the cell's charge, and an upper control or select gate operates the cell. Being stacked one over the other, the gates create an extremely compact structure—the smallest cell of any UV-erasable PROM in production. Including decode, address, drive, and sense circuitry, the entire memory fits on a chip well under 40,000 mil<sup>2</sup> in area.

As for the cell's operation, the fact that it has a fairly complicated stacked-gate configuration is completely transparent to the user. Unlike the 1702A erasable-PROM floating-gate cells (see "The Famos principle," p. 109), the stacked-gate cell is programmed by means of hot electrons injected from the channel through the oxide to the floating gate. This injected charge raises the threshold voltages at the top or select gate, so that a charged cell has a higher select voltage than an uncharged cell. The overall charge pattern, then, as seen from the select gates, duplicates the pattern of a standard mask-ROM.

Once programmed, the charge retention of the new 16-k UV-erasable PROM is as good as in the original Famos devices. Reliability studies of standard production runs indicate that 95% of the devices can be expected to retain their memory for 100 years at 70°C. Charge removal from the stacked-gate cell occurs with its exposure to ultraviolet light, just as in both the earlier UV-erasable devices.

### Using the 2716

The array of 16,384 Famos cells, which are formed into two 64-by-128-cell matrixes (Fig. 2), is organized as 2,048 8-bit words, giving the 2716 a byte orientation that is useful in microcomputer applications. Because of this arrangement, the device operates almost exactly like the 2708 8-k erasable-PROM. The only differences are that on the 2708 device the power-supply voltages V<sub>DD</sub> and V<sub>BB</sub> are on pin 19 and pin 21 respectively, whereas on the 2716 device the address A<sub>10</sub> is on pin 19 and the program voltages (+25 v for programming, 5 v for reading) are on pin 21.

Otherwise, complete data and power-supply compatibility exists between the familiar 2708 and the new 2716:

they plug into exactly the same sockets, having exactly the same standard 24-pin package and the same pin assignments (except for those mentioned above). The one change in designing a board with a 2716 is that programming it requires a +25 v power supply and reading it takes a 5-v supply instead of the 26-v pulses needed for programming and the ±12 v, +5 v, and -5 v supplies needed for reading the 2708.

As for ease of use, the 2716 compares well with ordinary ROMs. The seven highest-order address bits, A<sub>4</sub> to A<sub>10</sub>, select the rows, while address bits A<sub>0</sub> to A<sub>5</sub> select the columns and operate on eight 1-of-16 decoders, such that one of 16 column lines is gated to each of the eight output buffers.

Sensing is the same as in the 2708 devices. The charge on the selected column line is monitored. Unprogrammed cells will have a low threshold and will discharge the column line when selected, while the threshold of programmed cells will have been raised to an impedance level that is high enough to keep the column line charged.

To read the 2716, the chip-select input is the only control input required. Lower this input to a transistor-transistor-logic 0 and the device reads; raise it to a TTL 1 again and the device stops reading—is deselected. When deselected, this chip-select input causes the outputs to go into the high impedance state within about 120 ns, a time short enough to allow a designer to OR-tie several 2716s in parallel yet still retain the maximum 450-ns access times of individual devices. On the other hand, since chip select is really an enabling signal, if only one or two 2716s are being used in a system, they may be left low during all cycles, allowing a designer to exploit the typically faster access times of any individually selected devices.

Writing and erasing are no big chores, either. Initially, and after each erasure, all bits of the 2716 are in the logic 1 state (output high). Data is written by selectively programming 0s (output low) into the desired bit locations. To set up the 2716 for programming, the program power supply, V<sub>PP</sub>, is raised to 25 v, and the chip-select is raised to the input high-voltage state (V<sub>IH</sub>) or 2.2 v

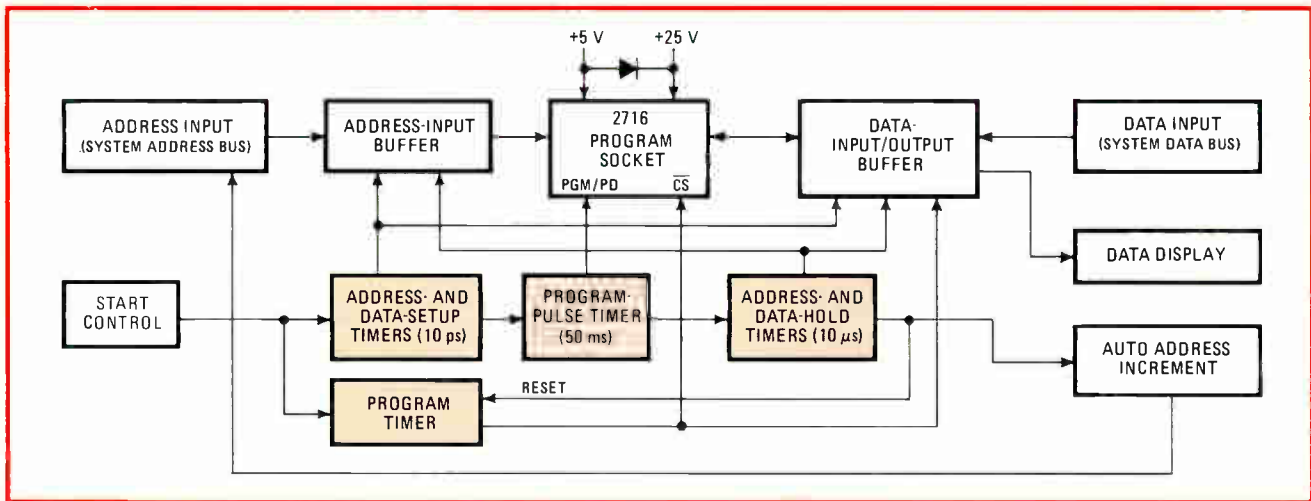

**4. Programming made easy.** In this setup, the user need only observe the appropriate setup times for the programming operation to succeed. The start control signal gets the timing chain moving, and from then on things are practically automatic.

minimum. The data is then presented, 8 bits in parallel, on the data output lines ( $O_1$  to  $O_8$  in Fig. 2), while the corresponding address is presented to the address inputs.

After the address and data setup times have elapsed, a program pulse is applied to the programming PGM/PD pin. This pulse is a TTL-level signal that serves to gate the program power supply,  $V_{pp}$ , into the array. It must be present for at least 50 milliseconds to ensure long-term retention of the programmed data. When this program is completed, the  $V_{pp}$  pin should be returned to +5 v.

Finally, erasing the 2716 is the same as for all UV-erasable PROMs. The user places it under an UV lamp and exposes it to the equivalent of 15 watt-seconds/cm<sup>2</sup>. Although there is no evidence that extended exposure harms the device, the lamp should be placed on a timer and shut off after 30 minutes to prevent unduly long (overnight and over-weekend) accidental exposure.

A useful feature of the 2716's program design is its program-inhibit mode. In multipackage systems, this mode lets the designer ignore some of the devices on a given board and only program or reprogram the rest. The setup is shown in Fig. 3. All inputs and outputs are tied together except for PGM/PD. Only those devices that receive a TTL-level pulse on the PGM/PD pin will be programmed. In the setup shown, device No. 4 is being programmed with a 50-millisecond pulse on this pin, while the address contents of the other three devices are unaffected.

The programming schemes devised for the 2716 are easier than for previous UV-erasable PROMs, as may be seen from the example diagrammed in Fig. 4. In this scheme, the addresses and data may be derived from a microcomputer system bus. Alternatively, the user can generate both manually, employing toggle switches for control and a counter for address input. However, when manual operation is performed, a provision must be made for automatic incrementing of the address pulses.

In either case, a start control signal enables the timing chain shown in Fig. 4, assuring that the appropriate setup times are observed. This signal also enables the program timer, which controls the 2716 chip-select

### From PROM to final ROM—fast

Since the UV-erasable 16,384-bit 2716 user-programmable ROM is pin-compatible with the 2316E mask-programmed 16-k ROM, designers can debug systems with the 2716 and, as soon as the data pattern is firm, order read-only memories to plug directly into the 2716/2316E socket. In fact, the initial system can be shipped with erasable PROMs and fitted with ROMs in the field when they become available. Also, the 2716 can be used as the master for transmitting the desired data pattern back to the factory without all the hassle of tape formats.

This direct interchangeability between the 2716 and the 2316E can also speed up implementing code changes. In the past, even when systems were successfully prototyped with UV-erasable PROMs and released to production using mask ROMs, the slightest code change forced the end user to wait while the new code was implemented on the prototype system, then translated into a ROM pattern, and only then placed in the production system. But when the 2316E is used in production systems, any change in code can be performed in a matter of a few hours by programming a 2716 with the custom pattern and plugging it in.

signal, and places the data input/output buffer in the input mode. The program timer must be reset after the address and data hold times have passed.

Once started, the address and data-setup timers enable the program pulse timer, which applies the required TTL pulse to the 2716 PGM/PD pin. This pulse, in turn, on its falling edge, enables the address- and data-hold timers. After they have finished, the auto-address-increment timer does one of two things. Either it advances the address-input counter to a manual programmer, or it resets a not-busy flag on a microprocessor. The program timer is then reset, placing the data I/O buffer in the output mode for data verification. Note that the  $V_{pp}$  (+25-v) supply does not have to be turned off or switched during program/read transitions. However, it should be lowered to VCC for nonprogramming operation to reduce power dissipation. □

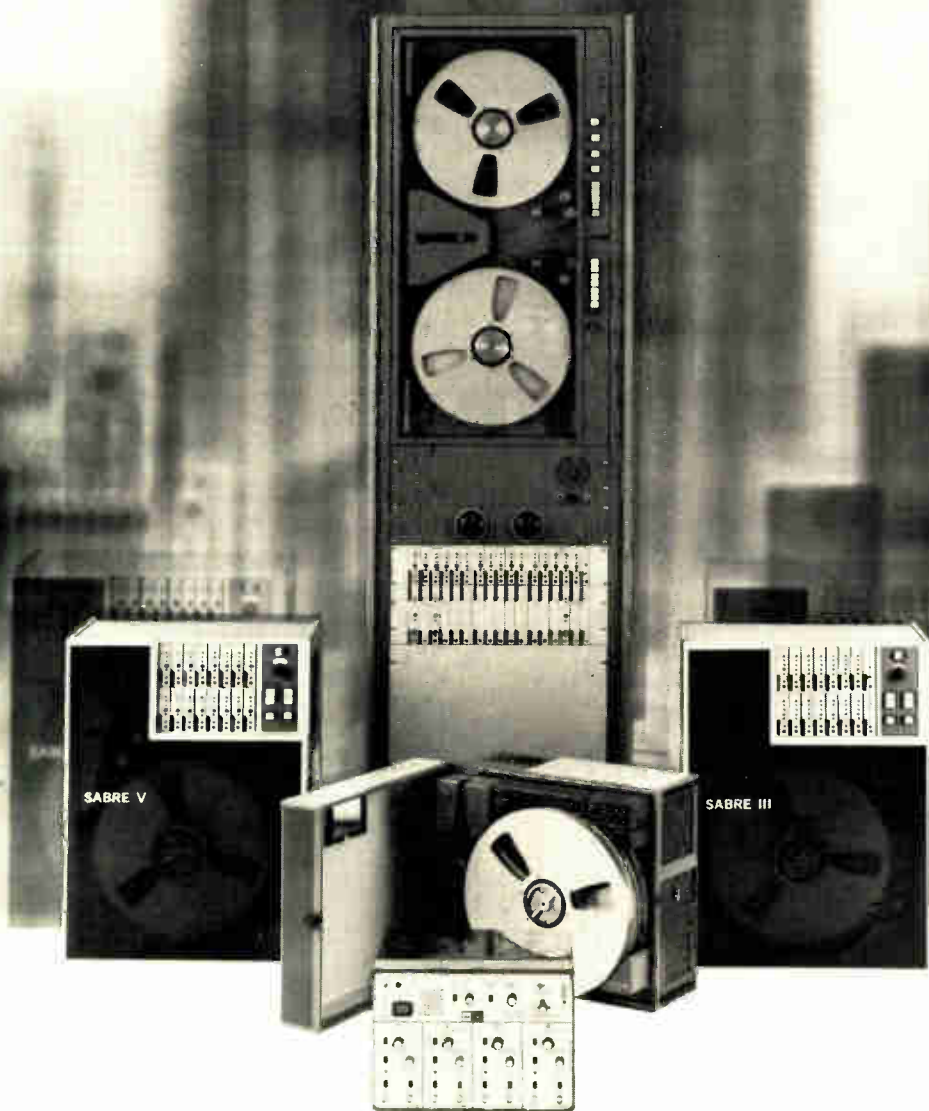

## Now our expandable line offers DC to 4 million bits per second!

We offer PCM capability, in addition to Direct and FM electronics, in three of our recorder/reproducers. There's the 7 to 14 channel Sabre III and the 28/32 channel Sabre V, both IRIG all-band portable recorders; and the Sabre IV, a 7 to 48 channel laboratory recorder/reproducer.

In addition our line includes the new Sabre VI which offers superior performance plus ultra-portability, and the Tandberg TIR-115, a 4-channel, FM, 25-pound system.

Those basic five recorders are actually an almost unlimited line because each is designed and built to adapt to an amazing variety of functions. Just tell us what you want one to do!

For information write: Sangamo Data Recorder Division, P.O. Box 3347, Springfield, Illinois 62714. 217, 544-6411. Telex 406-461. Sales and service representatives worldwide.

**SANGAMO WESTON**

**Schlumberger**

# Hybrid transformers prove versatile in high-frequency applications

At frequencies up to 1 MHz, they can be used for duplexing, proximity-sensing, or making intermodulation measurements

by Tom Gross, T. A. O. Gross & Associates, Lincoln, Mass.

□ Most hybrid transformers—the three-winding type used for telephone applications—do not operate beyond the voice-frequency band. However, if their frequency range is extended, they can easily perform a number of other tasks. Among these applications are:

- Duplexing a single transducer for both transmit and receive functions in ranging systems and ultrasonic detectors for camera focusing and intrusion alarms.
- Measuring intermodulation distortion when a device must be driven by several signal sources that should not interact.
- Coupling several transducers to common drivers so that the harmonics generated in one transducer are not reproduced in another one.
- Making return-loss measurements in the frequency domain.
- Proximity sensing of metallic objects.

The transformers used for all of these applications can be made with standard materials without the need of special winding machinery. If the turns ratio is unity, the winding may be a simple trifilar structure, which gives excellent coupling and winding symmetry. In fact, this construction may be used for operating frequencies as high as 1 megahertz with the popular termination impedance of 50 ohms.

## Ins and outs of the hybrid transformer

The hybrid transformer is valuable for many applications because it can couple circuits to a common terminal without coupling them to each other. The device consists of three closely coupled windings, two of which are connected in series-aiding fashion (Fig. 1a). In general, the two series-connected coils have an equal number of turns, so that  $N^2 = Z_4/Z_3$ , where  $Z$  is the termination impedance, and  $N$  is the ratio of the number of turns of the "floating" winding to the number of turns of one of the series windings.

When each port is terminated properly, this configuration yields a four-port device having the truth table of Fig. 1b. Ports 1 and 2 are both coupled to ports 3 and 4, but they remain isolated from each other. Similarly, ports 3 and 4 are connected to ports 1 and 2, but not to each other.

Hybrid transformers tend to differ from conventional coupling transformers in the care exercised to achieve winding symmetry, high magnetic coupling, and high

shunt reactance over the operating-frequency range. However, most ordinary power transformers having three windings may be used as hybrids over limited ranges of operating frequencies and termination impedances. The special coupling properties of the hybrid transformer result from bridging of external impedances, rather than arcane processes inside the device.

## How the isolation works

The operating action of the hybrid transformer may be explained readily by mesh equations, but an intuitive understanding is more helpful for applying the device. A simple assumption helps to explain the operating principle: Let each of the three windings have  $N$  turns (unity turns ratio), and let all the termination impedances be equal so that  $Z_1 = Z_2 = Z_3 = Z_4$ .

The isolation between ports 3 and 4 is easiest to understand. If all the voltage sources except  $E_3$  are shorted, the current generated by  $E_3$  divides equally, flowing in opposite directions in the series windings. No net flux is produced in these windings to induce a voltage in the winding of port 4. To port 3, ports 1 and 2 appear

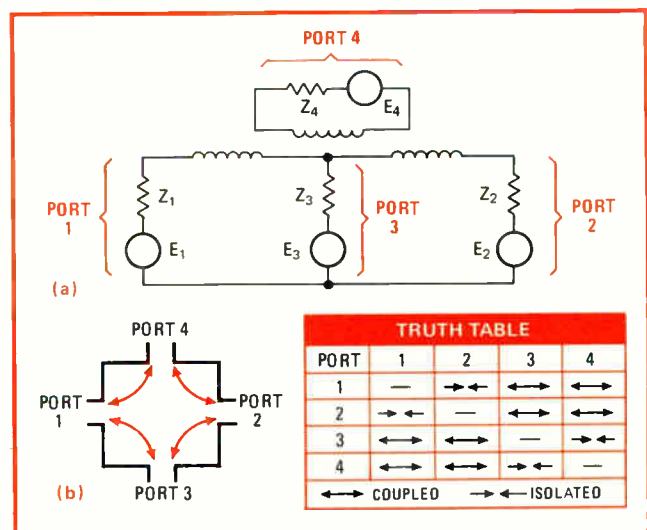

1. Basics. Hybrid transformer (a) is a four-port device formed by three windings, two of which are connected in series. As the truth table (b) shows, ports 1 and 2 are coupled to ports 3 and 4, but isolated from each other. Likewise, ports 3 and 4 are also isolated.

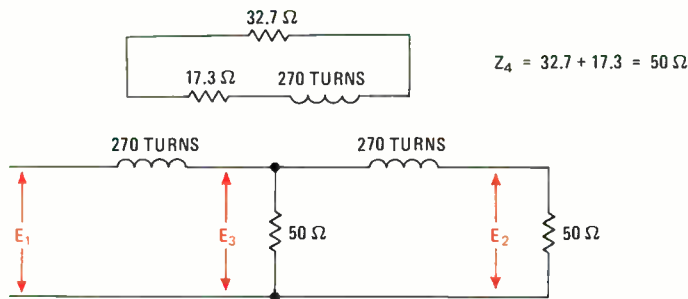

TEST RESULTS	
Frequency (Hz)	E <sub>1</sub> /E <sub>2</sub> (dB)
50	22
100	28
500	41
1,000	49
40k	50
100k	45
500k	34
1,000k	22

#### CONSTRUCTION DETAILS

Coil resistance: 17.3 ohms  
 Inductance: 220 mH at 1 kHz  
 Core: Magnetics Inc. G42616-UG or Ferroxcube 26/16-3B7  
 Bobbin: two-section 26/16  
 Winding: 270-turn trifilar, 135 turns on each bobbin section of three strands of gauge-36 film-insulated wire, twisted approximately one full turn of 3 strands per inch

to be connected in parallel; therefore, if  $E_4$  is the source, a current circulates in the series-windings' loops, yielding equal but opposite voltages that cancel at port 3.

The isolation between ports 1 and 2 is a bit harder to grasp, but it can be illustrated by assuming that  $E_1$  is the only active source and that the other three sources are shorted. If no current flows in  $Z_2$ , the only impedance reflected in the left side of the tapped winding is that of  $Z_4$ , which has been presumed to be equal to  $Z_3$ , as well as  $Z_1$ . So, if  $E_1$  were 3 volts, 1 v would appear across  $Z_1$  and 1 v across  $Z_3$ . Also, 1 v would be induced across  $Z_4$  and 1 v across  $Z_2$ . Since this latter voltage is equal and opposite to the 1 v across  $Z_3$ , no net voltage would be present at port 2.

Although  $Z_3$  must exactly equal  $Z_4$  to preserve the isolation between ports 1 and 2, impedances  $Z_1$  and  $Z_2$  may have any value from zero to infinity without impairing the isolation of their respective ports. But if power matches are desired—as they usually are—the impedance of ports 1 and 2 must equal the series contributions of ports 3 and 4 so that  $Z_1 = Z_2 = 2Z_3 = 2Z_4$ . To satisfy these impedance relationships and for a unity turns ratio,  $Z_3$  is usually matched to the parallel impedance of  $Z_1$  and  $Z_2$ , while  $Z_4$  is matched to their series impedance.

#### What affects performance

Transformer performance is affected in different ways by inductance, coil resistance, capacitance, and coupling. Low inductance, for example, reduces the isolation between ports 1 and 2, and, as the frequency decreases, it increases the coupling insertion loss between these two ports, as well as port 4. If coil resistance is high, coupling insertion loss becomes large, and drift in the coil resistance of the port-4 winding even adversely affects the isolation between ports 1 and 2.

Excessive capacitance limits the transformer's operating frequency, although this effect may be diminished by low termination impedances. Capacitance symmetry, another important factor, may be aided by floating the port-4 winding and termination impedance above ground. Insufficient coupling, the principal fault of

**2. Simple structure.** Hybrid transformer for ultrasonic applications may be built with standard materials and without special winding machinery. The core is a ferrite cup, and each coil consists of 270 turns of a trifilar winding of film-insulated wire.

ordinary power transformers pressed into hybrid service, limits the maximum operating frequency, as well as the highest usable values of the termination impedances.

Despite these possible hindrances, the performance needed from a hybrid transformer for broadband operation is quite easily obtained, so long as the application involves a fairly high minimum operating frequency and low-value termination impedances. If the transformer is not to operate at low frequencies, it need not have a large number of turns, and a broad variety of commercially available ferrite pot cores may be used for the construction of the transformer.

#### Building one is not difficult

Above mid-audio frequencies, ferrite-cup cores, which come with convenient coil bobbins, are appropriate. Standard off-the-shelf hybrids for 600-ohm telephone use may be employed well below voice frequencies with a proportionate reduction in terminating impedances. For close coupling and broad bandwidth, trifilar windings may be used at frequencies up to about 1 MHz. However, at termination impedances higher than 50 ohms, a trifilar construction may prove troublesome because it produces considerable interwinding capacitance.

Several different constructions are suitable for a high-frequency hybrid transformer. Figure 2 shows one for applications at ultrasonic frequencies. This structure provides excellent isolation between ports 1 and 2 over the range of 500 hertz to 500 kilohertz. Its low-frequency performance can be improved by wrapping more turns of a smaller-diameter wire, but this causes insertion loss to go up. Also, connecting the useful load to port 3 rather than port 4 halves the insertion loss caused by coil resistance, and the load may be driven down to dc. Of course, when the load must be floated above ground, port 4 is appropriate.

Furthermore, termination impedance  $Z_4$  may be absorbed entirely into the coil resistance at port 4 by simply winding the coil with smaller-diameter wire. This leaves more room for using larger-diameter wire for the other two coils, thereby reducing insertion loss. However, such a modification may cause excessive transformer heating in power applications so that hybrid balance drifts with temperature. Using nichrome or



Manganin wire for the port-4 winding will ensure hybrid balance over a wide range of temperature.

Since this particular transformer design is intended for ultrasonic applications, a ferrite-cup core is the optimum technical choice. Because such a transformer structure can accommodate frequencies much lower as well as much higher, it is ideal whenever a single unit must be put together in a hurry. As a rule, a laminated-metal core is the better choice for low-frequency transformers slated for production volumes and a ferrite core for rf applications.

### Applying the hybrid transformer

For duplexing operations, a hybrid transformer is hard to beat for its extreme simplicity and excellent coupling properties. The transmitter and the receiver are connected to a common transducer, as shown in Fig. 3a for a sonar system, in which the isolation between ports 1 and 2 prevents receiver overload.

To avoid the loss in port 4 of half of the transmitted signal energy, as well as half of the received signal energy, the terminating impedance of this port is set equal to the impedance of the transducer minus the coil resistance of the port-4 winding; in other words, the coil resistance becomes part of that port's termination. The coil resistances of the other two windings have no first-order effects on isolation or termination impedance.

Return loss may be measured with the identical setup—simply replace the transducer at port 3 with the device to be tested. Return loss is usually measured in the time domain (by pulsing the device under test and monitoring its response with the receiver). However, a hybrid transformer enables return loss to be measured in either the time or frequency domain.

Yet another application is measuring intermodulation distortion. In the circuit of Fig. 3b, the hybrid transformer is coupling two signal generators to the device under test at port 3, thereby eliminating spurious intermodulation between the generators, and the use of ports 1 and 2 for the signal sources permits coupling down to dc. Isolation between these two ports is lost when the winding reactance is no longer large, compared to the impedance of the device under test. However, in many applications, this loss in isolation at low frequencies can be tolerated.

A hybrid transformer can also couple two transducers together while isolating each from undesirable harmonics generated in the other. For example, in a hi-fi system, a hybrid transformer can prevent harmonics caused by woofer nonlinearities from passing through the high-pass section of the crossover network and being reproduced by the tweeter. The transformer isolates the tweeter from the woofer while both are driven by a common source, as illustrated in Fig. 3c. However, with this circuit, applying the negative feedback needed for woofer damping is difficult because of the high value required for  $Z_4$ , the amplifier's output impedance.

In the final and perhaps most intriguing application, the hybrid transformer may be operated as a proximity sensor to detect the presence of metallic objects. In fact, a proximity sensor based on a hybrid transformer provides greater sensitivity than most other circuits

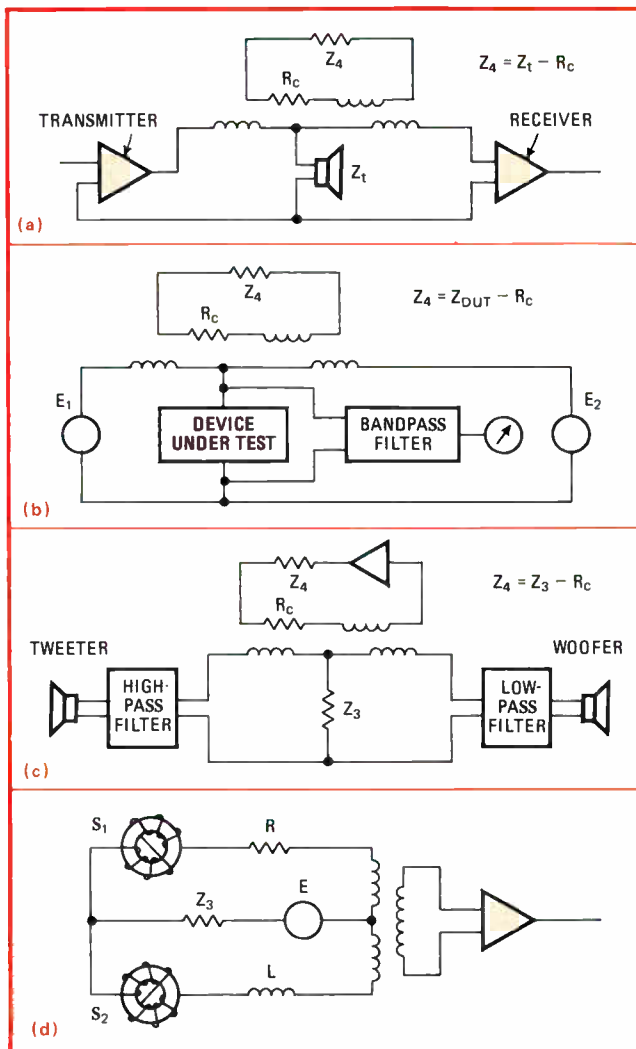

**3. Versatile.** Besides telephone applications, the hybrid transformer may be used as a duplexer (a) in sonar systems, for intermodulation measurements (b) with coupling down to dc, as a woofer-tweeter isolator (c) in hi-fi systems, and as a proximity sensor (d).

because it permits high-gain amplification at port 4 for canceling noise sidebands of the oscillator signal.

Figure 3d shows a typical setup. Toroid  $S_1$  is wound to minimize the effects of external fields, while toroid  $S_2$  is wound to maximize ulterior effects. Since the  $Q$  and inductance of  $S_1$  are higher than those for  $S_2$ , the resistor and inductor are needed to balance the impedances at ports 1 and 2 (when no metallic targets are present). A conducting object near  $S_2$  causes this toroid's  $Q$  to drop and its inductance to change, thereby varying the impedance at port 2 and producing a signal at port 4. (Below oscillator frequencies of about 15 kHz, ferrous objects generally increase  $S_2$ 's inductance.) □

#### Bibliography

- K. S. Johnson, "Transmission Circuits for Telephonic Communication," Van Nostrand, N.Y., 1925.
- A. A. Albert, "Electrical Communication," John Wiley & Sons, 1950.
- Pender and McIlwain, "Electrical Engineers Handbook: Communication—Electronics," 4th ed., pp. 6–12, John Wiley & Sons, 1950.
- A. J. Eisenberg, "Telephone Coupling Transformers," Microtran Co. Inc., Valley Stream, N.Y., Engineering F232, 1975.
- T. A. O. Gross, "Super Toroids with Zero External Fields," Electronic Design, Sept. 1, 1976, pp. 110–112.

## Self-stabilizing op amp has low temperature coefficient

by Joseph M. Gorin  
Hewlett-Packard Co., Loveland, Colo.

Circuits involving precision references require precision operational amplifiers—expensive, premium-grade units that offer low temperature coefficients of a few microvolts drift per °C. However, you can get that low thermal coefficient from a common dual audio op amp such as the Fairchild  $\mu A739$  or  $\mu A749$ , if you use half of the package to regulate the temperature of the other half.

One of the op amps is connected as a closed-loop chip-heating system that maintains a temperature about 25°C above room temperature within the package. This regulation produces a maximum thermal coefficient in the companion op amp of 6 microvolts/°C, which can be reduced to less than 1.5  $\mu V/^\circ C$  if the offset adjust of the op amp is trimmed.

The equivalent circuit of the  $\mu A749$  dual audio op amp half used to regulate the temperature is shown in Fig. 1. Output transistor  $Q_7$  is the chip-heating element, and diodes  $D_5$  and  $D_6$ , exhibiting a thermal coefficient of  $-.3\%/^\circ C$ , are the sensors that regulate collector current of  $Q_3$ . Biasing the differential pair of  $Q_1$  and  $Q_2$  off and

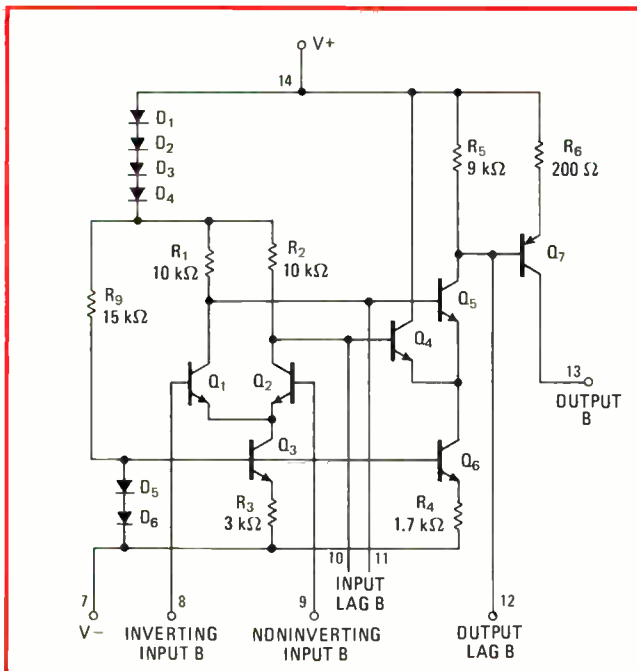

**1. Half a  $\mu A749$ .** This circuit is equivalent to one audio amp in a dual package. Transistor  $Q_7$ , used as a chip-heating element controlled by the thermal dependence of  $Q_3$ , stabilizes other amp in the package, producing a thermal coefficient rivaling precision units.

on, respectively, directs all of  $Q_3$ 's collector current through  $Q_2$  and produces a thermally dependent voltage across  $R_2$ . The variation is about 7  $mv/^\circ C$ , but the thermal coefficient of  $R_3$  opposes this with about 2  $mv/^\circ C$ . The voltage change is amplified by the  $Q_4$ - $Q_5$  differential pair that controls the current through  $Q_7$  and hence the chip temperature.

For example, as the chip gets warmer because of a rise in the ambient temperature, the collector current of  $Q_3$  gets smaller and the voltage drop across  $R_2$  decreases. Since the upper end of  $R_2$  is clamped, the lower end sees a rise in voltage, increasing the base voltage of  $Q_4$ . The differential signal unbalances  $Q_4$  and  $Q_5$ , reducing the drop across  $R_5$  and thus the current in  $Q_7$ . The chip is heated less, and its temperature decreases.

The system is shown in Fig. 2. Op amp B is the heater that stabilizes A. Resistors  $R_{11}$  and  $R_{12}$  bias the differential input ( $Q_1$  and  $Q_2$  in Fig. 1), and  $R_{13}$  and  $R_{14}$  determine the temperature of the chip by setting a reference voltage for the second differential pair ( $Q_4$  and  $Q_5$  in Fig. 1). Potentiometer  $R_{14}$  permits adjustment of the chip temperature to about 25°C above ambient. If

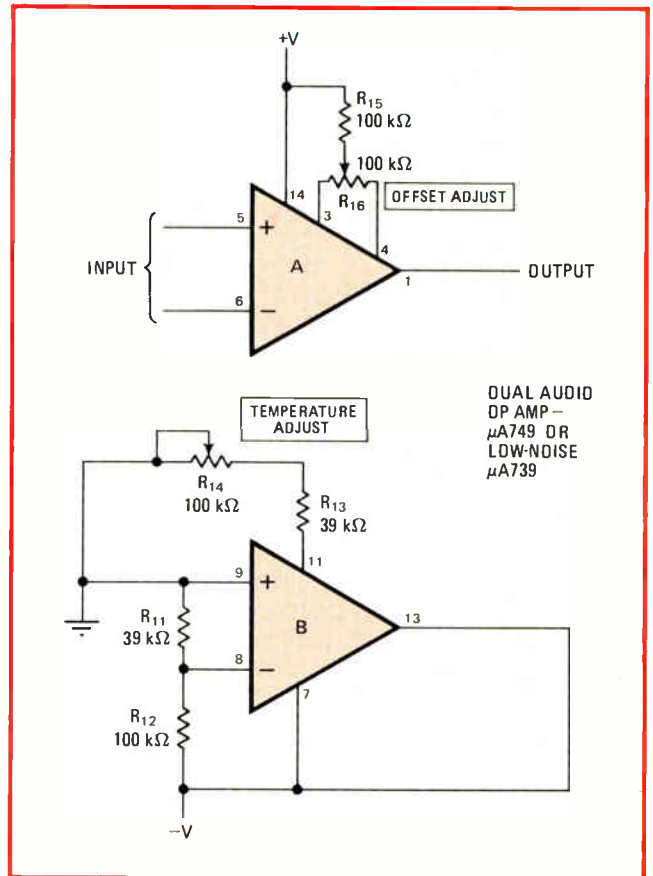

**2. B regulates A.** Using op amp B as a chip-heating system reduces thermal coefficient of op amp A to less than 6  $\mu V/^\circ C$ . Trimming offset voltage by adjusting  $R_{16}$  can cut drift to 1.5  $\mu V/^\circ C$ .  $R_{14}$  adjusts chip temperature; set it to produce 1.6 V between pins 12 and 14.

$R_{14}$  is adjusted so that 1.6 v appears between pins 14 (positive supply) and pin 12, the companion op amp will exhibit its rated thermal coefficient over a range of about  $\pm 25^\circ\text{C}$  around the ambient.

Potentiometer  $R_{16}$  is the offset adjust for the stabilized op amp. Setting this to produce a minimum offset voltage at the output (pin 1) will trim the thermal drift of op amp A to about  $1.5 \mu\text{V}/^\circ\text{C}$ . □

## Logic tester has unambiguous display

by S. Jayasimha Prasad and M. R. Muralidharan  
India Institute of Technology, Madras, India

It usually takes a little time to interpret the display of most logic probes. But this tester flashes a totally unambiguous 0 or 1 or ? on its seven-segment display, the question mark indicating any voltage level not within the logic thresholds.

The circuit, built around transistor-transistor logic NAND gates, is shown in the figure. The output character display is controlled by the logic of input transistors  $Q_1$

and  $Q_2$ . If an input of less than 0.8 v is encountered, both transistors are off and the display is gated to indicate a 0. For an input greater than 2.0 v, both transistors are on, and the display indicates a 1.

For an input that lies between 0.8 v and 2.0 v,  $Q_1$  is on while  $Q_2$  is off, and the NAND gating causes a question mark to be indicated on the display. A high impedance at the input registers a similar output.

The logic thresholds, being set by the voltage drops of the transistors, can be tailored to suit other needs. Transistors  $Q_3$ - $Q_5$ , which determine the logic-1 threshold, may be replaced with an appropriate number of diodes, and diodes may even be added in the base circuit of  $Q_1$  to raise the logic-0 threshold.

Resistors  $R_1$  and  $R_2$  limit the input current, and  $R_3$ - $R_7$  limit the currents to the display, which may be any low-power seven-segment light-emitting-diode unit. □

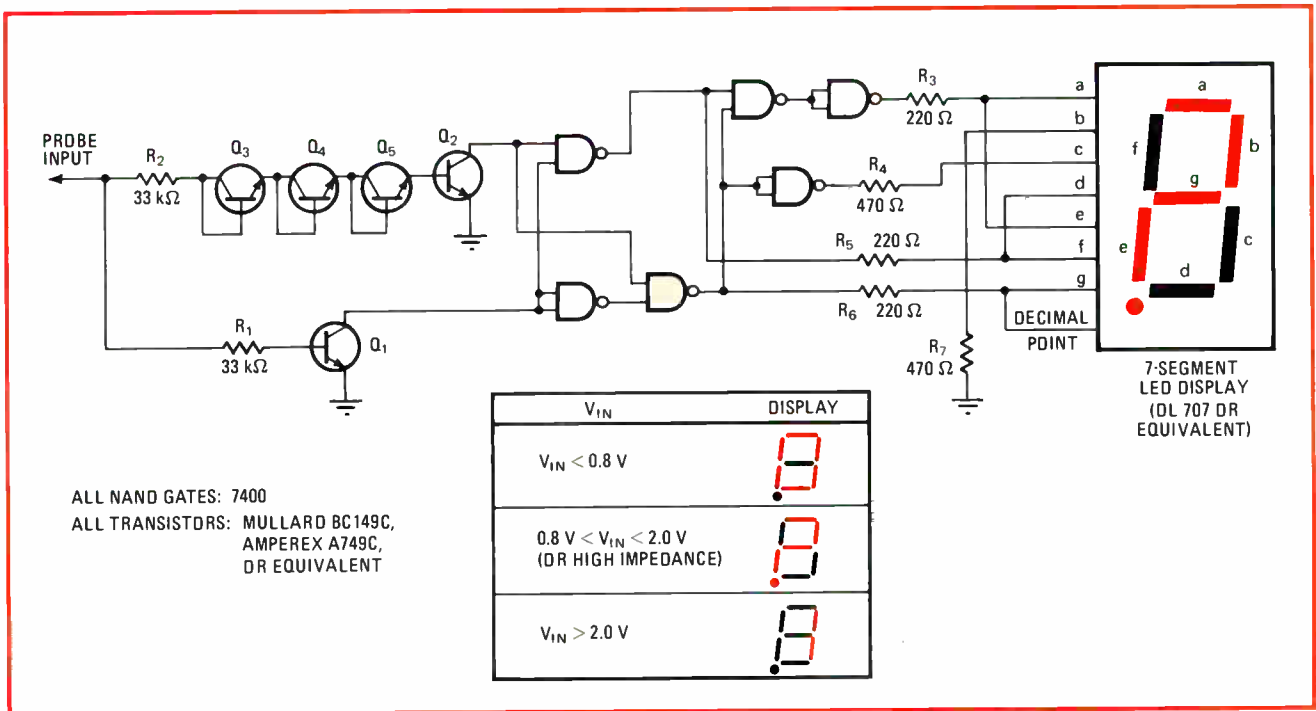

**Unquestionably logical.** TTL tester displays 0 for low level, 1 for high level, and ? for an open circuit or illogical level, as shown in table. Thresholds are set by transistors in the input circuit and may be changed to suit particular needs.

## Chart aids selection of optimum LED driver

by William A. Palm  
Minnetonka, Minn.

There is no single best way to drive a light-emitting diode from a transistor-transistor-logic output. Fanouts, polarities, and circuit loading must all be considered in choosing a drive configuration. The table lists eight different arrangements along with their respective characteristics and tradeoffs.

In methods 1, 2, and 3, the TTL outputs drive the LEDs directly and because of fanout limitations cannot drive



S-D's new dual channel  $\pm 18\text{v}$  pulse generator

# THE LOGICAL CHOICE

Attention all of you working with 2 and 4-phase logic systems, bipolar logic, radar testing and simulation, and with complex waveforms of all types: the new S-D 110D dual-channel pulse generator is for you.

In one compact instrument, Model 110D contains two complete pulse generators with all pulse parameters separately controllable for each channel. You can also *mix* the channels to produce complex waveforms and *delay* one channel from another.

That's why you can produce a true 2-phase system (4-phase with two slaved 110D's) as well as double and triple pulse pairs and controllable pulse trains for data simulation. For

sheer variety of pulses, nothing today touches Model 110D.

Model 110D is the latest member of a growing family of S-D pulse generators whose distinguished ancestors — Data-pulse Models 110B, 110A, and

110—set the industry standards in their time.

**Key 110D data:**  
Amplitude,  $\pm 18\text{v}$   
into 50 ohms • DC

offset to  $\pm 18\text{v}$  • rise/fall time variable from 5 ns to 500 millisecc • repetition rate 50 MHz • Price \$2,250 (U.S. only). Get the facts on the first modern-day

2-channel pulser.

Contact Scientific Devices or Systron-Donner at 10 Systron Drive, Concord, California 94518, Phone (415) 676-5000.

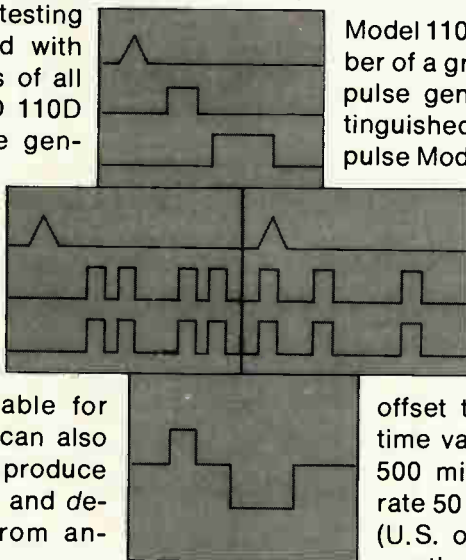

SYSTRON  DONNER

any other inputs. The remaining five arrangements employ drive transistors to avoid loading the outputs. When both pnp and npn transistors are readily available, method 4 may be used to light the LED with a logic 1 output, while method 8 indicates a logic 0. If it is desirable to have a single driving scheme, then inverters can be added to indicate both logic levels.

Need for low power consumption rules out methods 6

and 7, since they consume more power with the LED off than on. The on current in method 1 depends greatly on the chip's internal pull-up resistor. Logic levels other than TTL must be handled differently and are not considered in the table. □

Engineer's notebook is a regular feature in *Electronics*. We invite readers to submit original design shortcuts, calculation aids, measurement and test techniques, and other ideas for saving engineering time or cost. We'll pay \$50 for each item published.

### EIGHT METHODS OF DRIVING LEDs FROM TTL OUTPUTS

Method	Output that turns on LED	Circuit loading		Comments	
		Output high	Output low		
1		high	$I \approx (5 - 1.7)/R$	negligible	<ul style="list-style-type: none"> <li>Do not use output to drive logic inputs</li> </ul>
2		high	negligible	$I = 5/R$	<ul style="list-style-type: none"> <li>Do not use output to drive logic inputs</li> <li>Use open-collector outputs only</li> <li>Consumes power when LED is off</li> </ul>
3		low	negligible	$I \approx (5 - 1.7)/R$	<ul style="list-style-type: none"> <li>Do not use output to drive logic inputs</li> <li>Can use open collector or active output</li> </ul>
4		high	negligible	negligible	<ul style="list-style-type: none"> <li>Use active output only</li> </ul>
5		high	negligible	negligible	<ul style="list-style-type: none"> <li>Use active output only</li> </ul>
6		low	negligible	negligible for $R_s > 5 \text{ k}\Omega$	<ul style="list-style-type: none"> <li>Consumes power when LED is off</li> <li>Use active output only</li> </ul>
7		high	negligible	negligible	<ul style="list-style-type: none"> <li>Consumes power when LED is off</li> <li>Can use open collector or active output</li> </ul>
8		low	negligible	negligible	<ul style="list-style-type: none"> <li>Can use open collector or active output</li> </ul>

Use R = 200 Ω OR 300 Ω

## **UV-erasable read-only memories to drop in price**

If you've been shying away from the ultraviolet-light-erasable programmable ROMs because they're so expensive, you can look forward to a sharp decrease in unit price. Several new suppliers are jumping into the market, and higher-density (16,384-bit) devices are coming out. The chip in big demand at present is the Intel 8,192-bit 2708, which users we've spoken to say they are **now buying for \$50 to \$75 in small quantities. Watch for its price to drop at least in half** between July and December and make it even more popular for prototyping microprocessor-based systems.

## **Conductive foam clamps ringing on computer bus line**

Here's a fix for ringing on computer bus lines. It's not the cure you would ship with a product, but it will do a quick job on a breadboard, says John M. Harrison, Concord, N.H.

The problem was in 8-foot bus-extension cables that had been attached with no terminators to a microcomputer bus. Debugging of the system revealed that ringing was the cause of unreliable decoding. Since the system would eventually operate within the computer's mainframe, a permanent fix was not important. The solution was to **clamp a piece of conductive foam (the black type in which MOS integrated circuits are frequently supplied) around the flat cable**, using simply a large paper clamp. The spurious decoding was completely gone, says Harrison, and he could then continue to debug "real" problems.

## **4-k RAM has low standby power**

Memory-system designers who want to keep standby power as low as possible—for battery backup, for example—should look at the new 16-pin 4,096-bit dynamic random-access memory now being supplied in sample form by Mostek Corp., Carrollton, Texas. The new MK4227 **slashes standby current to 100 milliamperes and standby power dissipation to a mere 1.3 milliwatts**, compared to the 27 mw for the firm's popular high-performance 4-k dynamic RAM, the 4027. The essential difference between the two chips concerns the row-address strobe—the 4027 has a TTL-to-MOS level converter on the strobe, while the 4227 does not and instead has to use a high-level clock. Actually, early 18- and 22-pin 4-k RAMs needed the very same high-level clock, and Mostek hopes to convert users of those devices, too. Access time for the 4227 is the same as that for the 4027—150, 200, or 250 nanoseconds.

## **Postscripts**

If you're looking to play a role in the exploding world of telecommunications, you'll be interested in a recent report from the Science and Technology Telecommunications Task Force of the U.S. Department of Commerce. Based on review of more than 100 publications, consultations with 17 industrial firms, and visits to 39 other companies, the report attempts to identify Government and industry actions that will help apply new technologies. Send \$3.25 to the U. S. Government Printing Office, Washington, D.C. 20420, and ask for OT Special Publication 76-9, "Lowering Barriers to Telecommunications Growth," Douglass D. Crombie, editor. . . . With the increasingly crowded spectrum, you may also be interested in a new series of RFI-EMI-EMC seminars run by Don White Consultants Inc., 14800 Springfield Road, Germantown, Md. 20767 (301) 948-0028. There's a catalog that includes a complete course description and calendar.

**Stephen E. Scrupski**

# Borrow my coffee cup... but never my C-Meter.

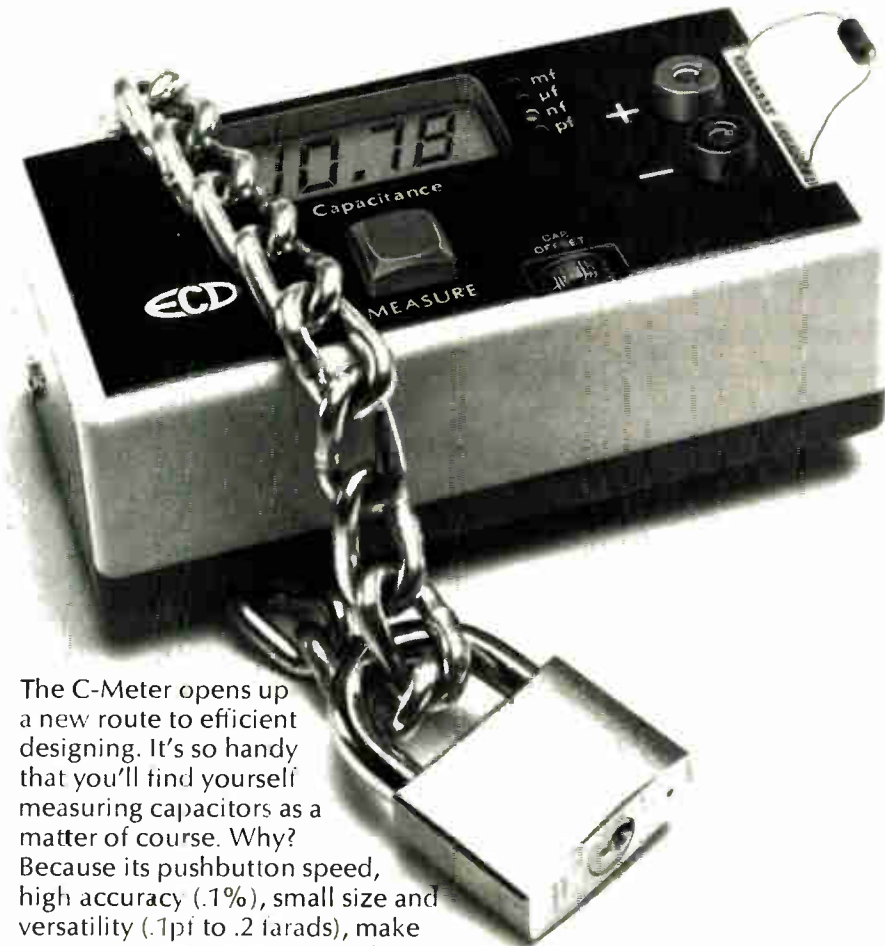

The C-Meter opens up a new route to efficient designing. It's so handy that you'll find yourself measuring capacitors as a matter of course. Why?

Because its pushbutton speed, high accuracy (.1%), small size and versatility (.1pf to .2 farads), make capacitors easier to measure than resistors.

With the C-Meter, you'll waste no time twiddling, and nulling, and you'll cut the need for expensive tight-tolerance capacitors or tweak pots in your circuits. You'll be a much more efficient engineer. And popular too, because people just can't keep their hands off the C-Meter.

You owe it to yourself to try one. Our reps are stocking them at **\$289.**



**ECD CORP.**

193 BROADWAY, CAMBRIDGE, MASS. 02139  
(617) 661-4400

SALES OFFICES: AL, Huntsville (205) 533-5896; AZ, Scottsdale (602) 947-7341; CA, Costa Mesa (714) 540-7160; CA, Sunnyvale (408) 733-8690; CO, Denver (303) 750-1222; FL, Winter Haven (813) 294-5815; GA, Chamblee (404) 457-7117; IL, Elk Grove Vill (312) 593-0282; IN, Indianapolis (317) 293-9827; MD, Silver Spring (301) 622-4200; MA, Burlington (617) 273-0198; MN, Minneapolis (612) 781-1611; NJ, Camden (215) 925-8711; NM, Albuquerque (505) 299-7658; NY, Great Neck (516) 482-3500, (212) 895-7177, Syracuse (315) 446-0220; NC, Raleigh (919) 787-5818; OH, Centerville (513) 433-8171; TX, Houston (713) 688-9971; TX, Richardson (214) 231-2573.

Circle 121 on reader service card

# 4-k static RAM uses dynamic features

Mostek device boasts 200-ns maximum access time, 340-ns cycle time with low power requirements and no external refresh circuitry

by Larry Armstrong, Midwest bureau manager

Of the many 4,096-bit static random-access memories to be introduced in the coming months, Mostek's promises to be a little different. By borrowing features of dynamic RAMs, the Carrollton, Texas, MOS house has reduced the chip size and eliminated the high power requirements of fully static memories without requiring the external refresh circuitry and multiple power supplies of dynamics.

The MK4104, organized as 4,096 by 1 bit, is the first of the firm's 4-k statics to reach the market. Mostek says it has a better speed-power product than known competitors. Maximum access time is 200 nanoseconds, and read or write cycle time is 340 ns. Power consumption depends on the frequency: at 4 megahertz, active power is typically 80 milliwatts and standby power is 8 mw, but at 1 MHz, power dissipation drops to 35 mw.

The 4104's memory array is static, but it is controlled by a clocked interface that allows the use of a dynamic differential sense amplifier that reduces cell size and improves speed. "The user will have to generate a negative-going edge to enable the chip," concedes Derrell Coker, memory-applications manager. "But most systems that this part will go into will already have a clock, such as any microprocessor-based system. If not, the speed-power benefit will outweigh the cost of an external clock by tenfold." A 16,384-by-8-bit memory system made of 4104s, for example, would dissipate less than 3 watts, he points out. Power-supply and cooling costs are \$1 to \$1.50 per watt, he says.

Besides the already low "automat-

ic" standby power dissipation—effective whenever the chip is deselected—the 4104 has another low-power mode. Lowering the part's single 5-volt supply to 2 v cuts power drain to 0.8 mw.

Mostek has kept the chip size to about 24,000 square mils, small for a static RAM. Although the device is based on a six-element cell, active transistor pull-ups have been replaced by a pair of passive polysilicon resistors. That change pares cell size to 2.75 mil<sup>2</sup>, compared with the conventional 5-mil<sup>2</sup> static-memory cell. Output data is valid as long as the chip is enabled, and if its early-

write mode is used for all write operations, the data-input pin can be tied to the pc board's data-output pin without additional circuitry.

Mostek plans to start shipping samples in May of the 4,096-by-1-bit MK4451 with common I/O capability. Samples of the 1,024-by-4-bit MK4404 will be available next month.

The MK4104P-3 will go into production this month in the industry standard 18-pin ceramic package. The price in quantities of 100 or more will be \$18.75 each.

Mostek Corp., 1215 W. Crosby Road, Carrollton, Texas 75006 [338]

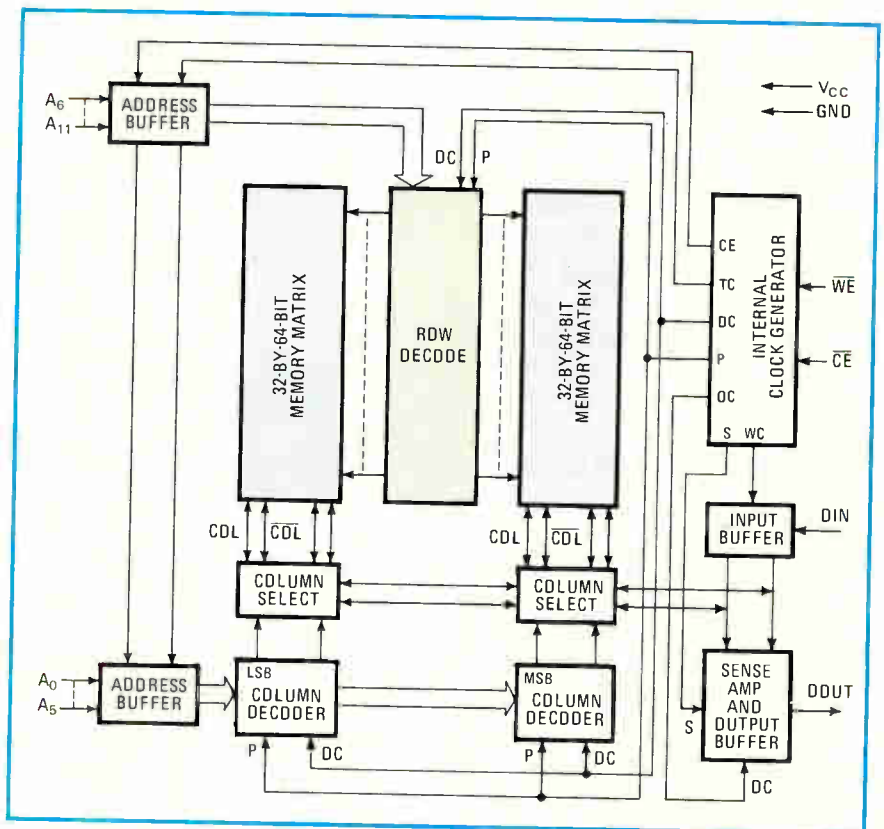



**30 Day Delivery.  
A Complete Line That's REAL.  
Extensive Software.  
Full Nomenclature.  
7 Years of Proven Reliability.**

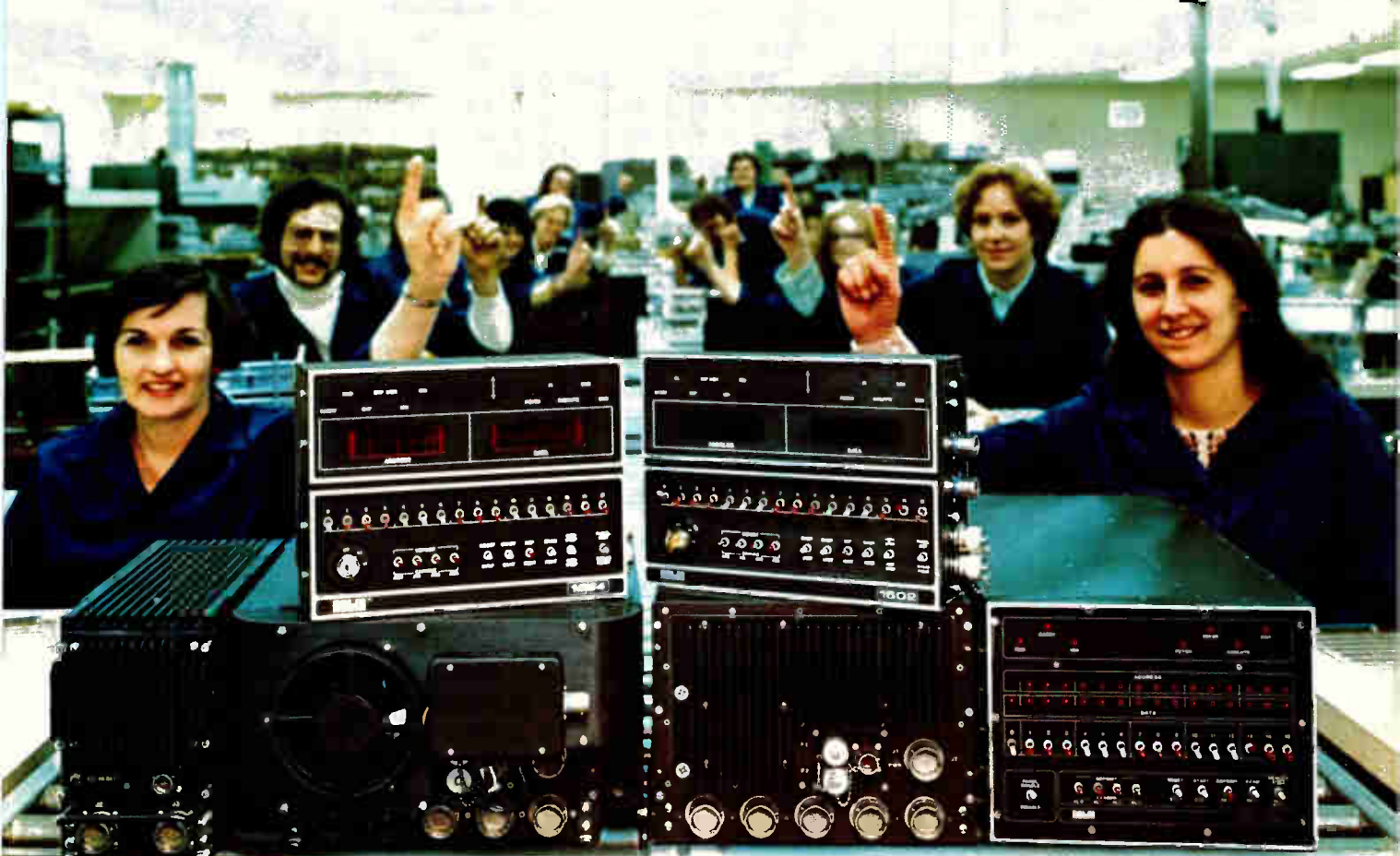

**That's Why We're #1  
in Mil-Spec Computers.**

**ROLM**  
CORPORATION

4900 Old Ironsides Drive, Santa Clara, CA 95050. (408) 988-2900.  
In Europe: 645 Hanau, Muehlstrasse 19, Germany, 06181 15011, TWX 418-4170.

Circle 125 on reader service card

# Since reliability is required here...



## ...you start here.

Look inside today's innovative electronic products. You'll find the critical components are large-scale integration — integrated circuits (LSI-IC's). Take the TEKTRONIX 4051 Graphic System shown above. It's control, memory, and communication with peripherals depend on the reliable performance of LSI-IC's. That's why more resources are being dedicated to IC selection and testing than ever before.



At Tektronix, new product designers team up with specialists in IC technology and testing known as Component Evaluation Engineers. Using their combined expertise, the team compiles information on the devices that seem to fit the application and then narrow the list to a few good candidates. Now, Component Evaluation Engineers begin their most important function; thoroughly evaluating the performance and reliability of each candidate device.

The evaluation process begins by investigating those device parameters and functions most critical to the intended application. This sometimes leads to a complete device characterization, a process that requires exhaustive testing.

When an IC is characterized, every measurable parameter and function is tested, actual limits of performance are determined, and then device behaviour is documented for all the various sets of input conditions in all their combinations and permutations. That's a lot of testing and it can quickly build mountains of test data. A system that performs accurate and reliable tests is not enough. The Component Evaluation Engineer must also have the tools to reduce the data mass into a usable form. For device characterization, the engineer needs a combination general purpose IC test system and a data processing system—a totally integrated package that both acquires and processes test and measurement data.

Tektronix Component Evaluation Engineers find all the qualities described above in a TEKTRONIX S-3260 Automated IC Test System. These systems are used for device characterization, field failure analysis, IC process evaluation, and incoming inspection.

Tektronix LSI-IC test systems are used by the world's leading communications companies, aerospace contractors, computer manufacturers, semiconductor manufacturers, and by the military. Serious about reliability? Then you should know about Tektronix IC test systems. Write Tektronix, Inc., P.O. Box 500, Beaverton, OR 97077. In Europe write Tektronix Limited, P.O. Box 36, St. Peters Port, Guernsey, Channel Islands.

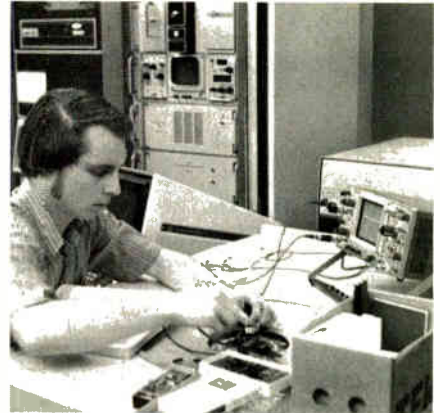

Serious about reliability?  
Then you need to know about  
Tektronix IC Test Systems.

**Tektronix**  
COMMITTED TO EXCELLENCE

For Technical Data circle 126 on Reader Service Card  
For Demonstration circle 127 on Reader Service Card

# Recorders get facelift, C-MOS logic

Leeds & Northrup's redesigned Speedomax machines also replace inkpad-and-wheel printers with thermal type and feature digital readouts

by Raymond P. Capece, Industrial Electronics Editor

An old favorite in the industrial recorder market, Leeds & Northrup's Speedomax line is getting a facelift as well as updated multipoint recorder units. A new thermal printing system eliminates the mess and maintenance of inkpad-and-wheel printers, and a new large digital readout that can be read from several feet away indicates the point number being logged. But the big change is inside: utilization of complementary-MOS logic circuits with their high noise immunity and low power drain.

"We've replaced the complex cam-and-gear system required for synchronization between the pens and point numbers with C-MOS logic that makes the recorder inherently synchronous," explains Ralph Hartman, product applications specialist. The logic system is also more flexible. A programming board behind the front panel lets the user select the frequency of the printing of the point number next to its plot or permits him to skip channels with no pause required for the skipped point. Other switches log on alarm only, permit manual advance of point-number cycling, select holding on a single point, and give indication without printing.

The new machines' names—the 165 and the 250—indicate their chart width in millimeters. The capacities of the new series are 25% greater than earlier models and most other recorders. Up to 30 points can be accommodated on the Speedomax 250, as opposed to 24, and up to 15 points on the Speedomax 165, rather than 12 on other recorders with comparable chart widths. This higher density is made possible by the

more flexible point-number identification, which can be set on the programming board anywhere from once every dot to once every 99 dots.

A wide range of options is available on the digitally controlled recorders. The 250 is available with as many as five chart-drive speeds, from 1 to 60 inches per hour, while the 165 is available with as many as four speeds. Individual synchronous motors are supplied for each speed.

Another user option is a time-marking feature that prints the correct hourly time on the left-hand margin of the chart paper independent of chart speed. In addition, a fail-safe option prints points in the right-hand margin. "Our customers find this feature most desirable," Hartman says. "If a thermocouple is open-circuited, the point is clearly printed offscale, rather than somewhere on the chart. The user then

knows immediately that a sensor has failed."

The recorders, designed for tough environments, are housed in gasketed, cast-aluminum enclosures and feature such refinements as an easily removable door panel and an overhang lip to keep dust from falling in when the door is opened. They operate from 120, 220, or 240 volts ac and, through interchangeable circuit-board cards, accept a wide range of inputs. Delivery time is eight weeks.

The Speedomax ink recorders will continue in production, but the firm thinks the price differential of a few hundred dollars for the new models—pegging the low end at just under \$1,000—will seem insignificant in view of the added flexibility of the 165 and the 250.

Leeds & Northrup Co., Sumneytown Pike, North Wales, Pa. 19454. Phone (215) 643-2000 [339]

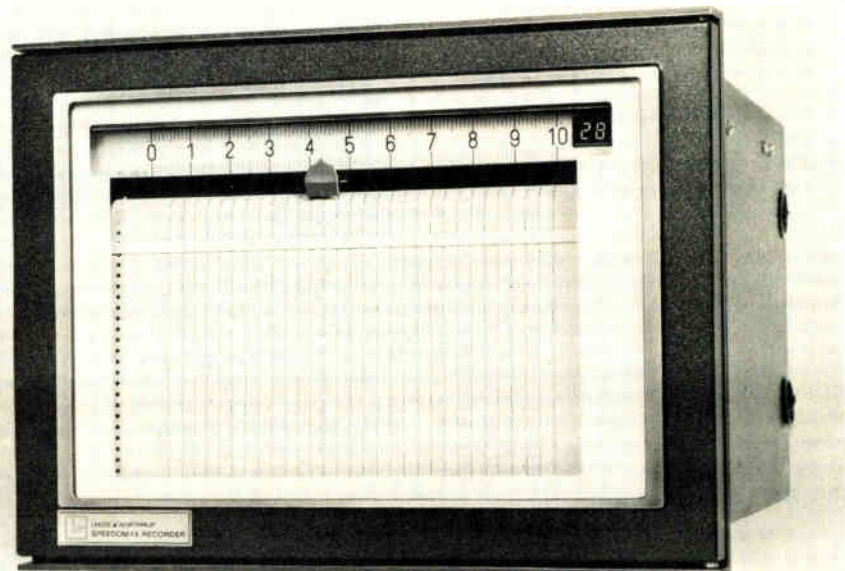

# CAN THE LEADER IN DIGITAL VOLTMETERS TAKE OVER IN COUNTERS?

Well...

We've seen some surprising changes. Last time we checked, for instance, we were sitting in the number two spot.\* Not too bad for a company that didn't begin building counters until 1973.

But, then again, we had an advantage. We knew what to do. We knew what it would take to be a leader in counters.

Give the guy on the bench, or building a system, a top-performing, Fluke-quality counter at a price a few hundred bucks less than he expected to pay. An honest bargain is always a big seller.



Counters!

But you can see. Take a look at the unit pictured in this ad—you're going to see a lot more on the front panel.

And there are options. Time base options. Frequency extension options. System interface options. We're going to have to send you information for you to get a complete idea of what this counter can do.

But it all starts with the \$995 unit.

An honest bargain from Fluke.

And, meanwhile, when someone asks

if we're going to take over in counters, we just smile, shrug and keep on building those great Fluke counters.

After all, we've only been at it 3 years.

	Time Base Options	
	TCXO	Oven-Stabilized
Frequency:	10.00 MHz	10.00 MHz
Aging Rate: (constant temperature)	$<\pm 3 \times 10^{-7}/\text{mo.}$	$<\pm 1 \times 10^{-7}/\text{mo.}$
Temperature Stability:		
20°C-30°C	$\pm 2 \times 10^{-7}$ typ.	$\pm 3 \times 10^{-9}$ typ.
0°C-50°C	$<\pm 5 \times 10^{-7}$	$<\pm 1 \times 10^{-8}$
Line Voltage: ( $\pm 10\%$ change)	$<\pm 5 \times 10^{-8}$	$<\pm 3 \times 10^{-9}$

We know time.

For data out today, dial our toll-free hotline, 800-426-0361.

John Fluke Mfg. Co., Inc., P.O. Box 43210, Mountlake Terrace, WA 98043

Fluke (Nederland) B.V., P.O. Box 5053, Zevenheuvelenweg 53, Tilburg, Netherlands.

Phone: (013) 673-973 Telex: 52237

\*Source available upon request.

\*\*U.S. price only.

Frequency Extension Options
520 MHz Prescaler Covers frequency range of 50 to 520 MHz, using a scaling ratio of 4. Sensitivity is 15 mV rms (AGC). Maximum allowable input is 5 V rms (fuse protected). VSWR less than 2:1 into 50 ohms for levels less than 1 V rms.
1000 MHz Prescaler Covers 50 to 1000 MHz using a scaling ratio of 8. Sensitivity is 15 mV rms, and maximum allowable input is 5 V rms (fuse protected). VSWR less than 2.5:1 50 ohms for levels less than 1 V rms.
1250 MHz Prescaler Covers 50 to 1250 MHz using a scaling ratio of 8. Sensitivity is 20 mV to 1000 MHz, increasing to 40 mV rms at 1250 MHz. Maximum input 5 V rms (fuse protected), and VSWR less than 2.5:1 for levels less than 1 V rms.

We know frequency.

For example, a bench/systems box at \$995\*\* with the same programming potential of counters selling \$130 to \$305 and even \$640 more.

That \$995 bargain is our 1953A Programmable Universal Counter/Timer. What does \$995 buy? Here's a good example of how we're changing the counter market. The 1953A is designed for both bench and systems use in frequency, ratio, period(s), time interval and gateable totals measurement. The basic box has a frequency range from DC to 125 MHz at sensitivities to 30 mV. Nine-digit LED display. Full triggering control.



THE SURPRISING NEWCOMER. 1953A COUNTER. **FLUKE**®

Circle 205 for demonstration, circle 129 for literature

World Radio History

Bypass the middleman!

Save more than 55%  
with unsurpassed quality  
and performance!

Delivery from stock!



# Deltron Slashes the Price of Processor Power Supplies

MPS-1: \$77

MPS-2: \$88

In any quantity!

Full one year  
guarantee.  
Designed for U.L.



MPS-1

Automatic  
overload and  
adjustable  
overvoltage  
protection. Dual  
input voltage.  
0.1% regulation.  
1.5 mV ripple  
and noise.



MPS-2

The MPS-1 or  
MPS-2 powers  
virtually any  
Microprocessor  
available. For that  
rare exception,  
talk to us about  
a custom unit.

MODEL	VOLTS	AMPS			PRICE ANY QUANTITY
		40°C	50°C	60°C	
MPS-1 7 x 4% ± 2%	5 - 5% Adj.	3.0	2.5	2.0	\$77
	12 - 5% Adj.	0.6	0.5	0.4	
	9 to 12V Adj.	0.6	0.5	0.4	
	or 5V	0.38	0.38	0.38	
MPS-2 9 x 4% ± 2%	5 - 5% Adj.	7.0	6.0	5.0	\$88
	12 - 5% Adj.	1.0	0.9	0.8	
	9V	1.2	1.1	1.0	
	or 5V	0.75	0.65	0.55	

Why buy brand A?  
Deltron's got them  
spec. for spec.  
at half the price.

Next time get the best  
for a lot less...  
write or call collect to:

**Deltron inc.**

Wissahickon Avenue, North Wales, Pa. 19454  
215-699-9261, TWX 510-661-8061

## New products

Components

### Relays overcome big weaknesses

Designed for ac operation  
devices are immune to noise,  
don't trigger on false pulses

Solid-state relays for ac applications—even zero-crossing devices—still have two weak points. An inductive load, such as a motor or transformer, can fool the zero-crossing type into generating radio-frequency interference when it turns on, and line transients can falsely trigger any solid-state relay made to date. Theta-J Relays Inc. gets around both weaknesses with its TA1201Q line of quiet-switching units. They will initially be rated at 140 volts at 0.75 ampere, go to 2A very soon, and eventually reach the 10-A range.

Edward T. Rodriguez, chairman and technical director, maintains that the relays are totally immune to noise on the output and will not trigger on false pulses. "Using them is just like using a rheostat or potentiometer at turn-on," he says. "You get smooth switching with absolutely no noise."

Rodriguez says the biggest difference between the TA1201Q line and conventional zero-crossing relays is that Theta-J combines its photocell optical-coupling approach [*Electron-*

*ics*, Aug. 5, 1976, p. 120) with a tailored power transistor as the output switching device. "The power transistor has no snap action," he says, so that it cannot be falsely triggered by the current from an inductive load—a common problem, he says, even in zero-crossing relays that use triacs designed to fire at the sine wave's zero-crossing point in voltage. The triac is also what makes conventional solid-state ac relays susceptible to line transients, according to Rodriguez.

Because the devices are immune to false turn-on by any rapidly rising load voltages, they can safely switch load voltages at frequencies well above 1 kilohertz, compared with about 400 hertz for today's best devices implemented with triacs, he says. The combination of photocell and power transistor also assures switching in greater than 1 millisecond instead of about 1 microsecond for conventional units. This is further assurance that the relay can neither create nor respond to transients.

The TA1201Q series is expected to be used in logic-oriented applications requiring quiet switching, including telephone switch-gear to accommodate the ac ringing signal, in computer peripherals and point-of-sale terminals. The relays are packaged in a 16-pin power dual in-line package. Price for the 0.75-A device is \$9 each in quantities of 1,000, and delivery takes six to eight weeks.

Theta-J Relays Inc., One DeAngely Drive, Bedford, Mass. 01730. Phone (617) 275-2575 [341]

Tiny trimmer capacitor  
withstands 3,000 g of shock



An ultraminiature trimmer capacitor with a Teflon fused-film dielectric can be used in a variety of applications to frequencies beyond 5 gigahertz. The sliding portion of the capacitor is so light compared with the force required to move it that the unit can withstand more than 3,000 g of shock.

Two versions of the capacitor are offered. The CP2 covers the range from less than 0.1 picofarad to more



# Chemicals for a bold new world.

Optical waveguides. Thin film memory. Liquid crystal displays. Wherever today's breakthroughs are shaping tomorrow's world, you'll find EM Laboratories as a source for fine chemicals.

We manufacture chemicals for vacuum deposition, liquid crystal displays, fiber optics, crystal growth... dopants for electronics... that's just the start. And the R&D for tomorrow is bubbling in our labs.

Pure consistency in fine chemicals from EM Laboratories. Whatever you need to frame your future, we produce it. For a better world.

Pure Consistency...



**EM Laboratories, Inc.**

associate of  
**E. Merck, Darmstadt, Germany**  
500 Executive Boulevard  
Elmsford, N.Y. 10523  
(914) 592-4660

◆ Chemicals for electro optics ◆ Suprapur® ◆ Patinal®  
◆ Aneron® ◆ Licristal® ◆ Selectipur®

Circle 131 on reader service card

# THE FIRST \$5.00\* MICROPROCESSOR INTERFACE

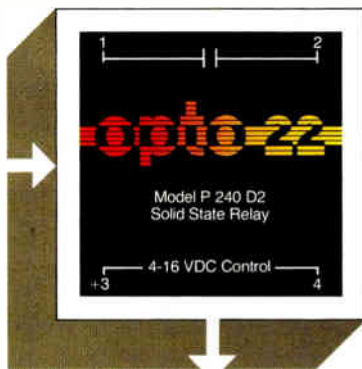
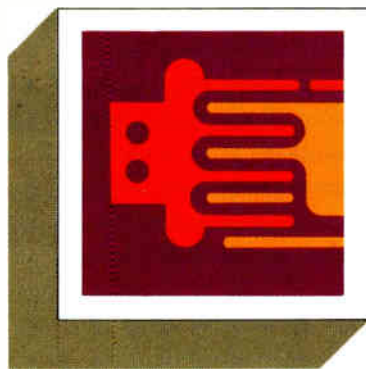

Photo-isolated, zero voltage switching. Solid State Relay for driving motors, solenoids, lamps, etc.

- 8-amp thyristor output
- T<sup>2</sup>L and CMOS compatible
- Built-in snubber
- UL and CSA Recognized

All the features you expect from Opto 22 Solid State Relays. Call our Distributor Division to place your order or request complete catalog at (714)892-7676 or (714)892-3313.

O.E.M. Production Quantities



## OPTO 22

5842 Research Drive  
Huntington Beach, California 92649

Circle 132 on reader service card

# HELP WANTED

While it is not our policy to encourage job hopping—quite the opposite, in fact—the headline above must have got your attention for a reason.

Perhaps you should turn to the back of this issue to our Classified Section. One of the job descriptions might fit you.

## New products

than 2.5 pF, while the corresponding numbers for the CP10 are 0.5 and 9.0 pF. The CP2 has a Q of 1,000 at 250 megahertz, while the Q of the CP10 is 500 at that frequency. Both units have a voltage rating of 150 volts dc, an insulation resistance of 50,000 megohms at 10 v, and an operating temperature range of -55°C to 125°C.

The capacitors are available on pre-aligned high-temperature tape, which can be used to hold them in place during soldering. They are also provided in assembled form, aligned and soldered to alumina substrates. These latter units can be handled as conventional chip devices, but the substrate adds approximately 0.3 pF to the minimum capacitance.

Voltronics Corp., West St., East Hanover, N.J. 07936 [343]

## Hybrid solid-state relay meets MIL-R-28750

Constructed like a hybrid integrated circuit and hermetically sealed in a metal dual in-line package, the

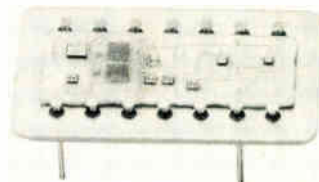

model 683-1 dc solid-state relay meets the requirements of MIL-R-28750. It operates over the range from -55°C to 115°C, generates no electromagnetic interference, and turns on and off very quickly—in at most 50 microseconds and 150 μs, respectively.

The relay employs a proprietary



# SEMICONDUCTOR FUSES.

Type, size, ratings, performance... they're all easy to find, because the Buss Fuse line is a complete line. The ordering's easy, too, with only one source to deal with: totally reliable Bussmann.

## BUSS® SEMICONDUCTOR FUSES: We've given them extremely low $I^2t$ and $I_p$ Let-thru values to give you excellent protection.

Buss FWP and FBP 700 volt Semiconductor Fuses give you the speed and current-limiting performance you need to protect diodes, SCR's and other semiconductors. And we have a brand new 12-page bulletin out with all the charts to prove it. Ask for your free copy (Bussmann Bulletin SCFP) so you can check us out.

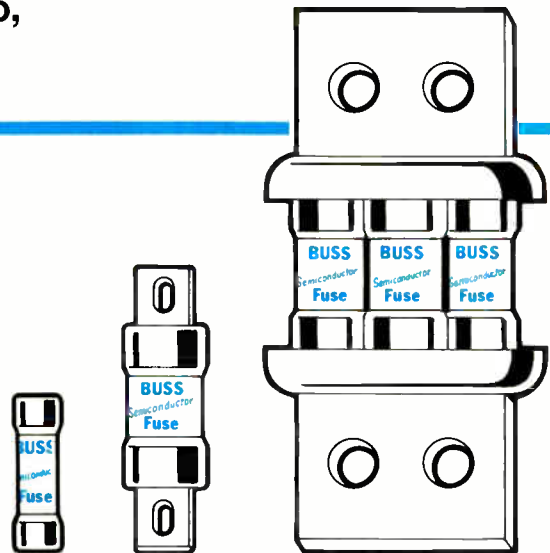

## TRON\* RECTIFIER FUSES, TOO.

There's also a complete line of TRON Rectifier Fuses... from 1/2 to 1,000 amperes, up to 600 volts. They're ideal for protecting all solid state devices and anywhere else extremely fast-opening, real-current-limiting/low-let-thru performance is needed. Ask us for this bulletin, too. (Bussmann Bulletin TRFS.)

\*A member of the TRON family of marks, Reg. U.S. Pat. Off.

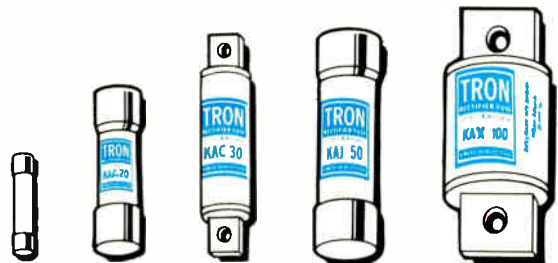

# EVERY KIND YOU NEED YOU CAN GET FROM US, EASY.

SUPPLIED THE ECONOMICAL WAY  
THRU DISTRIBUTORS  
**BUSS FUSES**  
THE QUALITY LINE



BUSSMANN MANUFACTURING  
a McGraw-Edison Company Division  
St. Louis, Missouri 63107



L,R,C  
goes  $\mu$ P

## Simple, fast, accurate

This all new microprocessor-controlled bridge is ideal for your manual or automatic component testing. Functions, ranges, test voltages and frequencies are easily selected on the 24-button front panel keyboard or can be programmed via the optional IEEE 488-1975 interface bus. Measurement speed is 100-200 ms for 1 kHz and 200-300 ms for 120 Hz.

For component sorting, optional plug-in PROM's enable you to set up to 10 programmable limits.



All for under \$5,000 U.S.A. (not including options).

- dual 4½-digit displays.
- 1 kHz and 120 Hz freq.
- wide ranges (C to 200,000  $\mu$ F).
- 0.1% basic accuracy.
- autoranging.
- selectable test voltages.
- 100-300 ms measurement speed.
- low cost options:
  - IEEE 488-1975 interface bus.
  - Single or multiple limits.

	Capacitance	Inductance	Resistance
1 kHz	200 pF to 20,000 $\mu$ F	20 $\mu$ H to 2000 H	200 m $\Omega$ to 20 M $\Omega$
120 Hz	2000 pF to 200,000 $\mu$ F	200 $\mu$ H to 20,000 H	

D range is 0.0001 to 1.9999. Q range is 0.5 to 10,000. Gp 200 S to 2000 nS.



Model 296  
Automatic L,R,C Digital Meter

Electro Scientific Industries  
13900 N.W. Science Park Dr.  
Portland, Oregon 97229  
Telephone: (503) 641-4141  
Telex: 36-0273



Circle 134 on reader service card

## New products

constant-current microcircuit for a TTL- and HINIL-compatible input control range of 3 to 15 v dc. Positive-feedback circuitry gives it a snap action that prevents damage from slowly ramped inputs. Priced at \$16.50 each in thousands, the relays have a delivery time of four to six weeks.

Teledyne Relays, 3155 W. El Segundo Blvd., Hawthorne, Calif. 90250. Phone (213) 973-4545 [344]

Long-lived, highly linear  
pots sell for only \$2.95

A line of semiprecision conductive-plastic potentiometers offers linearity within 1%, a rotational life of 5 million cycles, and a low-volume price of \$2.95. In lots of 10,000 pieces, the price drops to \$2.50 each.

The single-turn Econopot MKIII has precious-metal contacts, 303 stainless-steel shafts, and thermoset plastic terminal supports. In addition, of course, they provide the infinite resolution and the low noise characteristic of conductive plastic.

Delivery time for the MKIII is from stock to two weeks, depending upon the resistance required.

New England Instrument Co., Kendall Lane, Natick, Mass. 01760. Phone James Dyne at (617) 873-9711 [346]

3-ampere relay weighs  
less than 1/6 ounce

Although it measures only 0.4 inch high and weighs less than 1/6 ounce, a

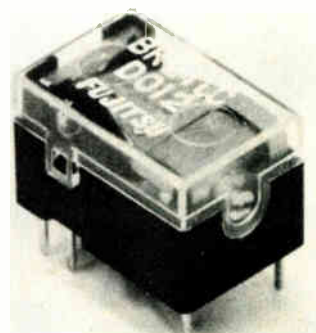

# HOPE

in a word is what we are.

Project HOPE exists because there are people with hope—people who have given 3.5 million men, women, and children on four continents the chance for happier, more productive lives through improved health care.

Give to

**PROJECT  
HOPE**

Department A  
Washington, D. C. 20007

# Guildline Introduces the only 14 Million Count DVM on the Market Today



Guildline's radical 7-1/2 digit precision digital voltmeter, Model 9577 features standards laboratory accuracy and stability. The 9577 is equally at home on the work bench or in a system application via programmable BCD or IEEE Standard 488.

#### FEATURES:

- Capability — DC volts, AC (rms) volts, ohms, and ratio
- 0.0004% DC accuracy • Resolution — 1  $\mu$ v on 10 volt range
- 20ppm per year stability
- Self-Check via front panel or system mode
- 500 readings per second
- > 1000G $\Omega$  input resistance • Digital Filtering



## Guildline Instruments, Inc.

1997 PALMER AVE., LARCHMONT, NEW YORK 10538 (914) 834-8100

# Move up..to our miniature.



**2 GHZ: Maximum VSWR: 1.3:1**  
**Insertion Loss: .3 dB**  
**Overall Accuracy: 2%**

We're very excited about introducing to you our newly designed miniature rotary attenuator. We've worked very hard to bring to you a new miniature that exceeds our standard rotary in every way. At high frequencies the specs are really impressive, at lower frequencies they're even better. And the price is unbelievable. We still bring to you 25 years of innovative engineering experience and superior quality. Very precise resistors and goldplated contacts maintain our high level of accuracy. And our unique self-cleaning switch action insures positive repeatability over a prolonged period of time. We feel so sure you will be impressed with our new miniature rotary that we have a large supply in stock. Write for more information, or better yet, call in your order for immediate delivery.

**AVAILABLE IN STOCK.**

**KAY Elemetrics Corp.**  
 12 Maple Avenue, Pine Brook, N.J. 07058  
 (201) 227-2000

Circle 136 on reader service card

## DIGITAL MULTIMETERS

**NLS proves NLS' DMMs have more capability at lower prices.**

*NLS' Silver Jubilee Year*

## THE VOLKSMETER FAMILY LM SERIES

**Features Include:**

- Super Rugged - Ideal for field service use.
- Battery powered with batteries and charger unit included.
- Exclusive NLS fuseless protection in kΩ mode - up to 500 vdc or rms ac may be applied without damage.
- Overload indication.
- Automatic zeroing and polarity.
- Operating temperature - 0° to 45°C.
- Large 0.3" LED display.
- Small size: 1.9" H x 2.7" W x 4.0" D.
- Six optional shunts for current measurement - LM-3.5 includes three shunts in values of 10 mA, 100 mA and 1A.



MODEL	RANGES	DC ACCURACY	RESOLUTION	DIGITS	PRICE
LM-3	VDC & VAC	±1% Rdg	1 mV	3	\$125
LM-3.5	1V, 10V, 100V & 1000V	±0.5% Rdg	1 mV	3-1/2	\$147
LM-40	OHMS	±0.1% Rdg	100 μV	4	\$190
LM-4	1 kΩ, 10 kΩ, 100 kΩ, 1 MΩ & 10 MΩ	±0.03% Rdg	100 μV	4	\$227



**Non-Linear Systems, Inc.**

*Originator of the digital voltmeter.*

Box N, Del Mar, California 92014 Telephone (714) 755-1134

See your local distributor!

Distributor inquiries invited.

136 Circle 206 on reader service card

## New products

new micro relay is available with contact ratings as high as 3 amperes dc and 24 volts dc. Intended for printed-circuit-board applications requiring high-density mounting, the single-pole double-throw relays have DIP terminals spaced on 0.1-in. centers and come with four contact variations. Their electrical life is more than half a million operations. The relays sell for \$1.08 each in thousands.

Impact Electrical Products Inc., 7 Westchester Plaza, Elmsford, N.Y. 10523. Phone Harry Hopper at (914) 592-2880 [347]

10-ounce lithium battery puts out 1 A for 30 hours

A lithium battery that weighs 10 ounces and is 5.5 inches long by 1.64 in. in diameter has a capacity of 30 ampere-hours at a drain of 1 ampere. With a nominal operating voltage of 2.8 v, the model 660-5A Eternacell has an energy density of 134 watt-hours per pound. Its shelf life is greater than five years, and it can operate at -65°F. It is available with a positive button terminal or positive and negative solder tabs. Pricing on the 660-5A is less than \$10 each in large quantities. Delivery is from stock to two weeks.

Power Conversion Inc., 70 MacQuesten Parkway South, Mt. Vernon, N.Y. 10550. Phone Stewart Chodosh at (914) 699-7333 [345]



Electronics/March 3, 1977

**WE WILL CUSTOM DESIGN AND  
PROTOTYPE YOUR CONNECTOR-  
AND CHANGES ARE THAT WE  
WILL NOT CHARGE TOOLING  
AND SAVE YOU MONEY IN  
PRODUCTION QUANTITIES**



**WRITE OR PHONE  
(212) 899-4422**

*For the sales representative nearest you,  
see our listings in Electronic directories.*

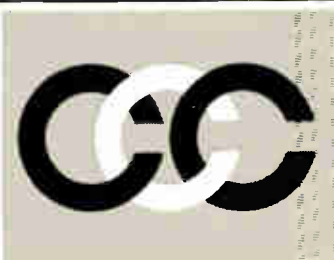

**CONTINENTAL  
CONNECTOR  
CORPORATION**

34-63 56th Street Woodside, N.Y. 11377

INTRODUCING **A NEW  
REVOLUTIONARY**

MULTI-DIGIT  
SOLID STATE READOUT

**BELOW \$1.**

PER DIGIT

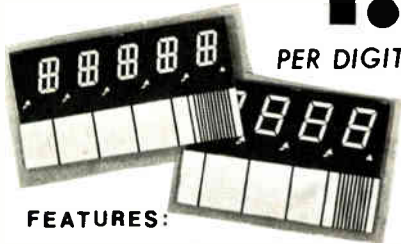

**FEATURES:**

- Non-fatiguing ELECTROLUMINESCENT light
- Space saving thin profile
- Wired for multiplexing
- Low a.c. power consumption
- Compatible with IC logic decoders and segment drivers
- Rugged, pluggable laminated plastic construction

**SPECIAL TRIAL OFFER**

ORDER FROM STOCK at **97¢** per digit, any of the following multi-digit readouts having 2 to 5 digits:  
 1/2" high with 9-segments  
 0.6" high with 7-segments  
 (minimum order--\$10.)



**T.L. ROBINSON CO., INC.**  
 P.O. BOX 0, EAST AURORA, N.Y. 14052  
 TEL. (716) 652-2111 TELEX: 91566

Circle 212 on reader service card

**Use Quick-Wedge to install a bus, connect a motor, mount a p.c. board, cinch up a connector**

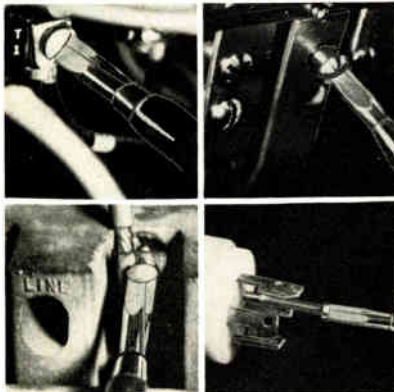

**They do all that ordinary screwdrivers do, PLUS they hold and start the screw**



**QUICK-WEDGE** 17 sizes

Screw-holding screwdrivers

**Unconditionally guaranteed.**

**BUY A SET TODAY**

See your dealer or write to:

**Kedman Company, P.O. Box 25667,  
 Salt Lake City, Utah 84125**

© Copyright 1977

**New products**

Materials

**Magnetic shield can be shaped**

Woven metal glass retains its magnetic permeability after rolling and stamping



The use of magnetic shielding is increasing as sales of electronic equipment rise, the trend toward miniaturization accelerates, and regulatory constraints tighten. But commonly used shielding creates handling headaches for manufacturers. Typical is Permalloy, which has a nominal magnetic permeability of 60,000 to 100,000 that can drop by as much as 50% when the material is wrapped in a cylindrical form. And annealing the material to restore its permeability is an expensive and time-consuming step.

Now, Allied Chemical has come along with Metshield, made of Metglas 2826, a soft-magnetic metal glass that boasts excellent stability during the handling and shaping operations. The material, which has a nominal composition of  $Fe_{40}Ni_{40}P_{14}B_6$ , permits a manufac-

turer to use simple fabrication methods to make its own shields.

The Metglas alloy is formed into 2-by-70-mil ribbons and crosswoven into 7-inch widths of a fabric called Metshield. It is then epoxy-coated, and the resulting fabric can be formed into complex shapes without altering performance.

Its nominal permeability is at least 60,000. In a laboratory test, the permeability of an unshaped strip of Metshield was measured; then it was rolled into a cylinder from which small strands were cut. The strands proved to have the same permeability as the original fabric.

The new material needs no high-temperature treatment for forming. Instead, the woven material can be cut to size with standard tools and fabricated to a particular shape with adhesives, thus reducing the time and cost of developing and testing designs. Performance can be tailored by using one or more layers. For example, the attenuation of a 60-hertz, 2-oersted field on a 2-in. diameter cylinder of this material can be varied from 20 decibels to 35 db by using one to four wraps.

Metshield weighs 1.2 pounds per square yard and is about 8 mils thick. It can be wrapped on a 1/4-in. mandrel. Its resistivity is 180 micro-ohms per centimeter, and its maximum use temperature is 100°C. Ultimate tensile strength is  $250 \times 10^3$  lb/in.<sup>2</sup>, or almost 10 times that of other shielding materials.

Other possible uses for the material or its derivatives are transformer laminations, shielded cable, and tape-recorder heads. In 7-in. widths and 10- to 25-foot lengths, the material costs \$14 per linear foot. In this quantity, delivery is off the shelf.

Allied Chemical Metglas Products, 7 Vreeland Road, Florham Park, N.J. 07932. (201) 455-4031 [371]

**Blue epoxy coating cures quickly under UV radiation**

A blue epoxy coating material, which can be used as a solder mask for hard printed-circuit boards or as

When you want modern, cost-efficient high vacuum pumping, you want Cryo-Torr® High Vacuum Pumps. No liquid nitrogen. No liquid nitrogen traps. And no process chamber contamination problems. Instead you get fast, clean, trouble-free, oil-free pumping of all gases in high vacuum systems — all the time.

Take our Cryo-Torr 7 High Vacuum Pump. It's the perfect replacement for conventional 6" oil diffusion or turbomolecular pumps. Not only does it eliminate liquid nitrogen consumption, but it saves on electrical power requirements — and, at the same time, delivers all

the performance dependability and fast pumping speeds you need.

Ideal for use in vacuum deposition equipment, sputtering systems, and ion implanters, Cryo-Torr High Vacuum Pumps get you out of the liquid nitrogen trap for good. Think of the money you'll save. For more information write or call CTI-Cryogenics, Kelvin Park, Waltham, Massachusetts 02154. Telephone: (617) 890-9400.

**CTI-CRYOGENICS**

# DON'T FALL INTO THE LIQUID NITROGEN TRAP.



**HELIX**  
A Helix Company

Circle 139 on reader service card

**65 watts, 10 MHz-2.5 GHz**



**New MCL power generators feature flexibility, high output, minimum distortion.**

Main frames for 115 VAC and for 208/220/240 VAC operation. Six standard front panel plug-ins provide frequency range from 10 MHz to 2500 MHz with a minimum output of 65 watts. Two optional plug-in modules are available which produce 100 watts narrow-banded.

Single knob tuning for each plug-in provides exact frequency selection. Front panel, direct frequency readout is accurate to  $\pm 1$  percent.

Solid-state mainframe designed for minimum components, optimum reliability. Residual AM held to .1 percent, eliminating nearly all AM distortion in output waveform. Generates continuous or 1 KHz square wave pulsed output. External AM signal generator can be added with single plug-in connection. External pulse circuit is TTL compatible. Automatic VSWR protection.

Write or call for your 4-page power generator brochure: Tom Rys, MCL, Inc., 10 N. Beach, LaGrange, IL 60525. (312) 354-4350.



Circle 140 on reader service card

**HELP WANTED**

While it is not our policy to encourage job hopping—quite the opposite, in fact—the headline above must have got your attention for a reason.

Perhaps you should turn to the back of this issue to our Classified Section. One of the job descriptions might fit you.

**New products**



a protective coating for flexible circuits, cures in seconds when exposed to ultraviolet radiation. Because it substitutes a short exposure to ultraviolet radiation for a prolonged heat treatment in an oven, the material is said to use as little as 10% of the energy required by conventional inks. It also eliminates racking and unranking steps, further reducing processing costs. Called ultraviolet cure epoxy 1301, the one-part material has a shelf life of one year.

3M Co., Dept. EP6-32, P.O. Box 33600, St. Paul, Minn. 55133 [373]

Solder preforms come with or without multicore flux

Solder preforms in virtually any size or shape are available in any soft solder alloy with or without multiple flux cores. The flux cores may be of type R (nonactivated), RMA (mildly activated), or RA (activated) rosin. Among the standard shapes are rings, washers, disks, rectangles, squares, pellets, and strips of tape





# TURNKEY 620 SYSTEMS FROM NEFF USING THE HP 9825 CALCULATOR.. the logical next step in data acquisition.

You're involved in a scientific, engineering, or industrial project that could use a high performance, low cost data acquisition system. But you know that system integration and software costs of most systems actually exceed the hardware. And your need is now, so you want a system that will take data immediately with minimum user training.

Our turnkey 620S was designed for you.....

620S is a sophisticated data acquisition system with amplifier-per-channel or differential multiplexer analog signal processing and using the H.P. 9825 computing calculator for system control, data analysis and recording.

Neff systems are known for high performance and the 620S is no exception. Consider 0.1% accuracy with 50kHz channel scanning rate, fullscale input sensitivities from 5 millivolts to 10 volts, up to 256 channels or 2048 channels fully expanded, and 120dB rejection of common mode voltages up to 300 volts. Selectable data filters, simultaneous sample and hold and input signal conditioning are but a few of the many available features.

The Hewlett-Packard 9825 calculator provides the 620S computer performance with the operating convenience of a calculator. Programming is simple with HPL, an easy to learn, high level language designed for scientists and engineers. Standard features include a live-keyboard, alpha numeric printer and cassette recorder. Up to 24K memory is available. Plug-in peripherals include floppy disk, line printer, x-y plotter, and tape punch. It also attaches to H.P. Interface Buss.

A complete, integrated data acquisition system that's easy to use — that's our turnkey 620S.

Like to know more? Call us today at 213-357-2281 or write for our free brochure.

**NEFF**  
INSTRUMENT CORPORATION

1088 E. Hamilton Rd., Duarte, Calif. 91010  
Tel. (213) 357-2281 TWX 910-585-1833



# Always in Stock...

International Rectifier's Silicon and SCR Rectifiers are Available in More Than 2,000 Possible Assemblies. Allied Will Make Up the Rectifiers to Your Order. We're Fully Stocked in All Six Stocking Locations.

## THESE ARE OUR CURRENT BEST MOVERS

Stock No.	Mfr's Type	Amp	PIV	Case	EACH
577-1183	IN1183	35	50	DO5	2.05
577-1184	IN1184	35	100	DO5	2.05
577-1186	IN1186	35	200	DO5	3.57
577-1190	IN1190	35	600	DO5	7.14
578-1186	IN1186A	40	200	DO5	3.68
578-1190	IN1190A	40	600	DO5	9.08
578-1200	IN1200B	12	100	DO4	2.38
578-1201	IN1201A	12	150	DO4	1.84
577-3209	IN3209	15	100	DO5	1.42
577-3212	IN3212	15	400	DO5	2.61
579-0688	2N688	16	400	TO48	7.45
579-0690	2N690	16	600	TO48	9.15
817-8280	16RC40A	16	400	TO48	8.80
817-8284	16RC60A	16	600	TO48	10.80
817-8285	16RC80A	16	800	TO48	15.40
817-8286	16RC100A	16	1000	TO48	20.10
817-8399	40HF10	40	100	DO5	2.05
817-8402	40HF30	40	300	DO5	3.83
817-8401	40HFR30	40	300	DO5	3.83
817-8403	40HF40	40	400	DO5	4.67
817-8405	40HF60	40	600	DO5	6.30
817-8406	40HFR60	40	600	DO5	6.30
817-8409	40HF100	40	1000	DO5	10.60
817-9050	70H10A	70	100	DO5	3.99
817-9055	70H20A	70	200	DO5	5.30
817-9065	70H30A	70	300	DO5	6.46
817-9066	70HR30A	70	300	DO5	6.46
817-9070	70H40A	70	400	DO5	7.61
817-9080	70H60A	70	600	DO5	9.98
817-9079	70HR60A	70	600	DO5	9.98
817-9081	70H100A	70	1000	DO5	15.54
817-9085	150K30A	150	300	DO8	21.53
817-9090	150KR30A	150	300	DO8	21.53
817-9095	150K60A	150	600	DO8	30.79
817-9100	150KR60A	150	600	DO8	30.79
817-9105	300U30A	300	300	DO9	27.83
817-9110	300UR30A	300	300	DO9	27.83
817-9115	300U60A	300	600	DO9	43.05
817-9120	300UR60A	300	600	DO9	43.05

Check out the almost endless number of possible assemblies available to you with our Silicon and SCR Rectifiers. See the tables below for specs. Make your selection of the different amps, voltages and cases you have to choose from and Allied will make up your order, no matter how big or how small.

### SILICON RECTIFIERS AVAILABLE

Amps	Volts	Case
12	200, 600, 1000	DO-4
16	200, 600, 1000	DO-4
40	200, 600, 1000	DO-5
60	200, 600	DO-5
70	200, 600, 1000	DO-5
150	400, 600, 800, 1000	DO-8
300	200, 400, 600, 1000, 1200, 1600	DO-9

### SILICON CONTROLLED RECTIFIERS AVAILABLE

Avg. Cur. Amp	PIV	Case
22.3	200, 400, 600, 1000	TO-48
50	200, 400, 600, 1000	TO-65
70	200, 600, 1000, 1200	TO-94
150	400, 600, 1000, 1200	TO-93
300	400, 800, 1000	TO-93

## 1/2 Price Sale! Warehouse Overstock

Stock No.	Mfr's Type	WAS EACH	NOW ONLY	Stock No.	Mfr's Type	WAS EACH	NOW ONLY
640-0755	IN755A	.80	.40	640-4001	IN4001	.32	.16
640-0756	IN756A	.80	.40	640-4004	IN4004	.46	.23
640-0759	IN759A	.80	.40	640-4006	IN4006	.46	.23
640-0962	IN962B	.80	.40	640-4007	IN4007	.48	.24
640-0963	IN963B	.80	.40	640-4738	IN4738A	.90	.45
640-0967	IN967B	.80	.40				

### Sale Ends, Friday, April 15, 1977

#### SIX STOCKING LOCATIONS TO SERVE YOUR NEEDS

12311 Industry Street, Garden Grove, California 92641, (714) 894-7581  
 1355 Sleepy Hollow Road, Elgin, Illinois 60120, (312) 697-8200  
 3180 Alfred Street, Santa Clara, California 95050, (408) 985-2323  
 3705 West Street, Landover, Maryland 20785, (301) 773-6556  
 845 Woburn Street, Wilmington, Massachusetts 01887, (617) 942-0150  
 401 East 8th Street, Fort Worth, Texas 76102, (817) 336-5401

Write to Fort Worth for Your FREE 1977 Engineering Manual and Purchasing Guide.

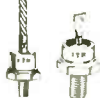

**ALLIED ELECTRONICS**  
 A DIVISION OF TANDY CORPORATION



Circle 142 on reader service card

## CAREER OPPORTUNITIES

Usually the best opportunity to grow in your field lies within your present company. You have made an investment in them. They have an investment in you.

But occasionally the best opportunity lies somewhere else. No one can decide but you.

Companies looking for good people run their recruitment ads in our Classified Section in the back of this magazine. Perhaps you'll find an opportunity there that's worth following up.

## New products

either cut to precise lengths or wound on reels as continuous ribbons.

Multicore Solders, Westbury, N.Y. 11590 [374]

### Rubber pyramid arrays

absorb microwaves

A flexible microwave absorber molded as an array of pyramids is useful at frequencies of 2.4 gigahertz and higher. Available in silicone rubber (Eccosorb RMP-S-75) or vinyl rubber (Eccosorb RMP-V-75), the absorber has a nominal reflectivity of -17 to -20 decibels. The silicone version, which is reinforced with fabric, is recommended for high-temperature, high-power, and airborne applications. The vinyl product, which is the more rugged, is useful for outdoor applications such as on ship masts and decks. The material can be bent easily and may be readily bonded in place. It can be cut with scissors or knife.

Sold as squares measuring 1 foot on a side, the absorbers are priced, in quantities of 51 to 100 square feet, at \$46.90 per square foot for the silicone material and \$33.10/ft<sup>2</sup> for the vinyl. Delivery is from stock.

Emerson & Cuming Inc., Canton, Mass. 02021 [376]

### Thick-film nickel paste

resists solder leaching

A conductive nickel paste formulation for thick-film hybrid circuits is readily soldered with tin-lead solders and is resistant to solder leaching. The paste, which can be screen-printed, adheres very well to alumina substrates when fired at 800°C to 900°C in nitrogen for 15 minutes. It is used in thick-film hybrids for low-cost metalization. The material sells for \$10 an ounce in small quantities and drops to \$7/oz for 100 oz and more.

Transene Co. Inc., Route 1, Rowley, Mass. 01969. Phone (617) 948-2501 or (617) 948-2811 [377]

# AO

If this is all you're seeing,

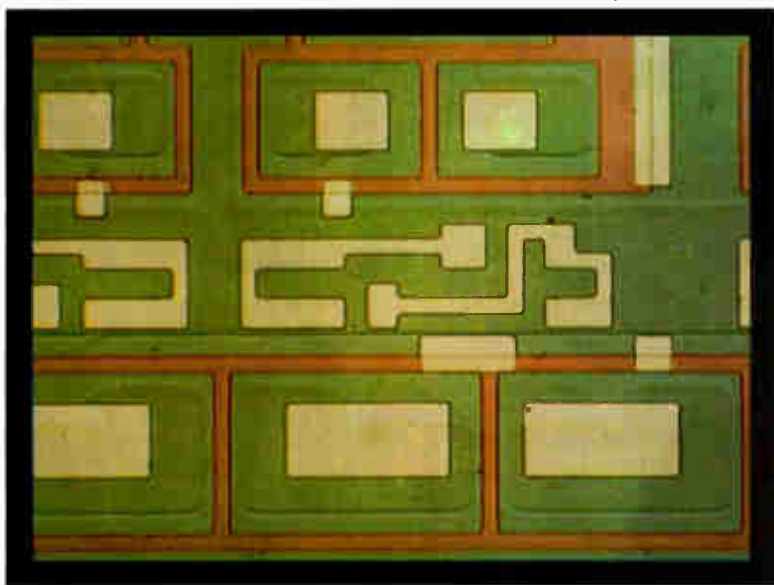

this is what you're missing

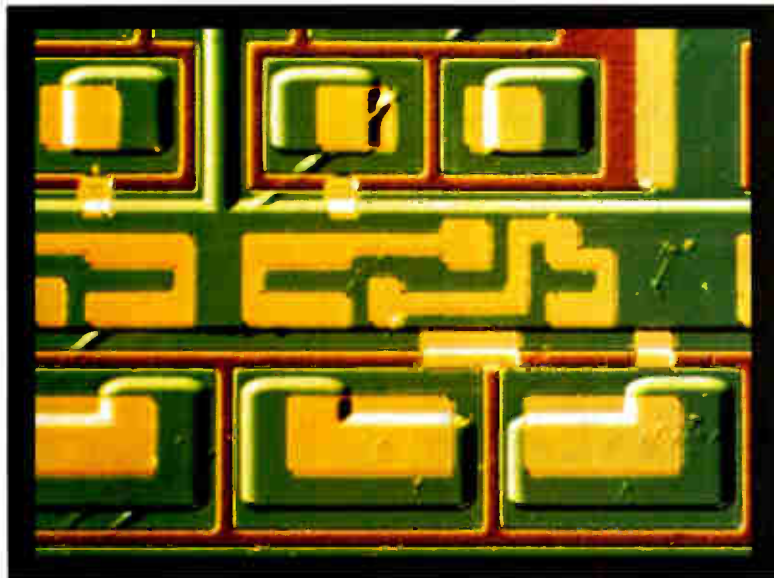

The AO® DICV Differential Interference Contrast Microscope makes the big difference.

With a standard brightfield microscope you see only what is shown in the top sample.

Now look at the bottom sample. The AO DICV Microscope can help you see surface irregularities, inclusions and faults long before final testing. Long before you have invested more production time and money in a circuit or component that is defective.

By using incident light, after Nomarski, the AO DICV Microscope reveals significant detail in outstanding relief through vivid contrast enhancement.

So, if missing detail is costing you money, you can't afford to overlook the AO DICV Microscope. For details or a demonstration see your AO Dealer or write American Optical, Scientific Instrument Division, Buffalo, NY 14215.



**AO**  
American  
Optical

# HITACHI IC MEMORIES

Speed's the thing with Hitachi IC memories. Check the chart.  
So is variety. Check the chart, again.  
So is quality. Check with us when you're thinking all three.

## 4K DYNAMIC

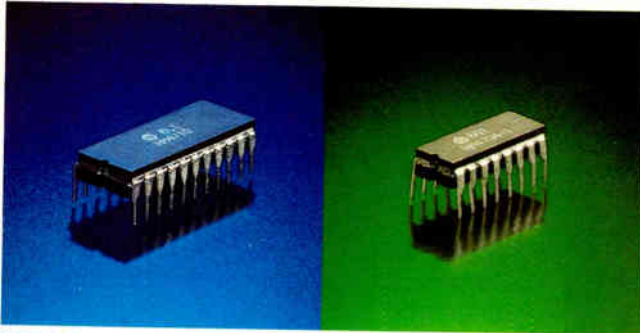

**HM4710**

High speed 22pin 4K Dynamic RAM  
Access Time  
ECL Output 100ns max HM4710  
TTL Output 130ns max HM4711-1

**HM4704-1**

High Speed 16pin 4K Dynamic RAM  
Access Time  
TTL Output 200ns max HM4704-1

## 1K STATIC (CMOS)



**HM435101V**

Wide supply voltage margin  
( $V_{CC}=5V \pm 10\%$ )  
All input and output are  
TTL compatible  
Access Time  
650ns max HM435101V

## MOS ROM

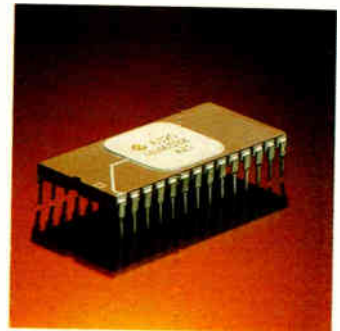

**HN46532**

32K bits MOS ROM (4k x 8b)  
Access Time  
650ns HN46532

### DYNAMIC RAMs

Type	Process	Organization (word x bit)	Access Time (max)	Package	Replacement
HM4704-1	NMOS	4096 x 1	200ns	16DIP	Mostek MK 4027
HM4704-2	NMOS	4096 x 1	250ns	16DIP	
HM4710	NMOS	4096 x 1	100ns	22DIP	
HM4711-1	NMOS	4096 x 1	130ns	22DIP	
HM4711-2	NMOS	4096 x 1	150ns	22DIP	
HM4711-3	NMOS	4096 x 1	200ns	22DIP	Intel 2107B

### MOS ROMs

Type	Process	Organization (word x bit)	Access Time (max)	Package	Replacement
HN35600P	PMOS/Mask	256 x 8	930ns	16DIP	Intel 4001
HN35800P	PMOS/Mask	1024 x 8	930ns	28DIP	Intel 4308
HN351702A	PMOS/E.P	256 x 8	1000ns	24DIP	Intel 1702A
HN46532	NMOS/Mask	4096 x 8	650ns	28DIP	
HN46830A	NMOS/Mask	1024 x 8	500ns	24DIP	Moto MCM45830A
HN462708	NMOS/E.P	1024 x 8	450ns	24DIP	Intel 2708

### STATIC RAMs

Type	Process	Organization (word x bit)	Access Time (max)	Package	Replacement
HM435101	CMOS	256 x 4	650ns	22DIP	Intel 5101L
HM435101V	CMOS	256 x 4	650ns	22DIP	
HM435101-1	CMOS	256 x 4	450ns	22DIP	Intel 5101L-1
HM452102-3	NMOS	1024 x 4	350ns	16DIP	Intel 2102A
HM452102-4	NMOS	1024 x 4	450ns	16DIP	Intel 2102A-4
HM46810A	NMOS	128 x 8	450ns	24DIP	Moto MCM6810A

### BIPOLAR RAMs

Type	Family	Organization (word x bit)	Access Time (max)	Package	Replacement
HM2110	ECL	1024 x 1	35ns	16DIP	F.C 10415A
HM2110-1	ECL	1024 x 1	25ns	16DIP	
HM2510	TTL	1024 x 1	70ns	16DIP	F.C 93415
HM2510-1	TTL	1024 x 1	45ns	16DIP	F.C 93415A



**Hitachi, Ltd. Electronics Devices Group**  
6-2, 2-chome, Otemachi, Chiyoda-ku, Tokyo 100  
Telephone: Tokyo (270) 2111 Cable Address: "HITACHY" TOKYO  
Telex: J22395, 22432, 24491, 26375

#### For inquiry write to:

#### Hitachi America, Ltd.

Chicago Office, Electronics Department  
2700 River Road, Des Plaines, Illinois 60018  
Telephone: (312) 298-0840 Telex: 72-6353

#### Hitachi, Ltd.

4 Düsseldorf, Immermann Strasse 15,  
Deutschland Telephone: 0211-353073 ~ 353077  
Telex: (41) 8587385 (8587385 HITA D)

**Hitachi Electronic Components (U.K.) Ltd.**  
Hitachi House, Station Road, Hayes,  
Middlesex, UB3 4DR Telephone: (848) 8787  
Telex: 936293 (HITELECTRO HYES)

## New products

Subassemblies

### A-d converters miss no codes

Military model guarantees all output codes over full  $-55^{\circ}\text{C}$  to  $+125^{\circ}\text{C}$  range

For users of analog-to-digital converters who want to be sure that the device's output corresponds precisely to its input, designers at Analog Devices have come up with the AD572 series of hybrid 12-bit successive-approximation a-d converters. The company guarantees the units will have no missing output codes over all or most of their operating temperature ranges.

Indeed, one of them, the AD572S, aimed at military and aerospace applications, is guaranteed for this and all other performance specifications over the full  $-55^{\circ}\text{C}$  to  $+125^{\circ}\text{C}$  range. The two others are specified for  $-25^{\circ}\text{C}$  to  $+85^{\circ}\text{C}$ , the 572B being guaranteed to have no missing codes

over the entire range and the 572A being guaranteed for  $0^{\circ}$  to  $+70^{\circ}\text{C}$ .

Stan Harris, director of marketing at the Microelectronics division, maintains that for their price, these a-d converters are the most accurate available in terms of performance over temperature. In quantities of 1 to 24, the 572A sells for \$95 each, the 572B for \$125, and the 572S for \$250.

Maximum conversion time for all three devices is 25 microseconds. The other key specs, says Harris, are nonlinearity accuracy, low power consumption, and low temperature coefficients. All three have a maximum nonlinearity of 0.012% and consume 900 milliwatts. Maximum gain tempco for the 572C is  $\pm 25$  ppm/ $^{\circ}\text{C}$  over the full military temperature range ( $\pm 15$  ppm/ $^{\circ}\text{C}$  from  $-25^{\circ}$  to  $+85^{\circ}\text{C}$ ), and reference tempco is  $\pm 10$  ppm/ $^{\circ}\text{C}$  maximum.

Gain tempco for the 572A is  $\pm 30$  ppm/ $^{\circ}\text{C}$ , and  $\pm 15$  ppm/ $^{\circ}\text{C}$  for the 572B. Reference tempcos are  $\pm 20$  ppm/ $^{\circ}\text{C}$  and  $\pm 10$  ppm/ $^{\circ}\text{C}$  for the 572A and B, respectively. All three contain, in addition to the analog switch array and laser-trimmed resistor network, an internal buffer

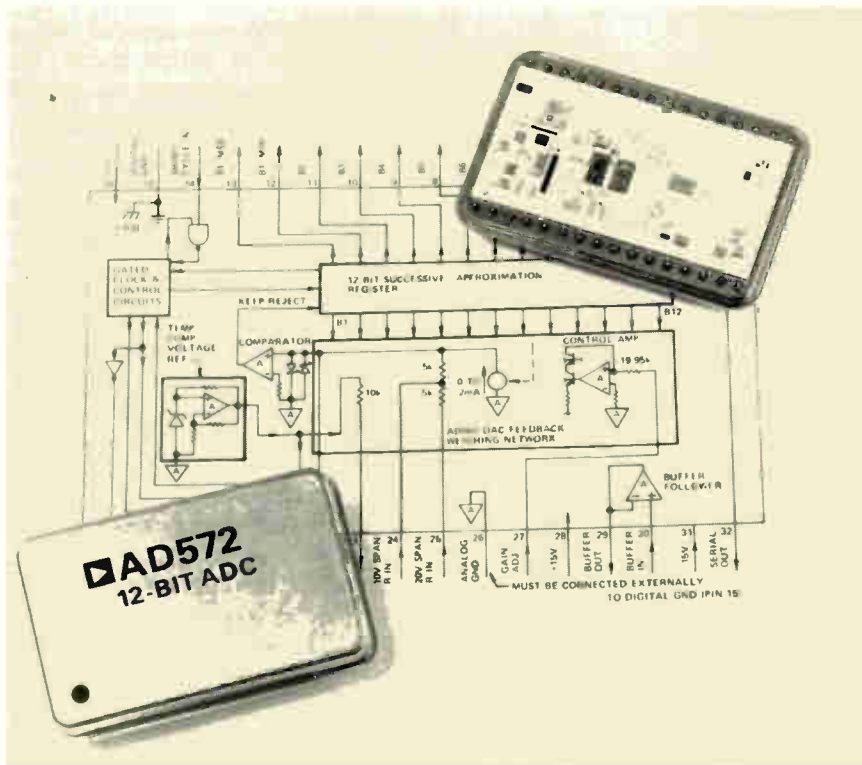

## Industry Standard A/D and D/A 12-Bit Converters

Now in Hermetic Packages

The Micro Networks DAC 80 and ADC 80 combine low cost and high performance to make them your best buy for industrial control and instrumentation applications

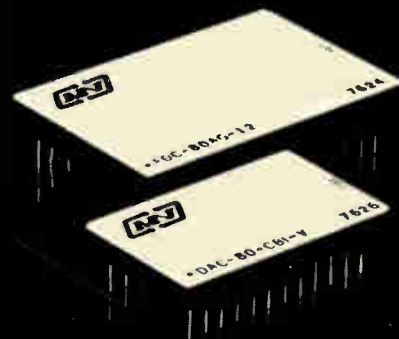

**DAC 80**  
**\$19.50\***  
**ADC 80**  
**\$47.50\***

\* in 100 quantities



Micro Networks Corporation  
324 Clark Street, Worcester, MA 01606  
(617) 852-5400 TWX 710-340-0067

# The Noise Loading Test Set

## MEV8

The MEV8 consists of the Noise Receiver ML415A and the Noise Generator MG431A. It is best to measure the performance of radio relay and cable systems for frequency division multiplex telephony under conditions closely approaching those of actual operation.



- Meets the latest CCIR and CCITT recommendations.
- Suitable for systems of 24 to 2700 channels or more (10kHz to 18MHz).
- Easy replacement of plug-in filters and accommodation up to 7 measuring frequencies simultaneously.
- Direct reading dial of noise level (absolute or relative) and noise ratio (NPR or S/N) with or without weighting.
- TRANSMISSION LEVEL dial and DIFFERENCE FROM TL dial facilitating measurements.
- Easy operation by remote control from the Noise Receiver to Noise generator.
- Low intrinsic thermal noise minimized at -130 dBm.
- Inband and out-of-band measurements.

# Anritsu

**ANRITSU ELECTRIC CO., LTD.**

MEASURING INSTRUMENTS DIVISION

SALES DEPARTMENT:

12-20, Minamiazabu 4-chome, Minato-ku, Tokyo 106, JAPAN

Phone: (03) 446-1111/Telex: 0-242-2353

Cable: ANRITDENKITOKYO

U.S.A. Tau-Tron Inc. Tel: (617) 667-3874 • West Germany Knott Elektronik GmbH Tel: (0 8178) 4085 • England Dymar Electronics Limited Tel: Watford 37321 • France Tekelec Airtronic Tel: (1) 946-96-48 • Italy Vianello S.p.A. Tel: 544041 • Holland Uni-Office B.V. Tel: (010) 22 94 44 • Sweden Teleinstrument AB Tel: 08-38 03 70 • Singapore O'Connor's (Pte.) Ltd. Tel: 637944 • Australia NEC Australia Pty. Ltd. Tel: Melbourne 560-5233

## New products

amplifier, comparator, clock, and a precision reference—a zener chip plus operational amplifier rated at 10 volts,  $\pm 5$  millivolts. Harris says the reference can be used for applications on a printed-circuit board external to the converter.

All three versions are in a welded, hermetically sealed 32-pin dual in-line package. Welding was chosen as the sealing method, Harris says, because with soldering solder balls or flux might get inside the package and contaminate the device. Further, the metal package shields the converter from electrostatic and radio-frequency interference, which can interfere with its accuracy and cause false or missing output codes.

Delivery is from stock to four weeks.

Analog Devices Inc., Box 280, Route 1 Industrial Park, Norwood, Mass. 02062. Phone Lowell Wickersham at (617) 329-4700. [381]

### F-v converter has low output ripple, modest linearity

Unlike most existing frequency-to-voltage converters, which have very good linearity accompanied by a large amount of output ripple, the model 22 is a low-cost unit with modest linearity and extremely low ripple—less than 0.5 millivolt peak-to-peak. Users who need both high linearity and low ripple can bypass the model 22's internal voltage-controlled oscillator and substitute an external voltage-to-frequency converter.

By itself, the model 22 is monotonic and linear to within 0.5% of full scale. It covers a four-decade range with a maximum frequency of 10 kilohertz, which can be lowered by using an external C-MOS divider to reduce the VCO frequency before it enters the converter's phase detector. Settling time after a step change in frequency is about 15 periods of the final frequency.

The model 22 f-v converter sells for \$39 in unit quantity, \$34 each for 10 to 24 units, and \$29 each for 25 and up. Delivery of the devices is

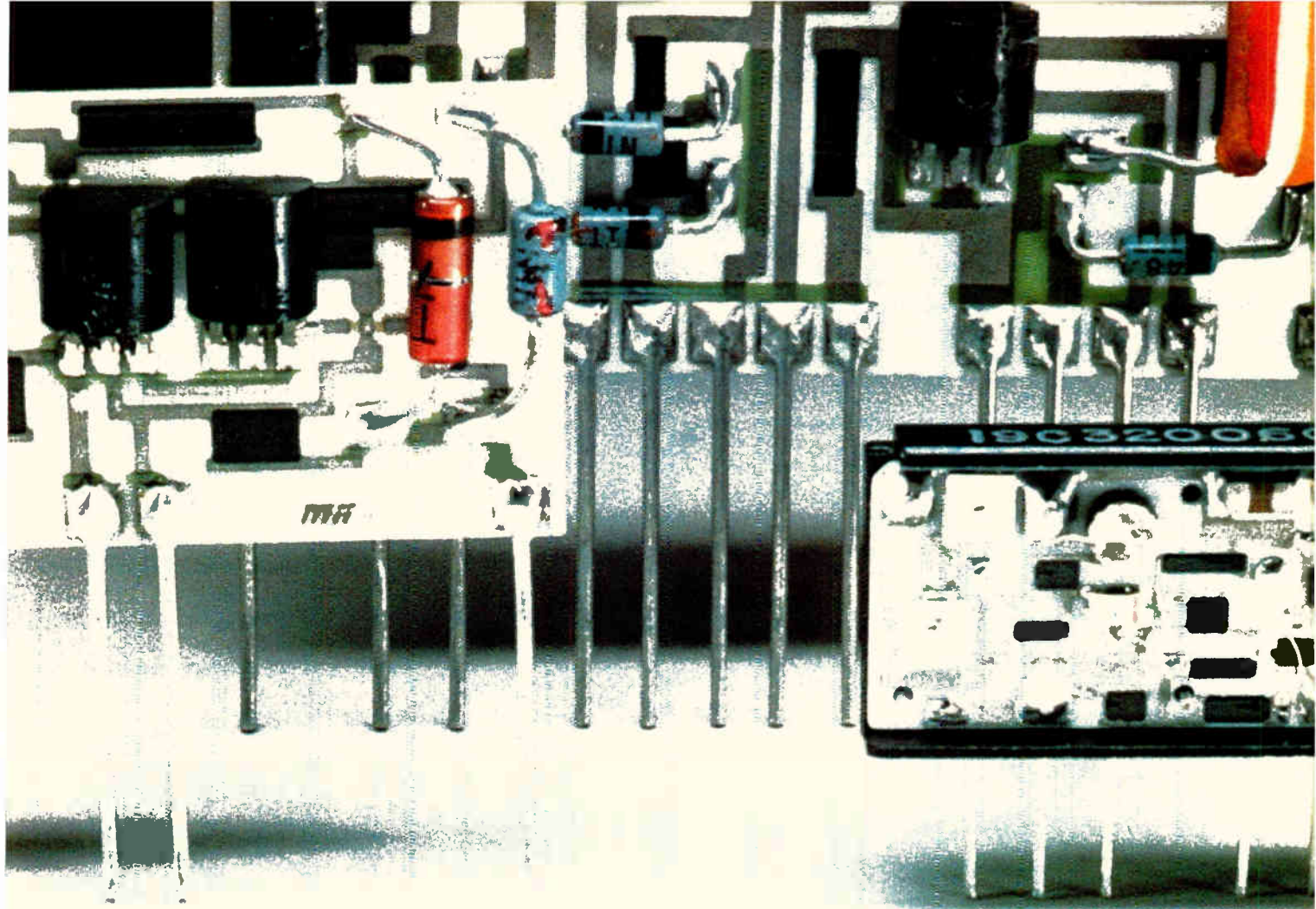

## Now Du Pont FORMON® Solder Compositions put it all together for thick film hybrid circuits.

Du Pont FORMON® Solder Compositions give you the same solid cost and performance benefits you've seen in Du Pont's complete compatible systems of conductor, resistor and dielectric compositions.

Unlike wave or dip soldering, FORMON Solder Compositions are selectively screen printed and reflowed, giving you:

- Constant alloy composition and consistent performance. You avoid solder pot contamination.
- Controlled deposition. Screen printing puts solder only where you

want it—away from sensitive components and without "bridging" between adjacent conductors.

- Simple component assembly. Components are easily positioned on the wet solder paste, holding the components in place through reflow.

The complete line of FORMON Solder and Braze Compositions includes a full range of alloys and melting temperatures compatible with Du Pont conductors. All materials are backed by comprehensive quality control to assure purity and batch-to-batch consistency.

Du Pont Conductor Compositions	FORMON® Solder Compositions
Pd/Ag 9308 Pt/Ag 9770	10 Sn/88 Pb/2 Ag 8961 95 Sn/5 Ag 8518 62 Sn/36 Pb/2 Ag 8922
Pt Au 9596 Pt Au 9885	10 Sn/90 Pb 8520 60 Sn/40 Pb 8522
Au 9791 Au 9910	88 Au/12 Ge 8513 80 Au/20 Sn 8511 50 Pb/50 In 9557

If you manufacture or assemble thick film hybrid microcircuits or passive components, come to Du Pont Electronic Materials Division, the systems people in thick films. Write the Du Pont Company, Room 25451, Wilmington, DE 19898.

## Electronic Materials Division



**Electronics**

World Radio History

Circle 147 on reader service card

# DANA INTRODUCES THE SMART COUNTER.

## Series 9000: World's First Microprocessing Timer/Counter.

The Dana Series 9000 is smart enough to make your work a lot easier. Microprocessing controls provide all the features of a premium timer/counter, a reciprocating counter and a calculator. Plus interfacing options and operating capabilities never before available in one instrument.

The Dana Series 9000 Microprocessing Timer/Counter goes so far beyond all other counters it takes a whole brochure just to explain its capabilities. Ask for it. It's the smart thing to do.

Dana Laboratories, Inc., 2401 Campus Drive, Irvine, California 92664, 714/833-1234.



For Product Demonstration Only circle 148  
For Literature Only circle 218

## CAREER OPPORTUNITIES

Usually the best opportunity to grow in your field lies within your present company. You have made an investment in them. They have an investment in you.

But occasionally the best opportunity lies somewhere else. No one can decide but you.

Companies looking for good people run their recruitment ads in our Classified Section in the back of this magazine. Perhaps you'll find an opportunity there that's worth following up.

## New products

from stock to about four weeks. D-B-Developments, 7709 Kilbourne Rd., Rome, N.Y. 13440. Phone Dave Manzolini at (315) 339-1265 [383]

## Potting increases power-supply reliability

Because microcomputer systems demand very high reliability from their power supplies, Dynamic Measurements Corp. has developed a line of premium supplies that are completely encapsulated in hard epoxy. The solid molding, which the company explains is extremely unusual for supplies in the 30-watt range, provides excellent thermal conductivity,

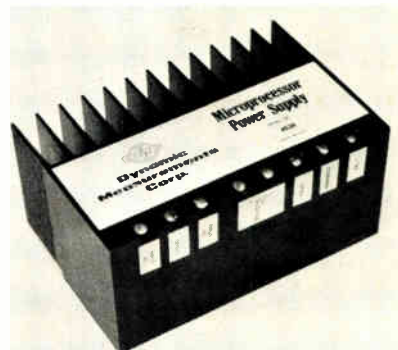

and permits operation without derating in ambients up to 40°C.

Measuring 6.1 by 4.25 by 3 inches, the supplies are available in single-, double-, and triple-output versions. Total regulation (line plus load) is within 0.03% for the 5-volt output and within 0.01% for the 9-, 10-, 12-, and 15-v outputs. Tracking between positive and negative outputs is within 100 ppm/°C, and maximum output voltage error is between 0 and +1%. Standard functional options include Faraday shielding, 5-v overvoltage crowbar, and various input-voltage ranges.

Single-unit pricing is \$130 for the single-output supplies, \$140 for the double, and \$155 for the triple. Delivery is from stock to four weeks.

Dynamic Measurements Corp., 6 Lowell Ave., Winchester, Mass. 01890. Phone (800) 225-1151 [384]



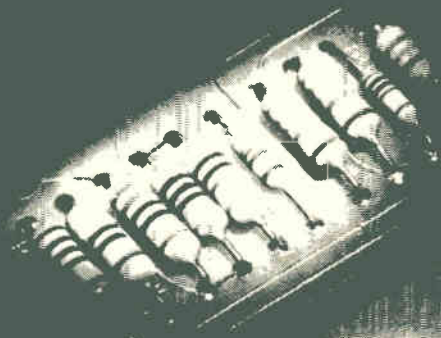

**Save 30%  
on-the-board cost.**



# Now, an alternative in the precision resistor world.

## Beckman introduces precision film networks.

The board geography savings are obvious.

But our standard, 16-pin Series 698 Precision Film Resistor Networks mean much more. First, they're competitive in purchase cost with thin film discrete resistors. And, when you consider inventory and handling costs, lead bending, QC and other factors, they mean about a 30% savings in "on-the-board" costs.

That isn't all. Beckman precision networks have better performance and stability than unmatched discretetes. With  $\pm 5$  ppm/ $^{\circ}$ C tracking, the matched resistors in our dual in-line packages feature (1) absolute 1% resistance tolerance ratioed to 0.5%, and (2)  $\pm 50$  ppm/ $^{\circ}$ C tempo.

The two models (see schematics) are standard size and pin-spaced for automatic insertion. Series 698-1 comes in 17 stock resistance

values; Series 698-3 in 20 stock values. And these parts can be coupled, in series or parallel, to obtain other values in gain-setting, summing and feedback circuit applications.

The 1,000-piece price: just 65¢ for the 698-3 (8 resistors), 81¢ for the 698-1 (15 resistors). Compare with discretetes!

And remember: they're standard... for quick delivery, off the shelf through our widespread distribution.

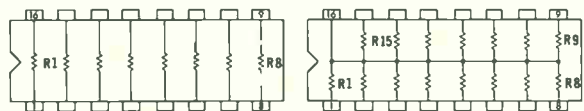

Get into the world of precision resistor networks. For more data, and applications information, contact your local distributor or Beckman Helipot today at (714) 871-4848, Extension 1776.

# BECKMAN®

HELIPOT DIVISION

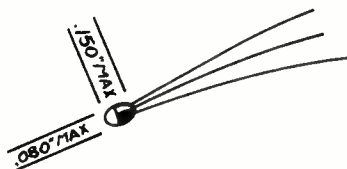

## Linear temperature information... and thermistor sensitivity, too

Small size,  $\pm 0.2\%$  linearity, long-term stability,  $\pm 0.15^\circ\text{C}$  interchangeability. YSI Thermilinear<sup>®</sup> thermistors translate  $-30^\circ$  to  $+100^\circ\text{C}$  temperature data for **digital readout** and precision temperature compensation. A simple signal conditioner provides linear outputs to  $30\text{ mV}/^\circ$  with **numeric correspondence for direct interface** with DVM's. YSI linear thermistors are **ideal building blocks for sensitive, stable, digital readout systems**. Write for specifications.



Industrial Division  
Yellow Springs Instrument Co., Inc.  
Yellow Springs, Ohio 45387

Circle 150 on reader service card

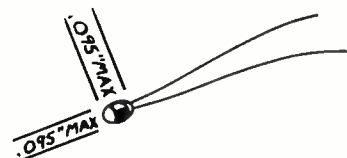

## Space-qualified thermistors... with documented performance, too

Now available **off-the-shelf** in designer quantities, precision interchangeable **thermistors tested to GSFC S-311-P-1801** for precision temperature measurement, control and compensation in extended space flight applications. But if your needs are more earth-bound, these same precision thermistors, with or without special testing, calibration or documentation, are **available for critical industrial and scientific applications** from  $-40^\circ$  to  $+150^\circ\text{C}$ . Write for specifications.



Industrial Division  
Yellow Springs Instrument Co., Inc.  
Yellow Springs, Ohio 45387

150 Circle 219 on reader service card

## New products

Microprocessors

## Data board fits Intel computers

16-channel system includes 12-bit a-d converter, sells for only \$495

The series 735 one-board data-acquisition systems plug directly into the same card cage as the Intel SBC-80/10 and SBC-80/20 microcomputers and the MDS-800 microcomputer-development system. Priced at only \$495 in lots of 1 to 9, the basic 735 provides 16 single-ended or 8 differential input channels, a sample-and-hold module, a fast 12-bit analog-to-digital converter, and logic circuitry to interface with the computer bus.

Options include up to two 12-bit digital-to-analog converters, a software-programmable input amplifier, and a dc-to-dc converter for the

analog circuitry. This converter is needed if the 735 is to be used in a system where  $\pm 15$ -volt power is not available.

The amplifier allows a choice of one of four gains for each input channel, and two sets of four are available: 1, 2, 4, and 8, or 1, 2, 5, and 10. The system throughput rate is 35 kilohertz. In the voltage-output mode, there is an optional third-wire sense for the d-a converters. It adds \$20/channel to the converter price of \$125 for one, \$215 for two.

To enhance flexibility, the 735 series bus interface offers a choice of program control or program interrupt through software and choice of memory-mapped input/output or isolated I/O by means of a jumper. When the interface is structured as a memory-mapped I/O, the microprocessor treats the data-acquisition system as a number of memory locations. Of course, memory-mapped I/O is preferred for new designs. But with older designs, simply moving the jumper permits isolated I/O points.

Delivery time for the 735 is four

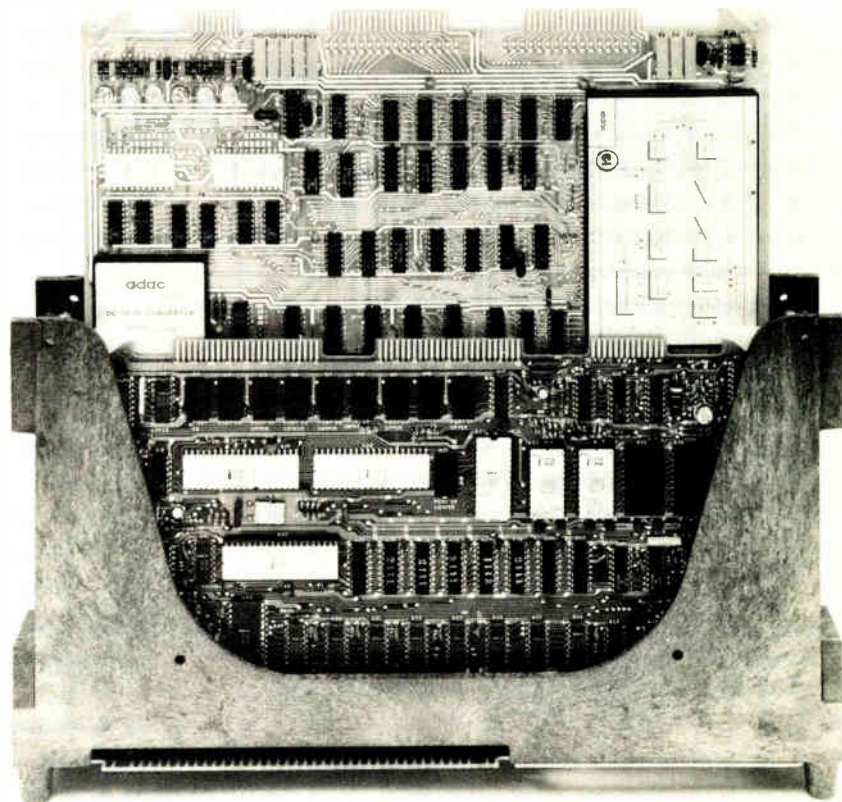

# OUR TRIDENTS ARE SO WELL MADE THEY'LL COME APART IN 10 MINUTES.

We've made it very easy for you to get to all the parts and components of every Trident disk drive.

You can remove all sub-assemblies without using a soldering iron. They all either slide right out, or fold out on hinges.

You can connect an exerciser to troubleshoot without removing any system cables.

The degate switch on every Trident lets you take out one drive for repairs without interrupting the others.

And since all critical sub-assemblies are enclosed to prevent contamination, they stay clean when the skins are off.

## MAINTENANCE

All this means that when you need to maintain a Trident, you don't have to pamper it.

You can take it apart fast. Get the work done simply. And get it back together fast.

But design excellence is only part of the Trident story. Capacities range from 27 to 312 megabytes, and each Trident model is fully compatible with every other Trident model.

Each gives you track-following servo technology—plus one of the lowest cost-per-byte ratios in the industry.

## TRIDENT FORMATTER

Our 1150A Formatter is also easy to maintain. It offers micro/minicomputer systems designers important features



previously available only in large disk controller subsystems. Features like ECC, RPS, and overlapped seek.

It can control and format any mix of up to eight Trident drives—for a total storage capacity of up to 2.4 billion bytes online. And it can be attached to virtually any micro/minicomputer.

## STATE OF THE ART

If features like these are important to your growing systems business, you'll want more data on the state-of-the-art Trident family. Just call us at (714) 821-2011, or fill out the coupon. We'll do the rest.

EM-M3-77

To: California Computer Products, Inc. MS3  
2411 West La Palma Avenue  
Anaheim, California 92801

Please tell me all about your Trident Disk Drives.  
 I am interested.  I am serious.

Name \_\_\_\_\_  
Company \_\_\_\_\_ Title \_\_\_\_\_  
Address \_\_\_\_\_ Phone \_\_\_\_\_  
City \_\_\_\_\_ State \_\_\_\_\_ Zip \_\_\_\_\_

Circle 151 on reader service card

**CALCOMP**  
World Radio History

## Ceramaseal Mini- and Submini Feedthrus

- Single, dual and quad assemblies, and submini octal assemblies.
- Ultra-high-vacuum tight
- Ceramic-metal
- Minis bakeable to 400°C, Subminis to 550°C
- Weld adapter or vacuum flange mounted
- Brazable subminis

### Request Bulletins

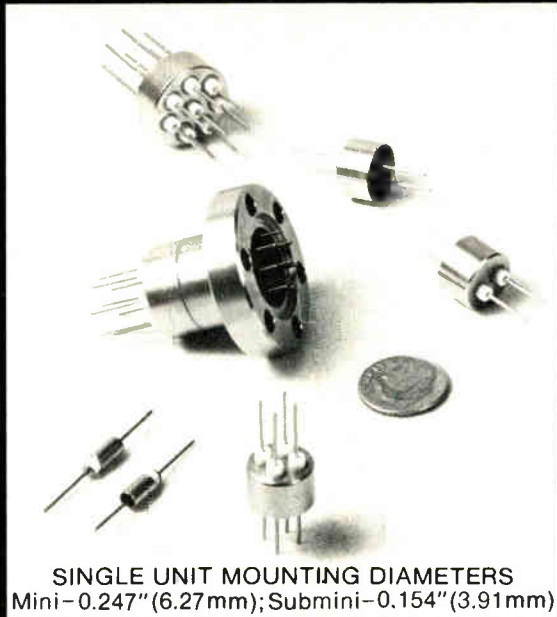

758MU  
(Mini)

and

766 SMU (Submini).

## Ceramaseal, Inc.

A SUBSIDIARY OF INTERPACE CORPORATION

NEW LEBANON CENTER, NEW YORK 12126 (518) 794-7800 • Telex 14-5442

Circle 152 on reader service card

## Amazing AIRBRASIVE<sup>®</sup> "Wonder Tool"

It can cut or etch. Or strip and clean. Or drill and deflash. Amazing!

Try it. You'll wonder why you waited so long. You'll see why the versatile S.S. White Airbrasive tool is the low cost production tool for precision work on small electronic parts and components. It works on metals or glass, quartz or ceramics, the most delicate-to-handle semiconductor and crystalline materials. Airbrasive's stream of micro-abrasive particles gives you cool, shockless jet machining to the most critical tolerances. And at real savings in production time and labor costs. Wonder how much Airbrasive costs? Just \$825 for Model K—ideal for lab work, pilot runs, and similar light-duty, limited production. Model H, at \$1625, can deliver jet-machined production parts in high-volume to meet your most demanding production schedule.

Write for our illustrated brochure today. Or arrange for a demo and try the Airbrasive Wonder Tool on your parts. Write or call Jim McDonald, S.S. White Industrial Products, Pennwalt Corp., 151 Old New Brunswick Road, Piscataway, NJ 08854 (201) 752-8300.

Trademark of Pennwalt Corporation

S.S. WHITE  
**PENNWALT**  
EQUIPMENT ■ CHEMICALS  
HEALTH PRODUCTS

The "Wonder Tool"  
AIRBRASIVE



Precise and shockless enough to cut intricate patterns in an eggshell.

152 Circle 207 on reader service card

## New products

weeks. Some units are available immediately from stock.

Adac Corp., 15 Cummings Park, Woburn, Mass. 01801. Phone A.L. Grant at (617) 935-6668 [401]

Fast microcomputer sells for \$595 in kit form

Built around a high-speed version of the Z-80 microprocessor, the Z-2 microcomputer is a low-cost machine with a 250-nanosecond cycle time. Its price of \$595 in kit form or \$995 assembled includes a microprocessor card, a 21-slot motherboard, a



heavy-duty power supply that can put out 30 amperes at 8 v dc and 15 A from ±18 v dc, and a front panel. The kit includes one card-socket and card-guide set, while the assembled unit includes all 21 sockets and set of card guides.

The computer is configured to allow the user as many as eight independent banks of memory, each with a capacity of up to 64 kilobytes. This memory capacity, coupled with the computer's speed, allows it to handle real-time operations formerly handled by larger machines.

Cromemco Inc., 2432 Charleston Rd., Mountain View, Calif. 94043. [403]

One-board computer includes 16 kilobytes of RAM

Priced at only \$995 in small quantities, a one-board microcomputer called the SDB-80 is supplied with 16 kilobytes of random-access memory. Built round the Z-80 micropro-

Electronics/March 3, 1977

# When Price and Performance Both Count

**Compact 80, 520  
and 1,000 MHz  
Timer/Counters**

Until now, if you wanted a high performance timer/counter you expected a high price. That is, unless you could do without time interval averaging or if you could get by without trigger hold-off or if you don't mind the shortcomings of a plastic case. But, that's the way it was. Today our PM 6620 series offers total performance in a compact package at compact prices.

All three models provide for: 80 MHz direct frequency counting, single shot period and time interval measurements, period and time interval averaging, ratio and pulse counting and complete triggering facilities.

But that's not all! Depending on your individual needs, select one of three models:

- PM 6622 with trigger hold-off for even more versatile T.I. measurements .....
- PM 6624 with 520 MHz frequency range .....
- PM 6625 with 1000 MHz frequency range.....



And it doesn't end there! Each model is available with any of four timebase oscillators, BCD, IEEE Bus or analog output options, internal battery/charger and more. Add it all up and you have a most versatile family of timer/counters at very attractive prices. Why settle for less?

For immediate detailed information on the PM 6620 series utilize our toll-free number: 800 631-7172 (New Jersey residents call collect), or contact: Philips Test & Measuring Instruments, Inc.:

In the U.S.: 85 Mc Kee Drive  
Mahwah, New Jersey 07430  
Tel. (201) 529-3800

In Canada: 6 Leswyn Road  
Toronto, Ontario, Canada M6A 1K2  
Tel. (416) 789-7188



Circle 208 on reader service card

## PHILIPS

**This  
Publication  
is Available in  
MICROFORM**

from...

**Xerox University Microfilms**

300 North Zeeb Road,  
Ann Arbor, Michigan 48106  
(313) 761-4700

PLEASE WRITE FOR  
COMPLETE INFORMATION



## CHASSIS MOUNT MODULAR POWER SUPPLIES

The new CM series from Calex brings you the ultimate convenience in packaging. Prices start at \$39., for ±15V @ 50mA. Units are available with ±15V @ 200mA outputs, 5V @ 1 Amp and triple outputs also! For that next instrument design or bench supply, buy the best—buy Calex! Call or write for your complete brochure today.

**CALEX**

CALEX MFG. CO., INC. 3305 Vincent Rd.,  
Pleasant Hill, CA 94523  
(415) 932-3911

# DIONICS HIGH-VOLTAGE DISPLAY DRIVERS

## Highest

Highest-voltage monolithic IC's . . . up to 300 Volts!

## Widest

Widest variety of circuits available . . . for gas discharge (DC) and Plasma (AC)!

## Longest

Longest experience as the "Driving Force in the Industry" (since 1973) with Anode Drivers, Cathode Drivers, Level-Shifters!

## Latest

Latest Products Including: Level-Shifted Anode Drivers; Level-Shifted Cathode Drivers; Plasma Dot Matrix Drivers . . . many Interchangeable with National, Motorola and Sprague

## Swiftest

Swiftest with meaningful response to your inquiries . . . from our representatives worldwide!



**DIONICS INC.**

65 Rushmore St., Westbury, N.Y. 11590  
(516) 997-7474 TWX 510-222-0974

Circle 154 on reader service card

# HOPE

in a word is what we are.

Project HOPE exists because there are people with hope—people who have given 3.5 million men, women, and children on four continents the chance for happier, more productive lives through improved health care.

Give to

**PROJECT  
HOPE**

Department A  
Washington, D. C. 20007

## New products

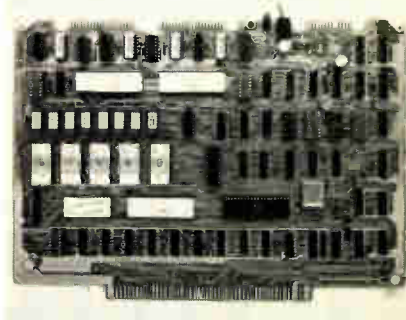

cessor family, the Software Development Board may also be purchased with a complete package of system firmware, which is contained in five on-board 2-kilobyte read-only memories. This firmware package allows the user to generate, edit, assemble, execute, and debug Z-80 programs.

Because the development software is contained in the ROMs, all of the RAM space is available for user programs. With the firmware, a set of interface cables for RS-232 terminals and model 33 Teletypes, and complete documentation, the SDB-80 is priced at \$1,395. If the RAM is reduced from 16 kilobytes to 4 kilobytes, the price drops to \$1,195.

Mostek Corp., 1215 W. Crosby Rd., Carrollton, Texas 75006. Phone (214) 242-0444 [404]

Read-only memory  
contains 32,768 bits

Believed to be the largest read-only memory on a chip to become available on the market today, the A66XX is a 32-kilobit device organized as 4,096 words of 8 bits each. The new ROM is expected to lower microcomputer costs by reducing the number of chips required for a particular application. For example, the basic operating and diagnostic software for an intelligent terminal, including a cathode-ray tube, a floppy-disk drive, a printer, and a keyboard, can be easily encoded on a single A66XX ROM.

The new ROM consists of more than 18,000 transistors and elements on a 156-by-242-mil chip. It features dynamic address-decoding and device-select circuitry. Up to 16 ROM

# MEMORY AT WORK

## Replacing four 2102s

If you're designing the 2102 into any application, stop. Look at our new SEMI 4804A.

It will quadruple your density, cut your power per bit in half. One SEMI 4804A static

1K x 4 RAM is functionally identical to and will replace four 2102s (or 2112s).

It operates on 5V, reads and cycles in 450 nsec., and is available now from your

local EMM SEMI distributor. (If you need 4K x 1 organization, ask about

our new SEMI 4801. That's available immediately, too.)

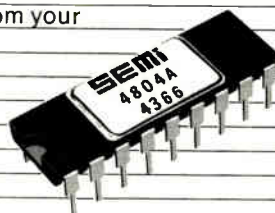

Write or call today

for full details.

**EMM SEMI**

A subsidiary of

Electronic Memories & Magnetics Corp.

3883 N. 28th Ave., Phoenix, Ariz. 85017

(602) 263-0202



**EMM**

# Why did Motorola choose Wintek 6800 micro software?

For the same reasons as:

**Tektronix**  
**Bendix**  
**Union Carbide**  
**Hewlett Packard**  
**U. of California**

**NASA**  
Baldwin Electronics  
Robert Shaw Control  
Digital Communications  
Vought  
U.S. Military

PL/W Cross Compiler	\$1000.00
Cross Assembler	\$600.00
Simulator	\$600.00
Linking Loader	Free

All software written in Fortran IV for PDP/11, NOVA, etc. Also available on **TVMSHARE™**

For more information on why you should choose Wintek, call or write:



Wintek Corporation  
902 N. 9th St.  
Lafayette, IN 47904  
317/742-6802

## New products

circuits can be directly selected with the device's 12 address and 4 chip-select inputs. As with all Rockwell PPS microprocessor circuits, the A66XX is priced as part of a system or microcomputer.

Rockwell International, Microelectronic Device Division, 3310 Miraloma Ave., P.O. Box 3669, Anaheim, Calif. 92803 [405]

## Disk controller supports PDP-11 systems

The MSC-1000 is a microprocessor-based controller that supports storage module devices with capacities from 25 to 300 megabytes per spindle. Its microprogrammed design suits it particularly well for use with Digital Equipment Corp. PDP-11

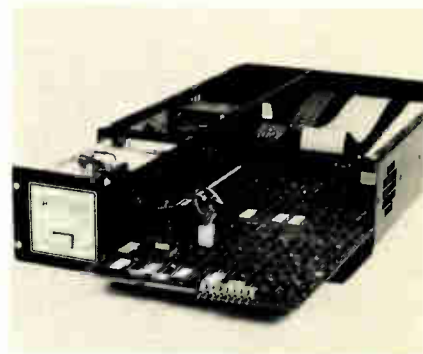

minicomputers. The controller can issue memory reference requests on the Unibus, making it unnecessary for the central processing unit to send the entire command through the host-adaptor (interface-card) registers. Instead, the host CPU simply passes the address of the head of a chained command list to the controller. As commands are completed, control and status information is posted in interrupt-driven mailbox registers within the host adaptor. Its microprogrammed design permits the MSC-1000 to respond as an RK11 or RP11 for bootstrapping purposes, says the manufacturer. The base price for the controller/formatter and a single host adaptor is \$7,900.

Microcomputer Systems Corp., 440 Oakmead Parkway, Sunnyvale, Calif. 94086. Phone (408) 733-4200 [406]



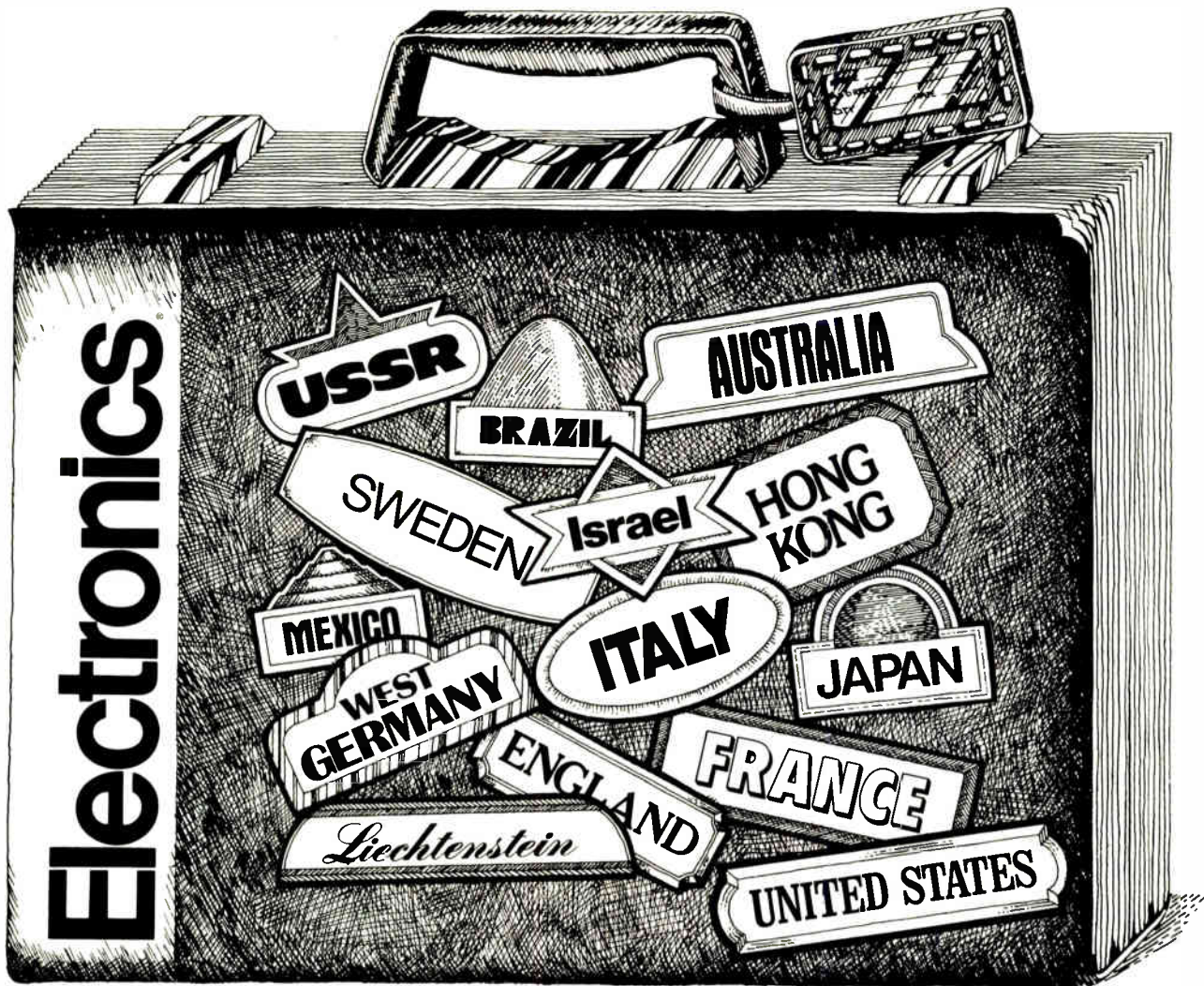

What are your colleagues doing  
around the world?

Find out in **ELECTRONICS**.

Go first class. Go to **ELECTRONICS** and you'll find out first hand where the biggest growth potential is today. And where it'll be tomorrow.

**ELECTRONICS** knows, because its 31 editors, 11 World News Bureaus and 200 correspondents make it their business to stay on top of what's happening in the ETM—the Electronics Technology Marketplace—worldwide. Only **ELECTRONICS** offers readers annual market reports and forecasts on Japan and Europe as well as the U. S.

**ELECTRONICS** is *the Source*, disseminating information, and establishing and maintaining communications among people in electronics,

wherever in the world those people may be.

We sell over 86,000 subscriptions to 122 countries all over the globe. You should be getting your own copy of **ELECTRONICS** right off the press because the world of electronics—your world—is between the covers of **ELECTRONICS** magazine.

Fill out the enclosed subscription card and send it off. **ELECTRONICS** is the one magazine you can't afford to be without.

**Electronics**   
**IS THE SOURCE.**

# Now, analog output is just this simple.

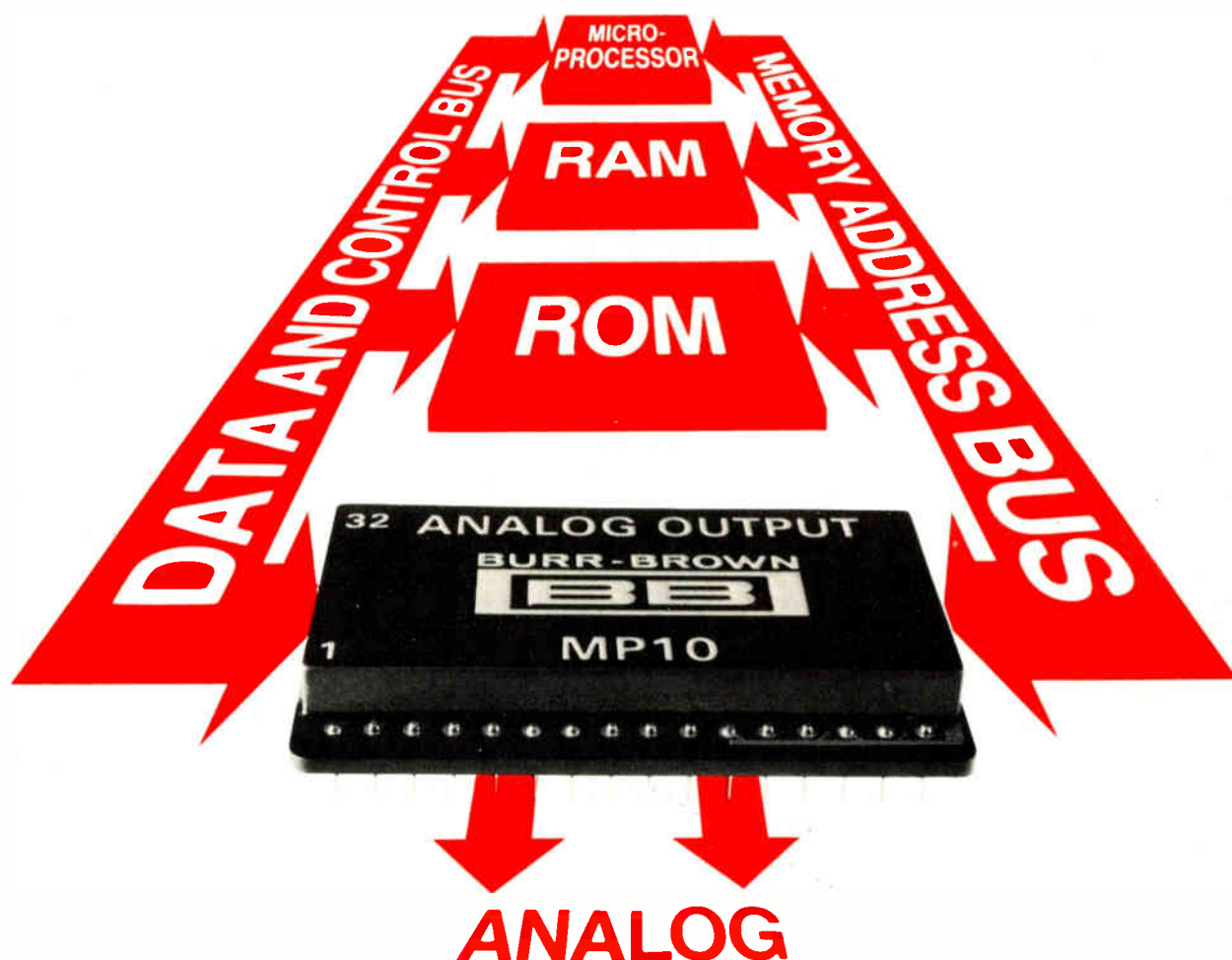

You no longer need to assemble D/A converters, address decoders and interface logic to obtain analog output from your microprocessor-based systems. Burr-Brown has solved the problem completely—for most of today's popular microprocessors—with 32-pin DIP's that provide two analog output channels each and look like memory to your CPU.

For 8080A and 8008 type  $\mu$ Ps you need our new MP10. And for 6800, 650X and 9002 types, our MP11. Both of these bus-compatible Analog Output Microperipherals are self-contained, requiring no external components for most systems. And since they're treated as memory by the CPU, just one 8-bit memory location is required per channel, and a single instruction is all you need to output data to both channels.

Circle 240 on reader service card

See us at Salon des Composants  
Electroniques, Allée F, Stand 46.

For analog input applications, you can combine one channel of an MP10 or MP11 with a few external components and use the microprocessor to perform the logic of a successive approximation A/D converter. The second channel continues to function as an analog output.



Both the MP10 and MP11 provide  $\pm 10V$  outputs with 8-bit resolution and throughput accuracy better than  $\pm 0.4\%$  of full scale range. With the low price of these products, it just doesn't make sense to design your own analog I/O solutions. Send for details today. Write or call Burr-Brown, International Airport Industrial Park, Tucson, Arizona 85734. Phone (602) 294-1431.

**BURR-BROWN**



*Leaders in  
microcomputer I/O.*



## New products

Data handling

### Signal processor on plug-in board

Floating-point array device for Nova, Eclipse offers speed and \$10,000 price tag

By eliminating programming capability, Computer Design and Applications Inc. is able to sell a floating-point array-signal processor for only \$10,000 each in lots of 25, and delivery time is 60 days. This compares with the \$35,000 to \$100,000 price tag on devices that perform voice processing, mechanical-design calculations, image enhancement, vibration testing, and similar data analyses. The more expensive parts are actually computers that have all the hardware necessary for loading and debugging programs.

CDA's MSP-2, built on a single plug-in board only 15 inches square, operates with Data General Corp.'s Nova and Eclipse minicomputers. The device maker claims its processor, which works with standard programs, can perform array calculations 10 to 50 times faster than

minicomputers programmed for such applications.

"To date, all signal processors of this kind have been minicomputers with weird architecture," says CDA president Robert Caspe. "They allow for user programming, and that's an expensive design. We've taken the approach that a processor need not be programmable in the classical sense."

The firm programs the MSP-2 from its standard array library for the OEM customer. Operations defined in the library can be executed either by Fortran subroutine calls or by straightforward input/output instructions in assembly language from the host computer. All boards, which are driven by programmable read-only memories, can be reprogrammed by CDA to accommodate changes in applications.

"By eliminating the parts for general programming, we've cut down the price considerably," Caspe notes. "Ninety percent of our customers won't be reprogramming anyway."

The MSP-2 reads and operates on input-data arrays stored in the host-computer memory. The board contains 2,048 words of high-speed block floating-point memory. Caspe points out that the use of 24-bit data words minimizes the digital error rate in highly iterative operations. For example, the MSP-2 can perform a 1,024-point fast Fourier transform including input/output transactions on data in the Nova memory in 6.7 milliseconds. It can execute a 512-point complex FFT in the same time span. Users can increase computing power by plugging in additional boards.

The processor is made predominantly of low-power Schottky and static complementary-MOS circuits. It operates within a temperature range of 0° to 70°C.

"Our intention is to come out with a spectrum of processors that will be attuned to a laboratory environment for real-time calculations," Caspe says. This spring, the company will introduce its model MSP-1, which will be compatible with Digital Equipment Corp.'s PDP-11 mini-



# MACOR™

Machinable Glass-Ceramic

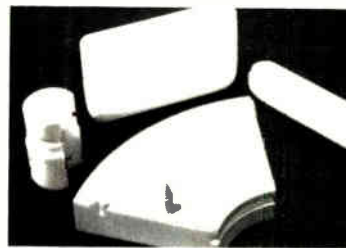

#### General

MACOR parts do not sacrifice strength, hardness, or porosity to achieve this machinability.



#### Machining

Only standard tools and equipment are required. Tolerances of  $\pm .0005$ " routinely achieved. Wafers cut as thin as  $.005$ ".



#### Metallization

Thick film metallization by using metal inks (silver, gold and silver/platinum). Thin film metallization by sputtering.

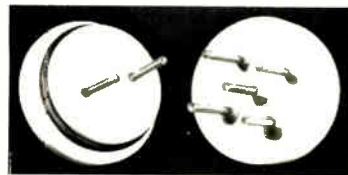

#### Sealing & Joining

Hermetic seals using glass frits good to 800°F. Strong joints using epoxy. Soldered joints on metallized parts.

#### Features at a Glance

Machinable with ordinary metalworking tools. No firing needed after machining. Excellent dimensional stability. Good thermal shock resistance. Ultra high dielectric strength. Compatible thermal expansion coefficient. Low thermal conductivity. Low loss tangent. Zero porosity and zero water absorption. Non-magnetic.

Machinable Glass Ceramic Dept.  
Corning Glass Works, Corning, N.Y. 14830

## CORNING

# WE'VE GOT THE EDGE ON PRINTING

... built into our thermal recorders

Log your alphanumeric data adjacent to the analog signals you're tracking.

We'll print a single row or up to five lines of information simultaneous with the analog recording.

TO ADD THIS EDGE  
TO YOUR PRODUCTS  
CALL OR WRITE  
KEN GRABEAU AT  
(603) 893-1921

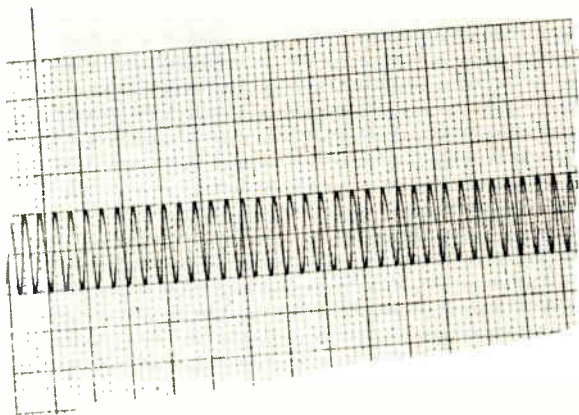

KEEWAYDIN DRIVE, SALEM, N.H. 03079 U.S.A.

MFE PRODUCTS SA  
AV. DU GENERAL GUISSAN 58  
CH-1800 VEVEY SWITZERLAND  
TELEPHONE 021 52.80.40  
TELEX 26238 MFEPR CH

## New products

computer, notes CDA's president.  
Computer Design and Applications Inc., 375  
Elliot St., Newton Upper Falls, Mass. 02164.  
Phone (617) 964-4320 [361]

Teletype uses 9-wire printer  
for better looks and life

The model 43 Teletype teleprinter,  
priced below \$1,000, has a nine-wire  
matrix printhead mechanism that



improves printing quality and in-  
creases service life. Compatible with  
systems that support the popular  
model 33 teletypewriter, the 43  
prints both upper- and lower-case  
characters at rates up to 30 charac-  
ters per second. A receive buffer and  
the printer's capability to run at  
"catch-up" speed make for a true-  
throughput rate of 30 characters per  
second.

Operator controls include switches  
to select half- or full-duplex opera-  
tion, 10 or 30 characters per second,  
parity on/off, and a printer test. The  
teleprinter accommodates up to  
three-ply fanfold paper on which it  
can print up to 132 columns across  
an 11-inch width.

Teletype Corp., 5555 Touhy Ave., Skokie, Ill.  
60076. Or call Terminal Central at (312)  
982-2000 [363]

Processor module includes  
LSI-11 microcomputer

Aimed at educational and small-  
business applications, the Terak  
8500 series minicomputer is a mod-  
ular tabletop system. Its nucleus is a  
self-contained disk-based model  
8510 data processor, which contains

# Achtung!

Für eine reibungslose Abfertigung Ihres Bezugs- oder Erneuerungs-Antrages für ELECTRONICS benötigen wir *alle* auf dem Fragebogen verlangten Auskünfte (Muster beiliegend). Unser Computer nimmt unvollständig ausgefüllte Bogen nicht an.

Bitte besonders auf Fragen 2, 3, 4 und 5 achten.

Um Verzögerungen und unnötigen Schriftwechsel zu vermeiden, füllen Sie bitte alle bezeichneten Felder aus.

# Atención!

Afin de nous permettre d'acheminer votre souscription initiale ou de renouvellement pour ELECTRONICS nous vous prions de nous donner *toutes* les informations demandées dans le questionnaire (specimen ci-dessous). Notre ordinateur rejette toute forme incomplète.

Veuillez prêter attention particulièrement aux questions 2, 3, 4 et 5.

Pour éviter tous délais et correspondances superflues, rassurez-vous d'*avoir rempli toutes les cases*.

# Attention!

In order to process your Electronics subscription application or your renewal request, we have to receive *all* the information requested on the form (see sample below). Otherwise, our computer will reject the application.

Please pay particular attention to questions 2, 3, 4, and 5.

To save unnecessary delay and additional correspondence, be sure to *complete all areas indicated*.

**Electronics**

PLEASE ENTER MY SUBSCRIPTION TO ELECTRONICS FOR:

1.  ONE YEAR AT \$35.00  
 THREE YEARS AT \$87.50

Payment Enclosed  
 Bill My Company  
 Bill Me

NAME \_\_\_\_\_ TITLE \_\_\_\_\_  
COMPANY \_\_\_\_\_ DIV or DEPT \_\_\_\_\_  
COMPANY ADDRESS \_\_\_\_\_  
CITY \_\_\_\_\_ STATE \_\_\_\_\_ ZIP \_\_\_\_\_  
Check here if you wish publication to be sent to home address.  
STREET \_\_\_\_\_ CITY \_\_\_\_\_ STATE \_\_\_\_\_ ZIP \_\_\_\_\_  
Above rates apply only to those who answer all questions listed below. All others pay higher than basic price of \$25.00 per year.  
Signature \_\_\_\_\_

2.  PLANT  DEPARTMENT

Indicate the primary product manufactured or service performed at your plant (Box 1) and in your department (Box 2). Be sure to indicate applicable letter in each of the two boxes even if they are the same letter.

A. Large computers	K. Industrial controls, systems and equipment	U. Research and development organizations which are a part of an educational institution
B. Mainframe computers	L. Sub-assemblies	V. Government Agency and military
C. Computer peripheral equipment	M. Passive electronic components	W. Industrial companies using and/or incorporating electronic products in their mtg. research or development activities
D. Data Processing Systems (systems integration)	N. Active electronic components	X. Utilities
E. Office and business machines	O. Materials and Hardware	Y. Broadcasting sound and motion pictures and recording studios
F. Test and measuring equipment	P. Aircraft, Missiles, space and ground support equipment	Z. Commercial users of electronic equipment (railroads, pipelines, police, airlines)
G. Communications systems and equipment	Q. Oceanography and support equipment	9. College, University
H. Navigation and guidance or control systems	R. Medical electronics	
I. Consumer entertainment electronic equipment	S. Industrial equipment containing electronic components or products	
J. Other consumer electronic equip. (appliances, autos, hand tools)	T. Independent R&D laboratory and consultant	

3.  Indicate your principal job function (place applicable number in box. If numbers 9, 10, or 11 are used, fill in name, college or university).

- General and corporate management
- Design and development engineering
- Engineering services (evaluation, quality control, reliability, standards, tests)
- Basic research
- Manufacturing and production
- Engineering support (lab assistant, technician)
- Purchasing and procurement
- Marketing and sales
- Professor at \_\_\_\_\_
- Senior student at \_\_\_\_\_
- Graduate student at \_\_\_\_\_

Senior and graduate students are eligible for professional rate for one year subscription only.

4.  Indicate your principal job responsibility (place applicable number in box).

Management: 1. Engineering

5.    Your design function: (insert each letter that applies)

- I do electronic design or development engineering work
- I supervise electronic design or development engineering work
- I set standards for, or evaluate electronic components, systems and materials

6. Estimated number of employees at this location (check one):  
 1 to 49  50 to 249  250 to 999  over 1 000

Tell us one product your company makes.

What do you make in your department?

Which one of these describes your job?

Are you a manager (1) or an engineer (2)?

Don't overlook this question.

# Dialight LED Displays

The widest choice for your every application.

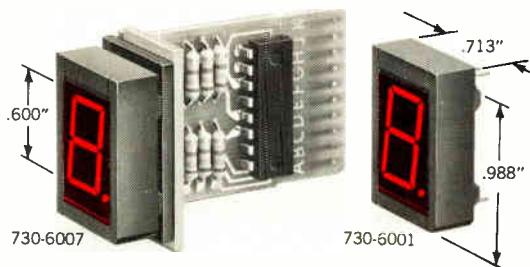

**730 SERIES** A new 0.600" LED character in super bright red, seven-segmented readout . . . low power . . . draws 10mA/segment or less . . . operates with standard IC power supply levels. Very high contrast ratio . . . visible from 40°. Available with or without on-board decoder/driver, plus or minus bar, and with bezel mounting. In 1000-lot quantities each LED  
**730-6007 . . . . \$6.95. 730-6001 . . . . \$2.55.**

**NEW  
LOW PRICES!**

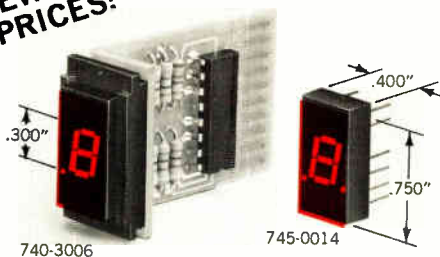

**745 SERIES** A new 0.300" LED character in a very bright red, seven-segmented readout . . . low power requirements. Standard 14-pin DIP . . . available with left and right decimal with  $\pm 1$ , and with and without on-board decoder/driver. Compatible with most TTL and DTL circuits. In 1000-lot quantities each  
**740-3006 . . . . \$4.58 745-0014 . . . . \$1.10.**



Dialight, the company with the widest choice in switches, LEDs, indicator lights and readouts, looks for needs . . . your needs . . . and then they develop solutions for your every application. No other company offers you one-stop shopping in all these product areas. And no other company has more experience in the visual display field. Dialight helps you do more with these products than any other company in the business, because we are specialists that have done more with them. Talk to the specialists at Dialight first. You won't have to talk to anyone else. Send for your free new copy of Dialight's current catalog.

**DIALIGHT**

Dialight, A North American Philips Company  
 203 Harrison Place, Brooklyn, N. Y. 11237  
 (212) 497-7600

# See Dialight.

## New products

a 16-bit Digital Equipment Corp. LSI-11 microcomputer. The processor has a flexible-disk drive that is compatible with the IBM 3740 format, a disk controller that can handle up to four drives, single serial interface circuitry with RS-232-C and 20-milliampere-current-loop signal levels, power supplies, and from 4,096 to 20,480 words of complementary-MOS read/write memory.

Other modules available are the 8512 flexible-disk subsystem, the 8530 data terminal equipped with a keyboard and a 12-inch cathode-ray-tube display, and the 8540 series of line printers. A complete small-business system sells for \$16,465. This includes a processor with 20 kilowords of memory, dual flexible-disk drives, the display terminal, an 80-column printer that operates at 300 lines per minute, a disk operating system, and Basic software.

Terak Corp., 14425 N. Scottsdale Rd., Suite 100, Scottsdale, Ariz. 85260. Phone Daniel Clark at (602) 991-1580 [364]

Disk formatter/controller fits on one chip

The only external logic that must be added to the FD1771 to form a complete floppy-disk formatter/controller is a clock/data separator on the input side and chip-select-decode logic on the output side. Everything else required to interface an off-the-shelf floppy-disk drive with a computer interface bus is contained on the chip.

As a controller, the FD1771 enables the user to seek any track, restore to track zero, step one track in either direction, and read single or multiple sectors. As a formatter, it can emulate IBM 3740 formatting or it can set up non-IBM formats.

The n-channel silicon-gate MOS device, housed in a 40-pin dual in-line package, sells for \$80 in small quantities. In hundreds, the price drops to \$60 each.

Western Digital Corp., 3128 Red Hill Ave., Box 2180, Newport Beach, Calif. 92663. Phone (714) 557-3550 [365]

# The \$995 Solution to a \$100,000 Problem— Superpac!



Imagine your systems product with an intelligent front-end that combines TTY keyboard layout and CRT with the best industrial microcomputer money can buy. Now dump those scary development cost estimates in the round file. Because it's here today. At a price that's hard to believe! And behind it is the most complete line of standard industrial microcomputer hardware and software available anywhere. Microcomputer and memory boards. Digital I/O. Analog interfaces. Industrial packages. Complete Real-Time Operating System and FORTRAN compiler.

That's what PCS is all about. And that's why we've sold more industrial microcomputers than anyone else in the business.

Please send me more information about  Superpac  
 PCS single-board microcomputers  PCS packaged systems  PCS customer support capabilities.  
 Please have a salesman call.

Name \_\_\_\_\_

Title \_\_\_\_\_

Company \_\_\_\_\_

Street \_\_\_\_\_

City \_\_\_\_\_

State \_\_\_\_\_

Telephone \_\_\_\_\_

Zip \_\_\_\_\_

\*In quantities of 50

**pcs**

PROCESS COMPUTER SYSTEMS, INC.

750 North Maple Road

Saline, Michigan 48176

313-429-4971 TWX: 810-223-8153

Circle 163 on reader service card

# Introducing the Son of "Microprocessors"

Second and third generation microprocessor technology is here, and covered in this new 200 page book "Applying Microprocessors," which picks up where its best-selling predecessor, "Microprocessors", left off. Includes 26 detailed applications from data networks to video games. Indispensable. A *must* for every electronics engineer.



Since the publication of "Microprocessors" only one year ago, enough has happened in the microprocessor revolution to fill a book. That book has just been published.

"Applying microprocessors" is expected to surpass the first book's record sales—over 20,000 copies, now in the fourth printing. The new book completes the engineer's transition from the old methods of electronic design to the new world of microprocessor engineering. The book contains the up-to-date and ready-to-use information that every designer needs to know about the new technology:

Part 1: The hardware. Microprocessors and peripheral devices. Overview of what's available to designers. Descriptions of the latest generation from on-chip devices with erasable memory to 16-bit minicomputer-like devices.

Part 2: Programming and prototype design. Surveys of available software and systems (including in-circuit emulation techniques). Computer-programming approach

to design contrasted with hardware-oriented approach.

Part 3: Actual applications. How the microprocessor is fulfilling the most optimistic hopes for its potential. Detailed descriptions of the ways today's devices already control all types of systems.

The new book focuses on actual applications, with specific how-to-do-it information on 26 applications of the new technology, including . . .

- data networks
- engine temperature monitors
- radar coordinate converters
- teleprinters
- telephone systems
- oscilloscopes
- blood analyzers
- cash registers
- video games
- weighing systems
- analog data processing
- data acquisition systems

## No-risk trial offer

To prove the importance of this book to every engineer, the publishers are making a ten-day trial offer. You must be completely satisfied that the book fulfills its promise or your money will be refunded.

### Electronics Book Series

P.O. Box 669 Hightstown, N.J. 08520

Send me \_\_\_\_\_ copies of "Applying Microprocessors" at \$9.95 per copy.

I must be fully satisfied or you will refund full payment if the book is returned after 10 days trial examination.

Payment enclosed     Bill firm     Bill me

#### Credit Cards Charge My Book To

American Express     Master Charge    Acct. No. \_\_\_\_\_  
 Diners Club     BankAmericard    No. \_\_\_\_\_  
Date Card Expires \_\_\_\_\_ Interbank No. \_\_\_\_\_

1st No's. above name on Mastercharge only.

Name \_\_\_\_\_ Title \_\_\_\_\_  
Company \_\_\_\_\_  
Street \_\_\_\_\_  
City \_\_\_\_\_ State \_\_\_\_\_ Zip \_\_\_\_\_  
Signature \_\_\_\_\_





## New products

Packaging & production

### Bonder puts chips on strips

Manual machine is aimed at thick-film hybrid fabrication

More and more makers of thick-film hybrid circuits are using the film-carrier method of manufacturing, in which chips are bonded to copper patterns on nonconductive film. Ideally, a hybrid house would buy strips of tape and bumped chips and put the chips on tape. Then these and their patterns would be removed from the tape and bonded to a substrate. But small and medium-sized companies have discovered a stumbling block: there has been no commercially available low-cost bonder for applying small quantities of chips to tape.

International Micro Industries, a manufacturer of tapes and bonding machines, decided to close that gap with its model 200 manual inner-lead bonder. It is designed specifi-

cally to put bumped chips on tapes 6 to 12 inches in length. The machine is equipped with a manual tape advance that fits 8-millimeter, Super-8, 16-mm, 32-mm, 35-mm, and 70-mm tapes. Bonding force is adjustable from 1.5 to 100 pounds, and a pulse or a constant-heat bonding head is available. The bonder can handle 200 to 400 chips per hour, regardless of the number of chip leads.

The system comes with either of two chip holders: one for loose chips, the other for a sawed wafer. It also offers a choice of three viewing methods: cable television, microscope, or a high-resolution viewing projector. But, says Thomas Angelucci, company president, the projection viewer is best because it gives a true color image (the TV is monochrome), has a better depth of focus than the TV screen, and eliminates the operator fatigue of the microscope.

Solid-state controls with photocell switching are used in the bonding system. In an actual operation using a strip plus chips, the operator would first align the chip to the reticle in the viewing system, then use the X/Y controls to manipulate the tape fingers over the integrated circuit's

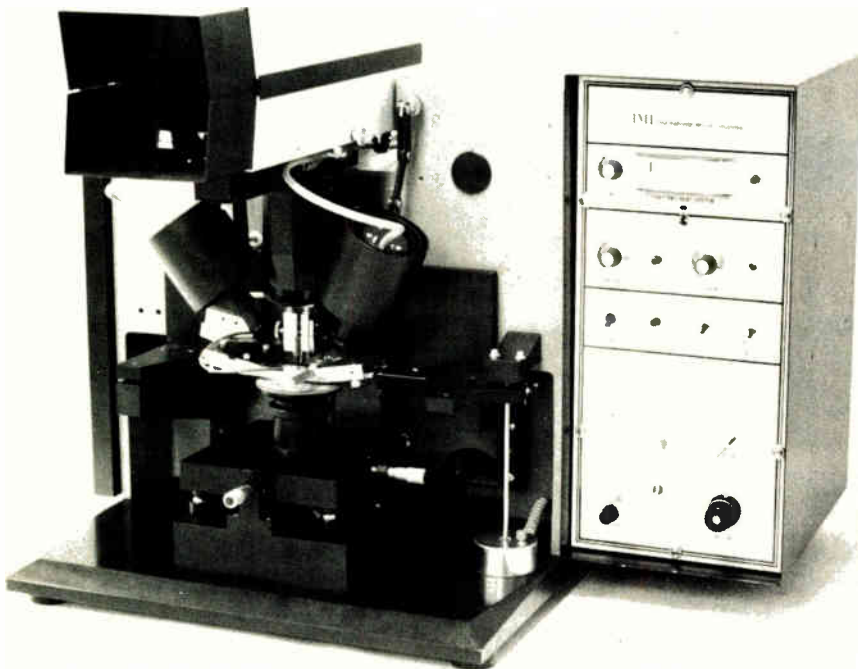

# When you want a small package delivered fast, it's in the bag.



Delta's DASH guarantees delivery on the flight or routing you specify between all Delta cities and most cities served by other airlines through interline agreements. Packages accepted up to 50 lbs. with length plus width plus height not to exceed 90."

Call Delta for an expedited pick-up, or bring your package to Delta's passenger counter at least 30 minutes before scheduled departure time (or to the air cargo terminal at the airport 60 minutes before scheduled departure time). The package can be picked up at the DASH Claim Area next to the airport baggage claim area 30 minutes after flight arrival at destination. Or we deliver it at an additional charge. **DELTA**  
The airline run by professionals

#### Rate examples (Tax included)

Atlanta-Washington . . . . .	\$21.00
Boston-Miami . . . . .	26.25
Los Angeles-New Orleans . .	31.50
Dallas/Ft. Worth-	
Los Angeles . . . . .	26.25
San Francisco-Atlanta . . . .	31.50
Philadelphia-Houston . . . .	26.25
New York-Tampa . . . . .	26.25
Chicago-Orlando . . . . .	26.25
Detroit-Memphis . . . . .	21.00

For full details, call Delta reservations.

For expedited pick-up and delivery at extra charge, call 1-800-424-1092 toll free anywhere in the Delta system. In Washington, D.C. call 466-3131.

## Delta is ready when you are.

## New products

bonding pads. Finally, he pushes a button to automatically bond. After visual inspection, he advances the tape to the next site.

The machine is designed to be upgraded to a semi- or fully automatic version capable of doing 3,000 chips per hour. It measures 36 by 24 by 21 in. and weighs 250 lb. A basic machine costs \$5,950, and the projection viewer costs \$1,450. A pulse heat head costs \$2,450, and the constant temperature head is \$875.

International Micro Industries, P.O. Box 604, Cherry Hill, N.J. (609) 424-3112 [391]

## Unit checks out analog, digital, and mixed circuitry

Thus far, the Capable 4000 line of automatic test systems has been able to handle only digital-circuit boards. Now an option called the model 4707 Analog Capability allows the testers to handle analog and hybrid (mixed analog and digital) circuitry as well.

The model 4707 is a package of hardware and software that can be

added to all existing Capable 4000 testers except the model 4050. Or it can be included as part of a new system. It consists of an IEEE-compatible bus for interfacing analog instrumentation, a four- or five-bus-by-32-pin switching-matrix module, an instrumentation matrix (connecting up to 10 instruments to the analog bus), and a software package that controls both the stimulus and measuring analog instrumentation.

The 4707 system can operate simultaneously in its digital and

# One way...



## HP's Universal Counters

satisfy the needs for most electronic counter measurements up to 1300 MHz, and do it without breaking your budget. Two distinctly different models are loaded with features, and a wide variety of options are available.

**One way is the 5328A** for high performance frequency, period and time interval measurements in a modular 8 or 9-digit unit for systems or bench use. Start with the basic 100 MHz/100 ns unit for just \$1300\*. Modules expand its capabilities to 512 or 1300 MHz for frequency, 10 ns for time interval and add 10 $\mu$ v to 1000v, digital voltage measurements. Other options include ultra-stable time base, and full HP Interface Bus operation. Standard at no extra cost are burst frequency measurement and time interval averaging to

10 ps resolution...matched input amplifiers make this resolution meaningful.

**The other way is the 5300B/5308A System** for lower cost yet highly versatile 8-digit frequency, period and time interval measurements in a modular portable package that also can be rack mounted. In just 30 seconds, snap on any of 10 other modules including: a full capability DMM, battery pack and 1300 MHz and HP Interface Bus modules. The 5300B/5308A's low \$910\* price even includes time interval averaging for resolution to 1 ns!

Use the 10855A Preamplifier for higher sensitivity with any model: 22 dB gain, 2 to 1300 MHz for just \$225\*

**To do it your way** contact your nearest HP field engineer for full data, or write.

\*Domestic U.S. prices only.

analog modes to perform parametric tests on digital circuitry. A dynamic probe is included in the system for guided fault isolation.

The price of the 4707 Analog Capability, not including instrumentation, is \$17,450. Available standard instruments include a multimeter, a 100-megahertz two-channel counter/timer, a function generator, various voltage sources, and a dual load-resistor module.

Computer Automation, 18651 Von Karman, Irvine, Calif. 92713. Phone (714) 833-8830 [393]

System prepares ceramic substrates automatically

The DEK Autofeed 4000 is a completely automatic system for handling, printing, and drying ceramic substrates for hybrid circuits. It works continuously by maintaining reservoirs of substrates at each of its work stations. The substrates are magazine-fed, positioned, printed, ejected, collated, placed on a moving belt, dried or fired, removed from



the belt and replaced in a magazine at a recommended production rate of 1,200 cycles per hour. In addition to

# or the other,



# the right performance at the right price.

HEWLETT  PACKARD

1507 Page Mill Road, Palo Alto, California 94304

For assistance call: Washington (301) 948-6370, Chicago (312) 255-9800, Atlanta (404) 955-1500, Los Angeles (213) 877-1282

Circle 167 on reader service card

# the missing piece in the micro processor puzzle



**low-cost switching  
power supplies**

+5V@6A \$99.  
±12V@1A 100 qty.  
-5V@1A

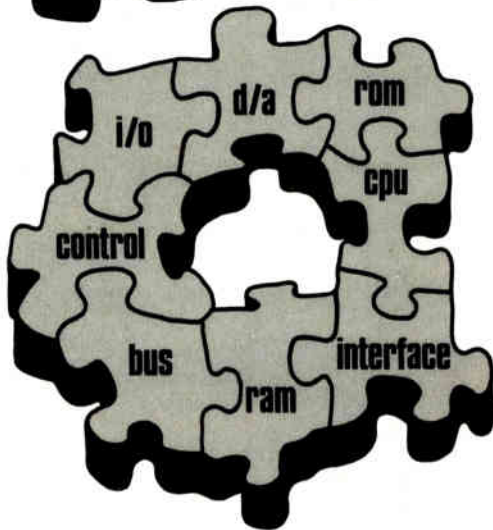

# boschert

*Boschert offers a breakthrough  
in powering microprocessor systems:  
50 watts, 4 outputs, 14 ounces;  
and price-competitive with linears.  
We're the leader in low-cost OEM switchers.*

*Boschert, 384 Santa Trinita Avenue  
Sunnyvale, CA 94086 ■ Phone 408-732-2440*

## New products

printers, the system, which is manufactured in Great Britain, can feed and take up substrates from such other process equipment as bonders, trimmers, reflow solderers, and component-attachment equipment.

Browne Corp., 203 Chapala St., Santa Barbara, Calif. 93101. Phone Michael Ditmore at (805) 963-0371 [394]

Precision ohmmeter  
resolves 0.1 milliohm

Designed for both incoming-inspection and production-line applications, the model PS43PRM precision resistance measuring machine uses a Kelvin circuit configuration to make accurate measurements down to 0.1 milliohm. It is designed to null out lead resistance to make accurate measurements on single- and multiple-layer hybrid circuits, resistor chips, and the like.

The machine can be fitted with a



variety of probe cards and micro positioners. It also contains a vacuum chuck 4.25 inches in diameter that can be fitted with special adapters for holding dual in-line packages. The unit comes equipped with a Kelvin-connected rotary switch for selecting Kelvin-connected probe pairs. Pricing of the PS43PRM depending on configuration ranges from \$2,000 to \$7,000. Delivery of the PS43PRM is from

# Introductory offer to new members of the COMPUTER PROFESSIONALS' BOOK CLUB

any one  
of these great  
professional books  
for only **\$1.89**  
values up  
to \$28.50

Special \$1.89 bonus book comes to you  
with your first club selection

767/653  
**AUTOMATA THEORY**  
An Engineering Approach  
by I. Aleksander and F. K. Hanna  
Pub. price, \$15.50  
Club price, \$13.15

768/803  
**DATA COMPRESSION**  
by L. D. Davission and R. M. Gray  
Pub. price, \$25.00  
Club price, \$17.95

767/017  
**COMPUTER INTERFACING AND ON-LINE OPERATION**  
by J. C. Cluley  
Pub. price, \$14.50  
Club price, \$12.35

766/053  
**SYSTEMS SIMULATION**  
Methods and Applications  
by A. M. Colella, M. J. O'Sullivan and D. J. Carlino  
Pub. price, \$16.00  
Club price, \$12.95

768/528  
**DATA PROCESSING SYSTEMS ANALYSIS AND DESIGN**  
by R. J. Condon  
Pub. price, \$13.50  
Club price, \$10.75

768/17X  
**BENCHMARKING**  
Computer Evaluation and Measurement  
by N. Benwell  
Pub. price, \$19.95  
Club price, \$14.95

768/498  
**DIGITAL SYSTEM DESIGN AUTOMATION**  
Languages, Simulation and Data Base  
by M. A. Breuer  
Pub. price, \$18.95  
Club price, \$15.95

435/278  
**MICRO-PROCESSOR APPLICATIONS MANUAL**  
by Motorola Semiconductor Products, Inc.  
Pub. price, \$28.50  
Club price, \$22.50

767/009  
**DIGITAL SIGNAL PROCESSING**  
by A. V. Oppenheim and R. W. Schaffer  
Pub. price, \$22.95  
Club price, \$18.95

768/307  
**CONTENT ADDRESSABLE PARALLEL PROCESSORS**  
by C. Foster  
Pub. price, \$11.95  
Club price, \$ 9.95

767/262  
**ENGINEERING CYBERNETICS**  
by R. M. Glorioso  
Pub. price, \$16.95  
Club price, \$13.95

766/770  
**MINICOMPUTER SYSTEMS**  
Structure, Implementation and Applications  
by C. Weitzman  
Pub. price, \$19.50  
Club price, \$14.50

768/749  
**MICRO-PROCESSOR/MICRO-PROGRAMMING HANDBOOK**  
by B. Ward  
Pub. price, \$9.95  
Club price, \$8.45

767/661  
**INTERACTIVE COMPUTER GRAPHICS**  
by B. S. Walker, G. R. Grund and E. A. Drawneck  
Pub. price, \$14.50  
Club price, \$12.30

## save time and money by joining McGraw-Hill's new COMPUTER PROFESSIONALS' BOOK CLUB



**T**HIS new professional club is designed to meet your day-to-day on-the-job needs by providing practical books in your field on a regular basis at below publisher prices. If you're missing out on important technical literature—if today's high cost of reading curbs the growth of your library—here's the solution to your problem.

The Computer Professionals' Book Club was organized for you, to provide an economical reading program that cannot fail to be of value. Administered by the McGraw-Hill Book Company, all books are chosen by qualified editors and consultants. Their understanding of the standards and values of the literature in your field guarantees the appropriateness of the selections.

How the Club operates: Every month you receive free of charge *The Computer Professionals' Book Club Bulletin*. This announces and describes the Club's featured book of the month as well as alternate selections available at special members' prices. If you want to examine the Club's feature of the month, you do nothing. If you prefer one of the alternate selections—or if you want no book at all—you notify the Club by returning the card enclosed with each *Bulletin*.

As a Club Member, you agree only to the purchase of four books (including your first selection) over a two-year period. Considering the many books published annually, there will surely be at least four you would want to own anyway. By joining the club, you save both money and the trouble of searching for the best books.

### MAIL THIS COUPON TODAY

COMPUTER PROFESSIONALS/Book Club  
P.O. Box 582 Princeton Road, Hightstown, New Jersey 08520

Please enroll me as a member and send me the two books indicated. I am to receive the bonus book at the introductory price of \$1.89 plus my first selection, plus tax, postage and handling. If not completely satisfied, I may return the books within 10 days and request that my membership be cancelled. If I keep the books, I agree to take a minimum of three additional books during the next two years at special Club prices (guaranteed 15% discount, often more). I will receive the Club bulletin 12 times a year. If I want to examine the featured selection, I need take no action. It will be shipped automatically. If, however, I want an alternate selection—or no book at all—I simply notify the Club by returning the convenient card always enclosed. I will always have a minimum of 10 days in which to return the card and you will credit my account fully, including postage, if this is not the case. Membership in the Club is continuous but cancellable by me at any time after the four-book purchase requirement has been filled. This order subject to acceptance by McGraw-Hill. Orders from outside the continental U.S. must be prepaid. Company, business, or institutional tax exemption status is not applicable to purchases made through individual Club memberships. All prices subject to change without notice. Offer good for new members only.

Write Code # of \$1.89 bonus book selection here

Write Code # of first selection here

NAME

ADDRESS

CITY

STATE  ZIP

EXTRA SAVINGS: Remit in full with your order, plus any local and state tax, and McGraw-Hill will pay all postage and handling charges. **P39197**



**... IN CELEBRATION OF NEWLY DEVELOPED THICK FILM PASTES, THAT HAVE BEEN INSTRUMENTAL IN EXPANDING THE STATE OF THE ART SINCE 1972.**

**POWEROHM®**  
Resistor Pastes • High Performance Formulas  
• 3 Different Firing Temperatures • Contains PARTILOX® Assuring Control of Paste Rheology on the Screen.

**CONDUCTROX®**  
Conductor Pastes • Screen Printable  
• Paste Rheology is Controlled in Storage and During Screening • Conductor Pastes include Silver/Alloy, Gold/Alloys and Non-Noble Metals.

**SILICA-SEAL®/ISO-OHM®**  
Dielectric Pastes • Crossover—Multilayer—Overglaze—Sealing • Low Temperature Fast Firing • Color Series Identifies Specific Layers, Crossovers, Components and Circuits.

**THICK FILM SYSTEMS, INC.**  
324 PALM AVE., SANTA BARBARA, CA 93101 (805) 963-7757

SUBSIDIARY OF

**TECKNIT** CRANFORD, NJ 07016 SANTA BARBARA, CA 93101  
(201) 272-5500 (805) 963-1867

AND TO THE PEOPLE WHO DEVELOPED THE CONNECTOR

**ZEBRA®**  
Conductive Elastomeric Connector Elements  
• Long Life Reliability • Environmental Seal  
• Provides Low Profile Packaging  
• No Soldering Necessary.



Circle 170 on reader service card

## PINPOINT HEAT

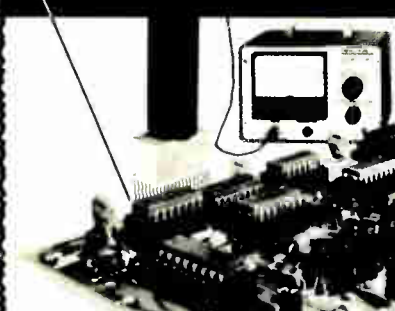

Heat any integrated circuit or electronic component to its rated temperature with a heat probe. Accuracy  $\pm 3^{\circ}\text{C}$  or better. Or check the component's temperature with a thermo-couple probe. Model 810 Thermo-Probe does both. Reads out directly in  $^{\circ}\text{C}$  and  $^{\circ}\text{F}$  on a large  $4\frac{1}{2}$ -inch meter.

Models with other temperature ranges available. For details write to:

**MTI MICRO-TECHNICAL INDUSTRIES**  
P.O. Box 287 South Laguna, CA 92677  
(714) 545-3734 • TWX 910-587-3425 MICRO OHM ELM

Circle 213 on reader service card

## PROFESSIONAL DISCOUNTS

Texas Instruments electronic calculator

Ti-30	\$21.95	SR-51-II	56.95
1600	21.95	SR-56	84.50
1650	26.95	SR-52	189.95
2550-II	28.50	PC-100	159.95
SR-40	32.50	Ti-5050M	89.95
Bus Anst	32.50	5040-PD	114.95
5100	49.95	Money Mgr	21.95
Libraries	24.00-39.95		
Little Prof (2 min)	16.95		

(No credit cards)

**HEWLETT HP PACKARD**

HP-21	\$71.00	HP-27	\$154.00
HP-22	109.95	HP-25C	175.00
HP-25	127.60	HP-67	395.00
		HP-97	664.95

**NOVUS NATIONAL SEMICONDUCTOR**

Quiz Kid II	\$17.95	Statistician PR 6035	\$32.50
Math 4510	16.95	NS-852	24.95
Scientist 4520	29.95	NS-4515 PR	32.50
Scientist PR4525	54.95	NS-4640	49.95
Financier 6020	26.45	NS-4650	39.95
Statistician 6030	26.45	NS-4660	49.95
Financier PR6025	32.50	Adversary TV Game	74.95

In Calif. call (213) 370-5795 or ORDERS ONLY CALL (800) 421-0367 (other than CA.) Send money order. Pers. ck (2 wks. to clear); in CA. add 6% sales tax. Add \$3.50 min. shipping charges US only; \$7.00 for SR-52, PC-100, HP-67, -97. Canada min. shipping charges \$6.50. WE SHIP UPS AIR. Send mail orders to DEPT. EL-C.

**tkenterprises**  
BETTER BUSINESS PRODUCTS  
16611 HAWTHORNE BLVD., LAWDALE, CA 90260  
(213) 370-5795

Circle 214 on reader service card

## New products

stock to as much as four weeks.  
Probe-Rite Inc., 2725 Lafayette St., Santa Clara, Calif. 95050. Phone Frank Ardezzone at (408) 249-1255 [395]

Modular wire-wrap panels can hold 192 DIPs each

A family of modular wire-wrap panels and frames provides high-density packaging for as many as 192 dual in-line packages. The panels are particularly suited for use with microprocessors, random-access memories, read-only memories, and other integrated circuits that require large numbers of input/output lines. A total of 540 I/O lines is available per panel. They may be mated with wire cable assemblies for connection to other panels. The panels contain inter-pin ground planes for high-speed operation and high noise immunity.

The panels, which can handle all ICs, from 8-pin to 42-pin, are priced from \$350 each in lots of 10 pieces. Frame prices, for similar quantities, start at \$16 each.

Mupac Corp., 646 Summer St., Brockton, Mass. 02402. Phone (617) 588-6110 [396]

Zero-force stacking connectors are compact

Intended for microprocessor applications, a line of zero-insertion-force stacking connectors requires only 0.5-inch mounting width. Capable of stacking printed-circuit boards from 0.060 to 0.093 in. thick on 0.6-in. centers, the connectors have post contacts on 0.100-by-0.100-in. grid spacing to mate with each other or with several standard varieties of other connectors. The gold-plated contacts have posts with 0.025-in.-square tails for solderless wrapping.

The activating mechanism requires 0.420 in. of linear travel to make contact or release the connectors. It has a life expectancy in excess of 5,000 mating cycles.

AMP Inc., Harrisburg, Pa. 17105. Phone (717) 564-0100 [397]

Electronics/March 3, 1977



**WIRE WRAPPING TOOL**

For AWG 30, .025" (0,63mm) sq. post,  
"MODIFIED" wrap, positive indexing,  
anti-overwrapping device

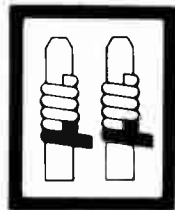

**OK MACHINE & TOOL CORPORATION**

3455 Conner St., Bronx, N.Y. 10475 / (212) 994-6600 / Telex 125091

**NEW**

**HOBBY-WRAP  
Model BW-630**



**Battery  
wire  
wrapping  
tool**

**\$34<sup>95</sup>**  
ONLY (batteries  
not included)  
**COMPLETE WITH BIT  
AND SLEEVE**

**NEW**

**HOBBY-WRAP  
Model BW-630**



**Battery  
wire  
wrapping  
tool**

**\$34<sup>95</sup>**  
ONLY (batteries  
not included)  
**COMPLETE WITH BIT  
AND SLEEVE**

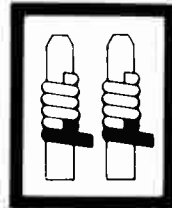

**WIRE WRAPPING TOOL**

For AWG 30, .025" (0,63mm) sq. post,  
"MODIFIED" wrap, positive indexing,  
anti-overwrapping device.



**OK MACHINE & TOOL CORPORATION**

3455 Conner St., Bronx, N.Y. 10475 / (212) 994-6600 / Telex 125091



# PHILIPS



## Cash in with us.

Times have changed.

Today's market demands a labour-saving integrated system for recording sales data. A complete system in which data are automatically registered on cassette at the point of sale. The Philips Data Logger is a vital part of such a system.

The Philips Data Logger is based on the Philips digital cassette recording system which is already proved in many different data-recording applications, and meets ECMA-34 specifications.



The Data Logger can be interfaced with electronic cash register systems currently in use or under development. Sales data recorded on cassette can

conveniently and economically be processed by computer to meet all accounting requirements.

Cash in on the electronic cash register market with the Philips Data Logger. It makes electronic cash register systems complete.

For information about the Philips Data Logger or other cassette data-recording applications, contact:

N.V. Philips' Gloeilampenfabrieken  
Digital Recording Department HBS-2  
Eindhoven The Netherlands  
Tel 040-756935 or 757461



## New literature

**Transformer design.** A 24-page catalog and engineering handbook covers many phases of transformer design. A separate section tells how to specify a transformer and includes a checklist specification sheet, which, when completed, provides all the information needed to design a transformer for a particular application. Copies of the publication are available from Inglot Electronics Corp., 4878 N. Elston Ave., Chicago, Ill. 60630. Circle reader service number 421.

**Switch approvals.** Designed to give international marketers a working knowledge of switch-testing methods in various countries, a 16-page handbook covers such topics as specifications, markings, creepage, clearance distances, and electrical-life requirements for snap-action switches. Copies of *A Handbook of International Switch Approvals* may be obtained by sending \$2 to F. Amendola, Cherry Electrical Products Corp., P.O. Box 718, Waukegan, Ill. 60085.

**Solid-state relays.** A comprehensive applications handbook for solid-state relays includes circuits and block diagrams for a wide variety of commercial/industrial and military-aerospace subsystems. Copies of the 24-page handbook may be obtained from Teledyne Relays, 3155 W. El Segundo Blvd., Hawthorne, Calif. [423]

**Microwave semiconductors.** The line of receiving diodes, control diodes, power-generating devices, and amplifying

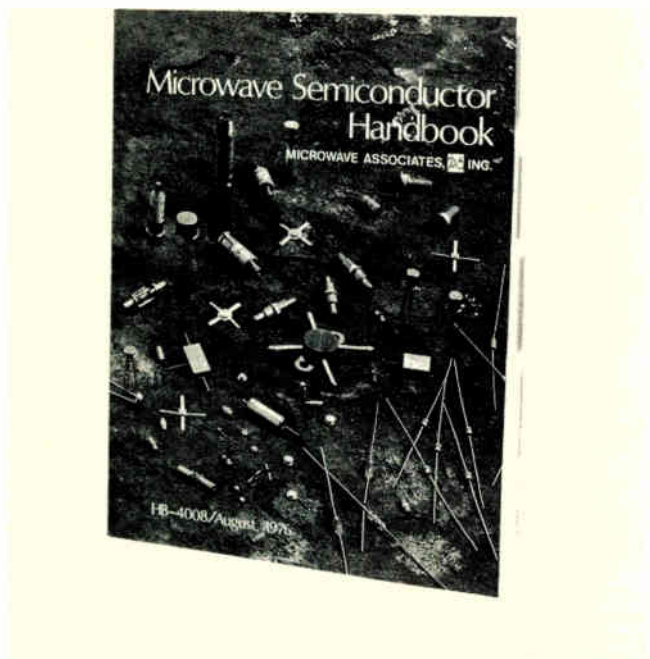

devices made by Microwave Associates Inc. is covered in a 256-page handbook that can be obtained from the company on South Ave., Burlington, Mass. [426]

## How do you resolve two signals spaced 1 Hz apart at 2 MHz?

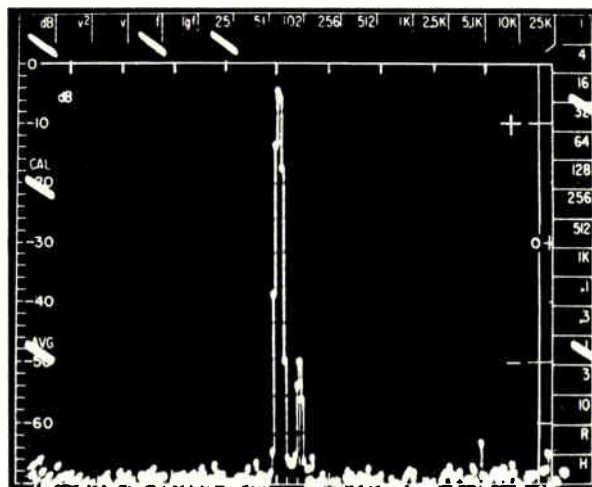

With an EMR Model 1510 Digital Real-Time Spectrum Analyzer and EMR Model 1520 Digital Spectrum Translator. Simply add the optional EMR Model 1521 Range Extension Module to the 1520 Translator, and you have real-time spectrum analysis at frequencies up to 2 MHz!



The CRT photograph illustrates the result. The input signal consisted of two discrete frequencies spaced 1.0 Hz apart, with a 50 dB difference in amplitude. The frequency range covered is 25.6 Hz centered about 1.990000 MHz, and the frequency resolution is 0.1 Hz!

Only EMR offers that much resolution at frequencies up to 2 MHz in real time.

So if you have an analysis problem requiring high-resolution/high-frequency real-time spectrum analysis, contact EMR . . . we will arrange for a demonstration or detailed information.

Sangamo Weston, EMR Telemetry Division  
P.O. Box 3041, Sarasota, FL 33578  
813-371-0811

**SANGAMO WESTON**  
**Schlumberger**

# Classified section FOR ENGINEERING/TECHNICAL EMPLOYMENT OPPORTUNITIES

**CLASSIFIED SALES REPRESENTATIVES**  
 Atlanta... Joe Lane... 404/892-2868  
 Boston... Holt Buchanan... 617/262-1160  
 Chicago... Bill Higgins... 312/751-3733

Cleveland... Mac Huestis... 216/781-7000  
 Dallas... Mike Taylor... 214/742-1747  
 Denver... Shirley Klotz... 303/837-1010  
 Detroit... Mac Huestis... 313/873-7410

Houston... Mike Taylor... 713/659-8381  
 Los Angeles... Stan Kassir... 213/487-1160  
 New York... Dave Hawksby... 212/997-3594  
 Philadelphia... Dan Ferro... 215/568-6161

Pittsburgh... Dan Ferro... 412/391-1314  
 San Francisco... M.E. Kenny... 415/362-4600  
 Stamford... Holt Buchanan... 203/359-2860  
 XEROX 400 TELECOPIER... 212/997-6800

## ENGINEERS NEW 1977 OPPORTUNITIES MOS SEMICONDUCTORS

We could list the new vacancies we have for 1977, but that doesn't tell the real story. The real story is an expanded Research and Development effort, new directions in packaging and assembly techniques, and advanced Q.A. involvement in qualifying new circuits for transfer to production.

We could list the products we have already developed (custom or standard). That would be past history for us; for others it would be products still to be achieved and wanted. However, we are interested in you and what you want to do as an engineer. You have spent many years in school. If you are experienced, you have learned things to apply—new concepts not compatible in your present circumstance. Either new graduate or experienced engineer, you are ready for a step up in responsibility. NCR could have the circumstance that will satisfy your need to work at what you are prepared for and help us meet the demanding objectives we have in 1977:

- **MNOS**—P and N channel; continual yield improvement, new process techniques, new equipment evaluation
- **Device Design**—Microprocessors, non-volatile memories, electrically alterable devices for use in mass memory applications
- **Reliability**—New packaging techniques and processes; automated assembly and data collection, new product transfer

So, to maintain the excellent performance we have achieved and to do the new things we have set for ourselves, we still need more people!

We will consider all applicants. We do require an appropriate degree (BS, MS or PhD) in Electrical Engineering or Engineering Physics. We will make our offers to those qualified to represent an increase in responsibility. Tell us about your experience and your personal objectives. What are you ready for that you are not doing? Write in confidence to:

**T. F. Wade, Manager  
 Personnel Resources  
 Microelectronics Division  
 NCR Corporation  
 8181 Byers Road  
 Miamisburg, OH 45342**



An Equal Opportunity Employer

PROBE-TECH

Specialists in Electronic & Semiconductor Recruiting.

### Semiconductor Engineers

We have been retained by several leaders in the Semiconductor industry to locate talented engineers with a desire to move ahead.

Companies are located on Westcoast, The Midwest, New England and Southern coastal region. Most are Fortune 500 companies and offer the advantages of major universities, challenging career development and financially rewarding position. 1 year experience plus degree required.

- \* **Marketing Engineer (Bipolar Memory)**
- \* **Microprocessor Applications Engineers**
- \* **Bipolar Designers (Digital, Linear)**
- \* **Facilities Manager**
- \* **New Product Dev. Engineer (Semiconductor Equipment)**
- \* **Engineering Manager (Semiconductor Manuf. Equipment)**
- \* **Product Engineers (Bipolar linear)**
- \* **Thin Film Engineer (T.F. Resistor Sputtering Exp.)**
- \* **Assembly/Pkg. Engineers (Autobonding, Bipolar)**
- \* **I. C. Test Engineers**
- \* **Memory Designers (Bipolar, Mos, Cmos)**
- \* **Process Engineers (Diffusion, Deposition, Metalization, Crystal Growing)**
- \* **Reliability Engineers**
- \* **Product Engineering Manager (Bipolar Linear)**
- \* **CCD Designer**
- \* **MDS Microprocessors, Designers (N-Chan. Silicon gate)**
- \* **Circuit Designer (Linear & IC)**
- \* **Microprocessor System Engineers (Soft/Hardware)**
- \* **Senior MDS Development Engineer (N/Chan. MOS Structure)**
- \* **Facilities Director**
- \* **Test Manager (Microdata, IC)**
- \* **Test Manager (Teradyne, LSI)**
- \* **Product Engineer Manager (Microcomputer)**

Do any of these positions kindle an interest for more details? Then call (Person-Person) to Denny Frye (314)285-3131, or rush Resume to:

## Probe-Tech

Semiconductor Div.

P.O. Box 97, Morse Mill, Mo. 63066

500 Electronics Companies  
 Are Waiting To See Your Resume

\$16-30K

Just Mail It With Present Salary To

P'n B CONSULTANTS, BOX 261, WAYNE, PA 19087  
 THE ENGINEERS WHO TALK YOUR LANGUAGE  
 WE'LL BE IN TOUCH WITH YOU.

### DIGITAL/ANALOG DESIGN ENGINEER

Salary area, \$13,000 to \$24,000

Houston's manufacturers of digital/analog systems, micro-processors and mini computers are expanding their products and markets and are in urgent need of Digital Design Engineers. Salaries range from \$13,000 to \$24,000 DOE.

For further information, contact Warren Dunn at (713) 621-9050.

ALL FEES ASSUMED BY CLIENT COMPANIES

M. David Lowe  
Personnel Services Inc.  
420 Houston Natural Gas Bldg.  
Houston, Texas 77002

### POSITIONS WANTED

Experienced Product Innovator and Engineering Administrator—Fifteen patents, several successful products and various publications. Admin. experience includes OD, product planning, resource allocation, etc. Searching for rapid growth or turn-around situation. Objective is to make meaningful contribution to significant technical programs. Ideally to participate in "State of the Art" advances in controls, instrumentation, or EDP technologies. PW-4051, Electronics.

### OVERSEAS JOBS GUIDE

Job Hunters Guide & Directory of 600 firms. \$6.00 +\$.50 P&H (US \$ check or MO only). foreign—add \$2.00. Friar Books, Dept EL, 8956 E Ardenale, San Gabriel, CA 91775.

## Schlumberger

MESURE ET REGULATION EUROPE

LA DIRECTION DES ETUDES ET RECHERCHES  
RECRUTE POUR SON LABORATOIRE CENTRAL

### UN INGENIEUR CONCEPTEUR EN CIRCUITS INTEGRES

pour étude et conception de circuits LSI

- ayant fait preuves en étude et conception de circuits LSI monopolaires et bipolaires.
- intéressé par la conception de produits nouveaux à fabriquer en grande série.
- ayant une connaissance approfondie de la technologie des semi-conducteurs. Ce poste constitue une opportunité de participer au démarrage d'une activité nouvelle pour la Société. Anglais souhaité.

### UN INGENIEUR D'ETUDE EN ELECTRONIQUE

- ayant une expérience d'environ 5 ans des circuits analogiques et digitaux - si possible - dans le domaine de la mesure.
- ayant fait ses preuves dans des conceptions novatrices et capable de mener de front des études sur plusieurs lignes de produits.
- désireux de mener des études théoriques en électronique et à les mettre en application.

Ce poste nécessite un esprit créatif - Anglais souhaité.

Seuls des candidats de tout premier plan seront retenus pour ces postes : si vous pensez être cette personne, envoyez votre candidature et votre C.V. avec photo à

SCHLUMBERGER MESURE ET REGULATION EUROPE  
Direction du Personnel  
12, place des Etats Unis, 92120 MONTRouGE

## NOW IS THE TIME ... TO HIRE A STUDENT THIS SUMMER.

First, it's later than you think, with schools closing on different semester schedules, and students torn between lining-up "sure" jobs now or gambling that something in their chosen field will come along later.

Second, and most important, it's in our industry's best interest to encourage and hold its life-blood by providing practical experience in their future profession.

And, since there'll always be more applicants than openings, you'll be able to select the cream of the crop, then evaluate them with an eye towards hiring, when

as coveted graduates, the job market might well be in their favor.

Because we believe this program is of mutual benefit to both employer and employee alike, we again offer our services as a clearing-house.

Just fill out and return the coupon below, and we'll include your organization in a free listing to be sent to Placement Directors and Department Heads at leading colleges and universities across the nation. They'll post it, and the students will contact you directly.

### Free summer help listing

MAIL TO: ELECTRONICS/POST OFFICE BOX 900/NEW YORK/NY 10020

NAME/TITLE (of individual to be contacted)

ADDRESS: (Mailing address of your personnel office)

ORGANIZATION: (Firm, Company, Government Agency or Institution)

TYPE AND NUMBER OF STUDENTS SOUGHT: Electronics Avionics

Technician Other: (Draftsman, etc.)



3/3/77

Note: Last date coupons can be accepted for this year's student mailings is 4/15/77.

## WHAT ARE YOU WORTH?

In today's job market, that is. One way to see if you're in demand is to check the employment opportunities contained in ELECTRONICS' Classified Section.

Another way to get a reading on your value is to place a blind (box number) Position Wanted ad there. The cost is low (only \$1.25 per line) and the results are often rewarding.

For more information call or write:

## ELECTRONICS

Post Office Box 900  
New York, N.Y. 10020  
Phone: 212/997-2556

## Electromechanical Project Leader

This position will participate in the technical planning and design of new and modified electrical electronic switching components. Responsibility includes technical supervision and administration for engineers, technicians, and draftpersons in the design group.

Background should include two to five years experience in switch design and a BS or equivalent experience, an electrical background and/or supervisory experience is desirable.

Tektronix, Inc., develops, manufactures and markets internationally recognized precision electronic measurement instruments, computer peripherals and related electronic instrumentation. Located near Portland, Oregon, we are within a two hour drive of the Cascade Mountains or Ocean Beaches. The close-by nature playgrounds and the City of Portland provide a variety of recreational and cultural interests.

Salary is open. Benefits include liberal educational support, insurance and profit sharing programs.

Please send detailed resume and salary history to: Roy Epperson, TEKTRONIX, INC., P.O. Box 500, E28, Beaverton, Oregon 97077. An Equal Opportunity Employer M/F.



**TEKTRONIX®**  
committed to  
technical excellence

Electronics

## SR. ELECTRONICS DESIGN ENGINEER

### DIGITAL SYSTEMS DEVELOPMENT

We're a leading midwest manufacturer of automated banking and security systems utilizing state-of-the-art electronics technology, well-known for our achievements in EFT equipment and proud of our reputation for continuous growth. Our on-going commitment in digital systems development has created this challenging opportunity for a self-motivated Sr. Electronics Design Engineer.

Selected candidate will assume project level responsibility for the leadership and coordination of engineering and firmware development of automated terminals and communication control systems for the banking industry.

A BSEE or equivalent coupled with 4-6 years solid experience in digital systems design and development are essential. Candidates' background must reflect a proven capability in the design of microprocessing and minicomputer systems in the data communications field and an ability to work well as a key member of multiple discipline technical development teams.

The selected candidate will realize outstanding potential for career growth, professional advancement and industry recognition. Submit letter or resume, in confidence, outlining salary history to:

Diebold Inc.  
Canton, Ohio 44711  
Attn: C. J. Maurer

An Equal Opportunity Employer M/F

**DIEBOLD**  
INCORPORATED

## Doesn't Your Career Deserve the Best?

We are a Phoenix-based computer electronics company that is young, aggressive, and well-financed offering worldwide sales and service. We need talented, ambitious people in engineering, manufacturing and finance. Our corporate growth and new expansion is showing a 50% increase per year and we would like to have you assist us in continuing this outstanding growth pattern. Currently, openings exist at all levels and we invite you to learn more about working with Courier.

Please send resume to: Mr. R. Sippei

### Courier Terminal Systems

2202 E. University Drive  
Phoenix, Arizona 85034  
an equal opportunity employer m/f

**RATES** \$46 per advertising inch (7/8"). Commissionable.  
**SIZES** 7/8" to 10" deep in widths of one column (1 1/8"), two (3 3/8"), three (5 1/8"), and four (7").  
**CLOSING** Two weeks prior to mailing.  
**MAILING** One week prior to issue date.  
**ISSUE DATE** Every other Thursday.  
**AD ORDERS/BOX NUMBER ANSWERS** Send to Electronics, Post Office Box 900, New York, N.Y. 10020.

## Electro-optics, Optomechanics, Infrared, Laser, Computer Hardware Development, Radar

**The professionals:** EEs, physicists

**The tasks:** advanced and conceptual design; electro-optical sensor analysis; performance analysis; advanced image and signal processing; stabilization/tracking analysis; systems design, including space-based programs; circuit design that uses MOS or bipolar; design of CCDs and microprocessor/microcomputer techniques.

**The professionals:** EEs, physicists, MEs

**The tasks:** device development; high-energy-laser alignment-control systems; servos; precision gimbals and mechanisms.

**The professionals:** EEs

**The tasks:** computer-controlled test equipment and system integration and checkout, including systems design and application.

**The professionals:** radar circuit designers

**The tasks:** analog or digital circuit design and development; radar transmitters; RF subsystems—all using RF power-amplifier components/subsystems, modulators, high-voltage power processing, and control/protection circuits and techniques.

**The professionals:** radar systems engineers

**The tasks:** systems design using Fourier analysis, pattern recognition, and radar signal processing using digital techniques.

Degree from an accredited institution required. Please send resume to: Professional Employment, Hughes Aircraft Company, 11940 West Jefferson Blvd., Culver City, CA 90230.

# HUGHES

HUGHES AIRCRAFT COMPANY  
AEROSPACE GROUP

US citizenship required  
Equal opportunity M/F/H/C employer

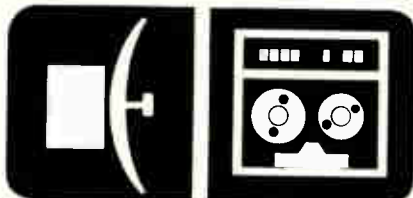

**ARINC**

## PROJECT MANAGERS SYSTEM ENGINEERS/ ANALYSTS

### SHIPS SYSTEMS TELECOMMUNICATIONS SYSTEMS AVIONICS & MECHANICAL SYSTEMS

#### CURRENT POSITION LOSING ITS CHALLENGE? REJUVENATE YOUR CAREER!

You've Got Your Basic Experience—Now Use It To Full Advantage With A Firm That:

#### RECOGNIZES AND REWARDS PERFORMANCE

ARINC RESEARCH CORPORATION, A Leading, Rapidly Expanding Consulting And Engineering Research Firm Offers You A Career Filled With CHALLENGING ASSIGNMENTS, And A Thoroughly PROFESSIONAL ATMOSPHERE, With Continuous OPPORTUNITIES For CAREER ADVANCEMENT.

#### POSITIONS NOW AVAILABLE IN MARYLAND AND CALIFORNIA

Responsibilities Will Involve:

ILS Planning  
Systems Modeling  
Trade-Off Analysis  
System Test Planning  
Design-To—Cost Analysis  
Life-Cycle Cost Analysis  
Operational Research Analysis  
Reliability/Maintainability Analysis

If You Are Aggressive, Goals-Oriented And Enjoy Working In A Fast-Moving Results-Oriented Environment, Then Please Submit A Resume INCLUDING SALARY REQUIREMENTS To E. J. Wall

(U. S. Citizenship Required)

**ARINC**  
RESEARCH CORPORATION  
2551 Riva Road  
Annapolis, Maryland 21401  
An Equal Opportunity Employer M/F



# Lead the Way!

Long term design and development projects

## SIGNAL PROCESSING DESIGN ENGINEERS

This position requires a BSEE or equivalent plus 8-15 years' diversified experience in DIGITAL LOGIC DESIGN with emphasis on SIGNAL PROCESSING techniques. Your background should include leadership responsibility in the development of complex equipment design and a thorough knowledge of DIGITAL HARDWARE. You should have recent experience in one or more of the following disciplines: RADAR PRINCIPLES, TIMING CODING/DECODING, FORMATTING, DATA TRANSFER and CONTROL LOGIC, including Worst Case Analysis.

## DIGITAL DESIGN ENGINEERS

You will need a BSEE or technical degree in a related area plus 3-7 years' experience in GENERAL PURPOSE LOGIC DESIGN using high speed integrated circuit logic devices and familiarity with state-of-the-art digital devices and computer aided design techniques. You should also have experience in DIGITAL CIRCUIT DESIGN, including A/D and D/A Converters and Worst Case Design.

## MICROWAVE DESIGN ENGINEERS

You will be responsible for conceptual definition, design and development of microwave circuits and components necessary in the DESIGN OF ANTENNAS including PHASED-ARRAYS. Knowledge of advanced techniques in computer applications for analysis and control is essential.

If you meet the qualifications for one or more of these disciplines, we would like to arrange a personal meeting with one or more of our client's senior engineers or department heads. Please send your resume, including salary history, in confidence to LRK ASSOCIATES, 6845 Elm Street (EL-4), McLean Virginia 22101. U.S. CITIZENSHIP REQUIRED. Representing an Equal Opportunity Employer M/F/H.



**LRK**  
ASSOCIATES

## DESIGN ENGINEERS INVENTORS

Manufacturer with USA & Int'l. commercial industrial sales staff has available venture capital, R&D team for production, packaging, marketing your product design. Royalty or proprietorship basis. Send preliminary particulars to

RA-4138 Electronics  
Class. Adv. Dept. P.O. Box 900  
N.Y., N.Y. 10020

## We have been placing graduate ENGINEERS



in FEE-PAID positions  
THROUGHOUT THE U.S. since  
'59. Over 1,000 client companies.  
We are graduate engineers work-  
ing full-time for you. Send resume  
& salary history today or request  
confidential application.

**ATOMIC PERSONNEL, INC.**

Suite L 1518 Walnut St., Phila., Pa. 19102  
An Employment Agency  
For All Technical Fields

## POSITION VACANT

**Electronics Engineers—All Dis-**  
ciplines, Microwave, Analog, Digital,  
Circuitry, Instrumentation and Con-  
trols, openings nationwide for design,  
applications and sales. \$14-40K, Fee  
Paid. Write, in confidence, to Mr. C.  
Robin, P.E., Dunhill Tech Search, 182  
Forbes Road, Braintree, MA 02184,  
617-848-6320.

**Engineers/Scientists: Over 800 firms**  
in Eastern U.S. pay our fees to  
recruit Top-Caliber professionals in  
all technical areas. Send detailed  
resume, in confidence. Wallach  
Associates, Inc., 1010 Rockville  
Pike, Rockville, MD 20852.

## BUSINESS OPPORTUNITY

**How To Earn Money As A Consultant**  
(including specimen contracts) \$16  
Business Psychology Int'l 2407/44  
Pacific Virginia Beach, Va. 23451.

## STILL LOOKING FOR YOUR DREAM JOB?

Then be sure to check out the employment opportunities contained in ELECTRONICS' Classified Section.

Or, why not consider placing a Position Wanted ad? The cost is low (only \$1.25 per line) and the results are often rewarding. For more information call or write:

**ELECTRONICS** Post Office Box 900  
New York, N.Y. 10020 • Phone: 212/997-2556



# LSI TECHNICAL SPECIALISTS CIRCUIT DESIGNERS TEST ENGINEERS

## Enjoy the good life in Florida ...with a rewarding future at the ITT LSI Systems Support Center

This recently established, corporate-funded organization is located in West Palm Beach, where the year-round living is all you could ask for. The career opportunity is the ideal complement, because this Center is charged with providing the means for optimum use of LSI in wide-ranging ITT telecommunications, space, defense, automotive and industrial product areas. This scope and challenge dictate the building of a highly qualified, technology oriented, system sensitive professional staff. True ground-floor positions with unusual reach into the future, offering excellent prospects for career advancement, are available to those who qualify.

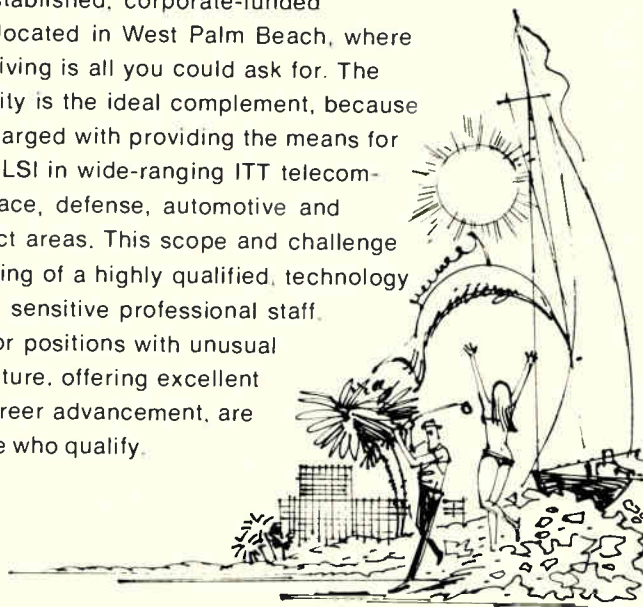

### Technical Specialists

Technical expert in advanced large-scale integration. Responsible for interface with ITT equipment and systems divisions in development of new state-of-the-art applications, from LSI studies through chip design to volume manufacturability. Requires MSEE and minimum 4 years LSI design experience.

2 years design experience using sophisticated computer-aided techniques.

### Senior Test Engineers

Interface with ITT equipment and systems divisions in testing philosophy and testability for new applications. Generate and debug test and characterization programs for custom and standard LSI circuits. Requires BSEE and 4 years in product and test engineering. Sentry experience and knowledge of MIL-38510 qualification techniques preferred.

Positions also available at lesser experience levels.

### Circuit Designers

Experienced designer in advanced LSI technologies. Responsible for design of complex LSI circuits in latest bipolar and MOS technologies. Requires BSEE and

If interested and qualified, please send your resume in confidence to Mr. Robert VerNooy, Personnel Manager, ITT LSI Systems Support Center, 3301 Electronics Way, West Palm Beach, Florida 33407.

# ITT LSI SYSTEMS SUPPORT CENTER

An Equal Opportunity Employer, M/F

### Job-Seekers:

## Be the first to know with McGraw-Hill's **Advance Job Listings**

By having our new weekly **ADVANCE JOB LISTINGS** sent First Class to your home every Monday, you can be the first to know about nation-wide openings you qualify for both in and out of your field.

This preprint of scheduled employment ads will enable you to contact anxious domestic and overseas recruitment managers **BEFORE** their advertisements appear in upcoming issues of 22 McGraw-Hill Publications.

To receive a free sample copy, plus information about our low subscription rates (from three months to 12), fill out and return the coupon below.

**ADVANCE JOB LISTINGS**  
P.O. BOX 900  
NEW YORK, N.Y. 10020

Please send a sample copy of **ADVANCE JOB LISTINGS** to:

Name \_\_\_\_\_

Address \_\_\_\_\_

City \_\_\_\_\_

State \_\_\_\_\_

Zip \_\_\_\_\_



## **Bendix, Kansas City Division**

has challenging positions in the following areas:

**Electrical/Electronic — MSEE or BSEE required**

Experience in:

- Development and manufacture of electrical assemblies, cables and interconnecting devices.
- Industrial Control Systems including N/C, DNC and CNC applications. Familiarity with minicomputer and microprocessor hardware desired.
- Thin and thick film microcircuit manufacturing.
- Electrical/electronic assemblies such as Unique Pulse Generators, Filter Packs and Electronic Controllers.
- Manufacture of magnetic devices, filters, power supplies, timers, radars, and telemetry devices.
- Semiconductor physics, microwaves and logic circuitry.

**Don't miss this chance**  
to participate in state-of-the art work.

For confidential consideration, send complete resume with salary history to:

**The Bendix Corporation  
Kansas City Division  
P. O. Box 303-XX  
Kansas City, Missouri 64141**

Attention: Professional Placement



**Kansas City  
Division**

An equal opportunity employer m/f

## **Why your resume should be in the Electronics Manpower Register**

Every engineer covets the job where he can contribute the most to his profession—and his family.

The Electronics Manpower Register, a computerized data bank containing the qualifications of career-conscious ELECTRONICS readers just like yourself, is our contribution to solving this problem of fitting the right engineer to the right job.

Here's how you'll benefit from having your resume on file:

- **It's absolutely free.** No charges or fees to you at any time.
- **The computer never forgets.** When your type of job comes up, it remembers you're qualified.
- **Service is nationwide.** You'll be considered for openings across the U.S.
- **Your identity is protected.** Your resume is carefully screened to be sure it will not be sent to your company or parent organization.

That's why it makes sense for you to take advantage of the Electronics Manpower Register. To do so, just mail your resume to:

**ELECTRONICS  
MANPOWER  
REGISTER**

**P.O. Box 900  
New York, N.Y. 10020**



ADAC	40	Electronic Navigation Industries	3rd C
Adret Electronique	43	EMR-Telemetry	173
Advanced Micro Devices	10-11	EM Laboratories, Inc.	131
Alco Electronics Products Inc.	184	Fairchild Systems Technology	62-63
Allen Bradley Company	24	Faultfinders Inc.	9
Allied Electronics	142	‡ Ferroxcube Corp.	54
American Optical Scientific Instrument Division	143	Figaro Engineering Inc.	182
■ AMP Incorporated	21	■ John Fluke Mfg. Co., Ltd.	129
‡ Ampere Electronics Corporation	157	‡ Fujitsu Limited	48
‡ Analog Devices Inc.	84-85	GCA / David W. Mann	64
Anritsu Electric Co., Ltd.	146	General Instrument Corporation, Microelectronics Division	37
Applied Film Labs	184	‡ GenRad	155
Ballantine Laboratories	67	Grayhill Inc.	70
‡ Beckman Instruments Inc. Helipot Division	149	Guildline Instruments Inc.	135
• Beckman Instruments Ltd.	7E, 10E	■ Hewlett-Packard	2nd Cover, 1, 2, 18, 19, 60, 61, 166, 167, 184
Boshert Associates	168	Hitachi, Ltd.	144
■ Bourns Inc.	4th C	Houston Instruments	122
• Burr Brown Research Inc.	158	ILC Data Devices	27
Bussman Mfg. Division of McGraw Edison Co.	133	Infotek Systems	73
Byte Publications Inc.	76	Intel-Microcomputer Components	41
California Computer Products	151	‡ International Importers Inc.	52
Calex Mfg., Inc.	152	■ Johanson Manufacturing Corporation	20
Centralab USCC	68	Key Elemetrics Corp.	136
Cermaseal	152	Kedman Company	138
■ Cherry Electrical Products Inc.	79	‡ Kollmorgen Corp. Photocircuits Div.	82-83
Computer Professionals Book Club	168A, 168B, 169	Krohn Hite Corporation	5
Continental Connector Corp.	137	⚡ Marconi Instruments	164
Continental Rentals	8	• Marconi Instruments Ltd.	9E
Corning Glass Works, Mecor Div.	158-159	MCL Inc.	140
‡ CTI-Cryogenics	139	MDB Systems	71
‡ Cutler-Hammer Inc.	161	MFE Corporation	160
Dana Laboratories	148	Micro Networks Corporation	145
‡ Data General Corporation	44-45	Micro Switch Division of Honeywell	57
Data Translation Inc.	76	Micro Technical Industries	170
Delta Air Lines	165	Monolithic Memories Inc.	30
Deltron	130	■ Motorola Semiconductor Products Inc.	106
■ Dialight Corporation	162	National Semiconductor Corporation	46, 47
‡ Digital Equipment Corporation (Components)	80-81	Neff Instruments Corp.	141
Dionica	154	■ Non-Linear Systems	136
DIT-MCO	16	OK Machine & Tool Company	171
ECD Corporation	121	Opto 22	132
E. I. DuPont De Nemours & Co. Inc.	147	Optron, Inc.	14
Electronic Arrays	13	• Oscilloquartz	52
Electro Scientific Industries	134	• Philips ELA	172
Electronic Memories & Magnetics	155	Philips Elcoma	54, 5E
		‡ Philips Test & Measuring Instruments Inc.	153

# ELECTRONICS REPRINTS

No. of copies wanted

## New reprints

- \_\_\_ R-703 Special report—memories 16 pp \$3.00
- \_\_\_ R-702 World market report 1977 24 pp \$4.00
- \_\_\_ R-616 Special issue—technology update \$4.00
- \_\_\_ R-614 Power supply choices for sophisticated designs 8 pp \$3.00
- \_\_\_ R-612 Fiber-optic communications special report 24 pp \$3.00
- \_\_\_ R-610 Special report on hybrid-circuit technology 19 pp \$3.00
- \_\_\_ R-606 Special issue—microprocessors \$4.00
- \_\_\_ R-526 How reliable are today's components 16 pp \$3.00

## Charts

- \_\_\_ R-516 Electronic symbols \$2.00
- \_\_\_ R-213 Electromagnetic spectrum (updated 1976) \$3.00
- \_\_\_ R-326 Optical spectrum (6-page report and chart) \$3.00

## Books

- \_\_\_ R-704 Thermal design in electronics \$5.00
- \_\_\_ R-701 Applying microprocessors—Electronics Book Series \$9.95
- \_\_\_ R-608 Basics of Data Communications—Electronics Book Series \$12.50
- \_\_\_ R-602 Large Scale Integration—Electronics Book Series \$9.95
- \_\_\_ R-520 Microprocessors—Electronics Book Series \$8.95
- \_\_\_ R-011 Computer-aided Design 135 pp \$4.00
- \_\_\_ R-032 Active Filters 88 pp \$4.00
- \_\_\_ R-031 Circuit Designer's Casebook 182 pp \$5.50 (outside U.S. \$12.00)

## Payment must accompany your order

Make check or money order payable to Electronics Reprints. All orders are shipped prepaid by parcel post. Allow two to three weeks for delivery.

Mail your order to:

Janice Austin  
ELECTRONICS REPRINTS  
P.O. Box 669  
Hightstown, N.J. 08520

Back issues now available:

1960 to 1969, \$5.00 each  
1970 to 1973, \$3.00 each  
1974 to 1976, \$4.00 each

## RF & MICROWAVE SOURCES INFRA-RED, LF, UHF and VHF

**RADAR SYSTEMS:** 150 MHZ to 35 GHz

**AUTOTRACK ANTENNA MOUNTS:** Nike Hercules, Nike Ajax, SCR 584. Capacity 50 lbs. to 10,000 lbs. Light Airborne to Sage Systems

**RADAR INDICATORS:** PPI-RHI-A/B/C/Scopes

**PULSE MODULATORS:** 25KW to 10 Megawatts

**HIGH VOLTAGE POWER SUPPLIES:** Up to 20KV 2A

**MICROWAVE TUBES:** TWT, Klystron, BWO, Carcinatron, Magnetron Every Frequency

**MICROWAVE COMPONENTS  
SONAR SYSTEMS**

SEND FOR FREE 24 PAGE  
CATALOG ON YOUR LETTERHEAD



**RADIO RESEARCH  
INSTRUMENT CO. INC.**

2 LAKE AVE. EXT., DANBURY, CT. 08610  
203-792-6666

Circle 182 on reader service card

**Think of what  
just one company  
can do to stop  
pollution.  
We have.**



**People start pollution.  
People can stop it.**

Please send me a free copy of your guide.

Name \_\_\_\_\_

Street \_\_\_\_\_

City \_\_\_\_\_

State \_\_\_\_\_ Zip \_\_\_\_\_



A Public Service of  
The Magazine &  
The Advertising Council

**Keep America Beautiful**  
99 Park Avenue New York 10016

• Philips Test & Measuring Instruments	44,45
Precision Monolithics Inc.	15
Process Computer Systems, Inc.	163
Projects Unlimited Inc.	71
• Racal Tharmionic Ltd.	83
RCA Electro-optics and Devices	11E
RCA Solid State Division	7,39
Robinson Nugent Inc.	86-87
T.L. Robinson Company Inc.	138
Rockland Systems	42
Rockwell Microelectronic Device Division	28,29
• Rohde & Schwarz	1E
Rolm Corporation	125
Sangamo Data Recorder	112
• Schlumberger	48
• SDSA	15E
• S.E. Labs. (EMI) Ltd.	12E
• Sfernice	2E
Simpson Electric Company	123
Sprague Electric Company	51
Standard Microsystems Corp.	77
Systron Donner Concord Instrument	118
■ Tektronix Inc.	22,23,126,127
Thick Film Systems Inc.	170
T-K Enterprises	170
• Trio Kenwood Corp.	85
United Systems Corp. a Sub of Monsanto Co.	6
Varian Data Machine	58-59
■ Wavetek Indiana Inc.	88
S.S. White	152
Wintek Corp.	156
Yellow Springs Instrument Corp.	150
Zilog	17

### Classified and employment advertising

F. J. Eberle, Manager 212-997-2557

Arcinc Research Corp.	179
Aramco Services Co.	158
Atomic Personnel Inc.	180
Bendix Corp.	182
Courier Terminal Systems	178
Diebold	178
General Dynamics, Pomona Div.	161
Hughes Aircraft Co.	179
ITT LSI System Support Center	181
LRK	180
Lowe M. David	177
NCR Microelectronics Div.	176
P.B. Consultants	176
Probe-Tech	176
Schlumberger	177
Tektronix	178

- For more information of complete product line see advertisement in the latest Electronics Buyers Guide
- \* Advertisers in Electronics International
- ‡ Advertisers in Electronics domestic edition

### Advertising Sales Staff

#### Advertising sales manager: Paul W. Reiss

1221 Avenue of the Americas, New York, N.Y. 10020  
[212] 997-4371

**Atlanta, Ga. 30309:** Glen N. Dougherty  
100 Colony Square, 1175 Peachtree St., N.E.  
[404] 892-2868

**Boston, Mass. 02116:** Frank Mitchell  
607 Boylston St.  
[617] 262-1160

**Chicago, Ill. 60611**

645 North Michigan Avenue  
Robert W. Bartlett [312] 751-3739  
Robert M. Denmead [312] 751-3738

**Cleveland, Ohio 44113:** William J. Boyle  
[716] 586-5040

**Dallas, Texas 75201:** Albert J. Liedel  
2001 Bryant Tower, Suite 1070  
[214] 742-1747

**Denver, Colo. 80203:** Harry B. Doyle, Jr.  
123 Speer Blvd. #400  
[303] 837-1010

**Detroit, Michigan 48202:** Robert W. Bartlett  
1400 Fisher Bldg.  
[313] 873-7410

**Houston, Texas 77002:** Albert J. Liedel  
601 Jefferson Street, Dresser Tower  
[713] CA 4-8381

**Los Angeles, Calif. 90010:** Robert J. Rielly  
Bradley K. Jones, 3200 Wilshire Blvd., South Tower  
[213] 487-1160

**Minneapolis, Minn. 55435:** Robert M. Denmead  
4015 W. 65th St.  
[312] 751-3738

**New York, N.Y. 10020**

1221 Avenue of the Americas  
Michael J. Stoller [212] 997-3616  
Matthew T. Reseska [212] 997-3617

**Philadelphia, Pa. 19102:** Matthew T. Reseska  
Three Parkway  
[212] 997-3617

**Pittsburgh, Pa. 15222:** Matthew T. Reseska  
4 Gateway Center  
[212] 997-3617

**Rochester, N.Y. 14534:** William J. Boyle  
1175 Pittsford-Victor Rd., Pittsford, N.Y.  
[716] 586-5040

**San Francisco, Calif. 94111:** Don Farris  
Robert J. Rielly, 425 Battery Street,  
[415] 362-4600

**Paris:** Alain Offergeld  
17 Rue-Georges Bizet, 75116 Paris, France  
Tel: 720-73-01

**Geneva:** Alain Offergeld  
1 rue du Temple, Geneva, Switzerland  
Tel: 32-35-63

**United Kingdom & Scandinavia:** Robert Ghey  
34 Dover Street, London W1  
Tel: 01-493-1451

**Scandinavia:** Andrew Karnig and Assoc.  
Kungsholmsgatan 10  
112 27 Stockholm, Sweden  
Tel: 08 51 68 70 Telex: 179 51

**Milan:** Luigi Rancati  
1 via Baracchini, Italy  
Phone 86-90-656

**Brussels:** Alain Offergeld  
23 Chaussee de Wavre  
Brussels 1040, Belgium  
Tel: 13-73-95

**Frankfurt/Main:** Fritz Krusebecker  
Liebigstrasse 27c, Germany  
Phone 72 01 81

**Tokyo:** Tatsumi Katagiri, McGraw-Hill  
Publications Overseas Corporation,  
Kasumigaseki Building 2-5, 3-chome,  
Kasumigaseki, Chiyoda-Ku, Tokyo, Japan  
[581] 9811

**Australasia:** Warren E. Ball  
IPO Box 5106, Tokyo, Japan

### Business Department

**Thomas M. Egan,**  
Production Manager [212] 997-3140

**Gayla Black**  
Production Manager [212] 997-2044

**Carol Gallagher**  
Production Manager International  
[212] 997-2045

**Dorothy Carter**  
Production Manager Domestic  
[212] 997-2908

**Frances Vallone**  
Reader Service Manager  
[212] 997-6057

### Electronics Buyers' Guide

**H.T. Howland,** General Manager  
[212] 997-6642

**Regina Hera,** Directory Manager  
[212] 997-2544

**Gayla Black,** Production Manager  
[212] 997-2044

### Classified and Employment Advertising

**Frank Eberle,** Manager  
[212] 997-2557

# FEATURE ARTICLES FROM *ELECTRONICS* AVAILABLE IN REPRINT FORM

No. of  
copies  
wanted

## New reprints

- \_\_\_ R-703 Special report—memories 16 pp \$3.00
- \_\_\_ R-702 World market report 1977 24 pp \$4.00
- \_\_\_ R-616 Special issue—technology update \$4.00
- \_\_\_ R-614 Power supply choices for sophisticated designs 8 pp \$3.00
- \_\_\_ R-612 Fiber-optic communications special report 24 pp \$3.00
- \_\_\_ R-610 Special report on hybrid-circuit technology 19 pp \$3.00
- \_\_\_ R-606 Special issue—microprocessors \$4.00
- \_\_\_ R-526 How reliable are today's components 16 pp \$3.00

## Charts

- \_\_\_ R-516 Electronic symbols \$2.00
- \_\_\_ R-213 Electromagnetic spectrum (updated 1976) \$3.00
- \_\_\_ R-326 Optical spectrum (6-page report and chart) \$3.00

## Books

- \_\_\_ R-704 Thermal design in electronics \$5.00
- \_\_\_ R-701 Applying microprocessors—Electronics Book Series \$9.95
- \_\_\_ R-608 Basics of Data Communications—Electronics Book Series \$12.50
- \_\_\_ R-602 Large Scale Integration—Electronics Book Series \$9.95
- \_\_\_ R-520 Microprocessors—Electronics Book Series \$8.95
- \_\_\_ R-011 Computer-aided Design 135 pp \$4.00
- \_\_\_ R-032 Active Filters 88 pp \$4.00
- \_\_\_ R-031 Circuit Designer's Casebook 182 pp \$5.50 (outside U.S. \$12.00)

## Other Reprints

- \_\_\_ R-600 World market report 1976 24 pp \$4.00
- \_\_\_ R-524 Special report on bipolar large-scale integration 12 pp \$3.00
- \_\_\_ R-522 Special report on power semiconductors 12 pp \$3.00
- \_\_\_ R-518 Special issue—productivity \$4.00
- \_\_\_ R-514 Eight ways to better radio receiver design 6 pp \$3.00
- \_\_\_ R-512 Design of circuits for dangerous environments 4 pp \$2.00
- \_\_\_ R-510 Bipolar integration advances with PL microprocessor 8 pp \$2.00
- \_\_\_ R-508 Designing microprocessors with standard logic 12 pp \$3.00
- \_\_\_ R-506 The case for component burn-in 7 pp \$2.00
- \_\_\_ R-434 Designing automated systems with the new standard interface 12 pp \$3.00
- \_\_\_ R-432 An update on communications satellites 8 pp \$2.00
- \_\_\_ R-430 Choosing the right bipolar transistor model for computer-aided design 20 pp \$3.00
- \_\_\_ R-428 Designing with low-cost lasers 6 pp \$2.00
- \_\_\_ R-424 Microprocessor applications 28 pp \$3.00
- \_\_\_ R-422 A microprogramable minicomputer 8 pp \$2.00
- \_\_\_ R-420 Computerized text-editing and typesetting 8 pp \$2.00
- \_\_\_ R-418 Computer analyses of rf circuits 8 pp \$2.00
- \_\_\_ R-414 The ion-implanted n-channel process 6 pp \$2.00
- \_\_\_ R-412 Liquid cooling of power semiconductors 6 pp \$2.00
- \_\_\_ R-410 Special report on passive components 16 pp \$3.00
- \_\_\_ R-406 Designing with the new logic, C-MOS and bipolar 16 pp \$3.00
- \_\_\_ R-324 Semiconductor memories are taking over data-storage applications 16 pp \$3.00
- \_\_\_ R-322 Special report: new displays complement old 10 pp \$2.00
- \_\_\_ R-320 Special report on designing with flat cable 14 pp \$3.00
- \_\_\_ R-318 Special report on auto electronics 16 pp \$3.00
- \_\_\_ R-316 Hybrid circuits solve tough design problems 16 pp \$3.00
- \_\_\_ R-310 Penetration color tubes are enhancing information displays 6 pp \$2.00
- \_\_\_ R-308 Program for transition from non-linear to linear transistor model 6 pp \$2.00
- \_\_\_ R-306 Charge-coupling improves its image, challenging video camera tubes 8 pp \$2.00
- \_\_\_ R-211 Electromagnetic spectrum 16-page report \$2.00
- \_\_\_ R-209 Semiconductor RAMs land computer mainframe jobs 15 pp \$2.00
- \_\_\_ R-207 Technology gap starts to close for computer peripherals 16 pp \$3.00
- \_\_\_ R-205 Bridging the analog and digital worlds with linear ICs 16 pp \$3.00
- \_\_\_ R-133 Optoelectronics makes it at last 34 pp \$4.00
- \_\_\_ R-104 The new concept for memory and imaging: charge-coupling 12 pp \$2.00

## Payment must accompany your order

Make check or money order payable to Electronics Reprints. All orders are shipped prepaid by parcel post. Allow two to three weeks for delivery.

Back issues now available:  
1960 to 1969, \$5.00 each  
1970 to 1973, \$3.00 each  
1974 to 1976, \$4.00 each

## USE THIS PAGE AS YOUR ORDER FORM

Cost of orders \$ \_\_\_\_\_  
Plus 10% handling charge \$ \_\_\_\_\_  
TOTAL AMOUNT ENCLOSED \$ \_\_\_\_\_

Mail your order to:  
Janice Austin  
ELECTRONICS REPRINTS  
P.O. Box 669  
Hightstown, N.J. 08520

## SEND REPRINTS TO

Name \_\_\_\_\_  
Company \_\_\_\_\_ Dept. \_\_\_\_\_  
Street \_\_\_\_\_  
City \_\_\_\_\_ State \_\_\_\_\_ Zip \_\_\_\_\_

## WHEN YOU COMPARE PRICE... COMPARE FEATURES TOO!

**GREEN  
SERIES**

These premium features are standard on all ALCO Green Series switches. We ask you to investigate first, we're sure ALCOSWITCH is your best buy!

- ✓ **LEVER-STOP DEVICE**  
Prevents Push-In of Toggle
- ✓ **HI-TORQUE BUSHING**  
Withstands Mechanical Abuse
- ✓ **NEW FRAME DESIGN**  
Allows U.L. Listing 250V & 125V
- ✓ **CASE MATERIAL**  
High Temp Diallyl Phthalate
- ✓ **ISOLATION BARRIERS**  
Inside as well as Outside
- ✓ **FINE SILVER CONTACTS**  
Provides High 6 Amp Rating
- ✓ **MOLDED-IN TERMINALS**  
Eliminates Costly Epoxy Seals
- ✓ **GOLD FLASH**  
Prevents Oxidation of Terminals
- ✓ **NO HIDDEN COSTS**  
Investigate, You'll Buy Alcoswitch

MTF  
SERIES

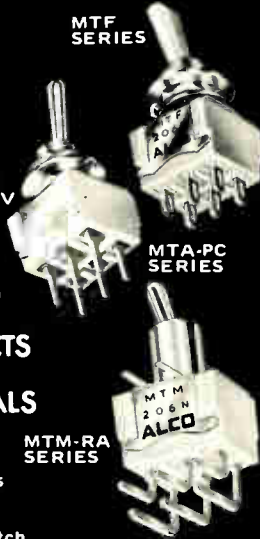

MTA-PC  
SERIES

MTM-RA  
SERIES

For further information, contact Mr. Tom Clark — (617) 685-4371.

**ALCO** ELECTRONIC PRODUCTS, INC.  
1561 OSGOOD STREET, NORTH ANDOVER, MA. 01845 U.S.A.

TEL (617) 685-4371

FAX 710 347-0332

A SUBSIDIARY OF

AUGAT<sup>®</sup> INC.

Circle 184 on reader service card

## LOOKING FOR TRANSPARENT CONDUCTIVE COATINGS WITH

- LOWER COST?
- FASTER, MORE UNIFORM  
ETCHING?
- LOWER RESISTANCE?

High-Rate Reactive Sputtering  
plus In-Line Vacuum Systems  
combine to provide any or all  
of these for:

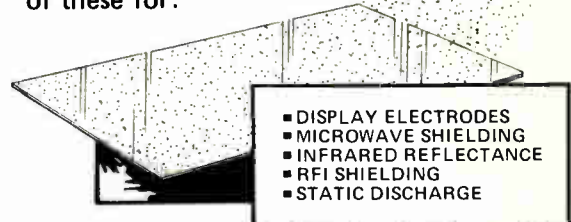

- DISPLAY ELECTRODES
- MICROWAVE SHIELDING
- INFRARED REFLECTANCE
- RFI SHIELDING
- STATIC DISCHARGE

Our family of transparent, electrically conductive thin films include a special suboxidized coating which etches uniformly in seconds using only dilute acid—and a film with a sheet resistance below 5 ohms per square. We also produce a variety of other thin films at low production costs. For more information or test samples geared to your particular use on your substrate size, write or call:



3275 Prairie Avenue  
Boulder, Colorado 80302  
(303) 449-6471

applied films lab

Record with Hewlett-Packard

## Hewlett-Packard XY's— when you need performance and reliability.

Hewlett-Packard builds precisely the right XY recorder for virtually every kind of data collection... with performance and reliability that lets you capture data just about wherever and whenever you want.

**HP PERFORMANCE:** Includes the optimum combination of pen acceleration and pen speed. Accelerations up to almost 10 Gs provide the big advantage that lets you record small rapid changes in data.

**HP RELIABILITY:** Rugged design provides long life under tough environmental conditions. Single mainframe castings in many models help assure positive, permanent alignment. Autogrip electrostatic hold-down puts a solid grip on the chart. And every recorder is supported by HP's worldwide sales and service network.

Performance and reliability are recognized HP traditions—25 years for XY's. And that's experience to draw from.

HEWLETT  PACKARD

1507 Page Mill Road, Palo Alto, California 94304

For assistance call: Washington (301) 948-6370, Chicago (312) 255-9800, Atlanta (404) 955-1500, Los Angeles (213) 877-1282

Circle 216 on reader service card



# Electronics Reader Service

For additional information on products advertised, new products or new literature, use these business reply cards.

Complete entire card. Please print or type.

Circle the number on the Reader Service postcard that corresponds to the number at the bottom of the advertisement, new product item, or new literature in which you are interested.

To aid the manufacturer in filling your request, please answer the three questions.

All inquiries from outside the U.S. that cannot reach Electronics before the expiration date noted on the Reader Service postcard must be mailed directly to the manufacturer. The manufacturer assumes all responsibilities for responding to inquiries.

### Subscriptions & Renewals

Fill in the subscription card adjoining this card. Electronics will bill you at the address indicated on the card.

**Electronics** March 3, 1977 This Reader Service card expires May 17, 1977

NAME \_\_\_\_\_ TITLE \_\_\_\_\_  
 PHONE (\_\_\_\_\_) \_\_\_\_\_ COMPANY \_\_\_\_\_  
 STREET ADDRESS \_\_\_\_\_  
 CITY \_\_\_\_\_ COUNTRY \_\_\_\_\_

#### Industry classification (check one):

- a Computer & Related Equipment  
 b Communications Equipment & Systems  
 c Navigation, Guidance or Control Systems  
 d Aerospace, Underseas Ground Support  
 e Test & Measuring Equipment  
 f Consumer Products  
 g Industrial Controls & Equipment  
 h Components & Subassemblies  
 j Independent R&D Organizations  
 k Government

#### Your design function (check each letter that applies):

- x I do electronic design or development engineering work.  
 y I supervise electronic design or development engineering work.  
 z I set standards for, or evaluate electronic components, systems and materials.

#### Estimate number of employees (at this location): 1. under 20 2. 20-99 3. 100-999 4. over 1000

1 16 31 46	61 76 91 106	121 136 151 166	181 196 211 226	241 256 271 348	363 378 393 408	423 438 453 468	483 498 703 718
2 17 32 47	62 77 92 107	122 137 152 167	182 197 212 227	242 257 272 349	364 379 394 409	424 439 454 469	484 499 704 719
3 18 33 48	63 78 93 108	123 138 153 168	183 198 213 228	243 258 273 350	365 380 395 410	425 440 455 470	485 500 705 720
4 19 34 49	64 79 94 109	124 139 154 169	184 199 214 229	244 259 274 351	366 381 396 411	426 441 456 471	486 501 706 900
5 20 35 50	65 80 95 110	125 140 155 170	185 200 215 230	245 260 275 352	367 382 397 412	427 442 457 472	487 502 707 901
6 21 36 51	66 81 96 111	126 141 156 171	186 201 216 231	246 261 338 353	368 383 398 413	428 443 458 473	488 503 708 902
7 22 37 52	67 82 97 112	127 142 157 172	187 202 217 232	247 262 339 354	369 384 399 414	429 444 459 474	489 504 709 951
8 23 38 53	68 83 98 113	128 143 158 173	188 203 218 233	248 263 340 355	370 385 400 415	430 445 460 475	490 505 710 952
9 24 39 54	69 84 99 114	129 144 159 174	189 204 219 234	249 264 341 356	371 386 401 416	431 446 461 476	491 506 711 953
10 25 40 55	70 85 100 115	130 145 160 175	190 205 220 235	250 265 342 357	372 387 402 417	432 447 462 477	492 507 712 954
11 26 41 56	71 86 101 116	131 146 161 176	191 206 221 236	251 266 343 358	373 388 403 418	433 448 463 478	493 508 713 956
12 27 42 57	72 87 102 117	132 147 162 177	192 207 222 237	252 267 344 359	374 389 404 419	434 449 464 479	494 509 714 957
13 28 43 58	73 88 103 118	133 148 163 178	193 208 223 238	253 268 345 360	375 390 405 420	435 450 465 480	495 510 715 958
14 29 44 59	74 89 104 119	134 149 164 179	194 209 224 239	254 269 346 361	376 391 406 421	436 451 466 481	496 701 716 959
15 30 45 60	75 90 105 120	135 150 165 180	195 210 225 240	255 270 347 362	377 392 407 422	437 452 467 482	497 702 717 960

**Electronics** March 3, 1977 This Reader Service card expires May 17, 1977

NAME \_\_\_\_\_ TITLE \_\_\_\_\_  
 PHONE (\_\_\_\_\_) \_\_\_\_\_ COMPANY \_\_\_\_\_  
 STREET ADDRESS \_\_\_\_\_  
 CITY \_\_\_\_\_ COUNTRY \_\_\_\_\_

#### Industry classification (check one):

- a Computer & Related Equipment  
 b Communications Equipment & Systems  
 c Navigation, Guidance or Control Systems  
 d Aerospace, Underseas Ground Support  
 e Test & Measuring Equipment  
 f Consumer Products  
 g Industrial Controls & Equipment  
 h Components & Subassemblies  
 j Independent R&D Organizations  
 k Government

#### Your design function (check each letter that applies):

- x I do electronic design or development engineering work.  
 y I supervise electronic design or development engineering work.  
 z I set standards for, or evaluate electronic components, systems and materials.

#### Estimate number of employees (at this location): 1. under 20 2. 20-99 3. 100-999 4. over 1000

1 16 31 46	61 76 91 106	121 136 151 166	181 196 211 226	241 256 271 348	363 378 393 408	423 438 453 468	483 498 703 718
2 17 32 47	62 77 92 107	122 137 152 167	182 197 212 227	242 257 272 349	364 379 394 409	424 439 454 469	484 499 704 719
3 18 33 48	63 78 93 108	123 138 153 168	183 198 213 228	243 258 273 350	365 380 395 410	425 440 455 470	485 500 705 720
4 19 34 49	64 79 94 109	124 139 154 169	184 199 214 229	244 259 274 351	366 381 396 411	426 441 456 471	486 501 706 900
5 20 35 50	65 80 95 110	125 140 155 170	185 200 215 230	245 260 275 352	367 382 397 412	427 442 457 472	487 502 707 901
6 21 36 51	66 81 96 111	126 141 156 171	186 201 216 231	246 261 338 353	368 383 398 413	428 443 458 473	488 503 708 902
7 22 37 52	67 82 97 112	127 142 157 172	187 202 217 232	247 262 339 354	369 384 399 414	429 444 459 474	489 504 709 951
8 23 38 53	68 83 98 113	128 143 158 173	188 203 218 233	248 263 340 355	370 385 400 415	430 445 460 475	490 505 710 952
9 24 39 54	69 84 99 114	129 144 159 174	189 204 219 234	249 264 341 356	371 386 401 416	431 446 461 476	491 506 711 953
10 25 40 55	70 85 100 115	130 145 160 175	190 205 220 235	250 265 342 357	372 387 402 417	432 447 462 477	492 507 712 954
11 26 41 56	71 86 101 116	131 146 161 176	191 206 221 236	251 266 343 358	373 388 403 418	433 448 463 478	493 508 713 956
12 27 42 57	72 87 102 117	132 147 162 177	192 207 222 237	252 267 344 359	374 389 404 419	434 449 464 479	494 509 714 957
13 28 43 58	73 88 103 118	133 148 163 178	193 208 223 238	253 268 345 360	375 390 405 420	435 450 465 480	495 510 715 958
14 29 44 59	74 89 104 119	134 149 164 179	194 209 224 239	254 269 346 361	376 391 406 421	436 451 466 481	496 701 716 959
15 30 45 60	75 90 105 120	135 150 165 180	195 210 225 240	255 270 347 362	377 392 407 422	437 452 467 482	497 702 717 960

# Electronics Reader Service

If the cards below have already been used,  
you may obtain the needed information  
by writing directly to the manufacturer,  
or by sending your name and address,  
plus the Reader Service number and issue date,  
to Electronics Reader Service Department,  
P.O. Box No. 2530, Clinton, Iowa 52732, U.S.A.

Place correct airmail  
postage here . . . for  
faster service.

## Electronics

P.O. Box No. 2530  
Clinton, Iowa 52732  
U.S.A.

Place correct airmail  
postage here . . . for  
faster service.

## Electronics

P.O. Box No. 2530  
Clinton, Iowa 52732  
U.S.A.

*Tomorrow ideas today.*



Using solid-state technology to replace bulky tube-type equipment, ENI's broadband amplifiers are tomorrow ideas available today. ENI's Class A power amplifiers already cover the frequency spectrum of 10 kHz to 1 GHz, with power outputs ranging from 300 milliwatts to over 4000 watts. And we're still climbing. Driven by any signal generator, frequency synthesizer or sweeper, ENI's compact portable amplifiers are completely broadband and untuned. Amplifying inputs of AM, FM, SSB, TV and pulse modulations with minimum distortion, these rugged units are

versatile power sources for general laboratory work, RFI/EMI testing, signal distribution, RF transmission, laser modulation, data transmission, NMR, ultrasonics and more. Designed to be unconditionally stable and failsafe (impervious to severe load conditions including open or short circuit loads), ENI power amplifiers will deliver their rated power to any load, regardless of match. For information write: ENI, 3000 Winton Rd. So., Rochester, New York 14623. Call 716-473-6900. TELEX 97-8283 ENI ROC.

**ENI**

*World's Leader in Solid State Power Amplifiers*

Circle 901 on reader service card  
World Radio History

# The \$2 Pot with the \$5 Linearity...



**COMPARISON OF DIAL SETTING ACCURACY**  
(Possible production variation — unit to unit)

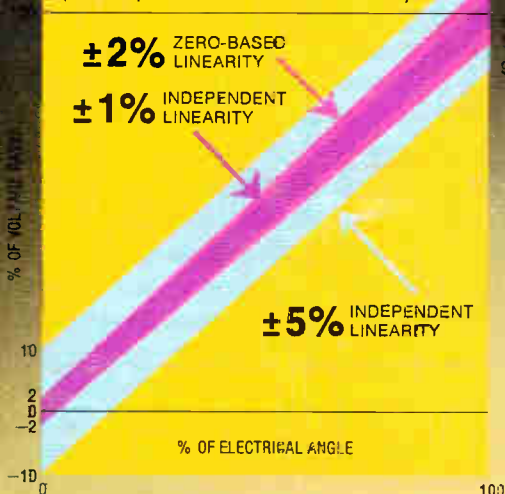

PERFORMANCE/COST COMPARISON			
Type	Element	Linearity	Approx. Cost
HIGHER COST PRECISION POTS	Conductive Plastic	±1% Independent	\$5.00
BOURNS 87/88 SEMI-PRECISION POTENTIOMETERS	Conductive Plastic	±2% Zero-Based	\$2.00
	Cermet	±2.5% Zero-Based	
LOWER COST CONTROLS	Conductive Plastic/Cermet	±5 - 10% Independent	\$1.00

## Your alternative to lower performance controls and higher cost precisions.

### LASER-TRIMMED SAVINGS

Now, for about \$2\*, the Bourns® Model 87/88 semi-precision, single-turn potentiometer delivers ±2% zero-based linearity. Compare the accuracy to the \$5 precision pot with ±1% independent linearity that you're buying now . . . especially the performance at the low end setting, where dial setting accuracy is most critical. Laser trimming and advanced element design† deliver performance and savings in a 5/8" square modular package.

### MOVE UP FROM INDUSTRIAL GRADE CONTROLS

Again, for about \$2, the Model 87/88 offers 200-300% greater panel setting accuracy over industrial grade controls. They're perfect for applications requiring close, consistent calibration of output-to-panel setting and versatility of design.

### MODEL 87/88 — THE ALTERNATIVE

Don't compromise your application with lower performance controls or pay a premium for precision pots. Specify the alternative — Bourns Model 87/88. Write or call today for complete technical information.

**\$2 SEMI-PRECISION MODULAR POTS . . . BEAUTIFUL!**

**TRIMPOT PRODUCTS DIVISION, BOURNS, INC., 1200 Columbia Avenue, Riverside, California 92507, Telephone (714) 781-5122 — TWX 910 332-1252.**

\* Production quantities, Domestic U.S.A. price, Single unit only.  
† Patent Pending



International Marketing Offices: European Headquarters — Switzerland 042/23 22 42 • Belgium 02/218 2005 • France 01/2039633 • Germany 0711/24 29 36 • Italy 02/32 55 86 • Netherlands 70/87 44 00 • United Kingdom 01/572 6531 • Norway 2/71 18 72 • Sweden 764/20 110 • Japan 03/921 9111 • Australia 02/55-0411 03/95-9566 • Israel 77 71 15/6/7

Circle 902 on reader service card

World Radio History